









DORMER  PRAMET

**MAINTENANCE
AND REPAIR**

2022



 **DORMER**

 2		INTRODUCTION
 4		WMG & ISO 13399
 7		SOLID CARBIDE DRILLS & HSS DRILLS
 82		REAMERS & COUNTERSINKS
 133		HSS TAPS
 190		DIES
 208		SOLID HM & HSS MILLS
 253		ROTARY BURRS
 329		CUTTING FLUIDS

Maintenance and repair operations (MRO) represent a vast number of applications across all engineering segments, requiring a broad range of cutting tools. This is critical to keeping equipment and plant operational.

Dormer Pramet manufactures a comprehensive program of products that can be used in an MRO environment, making our company an ideal first choice for all your needs.

Product applications include holemaking, threading, milling, reaming, countersinking and deburring.

Also, MRO applications require the right tool at the right time. Reliable solutions are critical for “first-time” success and reducing machine down times.

Dormer Pramet is a full-service supplier and committed to assisting our customers in implementing their machining processes efficiently, with productivity as our goal.

For further information regarding our assortment of MRO cutting tools, please contact your local Dormer Pramet sales office or speak with our official distributor in your area. Alternatively, please visit www.dormerpramet.com.



SOLID ROUND TOOLS - CONTENT

PRODUCT FAMILY		PRODUCT FAMILY		PRODUCT FAMILY		PRODUCT FAMILY	
A		C247	223	G149	114	P707	292
A002	28	C273	225	G154	117	P709	293
A002S	30	C305	221	G171	118	P711	294
A022	26	C306	220	G236	122	P713	295
A087	66	C400	228	G314	121	P715	296
A088	64	C403	229	G338	120	P721	297
A089	67	C407	227	G506	112	P801	268
A094	66	E		G560	110	P801C	269
A095	65	E100	142	G570	111	P803	270
A100	18	E101	145	G600	109	P803C	271
A108	31	E102	144	L		P805	272
A110	22	E105	146	L000	185	P805C	273
A117	33	E108	149	L001	186	P807	274
A119	44	E111	150	L002	187	P807C	275
A120	16	E115	151	L110	205	P809	276
A123	43	E119	152	L112	180	P811	277
A124	37	E500	154	L115	182	P811C	278
A125	24	E513	158	L119	184	P813	279
A130	48	E515	162	L120	181	P813C	280
A160	38	E524	164	L126	183	P815	281
A166	61	E531	166	M		P815C	282
A170	46	E536	168	M150	62	P817	286
A188	70	E542	170	M152	63	P819	287
A190	68	E547	172	M200-1	330	P821	283
A191	69	E620	174	M200-2	330	P821C	284
A295	70	E621	175	M200-3	331	P823	285
A345	56	E650	176	P		P825	288
A350	54	E651	177	P100	323	P831	306
A530	58	E653	179	P101	324	P833	307
A723	45	E654	178	P501	312	P835	308
A730	59	F		P505	313	P837	309
A777	35	F202	201	P507	314	P841	310
B		F272	204	P509	315	P842	311
B100	90	F300	196	P511	316	P843	321
B101	99	F302	202	P513	317	P844	322
B121	98	F310	197	P515	318	P880	325
B122	97	F312	203	P521	319	P890	326
B161	101	F320	198	P523	320	R	
B301	94	F330	199	P601	298	R100	41
B334	92	F370	200	P605	299	R120	39
B335	93	G		P607	300	S	
B903	95	G106	107	P609	301	S902	230
B952	96	G107	108	P611	302	S903	232
B955	102	G129	113	P613	303	S904	234
B956	103	G132	115	P615	304	S922	231
B957	104	G135	116	P621	305	S933	233
C		G136	105	P701	289	S944	235
C110	216	G138	119	P703	290	S991	236
C123	218	G142	106	P705	291		

WORKPIECE MATERIAL GROUPS (WMG)

ISO To select a cutting grade and geometry for a broad range of workpiece materials

General definition

i.e. Steel, Stainless Steel...

P **M** **K** **N** **S** **H**

Subgroup To navigate and select a tool by suitability for a more specific range of workpiece materials

Definition by structure/composition

i.e. Plain Carbon Steel, Alloy Steel...

P **M** **K** **N** **S** **H**

P1

P2

P3

P4

WMG To select and provide cutting conditions within a bandwidth of $\pm 10\%$

Definition by hardness/ultimate tensile strength

i.e. $160 < 220 \text{ HB}$, $620 < 900 \text{ N/mm}^2 \dots$

P

P1

P1.1

P1.2

P1.3

P2

P2.1

P2.2

P2.3

P3

P3.1

P3.2

P3.3

P4

P4.1

P4.2

P4.3

ABOUT DORMER PRAMET'S WORKPIECE MATERIAL CLASSIFICATION

Workpiece Material Groups (WMG) are used to support easy and reliable selection of the right cutting tool and starting values for machining conditions in particular applications.

Dormer Pramet classifies workpiece materials into six different coloured groups;

- **Blue:** Steel and cast steel (P-group)
- **Yellow:** Stainless steel (M-group)
- **Red:** Cast iron (K-group)
- **Green:** Non-ferrous metals (N-group)
- **Brown:** High-temperature alloys (S-group)
- **Grey:** Hardened materials (H-group)

Each of these are divided into subgroups on the basis of their structure and/or composition. For example, P-group steel and cast steel is split into four subgroups, namely;

- **P1** – Free machining steel
- **P2** – Plain carbon steel
- **P3** – Alloy steel
- **P4** – Tool steel

A final division includes material properties, such as hardness and ultimate tensile strength. This is to provide our customers with a complete tool recommendation, including starting values for cutting speed and feed.

The table on the next page includes a description of each workpiece material group, as well as examples of commonly used designations.



WMG (WORK MATERIAL GROUP)

ISO group	WMG (Work Material Group)		Hardness (HB or HRC)	Ultimate Tensile Strength (MPa)				
P	P1	P1.1	Sulfurized	< 240 HB	≤ 830			
		P1.2	Free machining steel	Sulfurized and phosphorized	< 180 HB	≤ 620		
		P1.3	(carbon steels with increased machinability)	Sulfurized/phosphorized and leaded	< 180 HB	≤ 620		
	P2	P2.1	Plain carbon steel (steels comprised of mainly iron and carbon)	Containing <0.25 % C	< 180 HB	≤ 620		
		P2.2		Containing <0.55 % C	< 240 HB	≤ 830		
		P2.3		Containing >0.55 % C	< 300 HB	≤ 1030		
	P3	P3.1	Alloy steel (carbon steels with an alloying content ≤ 10%)	Annealed	< 180 HB	≤ 620		
		P3.2		Hardened and tempered	180 – 260 HB	> 620 ≤ 900		
		P3.3			260 – 360 HB	> 900 ≤ 1240		
	P4	P4.1	Tool steel (special alloy steel for tools, dies and molds)	Annealed	< 26 HRC	≤ 900		
P4.2		Hardened and tempered		26 – 39 HRC	> 900 ≤ 1240			
P4.3				39 – 45 HRC	> 1240 ≤ 1450			
M	M1	M1.1	Ferritic stainless steel (straight chromium non-hardenable alloys)	< 160 HB	≤ 520			
				160 – 220 HB	> 520 ≤ 700			
	M2	M2.1	Martensitic stainless steel (straight chromium hardenable alloys)	Annealed	< 200 HB	≤ 670		
				Quenched and tempered	200 – 280 HB	> 670 ≤ 950		
				Precipitation-hardened	280 – 380 HB	> 950 ≤ 1300		
	M3	M3.1	Austenitic stainless steel (chromium-nickel and chromium-nickel-manganese alloys)	< 200 HB	≤ 750			
				200 – 260 HB	> 750 ≤ 870			
				260 – 300 HB	> 870 ≤ 1040			
	M4	M4.1	Austenitic-ferritic (DUPLEX) or super-austenitic stainless steel	< 300 HB	≤ 990			
		M4.2	Precipitation hardening austenitic stainless steel	300 – 380 HB	≤ 1320			
K	K1	K1.1	Gray iron or Automotive Gray iron (GG) (iron-carbon castings with a lamellar graphite microstructure)	Ferritic or ferritic-pearlitic	< 180 HB	≤ 190		
				Ferritic-pearlitic or pearlitic	180 – 240 HB	> 190 ≤ 310		
				Pearlitic	240 – 280 HB	> 310 ≤ 390		
	K2	K2.1	Malleable iron (GTS/GTW) (iron-carbon castings with a graphite-free microstructure)	Ferritic	< 160 HB	≤ 400		
				Ferritic or pearlitic	160 – 200 HB	> 400 ≤ 550		
				Pearlitic	200 – 240 HB	> 550 ≤ 660		
	K3	K3.1	Ductile iron (GGG) (iron-carbon castings with a nodular graphite microstructure)	Ferritic	< 180 HB	≤ 560		
				Ferritic or pearlitic	180 – 220 HB	> 560 ≤ 680		
				Pearlitic	220 – 260 HB	> 680 ≤ 800		
	K4	K4.1	Austenitic gray iron (ASTM A436) (iron-carbon alloy castings with an austenitic lamellar graphite microstructure)	< 180 HB	≤ 190			
< 240 HB				≤ 740				
K4.2		Austenitic ductile iron (ASTM A439 or ASTM A571) (iron-carbon alloy castings with an austenitic nodular graphite microstructure)	< 280 HB	> 840 ≤ 980				
			280 – 320 HB	> 980 ≤ 1130				
			320 – 360 HB	> 1130 ≤ 1280				
K5	K5.1	Compacted graphite iron CGI (ASTM A842) (iron-carbon castings with a vermicular graphite structure)	Ferritic	< 180 HB	≤ 400			
			Ferritic-pearlitic	180 – 220 HB	> 400 ≤ 450			
			Pearlitic	220 – 260 HB	> 450 ≤ 500			
N	N1	N1.1	Commercially pure wrought aluminium	< 60 HB	≤ 240			
				N1.2	Wrought aluminium alloys	Half hard tempered	60 – 100 HB	> 240 ≤ 400
						Full hard tempered	100 – 150 HB	> 400 ≤ 590
	N2	N2.1	Cast aluminium alloys	< 75 HB	≤ 240			
				75 – 90 HB	> 240 ≤ 270			
				90 – 140 HB	> 270 ≤ 440			
	N3	N3.1	Free-cutting copper-alloys materials with excellent machining properties	–	–			
				N3.2	Short-chip copper-alloys with good to moderate machining properties	–	–	
						N3.3	Electrolytic copper and long-chip copper-alloys with moderate to poor machining properties	–
	N4	N4.1	Thermoplastic polymers	–	–			
N4.2				Thermosetting polymers	–	–		
					N4.3	Reinforced polymers or composites	–	–
N5	N5.1	Graphite	–	–				
			–	–				
S	S1	S1.1	Titanium or titanium alloys	< 200 HB	≤ 660			
				200 – 280 HB	> 660 ≤ 950			
				280 – 360 HB	> 950 ≤ 1200			
	S2	S2.1	Fe-based high-temperature alloys	< 200 HB	≤ 690			
				200 – 280 HB	> 690 ≤ 970			
	S3	S3.1	Ni-based high-temperature alloys	< 280 HB	≤ 940			
				280 – 360 HB	> 940 ≤ 1200			
	S4	S4.1	Co-based high-temperature alloys	< 240 HB	≤ 800			
240 – 320 HB				> 800 ≤ 1070				
H	H1	H1.1	Chilled cast iron	< 440 HB	–			
				< 55 HRC	–			
	H2	H2.1	Hardened cast iron	> 55 HRC	–			
				> 51 HRC	–			
	H3	H3.1	Hardened steel <55 HRC	51 – 55 HRC	–			
				55 – 59 HRC	–			
H4	H4.1	Hardened steel >55 HRC	> 59 HRC	–				
			–	–				

CUTTING TOOL PARAMETERS ACCORDING TO ISO 13399

All cutting tools are defined by a number of parameters according to the standard ISO 13399. This list contains all the parameters used in this catalogue and their definitions.

ISO 13399 is an international cutting tool information standard. It provides dimensions and parameters in a neutral format that is independent of any particular system or company nomenclature. When cutting tools are clearly defined according to a global standard, all types of software can process the electronic data more quickly, improving the quality of communication and helping to make the exchange of

information run smoothly. By supporting a common language in our cutting tool descriptions will assist this system to system communication. It will save you significant amount of time, providing an easier gathering of high-quality data across our 40,000 solid and indexable tools. By using a ISO 13399 compliant system, there will be no need to manually interpret data and key-enter it into your system.

EXAMPLES ONLY!

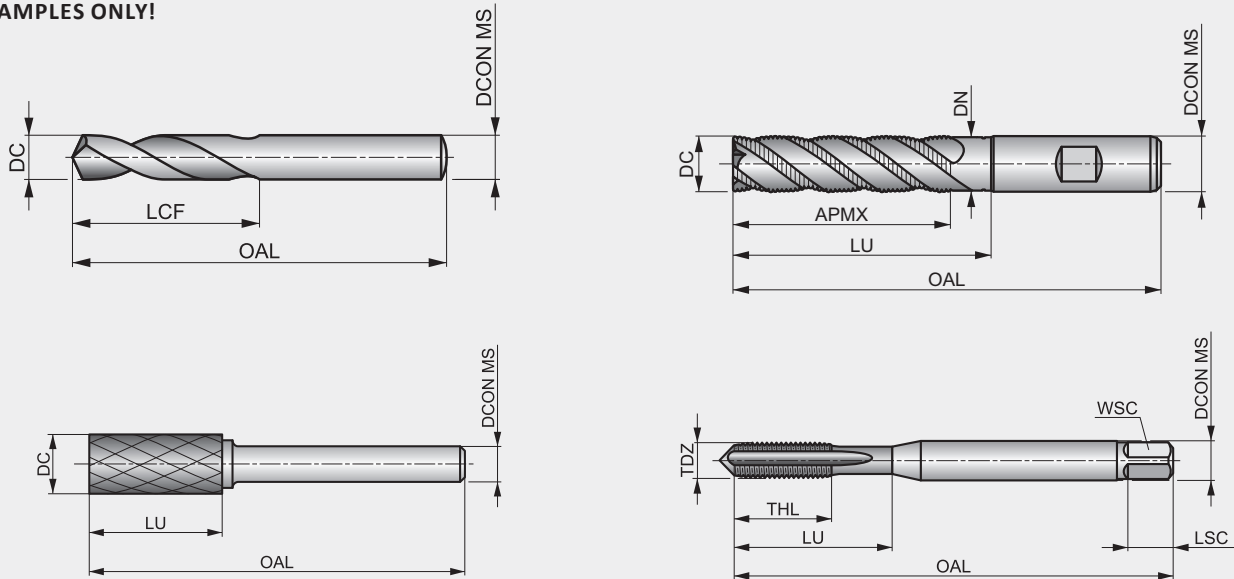

ISO 13399	description
BD	Body diameter
BDX	Body diameter maximum
CZC MS	Connection size code machine side
D1	Fixing hole diameter
DC	Cutting diameter
DCN	Cutting diameter minimum
DCON MS	Connection diameter machine side
DCON WS	Connection diameter workpiece side
DCX	Cutting diameter maximum
DHUB	Hub diameter
FLGT	Flange thickness
IC	Inscribed circle diameter
L	Cutting edge length
LB	Body length
LF	Functional length
LPR	Protruding length
LU	Usable length
OAL	Overall length
RE	Corner radius
S	Insert thickness
WF	Functional width
APMX	Depth of cut maximum
D1	Fixing hole diameter
DC_1	Cutting diameter first cutting step
DC_2	Cutting diameter second cutting step

ISO 13399	description
DF	Flange diameter
DH	Head diameter
GPD	Guide pilot diameter
GPL	Guide pilot length
H	Shank height
HSD	Size of drive part
IC	Inscribed circle diameter
LCF	Length chip flute
LCOL	Collet length
LDC	Distance reference point PK
LH	Head length
LS	Shank length
LSC	Clamping length
NOF	Number of flutes
PLGL	Plug length
RCSK	Radius countersunk
RE	Corner radius
SDI	Step diameter increments
SDL	Step diameter length
SDL_1	Step diameter length first cutting step
SDL_2	Step diameter length second cutting step
TDZ	Thread diameter size
THLGTH	Thread length
WSC	Clamping width

SOLID CARBIDE DRILLS
HSS DRILLS





1 R100



Solid Carbide Jobber Drill, Bright Finish

Improved wear resistance for increased productivity and extended tool life. A 120°, 4-facet point helps with self-centering and reduces cutting forces. Can be used with all CNC machine applications.

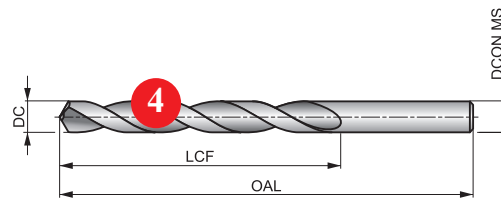

HM	DIN 338	4xD
120°	Bright	
20-35°	R	DC h7

5

6

7

8

Workpiece material group suitability, starting values for cutting speed (m/min) and feed Alpha Code. Tables with feed per revolution can be found starting from page 41.

P1.1	P1.2	P1.3	P2.1	P2.2	P2.3	P3.1	P3.2	P3.3	P4.1	P4.2	P4.3	K1.1	K1.2
99 S	111 S	115 S	85 S	75 S	66 S	66 S	53 S	45 S	40 S	34 S	27 S	75 T	56 T
K1.3	K2.1	K2.2	K2.3	K3.1	K3.2	K3.3	K4.1	K4.2	K4.3	K4.4	K4.5	K5.1	K5.2
42 T	68 T	55 T	44 T	60 T	46 T	37 T	55 T	42 T	31 T	26 T	22 T	63 T	47 T
K5.3	N1.1	N1.2	N1.3	N2.1	N2.2	N2.3	N3.1	N3.2	N4.1	N4.2	H1.1	H2.1	H2.2
37 T	200 V	150 V	100 V	172 V	155 V	112 V	423 V	250 V	60 X	100 V	56 S	33 S	36 S
H3.1	H3.2												
37 S	30 S												

Product	DC	DC	LCF	OAL	DCON MS
	[mm]	[inch]	[mm]	[mm]	[mm]
R1001.0	1.00	0.0394	12.0	34.0	1.00
R1001.1	1.10	0.0433	14.0	36.0	1.10
R1001.2	1.20	0.0472	16.0	38.0	1.20
R1001.3	1.30	0.0512	16.0	38.0	1.30
R1001.4	1.40	0.0551	18.0	40.0	1.40
R1001.5	1.50	0.0591	18.0	40.0	1.50
R1001.6	1.60	0.0630	20.0	43.0	1.60
R1001.7	1.70	0.0669	20.0	43.0	1.70
R1001.8	1.80	0.0709	22.0	46.0	1.80
R1001.9	1.90	0.0748	22.0	46.0	1.90
R1002.0	2.00	0.0787	24.0	49.0	2.00

Product	DC	DC	LCF	OAL	DCON MS
	[mm]	[inch]	[mm]	[mm]	[mm]
R1003.6	3.60	0.1417	39.0	70.0	3.60
R1003.7	3.70	0.1457	39.0	70.0	3.70
R1003.8	3.80	0.1496	43.0	75.0	3.80
R1003.9	3.90	0.1535	43.0	75.0	3.90
R1004.0	4.00	0.1575	43.0	75.0	4.00
R1004.1	4.10	0.1614	43.0	75.0	4.10
R1004.2	4.20	0.1654	43.0	75.0	4.20
R1004.3	4.30	0.1693	47.0	80.0	4.30
R1004.4	4.40	0.1732	47.0	80.0	4.40
R1004.5	4.50	0.1772	47.0	80.0	4.50
R1004.6	4.60	0.1811	47.0	80.0	4.60

Pos.	Description
1	Designation of drill
2	Product description
3	Illustrative picture
4	Schematic drawing of tool



Pos.	Description
5	Product features
6	Material group recommendations incl. speed and feed guidance
7	Product code
8	Product dimensions

SOLID CARBIDE & HSS DRILLS – ICONS OVERVIEW

GENERAL ICONS

	Primary use		Possible use
---	-------------	---	--------------

APPLICATION ANGLE

	Drill Point 118°		Drill Point 135°
	Drill Point 120°		Spot-weld Drill Point 180°

BASIC STANDARD GROUP (BSG)

	BS 328 – Drills and Reamers Standards		DIN 340 – Taper Length Drill Standards		DIN 8037 – Carbide Tipped Drill Standards
	DIN 1870 (1) – Morse Taper Shank Extra Long Drill Standards		DIN 341 – Morse Taper Shank Long Drill Standards		Dormer Standards
	DIN 338 – Straight Shank Drill Standards		DIN 345 – Morse Taper Shank Drill Standards		

COATING

	Bright (uncoated)		Bronze Tempered (Bronze Oxide) Surface Treatment		Titanium Nitride Coating
	Bright and TiN (Tip Coating)		Steam Tempered (Steam Oxide) Surface Treatment		





CUTTING DIRECTION

	Right Hand Rotation / Cutting
---	-------------------------------

CUTTING DIAMETER TOLERANCE ZONE CLASS (TCDC)

	h8 – Industry Standard Tool Tolerance Zone (based on diameter range)		h7 – Industry Standard Tool Tolerance Zone (based on diameter range)
---	--	---	--

MATERIAL CODE (BMC)

	Hard Material (Solid Carbide)		High Speed Steel (tool body) with Solid Carbide (cutting tool material)		High Speed Steel Tool Material
	High Speed Cobalt Steel Tool Material				

SOLID CARBIDE & HSS DRILLS – ICONS OVERVIEW

SHANK



Cylindrical Shank / Straight Shank



Morse Taper Shank



Reduced Cylindrical Shank



Cylindrical Shank with Tang

SPIRAL FORM



Quick Spiral Flute Design



Standard Spiral Flute Design

USABLE LENGTH DIAMETER RATIO (ULDR)



1.25xD Usable Tool Depth to Diameter Ratio



1xD Usable Tool Depth to Diameter Ratio



6xD Usable Tool Depth to Diameter Ratio



1.5xD Usable Tool Depth to Diameter Ratio



2.5xD Usable Tool Depth to Diameter Ratio



10xD Usable Tool Depth to Diameter Ratio



4xD Usable Tool Depth to Diameter Ratio

SOLID CARBIDE – NAVIGATOR TOOL MATERIALS

Carbide materials

**Carbide Materials
(or Hard Materials)**

HM

A sintered powder metallurgy substrate, consisting of a metallic carbide composite with binder metal. The most central raw material is tungsten carbide (WC). Tungsten carbide contributes to the hardness of the material. Tantalum carbide (TaC), titanium carbide (TiC) and niobium carbide (NbC) complements WC and adjusts the properties to what is desired. These three materials are called cubic carbides. Cobalt (Co) acts as a binder and keeps the material together.

Carbide materials are often characterised by high compression strength, high hardness and therefore high wear resistance, but also by limited flexural strength and toughness. Carbide is used in taps, reamers, milling cutters, drills and thread milling cutters.

Surface Coatings



Bright (uncoated)



Bright finish (uncoated surface) improves chip flow in soft or non-ferrous materials, plastics and composites while maintaining sharp cutting edges.

HSS DRILLS – NAVIGATOR TOOL MATERIALS



Tool materials

High Speed Steel		A medium-alloyed high speed steel that has good machinability and good performance. HSS exhibits hardness, toughness and wear resistance characteristics that make it attractive in a wide range of applications, for example in drills and taps.
Cobalt High Speed Steel		This high speed steel contains cobalt for increased hot hardness. The composition of HSCo is a good combination of toughness and hardness. It has good machinability and good wear resistance, which makes it usable for drills, taps, milling cutters and reamers.



Carbide materials

Carbide and High Speed Steel		Combined carbide and high speed steel materials typically joined together with high temperature braze alloy as the interface. This brazed combination of tool materials offers a solid carbide cutting portion which provides high compression strength, hardness and wear resistance attached to a high speed steel body which provides flexural strength and toughness in the tool body.
-------------------------------------	---	--

Surface Treatments

Bright (uncoated)		Bright finish (uncoated surface) improves chip flow in soft or non-ferrous materials, plastics and composites while maintaining sharp cutting edges.
Steam Tempering		Steam tempering gives a strongly adhering blue oxide surface that acts to retain cutting fluid and prevent chip to tool welding, thereby counteracting the formation of a built-up edge. Steam tempering can be applied to any bright tool but is most effective on drills and taps.
Bronze Tempering		Bronze tempering creates a smooth thin bronze oxide layer on the tool surface. Similar to Steam Tempering it helps to prevent chip to tool welding and aids in chip evacuation. Bronze tempering can be applied to any bright tool and can also be applied in combination with Steam Tempering on some tools.

Surface Coatings

Bright and TiN (Tip Coating)		Titanium Nitride is a gold coloured ceramic coating applied by physical vapor deposition (PVD). High hardness combined with low friction properties ensures longer tool life and/or better cutting performance over tools which have not been coated.
Titanium Nitride (TiN)		Titanium Nitride is a gold coloured ceramic coating applied by physical vapor deposition (PVD). High hardness combined with low friction properties ensures longer tool life and/or better cutting performance over tools which have not been coated.



Material code (BMC)	HSS	HSS	HSS	HSS	HSS	HSS	HSS	HSS	HSS-E	HSS-E	HSS HM	HSS HM	HM
Basic standard group (BSG)	DIN 1897	DIN 338	DIN 340	BS 328	DIN ANSI	DIN 338	DIN 338	DIN 338	DIN 1897	DIN 338	DIN 8037	DIN 338	DIN 6539
Usable length (ULDR)	2.5xD	4xD	6xD	10xD	2.5xD	4xD	4xD	4xD	2.5xD	4xD	2.5xD	4xD	2.5xD
Application angle													
Coating													
Shank													
Spiral form													
Hand (Cutting direction)													
Product Family Code	A120 0.50 - 25.00 	A100 0.20 - 20.00 	A110 0.50 - 1" 	A125 1.40 - 1" 	A022 0.50 - 16.00 	A002 1.00 - 16.00 	A002S 2.00 - 13.00 	A108 1.00 - 16.00 	A117 1.00 - 13.00 	A777 0.30 - 16.00 	A124 3.00 - 16.00 	A160 4.00 - 16.00 	R120 1.00 - 12.00
P	P1	■	■	■	■	■	■	■	■	■	■	■	■
	P2	■	■	■	■	■	■	■	■	■	■	■	■
	P3	■	■	■	■	■	■	■	■	■	■	■	■
	P4	■	■	■	■	■	■	■	■	■	■	■	■
M	M1	■	■	■	■	■	■	■	■	■	■	■	■
	M2	■	■	■	■	■	■	■	■	■	■	■	■
	M3	■	■	■	■	■	■	■	■	■	■	■	■
	M4	■	■	■	■	■	■	■	■	■	■	■	■
K	K1	■	■	■	■	■	■	■	■	■	■	■	■
	K2	■	■	■	■	■	■	■	■	■	■	■	■
	K3	■	■	■	■	■	■	■	■	■	■	■	■
	K4	■	■	■	■	■	■	■	■	■	■	■	■
	K5	■	■	■	■	■	■	■	■	■	■	■	■
N	N1	■	■	■	■	■	■	■	■	■	■	■	■
	N2	■	■	■	■	■	■	■	■	■	■	■	■
	N3	■	■	■	■	■	■	■	■	■	■	■	■
	N4	■	■	■	■	■	■	■	■	■	■	■	■
	N5	■	■	■	■	■	■	■	■	■	■	■	■
S	S1	■	■	■	■	■	■	■	■	■	■	■	■
	S2	■	■	■	■	■	■	■	■	■	■	■	■
	S3	■	■	■	■	■	■	■	■	■	■	■	■
	S4	■	■	■	■	■	■	■	■	■	■	■	■
H	H1	■	■	■	■	■	■	■	■	■	■	■	■
	H2	■	■	■	■	■	■	■	■	■	■	■	■
	H3	■	■	■	■	■	■	■	■	■	■	■	■
	H4	■	■	■	■	■	■	■	■	■	■	■	■

■ Primary use ■ Possible use

	HM	HSS	HSS	HSS-E	HSS	HSS	HSS	HSS	HSS	HSS-E	HSS HM		
	DIN 338	DIN 1897	DIN 1897	DORNER	DORNER	DIN 345	DIN 341	DIN 1870(1)	DIN 345	DIN 345	DIN 345		
	4xD	1.5xD	1.25xD	1xD	4xD	4xD	6xD	10xD	4xD	4xD	4xD		
	Bright	ST	ST	Bronze	ST	ST	ST	ST	TN	Bronze	Bright ST		
	λ 20-35°	λ 20-35°	λ 20-35°	λ 20-35°	λ 20-35°	λ 20-35°	λ 20-35°	λ 20-35°	λ 20-35°	λ 20-35°	λ 20-35°		
	R100	A123	A119	A723	A170	A130	A350	A345	A530	A730	A166	M150	M152
	1.00 - 14.00	3/32 - 1/4	3.30 - 5.10	6.00 - 8.00	13.00 - 1.1/2	3.00 - 50.80	5.00 - 50.00	8.00 - 50.00	8.50 - 40.00	10.00 - 32.00	10.00 - 33.00		
	41	43	44	45	46	48	54	56	58	59	61	62	63
P1	<input checked="" type="checkbox"/>	<input type="checkbox"/>	<input type="checkbox"/>	<input type="checkbox"/>	<input type="checkbox"/>	<input type="checkbox"/>	<input type="checkbox"/>	<input type="checkbox"/>	<input type="checkbox"/>	<input checked="" type="checkbox"/>	<input checked="" type="checkbox"/>		
P2	<input checked="" type="checkbox"/>	<input type="checkbox"/>	<input checked="" type="checkbox"/>	<input checked="" type="checkbox"/>	<input type="checkbox"/>	<input type="checkbox"/>	<input checked="" type="checkbox"/>	<input checked="" type="checkbox"/>	<input type="checkbox"/>	<input checked="" type="checkbox"/>	<input checked="" type="checkbox"/>		
P3	<input checked="" type="checkbox"/>	<input checked="" type="checkbox"/>	<input checked="" type="checkbox"/>	<input checked="" type="checkbox"/>	<input checked="" type="checkbox"/>	<input type="checkbox"/>	<input checked="" type="checkbox"/>	<input checked="" type="checkbox"/>	<input type="checkbox"/>	<input checked="" type="checkbox"/>	<input checked="" type="checkbox"/>		
P4	<input checked="" type="checkbox"/>	<input checked="" type="checkbox"/>	<input checked="" type="checkbox"/>	<input checked="" type="checkbox"/>	<input checked="" type="checkbox"/>	<input checked="" type="checkbox"/>	<input checked="" type="checkbox"/>	<input checked="" type="checkbox"/>	<input checked="" type="checkbox"/>	<input type="checkbox"/>	<input checked="" type="checkbox"/>		
M1		<input checked="" type="checkbox"/>	<input checked="" type="checkbox"/>	<input type="checkbox"/>	<input checked="" type="checkbox"/>	<input checked="" type="checkbox"/>	<input checked="" type="checkbox"/>	<input checked="" type="checkbox"/>	<input checked="" type="checkbox"/>	<input checked="" type="checkbox"/>	<input checked="" type="checkbox"/>		
M2		<input checked="" type="checkbox"/>	<input checked="" type="checkbox"/>	<input type="checkbox"/>	<input checked="" type="checkbox"/>	<input checked="" type="checkbox"/>	<input checked="" type="checkbox"/>	<input checked="" type="checkbox"/>	<input checked="" type="checkbox"/>	<input checked="" type="checkbox"/>	<input checked="" type="checkbox"/>		
M3		<input checked="" type="checkbox"/>	<input checked="" type="checkbox"/>	<input type="checkbox"/>	<input checked="" type="checkbox"/>	<input checked="" type="checkbox"/>	<input checked="" type="checkbox"/>	<input checked="" type="checkbox"/>	<input checked="" type="checkbox"/>	<input type="checkbox"/>	<input checked="" type="checkbox"/>		
M4		<input checked="" type="checkbox"/>	<input checked="" type="checkbox"/>	<input type="checkbox"/>	<input checked="" type="checkbox"/>	<input checked="" type="checkbox"/>	<input checked="" type="checkbox"/>	<input checked="" type="checkbox"/>	<input checked="" type="checkbox"/>	<input type="checkbox"/>	<input checked="" type="checkbox"/>		
K1	<input checked="" type="checkbox"/>				<input checked="" type="checkbox"/>	<input type="checkbox"/>	<input checked="" type="checkbox"/>	<input checked="" type="checkbox"/>	<input type="checkbox"/>	<input checked="" type="checkbox"/>	<input type="checkbox"/>		
K2	<input checked="" type="checkbox"/>				<input checked="" type="checkbox"/>	<input checked="" type="checkbox"/>	<input checked="" type="checkbox"/>	<input checked="" type="checkbox"/>	<input type="checkbox"/>	<input checked="" type="checkbox"/>	<input type="checkbox"/>		
K3	<input checked="" type="checkbox"/>				<input checked="" type="checkbox"/>	<input checked="" type="checkbox"/>	<input checked="" type="checkbox"/>	<input checked="" type="checkbox"/>	<input type="checkbox"/>	<input checked="" type="checkbox"/>	<input type="checkbox"/>		
K4	<input checked="" type="checkbox"/>				<input checked="" type="checkbox"/>	<input checked="" type="checkbox"/>	<input checked="" type="checkbox"/>	<input checked="" type="checkbox"/>	<input checked="" type="checkbox"/>	<input type="checkbox"/>	<input type="checkbox"/>		
K5	<input checked="" type="checkbox"/>				<input checked="" type="checkbox"/>	<input checked="" type="checkbox"/>	<input checked="" type="checkbox"/>	<input checked="" type="checkbox"/>	<input type="checkbox"/>	<input checked="" type="checkbox"/>	<input type="checkbox"/>		
N1	<input checked="" type="checkbox"/>	<input type="checkbox"/>	<input checked="" type="checkbox"/>		<input checked="" type="checkbox"/>	<input checked="" type="checkbox"/>	<input checked="" type="checkbox"/>	<input checked="" type="checkbox"/>	<input checked="" type="checkbox"/>	<input checked="" type="checkbox"/>	<input checked="" type="checkbox"/>		
N2	<input checked="" type="checkbox"/>	<input checked="" type="checkbox"/>	<input checked="" type="checkbox"/>		<input checked="" type="checkbox"/>	<input checked="" type="checkbox"/>	<input checked="" type="checkbox"/>	<input checked="" type="checkbox"/>	<input checked="" type="checkbox"/>	<input checked="" type="checkbox"/>	<input checked="" type="checkbox"/>		
N3	<input type="checkbox"/>	<input type="checkbox"/>	<input checked="" type="checkbox"/>		<input checked="" type="checkbox"/>	<input checked="" type="checkbox"/>	<input checked="" type="checkbox"/>	<input checked="" type="checkbox"/>	<input checked="" type="checkbox"/>	<input checked="" type="checkbox"/>	<input checked="" type="checkbox"/>		
N4	<input type="checkbox"/>	<input checked="" type="checkbox"/>	<input checked="" type="checkbox"/>		<input checked="" type="checkbox"/>	<input checked="" type="checkbox"/>	<input checked="" type="checkbox"/>	<input checked="" type="checkbox"/>	<input checked="" type="checkbox"/>	<input checked="" type="checkbox"/>	<input checked="" type="checkbox"/>		
N5													
S1		<input checked="" type="checkbox"/>	<input checked="" type="checkbox"/>		<input checked="" type="checkbox"/>	<input checked="" type="checkbox"/>	<input checked="" type="checkbox"/>	<input checked="" type="checkbox"/>	<input checked="" type="checkbox"/>	<input checked="" type="checkbox"/>	<input checked="" type="checkbox"/>		
S2		<input checked="" type="checkbox"/>	<input checked="" type="checkbox"/>		<input checked="" type="checkbox"/>	<input checked="" type="checkbox"/>	<input checked="" type="checkbox"/>	<input checked="" type="checkbox"/>	<input checked="" type="checkbox"/>	<input checked="" type="checkbox"/>	<input checked="" type="checkbox"/>		
S3		<input checked="" type="checkbox"/>	<input checked="" type="checkbox"/>		<input checked="" type="checkbox"/>	<input checked="" type="checkbox"/>	<input checked="" type="checkbox"/>	<input checked="" type="checkbox"/>	<input checked="" type="checkbox"/>	<input checked="" type="checkbox"/>	<input checked="" type="checkbox"/>		
S4		<input checked="" type="checkbox"/>	<input checked="" type="checkbox"/>		<input checked="" type="checkbox"/>	<input checked="" type="checkbox"/>	<input checked="" type="checkbox"/>	<input checked="" type="checkbox"/>	<input checked="" type="checkbox"/>	<input checked="" type="checkbox"/>	<input checked="" type="checkbox"/>		
H1	<input checked="" type="checkbox"/>												
H2	<input checked="" type="checkbox"/>												
H3	<input checked="" type="checkbox"/>												
H4													

Material code (BMC)	HSS	HSS	HSS	HSS	HSS	HSS
Basic standard group (BSG)	DIN ANSI	DIN 338	DIN 338	DIN 338	DIN 338	DIN 338
Usable length (ULDR)	2.5×D	4×D	4×D	4×D	4×D	4×D
Application angle						
Coating						
Shank						
Spiral form						
Hand (Cutting direction)						
Product Family Code	A088	A095	A087	A094	A089	A190
	Set	Set	Set	Set	Set	Set
	64	65	66	66	67	68
P	P1					
	P2					
	P3					
	P4					
M	M1					
	M2					
	M3					
	M4					
K	K1					
	K2					
	K3					
	K4					
	K5					
N	N1					
	N2					
	N3					
	N4					
	N5					
S	S1					
	S2					
	S3					
	S4					
H	H1					
	H2					
	H3					
	H4					

A120



HSS Stub Drill, Steam Tempered Finish

Versatile drill with Steam tempered finish. A 135° split point reduces the forces when drilling and prevents the drill from wandering over the surface of the material. Steam tempered finish retains cutting fluid and prevents chip to tool welding. Suitable for hand-held and machine drilling of many materials.

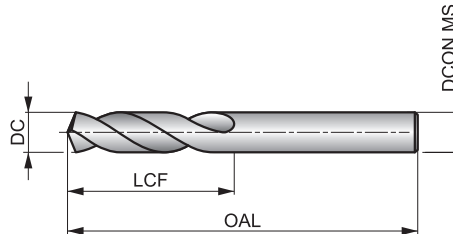

HSS	DIN 1897	2.5×D
135°	ST	
λ 20-35°	R	DC h8

Workpiece material group suitability, starting values for cutting speed (m/min) and feed Alpha Code. Tables with feed per revolution can be found starting from page 71.

P1.1 ■ 36 J	P1.2 ■ 40 J	P1.3 ■ 41 J	P2.1 ■ 31 J	P2.2 ■ 27 G	P2.3 ■ 24 F	P3.1 ■ 21 G	P3.2 ■ 17 G	P3.3 ■ 14 F	P4.1 ■ 12 G	P4.2 ■ 10 F	P4.3 ■ 9 E	M1.1 ■ 22 F	M1.2 ■ 19 F
M2.1 ■ 20 F	M2.2 ■ 16 F	M3.1 ■ 10 H	M3.2 ■ 9 H	M3.3 ■ 8 H	M4.1 ■ 10 D	K1.1 ■ 32 J	K1.2 ■ 24 G	K1.3 ■ 18 G	K2.1 ■ 25 F	K2.2 ■ 20 F	K2.3 ■ 16 F	K3.1 ■ 22 F	K3.2 ■ 17 F
K3.3 ■ 13 F	K4.1 ■ 20 F	K4.2 ■ 15 F	K4.3 ■ 11 F	K4.4 ■ 10 F	K4.5 ■ 8 F	K5.1 ■ 23 F	K5.2 ■ 17 F	K5.3 ■ 13 F	N1.1 ■ 33 K	N1.2 ■ 25 K	N1.3 ■ 17 J	N2.1 ■ 46 I	N2.2 ■ 42 I
N2.3 ■ 30 I	N3.1 ■ 64 I	N3.2 ■ 38 J	N3.3 ■ 19 H	N4.1 ■ 30 K	N4.2 ■ 35 I	N4.3 ■ 17 G	S1.1 ■ 27 G	S1.2 ■ 16 E	S1.3 ■ 8 C	S2.1 ■ 11 F	S2.2 ■ 6 B	S3.1 ■ 8 F	S3.2 ■ 4 B
S4.1 ■ 6 F	S4.2 ■ 3 B												

DC <= 1mm Bright; 2.9mm => DC >= 13.0mm 118° Point.

Product	DC (inch)	DC (mm)	DC (inch)	LCF (mm)	OAL (mm)	DCON MS (mm)
A120.5	–	0.50	0.0197	3.0	20.0	0.50
A120.6	–	0.60	0.0236	3.5	21.0	0.60
A120.7	–	0.70	0.0276	4.5	23.0	0.70
A1201/32	1/32	0.79	0.0313	5.0	24.0	0.79
A120.8	–	0.80	0.0315	5.0	24.0	0.80
A120.9	–	0.90	0.0354	5.5	25.0	0.90
A1201.0	–	1.00	0.0394	6.0	26.0	1.00
A1201.1	–	1.10	0.0433	7.0	28.0	1.10
A1203/64	3/64	1.19	0.0469	8.0	30.0	1.19
A1201.2	–	1.20	0.0472	8.0	30.0	1.20
A1201.3	–	1.30	0.0512	8.0	30.0	1.30
A1201.4	–	1.40	0.0551	9.0	32.0	1.40
A1201.5	–	1.50	0.0591	9.0	32.0	1.50
A1201/16	1/16	1.59	0.0625	10.0	34.0	1.59
A1201.6	–	1.60	0.0630	10.0	34.0	1.60
A1201.7	–	1.70	0.0669	10.0	34.0	1.70
A1201.8	–	1.80	0.0709	11.0	36.0	1.80
A1201.9	–	1.90	0.0748	11.0	36.0	1.90
A1205/64	5/64	1.98	0.0781	12.0	38.0	1.98
A1202.0	–	2.00	0.0787	12.0	38.0	2.00
A1202.1	–	2.10	0.0827	12.0	38.0	2.10
A1202.2	–	2.20	0.0866	13.0	40.0	2.20
A1202.25	–	2.25	0.0886	13.0	40.0	2.25

Product	DC (inch)	DC (mm)	DC (inch)	LCF (mm)	OAL (mm)	DCON MS (mm)
A1202.3	–	2.30	0.0906	13.0	40.0	2.30
A1203/32	3/32	2.38	0.0938	14.0	43.0	2.38
A1202.4	–	2.40	0.0945	14.0	43.0	2.40
A1202.5	–	2.50	0.0984	14.0	43.0	2.50
A1202.6	–	2.60	0.1024	14.0	43.0	2.60
A1202.65	–	2.65	0.1043	14.0	43.0	2.65
A1202.7	–	2.70	0.1063	16.0	46.0	2.70
A1207/64	7/64	2.78	0.1094	16.0	46.0	2.78
A1202.8	–	2.80	0.1102	16.0	46.0	2.80
A1202.9	–	2.90	0.1142	16.0	46.0	2.90
A1203.0	–	3.00	0.1181	16.0	46.0	3.00
A1203.1	–	3.10	0.1220	18.0	49.0	3.10
A1201/8	1/8	3.18	0.1252	18.0	49.0	3.18
A1203.2	–	3.20	0.1260	18.0	49.0	3.20
A1203.25	–	3.25	0.1280	18.0	49.0	3.25
A1203.3	–	3.30	0.1299	18.0	49.0	3.30
A1203.4	–	3.40	0.1339	20.0	52.0	3.40
A1203.5	–	3.50	0.1378	20.0	52.0	3.50
A1209/64	9/64	3.57	0.1406	20.0	52.0	3.57
A1203.6	–	3.60	0.1417	20.0	52.0	3.60
A1203.7	–	3.70	0.1457	20.0	52.0	3.70
A1203.8	–	3.80	0.1496	22.0	55.0	3.80
A1203.9	–	3.90	0.1535	22.0	55.0	3.90



Product	DC	DC	DC	LCF	OAL	D CON MS
	(inch)	(mm)	(inch)	(mm)	(mm)	(mm)
A1205/32	5/32	3.97	0.1563	22.0	55.0	3.97
A1204.0	–	4.00	0.1575	22.0	55.0	4.00
A1204.1	–	4.10	0.1614	22.0	55.0	4.10
A1204.2	–	4.20	0.1654	22.0	55.0	4.20
A1204.3	–	4.30	0.1693	24.0	58.0	4.30
A12011/64	11/64	4.37	0.1719	24.0	58.0	4.37
A1204.4	–	4.40	0.1732	24.0	58.0	4.40
A1204.5	–	4.50	0.1772	24.0	58.0	4.50
A1204.6	–	4.60	0.1811	24.0	58.0	4.60
A1204.7	–	4.70	0.1850	24.0	58.0	4.70
A1203/16	3/16	4.76	0.1875	26.0	62.0	4.76
A1204.8	–	4.80	0.1890	26.0	62.0	4.80
A1204.9	–	4.90	0.1929	26.0	62.0	4.90
A1205.0	–	5.00	0.1969	26.0	62.0	5.00
A1205.1	–	5.10	0.2008	26.0	62.0	5.10
A12013/64	13/64	5.16	0.2031	26.0	62.0	5.16
A1205.2	–	5.20	0.2047	26.0	62.0	5.20
A1205.3	–	5.30	0.2087	26.0	62.0	5.30
A1205.4	–	5.40	0.2126	28.0	66.0	5.40
A1205.5	–	5.50	0.2165	28.0	66.0	5.50
A1207/32	7/32	5.56	0.2188	28.0	66.0	5.56
A1205.6	–	5.60	0.2205	28.0	66.0	5.60
A1205.7	–	5.70	0.2244	28.0	66.0	5.70
A1205.8	–	5.80	0.2283	28.0	66.0	5.80
A1205.9	–	5.90	0.2323	28.0	66.0	5.90
A12015/64	15/64	5.95	0.2344	28.0	66.0	5.95
A1206.0	–	6.00	0.2362	28.0	66.0	6.00
A1206.1	–	6.10	0.2402	31.0	70.0	6.10
A1206.2	–	6.20	0.2441	31.0	70.0	6.20
A1206.3	–	6.30	0.2480	31.0	70.0	6.30
A1201/4	1/4	6.35	0.2500	31.0	70.0	6.35
A1206.4	–	6.40	0.2520	31.0	70.0	6.40
A1206.5	–	6.50	0.2559	31.0	70.0	6.50
A1206.6	–	6.60	0.2598	31.0	70.0	6.60
A1206.7	–	6.70	0.2638	31.0	70.0	6.70
A1206.8	–	6.80	0.2677	34.0	74.0	6.80
A1206.9	–	6.90	0.2717	34.0	74.0	6.90
A1207.0	–	7.00	0.2756	34.0	74.0	7.00
A1207.1	–	7.10	0.2795	34.0	74.0	7.10
A1209/32	9/32	7.14	0.2813	34.0	74.0	7.14
A1207.2	–	7.20	0.2835	34.0	74.0	7.20
A1207.3	–	7.30	0.2874	34.0	74.0	7.30
A1207.4	–	7.40	0.2913	34.0	74.0	7.40
A1207.5	–	7.50	0.2953	34.0	74.0	7.50
A1207.6	–	7.60	0.2992	37.0	79.0	7.60
A1207.7	–	7.70	0.3031	37.0	79.0	7.70
A1207.8	–	7.80	0.3071	37.0	79.0	7.80
A1207.9	–	7.90	0.3110	37.0	79.0	7.90
A1205/16	5/16	7.94	0.3125	37.0	79.0	7.94
A1208.0	–	8.00	0.3150	37.0	79.0	8.00
A1208.1	–	8.10	0.3189	37.0	79.0	8.10
A1208.2	–	8.20	0.3228	37.0	79.0	8.20
A1208.3	–	8.30	0.3268	37.0	79.0	8.30
A1208.4	–	8.40	0.3307	37.0	79.0	8.40
A1208.5	–	8.50	0.3346	37.0	79.0	8.50
A1208.6	–	8.60	0.3386	40.0	84.0	8.60
A1208.7	–	8.70	0.3425	40.0	84.0	8.70
A12011/32	11/32	8.73	0.3438	40.0	84.0	8.73
A1208.8	–	8.80	0.3465	40.0	84.0	8.80
A1208.9	–	8.90	0.3504	40.0	84.0	8.90
A1209.0	–	9.00	0.3543	40.0	84.0	9.00
A1209.1	–	9.10	0.3583	40.0	84.0	9.10
A1209.2	–	9.20	0.3622	40.0	84.0	9.20
A1209.3	–	9.30	0.3661	40.0	84.0	9.30
A1209.4	–	9.40	0.3701	40.0	84.0	9.40

Product	DC	DC	DC	LCF	OAL	D CON MS
	(inch)	(mm)	(inch)	(mm)	(mm)	(mm)
A1209.5	–	9.50	0.3740	40.0	84.0	9.50
A1203/8	3/8	9.52	0.3750	43.0	89.0	9.52
A1209.6	–	9.60	0.3780	43.0	89.0	9.60
A1209.7	–	9.70	0.3819	43.0	89.0	9.70
A1209.8	–	9.80	0.3858	43.0	89.0	9.80
A1209.9	–	9.90	0.3898	43.0	89.0	9.90
A12010.0	–	10.00	0.3937	43.0	89.0	10.00
A12010.1	–	10.10	0.3976	43.0	89.0	10.10
A12010.2	–	10.20	0.4016	43.0	89.0	10.20
A12010.3	–	10.30	0.4055	43.0	89.0	10.30
A12013/32	13/32	10.32	0.4063	43.0	89.0	10.32
A12010.4	–	10.40	0.4094	43.0	89.0	10.40
A12010.5	–	10.50	0.4134	43.0	89.0	10.50
A12010.6	–	10.60	0.4173	43.0	89.0	10.60
A12010.7	–	10.70	0.4213	47.0	95.0	10.70
A12010.8	–	10.80	0.4252	47.0	95.0	10.80
A12010.9	–	10.90	0.4291	47.0	95.0	10.90
A12011.0	–	11.00	0.4331	47.0	95.0	11.00
A12011.1	–	11.10	0.4370	47.0	95.0	11.10
A1207/16	7/16	11.11	0.4375	47.0	95.0	11.11
A12011.2	–	11.20	0.4409	47.0	95.0	11.20
A12011.3	–	11.30	0.4449	47.0	95.0	11.30
A12011.5	–	11.50	0.4528	47.0	95.0	11.50
A12011.6	–	11.60	0.4567	47.0	95.0	11.60
A12011.7	–	11.70	0.4606	47.0	95.0	11.70
A12011.8	–	11.80	0.4646	47.0	95.0	11.80
A12011.9	–	11.90	0.4685	51.0	102.0	11.90
A12012.0	–	12.00	0.4724	51.0	102.0	12.00
A12012.1	–	12.10	0.4764	51.0	102.0	12.10
A12012.2	–	12.20	0.4803	51.0	102.0	12.20
A12012.5	–	12.50	0.4921	51.0	102.0	12.50
A1201/2	1/2	12.70	0.5000	51.0	102.0	12.70
A12013.0	–	13.00	0.5118	51.0	102.0	13.00
A12013.5	–	13.50	0.5315	54.0	107.0	13.50
A12014.0	–	14.00	0.5512	54.0	107.0	14.00
A1209/16	9/16	14.29	0.5625	56.0	111.0	14.29
A12014.5	–	14.50	0.5709	56.0	111.0	14.50
A12015.0	–	15.00	0.5906	56.0	111.0	15.00
A12015.5	–	15.50	0.6102	58.0	115.0	15.50
A1205/8	5/8	15.88	0.6250	58.0	115.0	15.88
A12016.0	–	16.00	0.6299	58.0	115.0	16.00
A12016.5	–	16.50	0.6496	60.0	119.0	16.50
A12017.0	–	17.00	0.6693	60.0	119.0	17.00
A12011/16	11/16	17.46	0.6875	62.0	123.0	17.46
A12017.5	–	17.50	0.6890	62.0	123.0	17.50
A12018.0	–	18.00	0.7087	62.0	123.0	18.00
A12018.5	–	18.50	0.7283	64.0	127.0	18.50
A12019.0	–	19.00	0.7480	64.0	127.0	19.00
A1203/4	3/4	19.05	0.7500	66.0	131.0	19.05
A12019.5	–	19.50	0.7677	66.0	131.0	19.50
A12020.0	–	20.00	0.7874	66.0	131.0	20.00
A12020.5	–	20.50	0.8071	68.0	136.0	20.50
A12013/16	13/16	20.64	0.8125	68.0	136.0	20.64
A12021.0	–	21.00	0.8268	68.0	136.0	21.00
A12022.0	–	22.00	0.8661	70.0	141.0	22.00
A1207/8	7/8	22.22	0.8750	70.0	141.0	22.22
A12023.0	–	23.00	0.9055	72.0	146.0	23.00
A12015/16	15/16	23.81	0.9375	75.0	151.0	23.81
A12024.0	–	24.00	0.9449	75.0	151.0	24.00
A12025.0	–	25.00	0.9843	75.0	151.0	25.00

A100



HSS Jobber Drill, Steam Tempered Finish

A great and versatile all-around drill with a 118° conventional point, which provides strength and is easy to regrind, making it very cost-effective. Usable for hand-held and machine drilling. Steam tempered finish retains cutting fluid and prevents chip tool welding. Suitable for many materials.

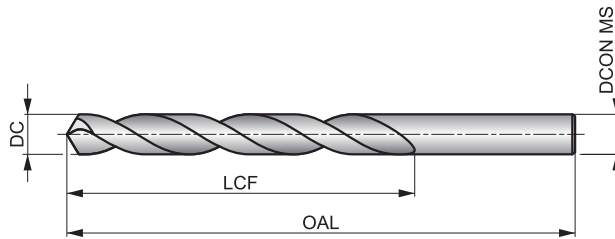

HSS	DIN 338	4xD
118°	ST	
λ 20-35°	R	DC h8

Workpiece material group suitability, starting values for cutting speed (m/min) and feed Alpha Code. Tables with feed per revolution can be found starting from page 71.

P1.1 ■ 33 H	P1.2 ■ 37 H	P1.3 ■ 38 H	P2.1 ■ 28 H	P2.2 ■ 25 F	P2.3 ■ 22 E	P3.1 ■ 19 F	P3.2 ■ 15 F	P3.3 ■ 13 E	P4.1 ■ 11 F	P4.2 ■ 10 E	P4.3 ■ 8 D	M1.1 ■ 21 E	M1.2 ■ 17 E
M2.1 ■ 18 E	M2.2 ■ 15 E	M3.1 ■ 9 G	M3.2 ■ 8 G	M3.3 ■ 7 G	M4.1 ■ 9 C	K1.1 ■ 30 H	K1.2 ■ 22 F	K1.3 ■ 17 F	K2.1 ■ 25 E	K2.2 ■ 20 E	K2.3 ■ 16 E	K3.1 ■ 22 E	K3.2 ■ 17 E
K3.3 ■ 13 E	K4.1 ■ 20 E	K4.2 ■ 15 E	K4.3 ■ 11 E	K4.4 ■ 10 E	K4.5 ■ 8 E	K5.1 ■ 23 E	K5.2 ■ 17 E	K5.3 ■ 13 E	N1.1 ■ 33 J	N1.2 ■ 25 J	N1.3 ■ 17 I	N2.1 ■ 42 H	N2.2 ■ 37 H
N2.3 ■ 27 H	N3.1 ■ 59 H	N3.2 ■ 35 I	N3.3 ■ 18 G	N4.1 ■ 30 J	N4.2 ■ 28 H	N4.3 ■ 14 F	S1.1 ■ 23 E	S1.2 ■ 12 D	S1.3 ■ 6 B	S2.1 ■ 8 E	S2.2 ■ 4 A	S3.1 ■ 6 E	S3.2 ■ 3 A
S4.1 ■ 5 E	S4.2 ■ 2 A												

DC <= 1mm; 3/64"; N60. Bright.

Products from this series are also available in set. Please see A190, A191 or A199.

Product	DC (inch)	DC (mm)	DC (inch)	LCF (mm)	OAL (mm)	DCON MS (mm)
A100.2	-	0.20	0.0079	2.5	19.0	0.20
A100.25	-	0.25	0.0098	3.0	19.0	0.25
A100.3	-	0.30	0.0118	3.0	19.0	0.30
A100.32	-	0.32	0.0126	4.0	19.0	0.32
A100N80	N80	0.34	0.0135	4.0	19.0	0.34
A100.35	-	0.35	0.0138	4.0	19.0	0.35
A100N79	N79	0.37	0.0145	4.0	19.0	0.37
A100.38	-	0.38	0.0150	4.0	19.0	0.38
A1001/64	1/64	0.40	0.0156	5.0	20.0	0.40
A100.4	-	0.40	0.0157	5.0	20.0	0.40
A100N78	N78	0.41	0.0160	5.0	20.0	0.41
A100.42	-	0.42	0.0165	5.0	20.0	0.42
A100.45	-	0.45	0.0177	5.0	20.0	0.45
A100N77	N77	0.46	0.0180	5.0	20.0	0.46
A100.48	-	0.48	0.0189	5.0	20.0	0.48
A100.5	-	0.50	0.0197	6.0	22.0	0.50
A100N76	N76	0.51	0.0200	6.0	22.0	0.51
A100.52	-	0.52	0.0205	6.0	22.0	0.52
A100N75	N75	0.53	0.0210	6.0	22.0	0.53
A100.55	-	0.55	0.0217	7.0	24.0	0.55
A100N74	N74	0.57	0.0225	7.0	24.0	0.57
A100.58	-	0.58	0.0228	7.0	24.0	0.58

Product	DC (inch)	DC (mm)	DC (inch)	LCF (mm)	OAL (mm)	DCON MS (mm)
A100.6	-	0.60	0.0236	7.0	24.0	0.60
A100N73	N73	0.61	0.0240	8.0	26.0	0.61
A100.62	-	0.62	0.0244	8.0	26.0	0.62
A100N72	N72	0.64	0.0250	8.0	26.0	0.64
A100.65	-	0.65	0.0256	8.0	26.0	0.65
A100N71	N71	0.66	0.0260	8.0	26.0	0.66
A100.68	-	0.68	0.0268	9.0	28.0	0.68
A100.7	-	0.70	0.0276	9.0	28.0	0.70
A100N70	N70	0.71	0.0280	9.0	28.0	0.71
A100.72	-	0.72	0.0283	9.0	28.0	0.72
A100N69	N69	0.74	0.0292	9.0	28.0	0.74
A100.75	-	0.75	0.0295	9.0	28.0	0.75
A100.78	-	0.78	0.0307	10.0	30.0	0.78
A1001/32	1/32	0.79	0.0313	10.0	30.0	0.79
A100N68	N68	0.79	0.0310	10.0	30.0	0.79
A100.8	-	0.80	0.0315	10.0	30.0	0.80
A100N67	N67	0.81	0.0320	10.0	30.0	0.81
A100.82	-	0.82	0.0323	10.0	30.0	0.82
A100N66	N66	0.84	0.0330	10.0	30.0	0.84
A100.85	-	0.85	0.0335	10.0	30.0	0.85
A100.88	-	0.88	0.0346	11.0	32.0	0.88
A100N65	N65	0.89	0.0350	11.0	32.0	0.89



Product	DC	DC	DC	LCF	OAL	DCON MS
	(inch)	(mm)	(inch)	(mm)	(mm)	(mm)
A100.9	–	0.90	0.0354	11.0	32.0	0.90
A100N64	N64	0.91	0.0360	11.0	32.0	0.91
A100.92	–	0.92	0.0362	11.0	32.0	0.92
A100N63	N63	0.94	0.0370	11.0	32.0	0.94
A100.95	–	0.95	0.0374	11.0	32.0	0.95
A100N62	N62	0.97	0.0380	12.0	34.0	0.97
A100.98	–	0.98	0.0386	12.0	34.0	0.98
A100N61	N61	0.99	0.0390	12.0	34.0	0.99
A1001.0	–	1.00	0.0394	12.0	34.0	1.00
A100N60	N60	1.02	0.0400	12.0	34.0	1.02
A100N59	N59	1.04	0.0410	12.0	34.0	1.04
A1001.05	–	1.05	0.0413	12.0	34.0	1.05
A100N58	N58	1.07	0.0420	14.0	36.0	1.07
A100N57	N57	1.09	0.0430	14.0	36.0	1.09
A1001.1	–	1.10	0.0433	14.0	36.0	1.10
A1001.15	–	1.15	0.0453	14.0	36.0	1.15
A100N56	N56	1.18	0.0465	14.0	36.0	1.18
A1003/64	3/64	1.19	0.0469	16.0	38.0	1.19
A1001.2	–	1.20	0.0472	16.0	38.0	1.20
A1001.25	–	1.25	0.0492	16.0	38.0	1.25
A1001.3	–	1.30	0.0512	16.0	38.0	1.30
A100N55	N55	1.32	0.0520	16.0	38.0	1.32
A1001.35	–	1.35	0.0531	18.0	40.0	1.35
A1001.4	–	1.40	0.0551	18.0	40.0	1.40
A100N54	N54	1.40	0.0550	18.0	40.0	1.40
A1001.45	–	1.45	0.0571	18.0	40.0	1.45
A1001.5	–	1.50	0.0591	18.0	40.0	1.50
A100N53	N53	1.51	0.0595	20.0	43.0	1.51
A1001.55	–	1.55	0.0610	20.0	43.0	1.55
A1001/16	1/16	1.59	0.0625	20.0	43.0	1.59
A1001.6	–	1.60	0.0630	20.0	43.0	1.60
A100N52	N52	1.61	0.0635	20.0	43.0	1.61
A1001.65	–	1.65	0.0650	20.0	43.0	1.65
A1001.7	–	1.70	0.0669	20.0	43.0	1.70
A100N51	N51	1.70	0.0670	22.0	46.0	1.70
A1001.75	–	1.75	0.0689	22.0	46.0	1.75
A100N50	N50	1.78	0.0700	22.0	46.0	1.78
A1001.8	–	1.80	0.0709	22.0	46.0	1.80
A1001.85	–	1.85	0.0728	22.0	46.0	1.85
A100N49	N49	1.85	0.0730	22.0	46.0	1.85
A1001.9	–	1.90	0.0748	22.0	46.0	1.90
A100N48	N48	1.93	0.0760	24.0	49.0	1.93
A1001.95	–	1.95	0.0768	24.0	49.0	1.95
A1005/64	5/64	1.98	0.0781	24.0	49.0	1.98
A100N47	N47	1.99	0.0785	24.0	49.0	1.99
A1002.0	–	2.00	0.0787	24.0	49.0	2.00
A1002.05	–	2.05	0.0807	24.0	49.0	2.05
A100N46	N46	2.06	0.0810	24.0	49.0	2.06
A100N45	N45	2.08	0.0820	24.0	49.0	2.08
A1002.1	–	2.10	0.0827	24.0	49.0	2.10
A1002.15	–	2.15	0.0846	27.0	53.0	2.15
A100N44	N44	2.18	0.0860	27.0	53.0	2.18
A1002.2	–	2.20	0.0866	27.0	53.0	2.20
A1002.25	–	2.25	0.0886	27.0	53.0	2.25
A100N43	N43	2.26	0.0890	27.0	53.0	2.26
A1002.3	–	2.30	0.0906	27.0	53.0	2.30
A1002.35	–	2.35	0.0925	27.0	53.0	2.35
A1003/32	3/32	2.38	0.0938	30.0	57.0	2.38
A100N42	N42	2.38	0.0935	30.0	57.0	2.38
A1002.4	–	2.40	0.0945	30.0	57.0	2.40
A100N41	N41	2.44	0.0960	30.0	57.0	2.44
A1002.45	–	2.45	0.0965	30.0	57.0	2.45

Product	DC	DC	DC	LCF	OAL	DCON MS
	(inch)	(mm)	(inch)	(mm)	(mm)	(mm)
A100N40	N40	2.49	0.0980	30.0	57.0	2.49
A1002.5	–	2.50	0.0984	30.0	57.0	2.50
A100N39	N39	2.53	0.0995	30.0	57.0	2.53
A1002.55	–	2.55	0.1004	30.0	57.0	2.55
A100N38	N38	2.58	0.1015	30.0	57.0	2.58
A1002.6	–	2.60	0.1024	30.0	57.0	2.60
A100N37	N37	2.64	0.1040	30.0	57.0	2.64
A1002.65	–	2.65	0.1043	30.0	57.0	2.65
A1002.7	–	2.70	0.1063	33.0	61.0	2.70
A100N36	N36	2.71	0.1065	33.0	61.0	2.71
A1002.75	–	2.75	0.1083	33.0	61.0	2.75
A1007/64	7/64	2.78	0.1094	33.0	61.0	2.78
A100N35	N35	2.79	0.1100	33.0	61.0	2.79
A1002.8	–	2.80	0.1102	33.0	61.0	2.80
A100N34	N34	2.82	0.1110	33.0	61.0	2.82
A1002.85	–	2.85	0.1122	33.0	61.0	2.85
A100N33	N33	2.87	0.1130	33.0	61.0	2.87
A1002.9	–	2.90	0.1142	33.0	61.0	2.90
A1002.95	–	2.95	0.1161	33.0	61.0	2.95
A100N32	N32	2.95	0.1160	33.0	61.0	2.95
A1003.0	–	3.00	0.1181	33.0	61.0	3.00
A100N31	N31	3.05	0.1200	36.0	65.0	3.05
A1003.1	–	3.10	0.1220	36.0	65.0	3.10
A1003.15	–	3.15	0.1240	36.0	65.0	3.15
A1001/8	1/8	3.18	0.1250	36.0	65.0	3.18
A1003.2	–	3.20	0.1260	36.0	65.0	3.20
A1003.25	–	3.25	0.1280	36.0	65.0	3.25
A100N30	N30	3.26	0.1285	36.0	65.0	3.26
A1003.3	–	3.30	0.1299	36.0	65.0	3.30
A1003.4	–	3.40	0.1339	39.0	70.0	3.40
A100N29	N29	3.45	0.1360	39.0	70.0	3.45
A1003.5	–	3.50	0.1378	39.0	70.0	3.50
A1009/64	9/64	3.57	0.1406	39.0	70.0	3.57
A100N28	N28	3.57	0.1405	39.0	70.0	3.57
A1003.6	–	3.60	0.1417	39.0	70.0	3.60
A100N27	N27	3.66	0.1440	39.0	70.0	3.66
A1003.7	–	3.70	0.1457	39.0	70.0	3.70
A100N26	N26	3.73	0.1470	39.0	70.0	3.73
A1003.75	–	3.75	0.1476	39.0	70.0	3.75
A1003.8	–	3.80	0.1496	43.0	75.0	3.80
A100N25	N25	3.80	0.1495	43.0	75.0	3.80
A100N24	N24	3.86	0.1520	43.0	75.0	3.86
A1003.9	–	3.90	0.1535	43.0	75.0	3.90
A100N23	N23	3.91	0.1540	43.0	75.0	3.91
A1005/32	5/32	3.97	0.1563	43.0	75.0	3.97
A100N22	N22	3.99	0.1570	43.0	75.0	3.99
A1004.0	–	4.00	0.1575	43.0	75.0	4.00
A100N21	N21	4.04	0.1590	43.0	75.0	4.04
A100N20	N20	4.09	0.1610	43.0	75.0	4.09
A1004.1	–	4.10	0.1614	43.0	75.0	4.10
A1004.2	–	4.20	0.1654	43.0	75.0	4.20
A100N19	N19	4.22	0.1660	43.0	75.0	4.22
A1004.25	–	4.25	0.1673	43.0	75.0	4.25
A1004.3	–	4.30	0.1693	47.0	80.0	4.30
A100N18	N18	4.31	0.1695	47.0	80.0	4.31
A10011/64	11/64	4.37	0.1719	47.0	80.0	4.37
A100N17	N17	4.39	0.1730	47.0	80.0	4.39
A1004.4	–	4.40	0.1732	47.0	80.0	4.40
A1004.5	–	4.50	0.1772	47.0	80.0	4.50
A100N16	N16	4.50	0.1770	47.0	80.0	4.50
A100N15	N15	4.57	0.1800	47.0	80.0	4.57
A1004.6	–	4.60	0.1811	47.0	80.0	4.60



Product	DC	DC	DC	LCF	OAL	D CON MS
	(inch)	(mm)	(inch)	(mm)	(mm)	(mm)
A100N14	N14	4.62	0.1820	47.0	80.0	4.62
A1004.7	–	4.70	0.1850	47.0	80.0	4.70
A100N13	N13	4.70	0.1850	47.0	80.0	4.70
A1004.75	–	4.75	0.1870	47.0	80.0	4.75
A1003/16	3/16	4.76	0.1875	52.0	86.0	4.76
A1004.8	–	4.80	0.1890	52.0	86.0	4.80
A100N12	N12	4.80	0.1890	52.0	86.0	4.80
A100N11	N11	4.85	0.1910	52.0	86.0	4.85
A1004.9	–	4.90	0.1929	52.0	86.0	4.90
A100N10	N10	4.92	0.1935	52.0	86.0	4.92
A100N9	N9	4.98	0.1960	52.0	86.0	4.98
A1005.0	–	5.00	0.1969	52.0	86.0	5.00
A100N8	N8	5.06	0.1990	52.0	86.0	5.06
A1005.1	–	5.10	0.2008	52.0	86.0	5.10
A100N7	N7	5.11	0.2010	52.0	86.0	5.11
A10013/64	13/64	5.16	0.2031	52.0	86.0	5.16
A100N6	N6	5.18	0.2040	52.0	86.0	5.18
A1005.2	–	5.20	0.2047	52.0	86.0	5.20
A100N5	N5	5.22	0.2055	52.0	86.0	5.22
A1005.25	–	5.25	0.2067	52.0	86.0	5.25
A1005.3	–	5.30	0.2087	52.0	86.0	5.30
A100N4	N4	5.31	0.2090	57.0	93.0	5.31
A1005.4	–	5.40	0.2126	57.0	93.0	5.40
A100N3	N3	5.41	0.2130	57.0	93.0	5.41
A1005.5	–	5.50	0.2165	57.0	93.0	5.50
A1007/32	7/32	5.56	0.2188	57.0	93.0	5.56
A1005.6	–	5.60	0.2205	57.0	93.0	5.60
A100N2	N2	5.61	0.2210	57.0	93.0	5.61
A1005.7	–	5.70	0.2244	57.0	93.0	5.70
A1005.75	–	5.75	0.2264	57.0	93.0	5.75
A100N1	1	5.79	0.2280	57.0	93.0	5.79
A1005.8	–	5.80	0.2283	57.0	93.0	5.80
A1005.9	–	5.90	0.2323	57.0	93.0	5.90
A100A	A	5.94	0.2340	57.0	93.0	5.94
A10015/64	15/64	5.95	0.2344	57.0	93.0	5.95
A1006.0	–	6.00	0.2362	57.0	93.0	6.00
A100B	B	6.03	0.2380	63.0	101.0	6.03
A1006.1	–	6.10	0.2402	63.0	101.0	6.10
A100C	C	6.15	0.2420	63.0	101.0	6.15
A1006.2	–	6.20	0.2441	63.0	101.0	6.20
A1006.25	–	6.25	0.2461	63.0	101.0	6.25
A100D	D	6.25	0.2460	63.0	101.0	6.25
A1006.3	–	6.30	0.2480	63.0	101.0	6.30
A1001/4	1/4	6.35	0.2500	63.0	101.0	6.35
A100E	E	6.35	0.2500	63.0	101.0	6.35
A1006.4	–	6.40	0.2520	63.0	101.0	6.40
A1006.5	–	6.50	0.2559	63.0	101.0	6.50
A100F	F	6.53	0.2570	63.0	101.0	6.53
A1006.6	–	6.60	0.2598	63.0	101.0	6.60
A100G	G	6.63	0.2610	63.0	101.0	6.63
A1006.7	–	6.70	0.2638	63.0	101.0	6.70
A10017/64	17/64	6.75	0.2656	69.0	109.0	6.75
A1006.75	–	6.75	0.2657	69.0	109.0	6.75
A100H	H	6.76	0.2660	69.0	109.0	6.76
A1006.8	–	6.80	0.2677	69.0	109.0	6.80
A1006.9	–	6.90	0.2717	69.0	109.0	6.90
A100I	I	6.91	0.2720	69.0	109.0	6.91
A1007.0	–	7.00	0.2756	69.0	109.0	7.00
A100J	J	7.04	0.2770	69.0	109.0	7.04
A1007.1	–	7.10	0.2795	69.0	109.0	7.10
A1009/32	9/32	7.14	0.2813	69.0	109.0	7.14
A100K	K	7.14	0.2810	69.0	109.0	7.14

Product	DC	DC	DC	LCF	OAL	D CON MS
	(inch)	(mm)	(inch)	(mm)	(mm)	(mm)
A1007.2	–	7.20	0.2835	69.0	109.0	7.20
A1007.25	–	7.25	0.2854	69.0	109.0	7.25
A1007.3	–	7.30	0.2874	69.0	109.0	7.30
A100L	L	7.37	0.2900	69.0	109.0	7.37
A1007.4	–	7.40	0.2913	69.0	109.0	7.40
A100M	M	7.49	0.2949	69.0	109.0	7.49
A1007.5	–	7.50	0.2953	69.0	109.0	7.50
A10019/64	19/64	7.54	0.2969	75.0	117.0	7.54
A1007.6	–	7.60	0.2992	75.0	117.0	7.60
A100N	N	7.67	0.3020	75.0	117.0	7.67
A1007.7	–	7.70	0.3031	75.0	117.0	7.70
A1007.75	–	7.75	0.3051	75.0	117.0	7.75
A1007.8	–	7.80	0.3071	75.0	117.0	7.80
A1007.9	–	7.90	0.3110	75.0	117.0	7.90
A1005/16	5/16	7.94	0.3125	75.0	117.0	7.94
A1008.0	–	8.00	0.3150	75.0	117.0	8.00
A100O	O	8.03	0.3160	75.0	117.0	8.03
A1008.1	–	8.10	0.3189	75.0	117.0	8.10
A1008.2	–	8.20	0.3228	75.0	117.0	8.20
A100P	P	8.20	0.3230	75.0	117.0	8.20
A1008.25	–	8.25	0.3248	75.0	117.0	8.25
A1008.3	–	8.30	0.3268	75.0	117.0	8.30
A10021/64	21/64	8.33	0.3281	75.0	117.0	8.33
A1008.4	–	8.40	0.3307	75.0	117.0	8.40
A100Q	Q	8.43	0.3320	75.0	117.0	8.43
A1008.5	–	8.50	0.3346	75.0	117.0	8.50
A1008.6	–	8.60	0.3386	81.0	125.0	8.60
A100R	R	8.61	0.3390	81.0	125.0	8.61
A1008.7	–	8.70	0.3425	81.0	125.0	8.70
A10011/32	11/32	8.73	0.3438	81.0	125.0	8.73
A1008.75	–	8.75	0.3445	81.0	125.0	8.75
A1008.8	–	8.80	0.3465	81.0	125.0	8.80
A100S	S	8.84	0.3480	81.0	125.0	8.84
A1008.9	–	8.90	0.3504	81.0	125.0	8.90
A1009.0	–	9.00	0.3543	81.0	125.0	9.00
A100T	T	9.09	0.3580	81.0	125.0	9.09
A1009.1	–	9.10	0.3583	81.0	125.0	9.10
A10023/64	23/64	9.13	0.3594	81.0	125.0	9.13
A1009.2	–	9.20	0.3622	81.0	125.0	9.20
A1009.25	–	9.25	0.3642	81.0	125.0	9.25
A1009.3	–	9.30	0.3661	81.0	125.0	9.30
A100U	U	9.35	0.3680	81.0	125.0	9.35
A1009.4	–	9.40	0.3701	81.0	125.0	9.40
A1009.5	–	9.50	0.3740	81.0	125.0	9.50
A1003/8	3/8	9.52	0.3750	87.0	133.0	9.52
A100V	V	9.58	0.3770	87.0	133.0	9.58
A1009.6	–	9.60	0.3780	87.0	133.0	9.60
A1009.7	–	9.70	0.3819	87.0	133.0	9.70
A1009.75	–	9.75	0.3839	87.0	133.0	9.75
A1009.8	–	9.80	0.3858	87.0	133.0	9.80
A100W	W	9.80	0.3860	87.0	133.0	9.80
A1009.9	–	9.90	0.3898	87.0	133.0	9.90
A10025/64	25/64	9.92	0.3906	87.0	133.0	9.92
A10010.0	–	10.00	0.3937	87.0	133.0	10.00
A100X	X	10.08	0.3970	87.0	133.0	10.08
A10010.1	–	10.10	0.3976	87.0	133.0	10.10
A10010.2	–	10.20	0.4016	87.0	133.0	10.20
A10010.25	–	10.25	0.4035	87.0	133.0	10.25
A100Y	Y	10.26	0.4040	87.0	133.0	10.26
A10010.3	–	10.30	0.4055	87.0	133.0	10.30
A10013/32	13/32	10.32	0.4063	87.0	133.0	10.32
A10010.4	–	10.40	0.4094	87.0	133.0	10.40



Product	DC	DC	DC	LCF	OAL	D CON MS
	(inch)	(mm)	(inch)	(mm)	(mm)	(mm)
A100Z	Z	10.49	0.4130	87.0	133.0	10.49
A10010.5	–	10.50	0.4134	87.0	133.0	10.50
A10010.6	–	10.60	0.4173	87.0	133.0	10.60
A10010.7	–	10.70	0.4213	94.0	142.0	10.70
A10027/64	27/64	10.72	0.4219	94.0	142.0	10.72
A10010.75	–	10.75	0.4232	94.0	142.0	10.75
A10010.8	–	10.80	0.4252	94.0	142.0	10.80
A10010.9	–	10.90	0.4291	94.0	142.0	10.90
A10011.0	–	11.00	0.4331	94.0	142.0	11.00
A10011.1	–	11.10	0.4370	94.0	142.0	11.10
A1007/16	7/16	11.11	0.4375	94.0	142.0	11.11
A10011.2	–	11.20	0.4409	94.0	142.0	11.20
A10011.25	–	11.25	0.4429	94.0	142.0	11.25
A10011.3	–	11.30	0.4449	94.0	142.0	11.30
A10011.4	–	11.40	0.4488	94.0	142.0	11.40
A10011.5	–	11.50	0.4528	94.0	142.0	11.50
A10029/64	29/64	11.51	0.4531	94.0	142.0	11.51
A10011.6	–	11.60	0.4567	94.0	142.0	11.60
A10011.7	–	11.70	0.4606	94.0	142.0	11.70
A10011.75	–	11.75	0.4626	94.0	142.0	11.75
A10011.8	–	11.80	0.4646	94.0	142.0	11.80
A10011.9	–	11.90	0.4685	101.0	151.0	11.90
A10015/32	15/32	11.91	0.4688	101.0	151.0	11.91
A10012.0	–	12.00	0.4724	101.0	151.0	12.00
A10012.1	–	12.10	0.4764	101.0	151.0	12.10
A10012.2	–	12.20	0.4803	101.0	151.0	12.20
A10012.25	–	12.25	0.4823	101.0	151.0	12.25
A10012.3	–	12.30	0.4843	101.0	151.0	12.30
A10031/64	31/64	12.30	0.4844	101.0	151.0	12.30
A10012.4	–	12.40	0.4882	101.0	151.0	12.40
A10012.5	–	12.50	0.4921	101.0	151.0	12.50
A10012.6	–	12.60	0.4961	101.0	151.0	12.60
A10012.7	–	12.70	0.5000	101.0	151.0	12.70
A1001/2	1/2	12.70	0.5000	101.0	151.0	12.70
A10012.75	–	12.75	0.5020	101.0	151.0	12.75
A10012.8	–	12.80	0.5039	101.0	151.0	12.80
A10012.9	–	12.90	0.5079	101.0	151.0	12.90
A10013.0	–	13.00	0.5118	101.0	151.0	13.00
A10033/64	33/64	13.10	0.5156	101.0	151.0	13.10

Product	DC	DC	DC	LCF	OAL	D CON MS
	(inch)	(mm)	(inch)	(mm)	(mm)	(mm)
A10013.1	–	13.10	0.5157	101.0	151.0	13.10
A10013.2	–	13.20	0.5197	101.0	151.0	13.20
A10013.25	–	13.25	0.5217	108.0	160.0	13.25
A10013.3	–	13.30	0.5236	108.0	160.0	13.30
A10013.4	–	13.40	0.5276	108.0	160.0	13.40
A10017/32	17/32	13.49	0.5313	108.0	160.0	13.49
A10013.5	–	13.50	0.5315	108.0	160.0	13.50
A10013.6	–	13.60	0.5354	108.0	160.0	13.60
A10013.7	–	13.70	0.5394	108.0	160.0	13.70
A10013.75	–	13.75	0.5413	108.0	160.0	13.75
A10013.8	–	13.80	0.5433	108.0	160.0	13.80
A10035/64	35/64	13.89	0.5469	108.0	160.0	13.89
A10013.9	–	13.90	0.5472	108.0	160.0	13.90
A10014.0	–	14.00	0.5512	108.0	160.0	14.00
A10014.25	–	14.25	0.5610	114.0	169.0	14.25
A1009/16	9/16	14.29	0.5625	114.0	169.0	14.29
A10014.5	–	14.50	0.5709	114.0	169.0	14.50
A10037/64	37/64	14.68	0.5781	114.0	169.0	14.68
A10014.75	–	14.75	0.5807	114.0	169.0	14.75
A10015.0	–	15.00	0.5906	114.0	169.0	15.00
A10019/32	19/32	15.08	0.5938	120.0	178.0	15.08
A10015.25	–	15.25	0.6004	120.0	178.0	15.25
A10039/64	39/64	15.48	0.6094	120.0	178.0	15.48
A10015.5	–	15.50	0.6102	120.0	178.0	15.50
A10015.75	–	15.75	0.6201	120.0	178.0	15.75
A1005/8	5/8	15.88	0.6250	120.0	178.0	15.88
A10016.0	–	16.00	0.6299	120.0	178.0	16.00
A10041/64	41/64	16.27	0.6406	125.0	184.0	16.27
A10016.5	–	16.50	0.6496	125.0	184.0	16.50
A10021/32	21/32	16.67	0.6563	125.0	184.0	16.67
A10017.0	–	17.00	0.6693	125.0	184.0	17.00
A10043/64	43/64	17.07	0.6719	130.0	191.0	17.07
A10011/16	11/16	17.46	0.6875	130.0	191.0	17.46
A10017.5	–	17.50	0.6890	130.0	191.0	17.50
A10018.0	–	18.00	0.7087	130.0	191.0	18.00
A10018.5	–	18.50	0.7283	135.0	198.0	18.50
A10019.0	–	19.00	0.7480	135.0	198.0	19.00
A10019.5	–	19.50	0.7677	140.0	205.0	19.50
A10020.0	–	20.00	0.7874	140.0	205.0	20.00

A110



HSS Long Series Drill, Steam Tempered Finish

For drilling deeper holes. Conventional 118° point provides strength and means an easy point to regrind, making it very cost-effective. Suitable for drilling many materials. Steam tempered finish retains cutting fluid and prevents chip to tool welding. For hand-held and machine drilling.

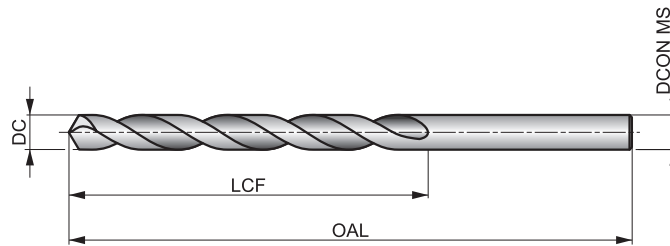

HSS	DIN 340	6xD
118°	ST	
λ 20-35°	R	DC h8

Workpiece material group suitability, starting values for cutting speed (m/min) and feed Alpha Code. Tables with feed per revolution can be found starting from page 71.

P1.1 ■ 27 G	P1.2 ■ 30 G	P1.3 ■ 31 G	P2.1 ■ 23 G	P2.2 ■ 20 E	P2.3 ■ 18 D	P3.1 ■ 13 E	P3.2 ■ 11 E	P3.3 ■ 9 D	P4.1 ■ 8 E	P4.2 ■ 7 D	P4.3 ■ 5 B	M1.1 ■ 14 D	M1.2 ■ 12 D
M2.1 ■ 12 D	M2.2 ■ 10 D	M3.1 ■ 7 F	M3.2 ■ 6 F	M3.3 ■ 5 F	M4.1 ■ 4 B	K1.1 ■ 28 H	K1.2 ■ 21 E	K1.3 ■ 16 E	K2.1 ■ 18 D	K2.2 ■ 15 D	K2.3 ■ 12 D	K3.1 ■ 16 D	K3.2 ■ 12 D
K3.3 ■ 10 D	K4.1 ■ 15 D	K4.2 ■ 11 D	K4.3 ■ 8 D	K4.4 ■ 7 D	K4.5 ■ 6 D	K5.1 ■ 17 D	K5.2 ■ 13 D	K5.3 ■ 10 D	N1.1 ■ 32 I	N1.2 ■ 24 I	N1.3 ■ 16 H	N2.1 ■ 42 G	N2.2 ■ 37 G
N2.3 ■ 27 G	N3.1 ■ 54 G	N3.2 ■ 32 H	N3.3 ■ 16 E	N4.1 ■ 35 I	N4.2 ■ 26 G	N4.3 ■ 12 E	S1.1 ■ 17 E	S1.2 ■ 9 C	S1.3 ■ 4 A	S2.1 ■ 5 D	S2.2 ■ 4 A	S3.1 ■ 4 D	S3.2 ■ 3 A
S4.1 ■ 3 D	S4.2 ■ 2 A												

DC <= 1mm; 1/16" Bright.

Product	DC (inch)	DC (mm)	DC (inch)	LCF (mm)	OAL (mm)	DCON MS (mm)
A110.5	-	0.50	0.0197	12.0	32.0	0.50
A110.6	-	0.60	0.0236	15.0	35.0	0.60
A110.7	-	0.70	0.0276	21.0	42.0	0.70
A1101/32	1/32	0.79	0.0313	25.0	46.0	0.79
A110.8	-	0.80	0.0315	25.0	46.0	0.80
A110.9	-	0.90	0.0354	29.0	51.0	0.90
A1101.0	-	1.00	0.0394	33.0	56.0	1.00
A1101.1	-	1.10	0.0433	37.0	60.0	1.10
A1101.2	-	1.20	0.0472	41.0	65.0	1.20
A1101.3	-	1.30	0.0512	41.0	65.0	1.30
A1101.4	-	1.40	0.0551	45.0	70.0	1.40
A1101.5	-	1.50	0.0591	45.0	70.0	1.50
A1101/16	1/16	1.59	0.0625	50.0	76.0	1.59
A1101.6	-	1.60	0.0630	50.0	76.0	1.60
A1101.7	-	1.70	0.0669	50.0	76.0	1.70
A1101.75	-	1.75	0.0689	53.0	80.0	1.75
A1101.8	-	1.80	0.0709	53.0	80.0	1.80
A1101.9	-	1.90	0.0748	53.0	80.0	1.90
A1105/64	5/64	1.98	0.0781	56.0	85.0	1.98
A1102.0	-	2.00	0.0787	56.0	85.0	2.00
A1102.05	-	2.05	0.0807	56.0	85.0	2.05
A1102.1	-	2.10	0.0827	56.0	85.0	2.10
A1102.2	-	2.20	0.0866	59.0	90.0	2.20
A1102.25	-	2.25	0.0886	59.0	90.0	2.25

Product	DC (inch)	DC (mm)	DC (inch)	LCF (mm)	OAL (mm)	DCON MS (mm)
A1102.3	-	2.30	0.0906	59.0	90.0	2.30
A1103/32	3/32	2.38	0.0938	62.0	95.0	2.38
A1102.4	-	2.40	0.0945	62.0	95.0	2.40
A1102.5	-	2.50	0.0984	62.0	95.0	2.50
A1102.6	-	2.60	0.1024	62.0	95.0	2.60
A1102.7	-	2.70	0.1063	66.0	100.0	2.70
A1107/64	7/64	2.78	0.1094	66.0	100.0	2.78
A1102.8	-	2.80	0.1102	66.0	100.0	2.80
A1102.9	-	2.90	0.1142	66.0	100.0	2.90
A1103.0	-	3.00	0.1181	66.0	100.0	3.00
A1103.1	-	3.10	0.1220	69.0	106.0	3.10
A1101/8	1/8	3.18	0.1250	69.0	106.0	3.18
A1103.2	-	3.20	0.1260	69.0	106.0	3.20
A1103.25	-	3.25	0.1280	69.0	106.0	3.25
A1103.3	-	3.30	0.1299	69.0	106.0	3.30
A1103.4	-	3.40	0.1339	73.0	112.0	3.40
A1103.5	-	3.50	0.1378	73.0	112.0	3.50
A1109/64	9/64	3.57	0.1406	73.0	112.0	3.57
A1103.6	-	3.60	0.1417	73.0	112.0	3.60
A1103.7	-	3.70	0.1457	73.0	112.0	3.70
A1103.75	-	3.75	0.1476	73.0	112.0	3.75
A1103.8	-	3.80	0.1496	78.0	119.0	3.80
A1103.9	-	3.90	0.1535	78.0	119.0	3.90
A1105/32	5/32	3.97	0.1563	78.0	119.0	3.97



Product	DC	DC	DC	LCF	OAL	D CON MS
	(inch)	(mm)	(inch)	(mm)	(mm)	(mm)
A1104.0	–	4.00	0.1575	78.0	119.0	4.00
A1104.1	–	4.10	0.1614	78.0	119.0	4.10
A1104.2	–	4.20	0.1654	78.0	119.0	4.20
A1104.25	–	4.25	0.1673	78.0	119.0	4.25
A1104.3	–	4.30	0.1693	82.0	126.0	4.30
A11011/64	11/64	4.37	0.1719	82.0	126.0	4.37
A1104.4	–	4.40	0.1732	82.0	126.0	4.40
A1104.5	–	4.50	0.1772	82.0	126.0	4.50
A1104.6	–	4.60	0.1811	82.0	126.0	4.60
A1104.7	–	4.70	0.1850	82.0	126.0	4.70
A1104.75	–	4.75	0.1870	82.0	126.0	4.75
A1103/16	3/16	4.76	0.1875	87.0	132.0	4.76
A1104.8	–	4.80	0.1890	87.0	132.0	4.80
A1104.9	–	4.90	0.1929	87.0	132.0	4.90
A1105.0	–	5.00	0.1969	87.0	132.0	5.00
A1105.1	–	5.10	0.2008	87.0	132.0	5.10
A11013/64	13/64	5.16	0.2031	87.0	132.0	5.16
A1105.2	–	5.20	0.2047	87.0	132.0	5.20
A1105.25	–	5.25	0.2067	87.0	132.0	5.25
A1105.3	–	5.30	0.2087	87.0	132.0	5.30
A1105.4	–	5.40	0.2126	91.0	139.0	5.40
A1105.5	–	5.50	0.2165	91.0	139.0	5.50
A1107/32	7/32	5.56	0.2188	91.0	139.0	5.56
A1105.6	–	5.60	0.2205	91.0	139.0	5.60
A1105.7	–	5.70	0.2244	91.0	139.0	5.70
A1105.75	–	5.75	0.2264	91.0	139.0	5.75
A1105.8	–	5.80	0.2283	91.0	139.0	5.80
A1105.9	–	5.90	0.2323	91.0	139.0	5.90
A11015/64	15/64	5.95	0.2344	91.0	139.0	5.95
A1106.0	–	6.00	0.2362	91.0	139.0	6.00
A1106.1	–	6.10	0.2402	97.0	148.0	6.10
A1106.2	–	6.20	0.2441	97.0	148.0	6.20
A1106.25	–	6.25	0.2461	97.0	148.0	6.25
A1106.3	–	6.30	0.2480	97.0	148.0	6.30
A1101/4	1/4	6.35	0.2500	97.0	148.0	6.35
A1106.4	–	6.40	0.2520	97.0	148.0	6.40
A1106.5	–	6.50	0.2559	97.0	148.0	6.50
A1106.6	–	6.60	0.2598	97.0	148.0	6.60
A1106.7	–	6.70	0.2638	97.0	148.0	6.70
A11017/64	17/64	6.75	0.2656	102.0	156.0	6.75
A1106.75	–	6.75	0.2657	102.0	156.0	6.75
A1106.8	–	6.80	0.2677	102.0	156.0	6.80
A1106.9	–	6.90	0.2717	102.0	156.0	6.90
A1107.0	–	7.00	0.2756	102.0	156.0	7.00
A1107.1	–	7.10	0.2795	102.0	156.0	7.10
A1109/32	9/32	7.14	0.2813	102.0	156.0	7.14
A1107.2	–	7.20	0.2835	102.0	156.0	7.20
A1107.25	–	7.25	0.2854	102.0	156.0	7.25
A1107.3	–	7.30	0.2874	102.0	156.0	7.30
A1107.4	–	7.40	0.2913	102.0	156.0	7.40
A1107.5	–	7.50	0.2953	102.0	156.0	7.50
A1107.6	–	7.60	0.2992	109.0	165.0	7.60
A1107.7	–	7.70	0.3031	109.0	165.0	7.70
A1107.75	–	7.75	0.3051	109.0	165.0	7.75
A1107.8	–	7.80	0.3071	109.0	165.0	7.80
A1107.9	–	7.90	0.3110	109.0	165.0	7.90
A1105/16	5/16	7.94	0.3125	109.0	165.0	7.94
A1108.0	–	8.00	0.3150	109.0	165.0	8.00
A1108.1	–	8.10	0.3189	109.0	165.0	8.10
A1108.2	–	8.20	0.3228	109.0	165.0	8.20
A1108.25	–	8.25	0.3248	109.0	165.0	8.25
A1108.3	–	8.30	0.3268	109.0	165.0	8.30
A1108.4	–	8.40	0.3307	109.0	165.0	8.40
A1108.5	–	8.50	0.3346	109.0	165.0	8.50
A1108.6	–	8.60	0.3386	115.0	175.0	8.60

Product	DC	DC	DC	LCF	OAL	D CON MS
	(inch)	(mm)	(inch)	(mm)	(mm)	(mm)
A1108.7	–	8.70	0.3425	115.0	175.0	8.70
A11011/32	11/32	8.73	0.3438	115.0	175.0	8.73
A1108.75	–	8.75	0.3445	115.0	175.0	8.75
A1108.8	–	8.80	0.3465	115.0	175.0	8.80
A1108.9	–	8.90	0.3504	115.0	175.0	8.90
A1109.0	–	9.00	0.3543	115.0	175.0	9.00
A1109.1	–	9.10	0.3583	115.0	175.0	9.10
A1109.2	–	9.20	0.3622	115.0	175.0	9.20
A1109.25	–	9.25	0.3642	115.0	175.0	9.25
A1109.3	–	9.30	0.3661	115.0	175.0	9.30
A1109.4	–	9.40	0.3701	115.0	175.0	9.40
A1109.5	–	9.50	0.3740	115.0	175.0	9.50
A1103/8	3/8	9.52	0.3750	121.0	184.0	9.52
A1109.6	–	9.60	0.3780	121.0	184.0	9.60
A1109.7	–	9.70	0.3819	121.0	184.0	9.70
A1109.75	–	9.75	0.3839	121.0	184.0	9.75
A1109.8	–	9.80	0.3858	121.0	184.0	9.80
A1109.9	–	9.90	0.3898	121.0	184.0	9.90
A11010.0	–	10.00	0.3937	121.0	184.0	10.00
A11010.1	–	10.10	0.3976	121.0	184.0	10.10
A11010.2	–	10.20	0.4016	121.0	184.0	10.20
A11010.25	–	10.25	0.4035	121.0	184.0	10.25
A11010.3	–	10.30	0.4055	121.0	184.0	10.30
A11013/32	13/32	10.32	0.4063	121.0	184.0	10.32
A11010.5	–	10.50	0.4134	121.0	184.0	10.50
A11010.75	–	10.75	0.4232	128.0	195.0	10.75
A11010.8	–	10.80	0.4252	128.0	195.0	10.80
A11011.0	–	11.00	0.4331	128.0	195.0	11.00
A1107/16	7/16	11.11	0.4375	128.0	195.0	11.11
A11011.25	–	11.25	0.4429	128.0	195.0	11.25
A11011.4	–	11.40	0.4488	128.0	195.0	11.40
A11011.5	–	11.50	0.4528	128.0	195.0	11.50
A11011.75	–	11.75	0.4626	128.0	195.0	11.75
A11012.0	–	12.00	0.4724	134.0	205.0	12.00
A11012.1	–	12.10	0.4764	134.0	205.0	12.10
A11012.25	–	12.25	0.4823	134.0	205.0	12.25
A11012.5	–	12.50	0.4921	134.0	205.0	12.50
A1101/2	1/2	12.70	0.5000	134.0	205.0	12.70
A11013.0	–	13.00	0.5118	134.0	205.0	13.00
A11017/32	17/32	13.49	0.5313	140.0	214.0	13.49
A11013.5	–	13.50	0.5315	140.0	214.0	13.50
A11014.0	–	14.00	0.5512	140.0	214.0	14.00
A1109/16	9/16	14.29	0.5625	144.0	220.0	14.29
A11014.5	–	14.50	0.5709	144.0	220.0	14.50
A11015.0	–	15.00	0.5906	144.0	220.0	15.00
A11015.5	–	15.50	0.6102	149.0	227.0	15.50
A1105/8	5/8	15.88	0.6250	149.0	227.0	15.88
A11016.0	–	16.00	0.6299	149.0	227.0	16.00
A11016.5	–	16.50	0.6496	154.0	235.0	16.50
A11017.0	–	17.00	0.6693	154.0	235.0	17.00
A11011/16	11/16	17.46	0.6875	158.0	241.0	17.46
A11017.5	–	17.50	0.6890	158.0	241.0	17.50
A11018.0	–	18.00	0.7087	158.0	241.0	18.00
A11018.5	–	18.50	0.7283	162.0	247.0	18.50
A11019.0	–	19.00	0.7480	162.0	247.0	19.00
A1103/4	3/4	19.05	0.7500	166.0	254.0	19.05
A11019.5	–	19.50	0.7677	166.0	254.0	19.50
A11020.0	–	20.00	0.7874	166.0	254.0	20.00
A11021.0	–	21.00	0.8268	171.0	261.0	21.00
A11022.0	–	22.00	0.8661	176.0	268.0	22.00
A1107/8	7/8	22.22	0.8750	176.0	268.0	22.22
A11015/16	15/16	23.81	0.9375	185.0	282.0	23.81
A1101	1"	25.40	1.0000	190.0	290.0	25.40

A125



HSS Extra Long Series Drill, Steam Tempered Finish

With Steam tempered finish and recommended for very deep or difficult to reach holes. Conventional 118° point, providing strength and saving money on easy regrinds. Suitable for many materials. Steam tempered finish retains cutting fluid and prevents chip to tool welding. Less suitable for hand-held drilling.

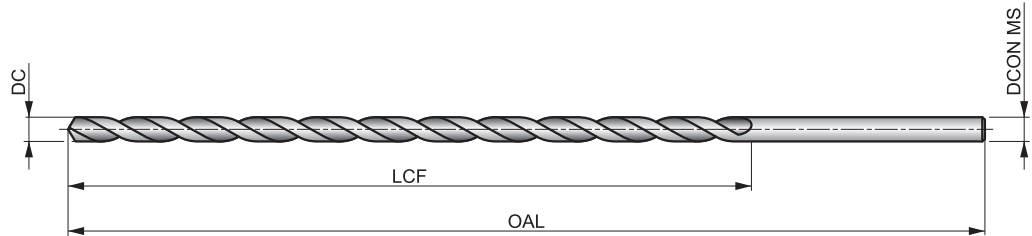

HSS	BS 328	10×D
118°	ST	
λ 20-35°	R	DC h8

Workpiece material group suitability, starting values for cutting speed (m/min) and feed Alpha Code. Tables with feed per revolution can be found starting from page 71.

P1.1 ■ 21 E	P1.2 ■ 24 E	P1.3 ■ 25 E	P2.1 ■ 18 E	P2.2 ■ 16 C	P2.3 ■ 14 A	P3.1 ■ 9 C	P3.2 ■ 7 C	P3.3 ■ 6 A	P4.1 ■ 5 C	P4.2 ■ 4 A	P4.3 ■ 4 A	M1.1 ■ 12 C	M1.2 ■ 10 C
M2.1 ■ 11 C	M2.2 ■ 9 C	M3.1 ■ 5 E	M3.2 ■ 4 E	M3.3 ■ 4 E	M4.1 ■ 8 A	K1.1 ■ 22 G	K1.2 ■ 16 D	K1.3 ■ 12 D	K2.1 ■ 16 C	K2.2 ■ 13 C	K2.3 ■ 10 C	K3.1 ■ 14 C	K3.2 ■ 11 C
K3.3 ■ 9 C	K4.1 ■ 13 C	K4.2 ■ 10 C	K4.3 ■ 7 C	K4.4 ■ 6 C	K4.5 ■ 5 C	K5.1 ■ 15 C	K5.2 ■ 11 C	K5.3 ■ 9 C	N1.1 ■ 24 H	N1.2 ■ 18 H	N1.3 ■ 12 G	N2.1 ■ 34 F	N2.2 ■ 30 F
N2.3 ■ 22 F	N3.1 ■ 56 F	N3.2 ■ 33 G	N3.3 ■ 17 D	N4.1 ■ 30 H	N4.2 ■ 26 F	N4.3 ■ 10 D	S1.1 ■ 11 D	S1.2 ■ 9 B	S1.3 ■ 5 A	S2.1 ■ 5 C	S2.2 ■ 4 A	S3.1 ■ 4 C	S3.2 ■ 3 A
S4.1 ■ 3 C	S4.2 ■ 2 A												

DC <= 2.2mm; 5/64" Bright.

Product	DC (inch)	DC (mm)	DC (inch)	LCF (mm)	OAL (mm)	DCON MS (mm)
A1251.4X160	-	1.40	0.0551	100.0	160.0	1.40
A1251.5X125	-	1.50	0.0591	80.0	125.0	1.50
A1251.5X160	-	1.50	0.0591	100.0	160.0	1.50
A1251/16X125	1/16	1.59	0.0625	80.0	125.0	1.59
A1251/16X160	1/16	1.59	0.0625	100.0	160.0	1.59
A1251.8X160	-	1.80	0.0709	100.0	160.0	1.80
A1255/64X125	5/64	1.98	0.0781	80.0	125.0	1.98
A1255/64X160	5/64	1.98	0.0781	100.0	160.0	1.98
A1252.0X125	-	2.00	0.0787	80.0	125.0	2.00
A1252.0X160	-	2.00	0.0787	100.0	160.0	2.00
A1252.2X160	-	2.20	0.0866	100.0	160.0	2.20
A1253/32X125	3/32	2.38	0.0938	80.0	125.0	2.38
A1253/32X160	3/32	2.38	0.0938	100.0	160.0	2.38
A1252.5X125	-	2.50	0.0984	80.0	125.0	2.50
A1252.5X160	-	2.50	0.0984	100.0	160.0	2.50
A1257/64X125	7/64	2.78	0.1094	80.0	125.0	2.78
A1257/64X160	7/64	2.78	0.1094	100.0	160.0	2.78
A1253.0X160	-	3.00	0.1181	100.0	160.0	3.00
A1253.0X200	-	3.00	0.1181	150.0	200.0	3.00
A1253.0X250	-	3.00	0.1181	200.0	250.0	3.00
A1251/8X160	1/8	3.18	0.1252	100.0	160.0	3.18
A1251/8X200	1/8	3.18	0.1252	150.0	200.0	3.18
A1251/8X250	1/8	3.18	0.1252	200.0	250.0	3.18
A1251/8X315	1/8	3.18	0.1252	250.0	310.0	3.18
A1253.3X160	-	3.30	0.1299	100.0	160.0	3.30
A1253.5X160	-	3.50	0.1378	100.0	160.0	3.50

Product	DC (inch)	DC (mm)	DC (inch)	LCF (mm)	OAL (mm)	DCON MS (mm)
A1253.5X200	-	3.50	0.1378	150.0	200.0	3.50
A1253.5X250	-	3.50	0.1378	200.0	250.0	3.50
A1259/64X160	9/64	3.57	0.1406	100.0	160.0	3.57
A1259/64X200	9/64	3.57	0.1406	150.0	200.0	3.57
A1259/64X315	9/64	3.57	0.1406	250.0	310.0	3.57
A1255/32X160	5/32	3.97	0.1563	100.0	160.0	3.97
A1255/32X200	5/32	3.97	0.1563	150.0	200.0	3.97
A1255/32X250	5/32	3.97	0.1563	200.0	250.0	3.97
A1255/32X315	5/32	3.97	0.1563	250.0	310.0	3.97
A1254.0X160	-	4.00	0.1575	100.0	160.0	4.00
A1254.0X200	-	4.00	0.1575	150.0	200.0	4.00
A1254.0X250	-	4.00	0.1575	200.0	250.0	4.00
A1254.0X315	-	4.00	0.1575	250.0	310.0	4.00
A12511/64X160	11/64	4.37	0.1719	100.0	160.0	4.37
A12511/64X200	11/64	4.37	0.1719	150.0	200.0	4.37
A12511/64X315	11/64	4.37	0.1719	250.0	310.0	4.37
A1254.5X160	-	4.50	0.1772	100.0	160.0	4.50
A1254.5X200	-	4.50	0.1772	150.0	200.0	4.50
A1254.5X250	-	4.50	0.1772	200.0	250.0	4.50
A1254.5X315	-	4.50	0.1772	250.0	310.0	4.50
A1253/16X160	3/16	4.76	0.1875	100.0	160.0	4.76
A1253/16X200	3/16	4.76	0.1875	150.0	200.0	4.76
A1253/16X250	3/16	4.76	0.1875	200.0	250.0	4.76
A1253/16X315	3/16	4.76	0.1875	250.0	310.0	4.76
A1253/16X400	3/16	4.76	0.1875	300.0	400.0	4.76
A1255.0X160	-	5.00	0.1969	100.0	160.0	5.00



Product	DC	DC	DC	LCF	OAL	DCON MS
	(inch)	(mm)	(inch)	(mm)	(mm)	(mm)
A1255.0X200	—	5.00	0.1969	150.0	200.0	5.00
A1255.0X250	—	5.00	0.1969	200.0	250.0	5.00
A1255.0X315	—	5.00	0.1969	250.0	310.0	5.00
A1255.0X400	—	5.00	0.1969	300.0	400.0	5.00
A12513/64X200	13/64	5.16	0.2031	150.0	200.0	5.16
A12513/64X250	13/64	5.16	0.2031	200.0	250.0	5.16
A12513/64X315	13/64	5.16	0.2031	250.0	310.0	5.16
A1255.5X200	—	5.50	0.2165	150.0	200.0	5.50
A1255.5X250	—	5.50	0.2165	200.0	250.0	5.50
A1255.5X315	—	5.50	0.2165	250.0	310.0	5.50
A1257/32X200	7/32	5.56	0.2188	150.0	200.0	5.56
A1257/32X250	7/32	5.56	0.2188	200.0	250.0	5.56
A1257/32X315	7/32	5.56	0.2188	250.0	310.0	5.56
A12515/64X200	15/64	5.95	0.2344	150.0	200.0	5.95
A12515/64X250	15/64	5.95	0.2344	200.0	250.0	5.95
A12515/64X315	15/64	5.95	0.2344	250.0	310.0	5.95
A1256.0X200	—	6.00	0.2362	150.0	200.0	6.00
A1256.0X250	—	6.00	0.2362	200.0	250.0	6.00
A1256.0X315	—	6.00	0.2362	250.0	310.0	6.00
A1256.0X400	—	6.00	0.2362	300.0	400.0	6.00
A1251/4X200	1/4	6.35	0.2500	150.0	200.0	6.35
A1251/4X250	1/4	6.35	0.2500	200.0	250.0	6.35
A1251/4X315	1/4	6.35	0.2500	250.0	310.0	6.35
A1251/4X400	1/4	6.35	0.2500	300.0	400.0	6.35
A1251/4X500	1/4	6.35	0.2500	400.0	460.0	6.35
A1256.5X200	—	6.50	0.2559	150.0	200.0	6.50
A1256.5X250	—	6.50	0.2559	200.0	250.0	6.50
A1256.5X315	—	6.50	0.2559	250.0	310.0	6.50
A12517/64X200	17/64	6.75	0.2656	150.0	200.0	6.75
A12517/64X250	17/64	6.75	0.2656	200.0	250.0	6.75
A12517/64X500	17/64	6.75	0.2656	400.0	460.0	6.75
A1257.0X200	—	7.00	0.2756	150.0	200.0	7.00
A1257.0X250	—	7.00	0.2756	200.0	250.0	7.00
A1257.0X315	—	7.00	0.2756	250.0	310.0	7.00
A1259/32X200	9/32	7.14	0.2813	150.0	200.0	7.14
A1259/32X250	9/32	7.14	0.2813	200.0	250.0	7.14
A1259/32X315	9/32	7.14	0.2813	250.0	310.0	7.14
A1259/32X500	9/32	7.14	0.2813	400.0	460.0	7.14
A1257.5X200	—	7.50	0.2953	150.0	200.0	7.50
A1257.5X250	—	7.50	0.2953	200.0	250.0	7.50
A1257.5X315	—	7.50	0.2953	250.0	310.0	7.50
A12519/64X315	19/64	7.54	0.2969	250.0	310.0	7.54
A12519/64X500	19/64	7.54	0.2969	400.0	460.0	7.54
A1255/16X200	5/16	7.94	0.3125	150.0	200.0	7.94
A1255/16X250	5/16	7.94	0.3125	200.0	250.0	7.94
A1255/16X315	5/16	7.94	0.3125	250.0	310.0	7.94
A1255/16X400	5/16	7.94	0.3125	300.0	400.0	7.94
A1255/16X500	5/16	7.94	0.3125	400.0	460.0	7.94
A1258.0X250	—	8.00	0.3150	200.0	250.0	8.00
A1258.0X315	—	8.00	0.3150	250.0	310.0	8.00
A1258.0X400	—	8.00	0.3150	300.0	400.0	8.00
A12521/64X315	21/64	8.33	0.3281	250.0	310.0	8.33
A12521/64X500	21/64	8.33	0.3281	400.0	460.0	8.33
A1258.5X250	—	8.50	0.3346	200.0	250.0	8.50
A1258.5X315	—	8.50	0.3346	250.0	310.0	8.50
A12511/32X250	11/32	8.73	0.3438	200.0	250.0	8.73
A12511/32X315	11/32	8.73	0.3438	250.0	310.0	8.73
A12511/32X400	11/32	8.73	0.3438	300.0	400.0	8.73
A12511/32X500	11/32	8.73	0.3438	400.0	460.0	8.73
A1259.0X250	—	9.00	0.3543	200.0	250.0	9.00
A1259.0X315	—	9.00	0.3543	250.0	310.0	9.00
A1259.0X400	—	9.00	0.3543	300.0	400.0	9.00
A12523/64X315	23/64	9.13	0.3594	250.0	310.0	9.13
A12523/64X500	23/64	9.13	0.3594	400.0	460.0	9.13
A1259.5X250	—	9.50	0.3740	200.0	250.0	9.50
A1259.5X315	—	9.50	0.3740	250.0	310.0	9.50
A1253/8X250	3/8	9.52	0.3750	200.0	250.0	9.52
A1253/8X315	3/8	9.52	0.3750	250.0	310.0	9.52
A1253/8X400	3/8	9.52	0.3750	300.0	400.0	9.52

Product	DC	DC	DC	LCF	OAL	DCON MS
	(inch)	(mm)	(inch)	(mm)	(mm)	(mm)
A1253/8X500	3/8	9.52	0.3750	400.0	460.0	9.52
A12525/64X315	25/64	9.92	0.3906	250.0	310.0	9.92
A12525/64X500	25/64	9.92	0.3906	400.0	460.0	9.92
A12510.0X250	—	10.00	0.3937	200.0	250.0	10.00
A12510.0X315	—	10.00	0.3937	250.0	310.0	10.00
A12510.0X400	—	10.00	0.3937	300.0	400.0	10.00
A12513/32X250	13/32	10.32	0.4063	200.0	250.0	10.32
A12513/32X315	13/32	10.32	0.4063	250.0	310.0	10.32
A12513/32X500	13/32	10.32	0.4063	400.0	460.0	10.32
A12510.5X250	—	10.50	0.4134	200.0	250.0	10.50
A12510.5X315	—	10.50	0.4134	250.0	310.0	10.50
A12510.5X400	—	10.50	0.4134	300.0	400.0	10.50
A12527/64X315	27/64	10.72	0.4219	250.0	310.0	10.72
A12511.0X250	—	11.00	0.4331	200.0	250.0	11.00
A12511.0X315	—	11.00	0.4331	250.0	310.0	11.00
A12511.0X400	—	11.00	0.4331	300.0	400.0	11.00
A1257/16X250	7/16	11.11	0.4375	200.0	250.0	11.11
A1257/16X315	7/16	11.11	0.4375	250.0	310.0	11.11
A1257/16X400	7/16	11.11	0.4375	300.0	400.0	11.11
A1257/16X500	7/16	11.11	0.4375	400.0	460.0	11.11
A12529/64X315	29/64	11.51	0.4531	250.0	310.0	11.51
A12529/64X500	29/64	11.51	0.4531	400.0	460.0	11.51
A12515/32X250	15/32	11.91	0.4688	200.0	250.0	11.91
A12515/32X315	15/32	11.91	0.4688	250.0	310.0	11.91
A12515/32X500	15/32	11.91	0.4688	400.0	460.0	11.91
A12512.0X250	—	12.00	0.4724	200.0	250.0	12.00
A12512.0X315	—	12.00	0.4724	250.0	310.0	12.00
A12512.0X400	—	12.00	0.4724	300.0	400.0	12.00
A12531/64X315	31/64	12.30	0.4844	250.0	310.0	12.30
A12531/64X500	31/64	12.30	0.4844	400.0	460.0	12.30
A1251/2X250	1/2	12.70	0.5000	200.0	250.0	12.70
A1251/2X315	1/2	12.70	0.5000	250.0	310.0	12.70
A1251/2X400	1/2	12.70	0.5000	300.0	400.0	12.70
A1251/2X500	1/2	12.70	0.5000	400.0	460.0	12.70
A12513.0X315	—	13.00	0.5118	250.0	310.0	13.00
A12513.0X400	—	13.00	0.5118	300.0	400.0	13.00
A12533/64X315	33/64	13.10	0.5156	250.0	310.0	13.10
A12533/64X500	33/64	13.10	0.5156	400.0	460.0	13.10
A12517/32X315	17/32	13.49	0.5313	250.0	310.0	13.49
A12517/32X500	17/32	13.49	0.5313	400.0	460.0	13.49
A12535/64X315	35/64	13.89	0.5469	250.0	310.0	13.89
A12535/64X500	35/64	13.89	0.5469	400.0	460.0	13.89
A12514.0X315	—	14.00	0.5512	250.0	310.0	14.00
A12514.0X400	—	14.00	0.5512	300.0	400.0	14.00
A1259/16X315	9/16	14.29	0.5625	250.0	310.0	14.29
A1259/16X500	9/16	14.29	0.5625	400.0	460.0	14.29
A12537/64X315	37/64	14.68	0.5781	250.0	310.0	14.68
A12519/32X315	19/32	15.08	0.5938	250.0	310.0	15.08
A12519/32X500	19/32	15.08	0.5938	400.0	460.0	15.08
A12539/64X315	39/64	15.48	0.6094	250.0	310.0	15.48
A12539/64X500	39/64	15.48	0.6094	400.0	460.0	15.48
A1255/8X315	5/8	15.88	0.6250	250.0	310.0	15.88
A1255/8X500	5/8	15.88	0.6250	400.0	460.0	15.88
A12521/32X315	21/32	16.67	0.6563	250.0	310.0	16.67
A12521/32X500	21/32	16.67	0.6563	400.0	460.0	16.67
A12511/16X315	11/16	17.46	0.6875	250.0	310.0	17.46
A12511/16X500	11/16	17.46	0.6875	400.0	460.0	17.46
A12523/32X315	23/32	18.26	0.7188	250.0	310.0	18.26
A12523/32X500	23/32	18.26	0.7188	400.0	460.0	18.26
A1253/4X315	3/4	19.05	0.7500	250.0	310.0	19.05
A1253/4X500	3/4	19.05	0.7500	400.0	460.0	19.05
A12525/32X500	25/32	19.84	0.7813	400.0	460.0	19.84
A12513/16X500	13/16	20.64	0.8125	400.0	460.0	20.64
A1257/8X500	7/8	22.22	0.8750	400.0	460.0	22.22
A12515/16X500	15/16	23.81	0.9375	400.0	460.0	23.81
A1251X500	1"	25.40	1.0000	400.0	460.0	25.40

A022

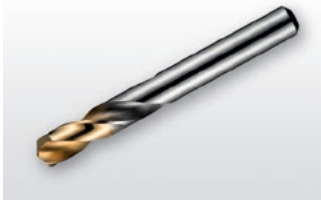

HSS Stub Drill, TiN-Tip Coated

Versatile drill with a specially designed 135° split point which helps self-centering when drilling by hand and in machines provides a more accurate hole with a better quality of finish. Suitable for drilling many materials. TiN-Tip coating improves performance and extends the tool life.

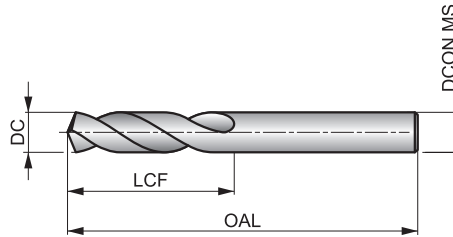

HSS	DIN ANSI	2.5×D
135°	TiN-Tip	
λ 20-35°	R	DC h8

Workpiece material group suitability, starting values for cutting speed (m/min) and feed Alpha Code. Tables with feed per revolution can be found starting from page 71.

P1.1 ■ 33 K	P1.2 ■ 37 K	P1.3 ■ 38 K	P2.1 ■ 28 K	P2.2 ■ 25 I	P2.3 ■ 22 G	P3.1 ■ 24 H	P3.2 ■ 19 H	P3.3 ■ 16 G	P4.1 ■ 14 H	P4.2 ■ 12 G	P4.3 ▣ 10 E	M1.1 ■ 21 G	M1.2 ■ 17 G
M2.1 ■ 18 G	M2.2 ■ 15 G	M3.1 ▣ 9 I	M3.2 ▣ 8 I	M3.3 ▣ 7 I	M4.1 ▣ 9 E	K1.1 ■ 32 K	K1.2 ■ 24 I	K1.3 ■ 18 I	K2.1 ■ 25 G	K2.2 ■ 20 G	K2.3 ▣ 16 G	K3.1 ■ 22 G	K3.2 ■ 17 G
K3.3 ▣ 13 G	K4.1 ■ 20 G	K4.2 ■ 15 G	K4.3 ▣ 11 G	K4.4 ▣ 10 G	K4.5 ▣ 8 G	K5.1 ■ 23 G	K5.2 ■ 17 G	K5.3 ▣ 13 G	N1.1 ■ 40 F	N1.2 ■ 30 F	N1.3 ■ 20 K	N2.1 ■ 49 J	N2.2 ■ 44 J
N2.3 ■ 32 J	N3.1 ▣ 64 I	N3.2 ▣ 38 K	N3.3 ▣ 19 H	N4.1 ▣ 30 K	N4.2 ▣ 35 I	N4.3 ▣ 17 G	S1.1 ■ 25 I	S1.2 ▣ 14 F	S1.3 ▣ 8 C	S2.1 ▣ 11 F	S2.2 ▣ 6 B	S3.1 ▣ 8 F	S3.2 ▣ 4 B
S4.1 ▣ 6 F	S4.2 ▣ 3 B												

DC < 2mm Bright; DC >= 2mm TiN Tipped and Split Point.
Products from this series are also available in set. Please see A088.

Product	DC (inch)	DC (mm)	DC (inch)	LCF (mm)	OAL (mm)	DCON MS (mm)
A022.5	—	0.50	0.0197	3.0	20.0	0.50
A022.6	—	0.60	0.0236	3.5	21.0	0.60
A022.7	—	0.70	0.0276	4.5	23.0	0.70
A0221/32	1/32	0.79	0.0313	13.0	35.0	0.79
A022.8	—	0.80	0.0315	5.0	24.0	0.80
A022.9	—	0.90	0.0354	5.5	25.0	0.90
A0221.0	—	1.00	0.0394	6.0	26.0	1.00
A0221.1	—	1.10	0.0433	7.0	28.0	1.10
A0223/64	3/64	1.19	0.0469	13.0	35.0	1.19
A0221.2	—	1.20	0.0472	8.0	30.0	1.20
A0221.3	—	1.30	0.0512	8.0	30.0	1.30
A0221.4	—	1.40	0.0551	9.0	32.0	1.40
A0221.5	—	1.50	0.0591	9.0	32.0	1.50
A0221/16	1/16	1.59	0.0625	16.0	41.0	1.59
A0221.6	—	1.60	0.0630	10.0	34.0	1.60
A0221.7	—	1.70	0.0669	10.0	34.0	1.70
A0221.8	—	1.80	0.0709	11.0	36.0	1.80
A0221.9	—	1.90	0.0748	11.0	36.0	1.90
A0225/64	5/64	1.98	0.0781	17.0	43.0	1.98
A0222.0	—	2.00	0.0787	12.0	38.0	2.00
A0222.1	—	2.10	0.0827	12.0	38.0	2.10
A0222.2	—	2.20	0.0866	13.0	40.0	2.20

Product	DC (inch)	DC (mm)	DC (inch)	LCF (mm)	OAL (mm)	DCON MS (mm)
A0222.25	—	2.25	0.0886	13.0	40.0	2.25
A0222.3	—	2.30	0.0906	13.0	40.0	2.30
A0223/32	3/32	2.38	0.0938	20.0	45.0	2.38
A0222.4	—	2.40	0.0945	14.0	43.0	2.40
A0222.5	—	2.50	0.0984	14.0	43.0	2.50
A0222.6	—	2.60	0.1024	14.0	43.0	2.60
A0222.65	—	2.65	0.1043	14.0	43.0	2.65
A0222.7	—	2.70	0.1063	16.0	46.0	2.70
A0227/64	7/64	2.78	0.1094	22.0	47.0	2.78
A0222.8	—	2.80	0.1102	16.0	46.0	2.80
A0222.9	—	2.90	0.1142	16.0	46.0	2.90
A0223.0	—	3.00	0.1181	16.0	46.0	3.00
A0223.1	—	3.10	0.1220	18.0	49.0	3.10
A0221/8	1/8	3.18	0.1250	23.0	49.0	3.18
A0223.2	—	3.20	0.1260	18.0	49.0	3.20
A0223.25	—	3.25	0.1280	18.0	49.0	3.25
A0223.3	—	3.30	0.1299	18.0	49.0	3.30
A0223.4	—	3.40	0.1339	20.0	52.0	3.40
A0223.5	—	3.50	0.1378	20.0	52.0	3.50
A0229/64	9/64	3.57	0.1406	25.0	50.0	3.57
A0223.6	—	3.60	0.1417	20.0	52.0	3.60
A0223.7	—	3.70	0.1457	20.0	52.0	3.70



Product	DC	DC	DC	LCF	OAL	D CON MS
	(inch)	(mm)	(inch)	(mm)	(mm)	(mm)
A0223.8	–	3.80	0.1496	22.0	55.0	3.80
A0223.9	–	3.90	0.1535	22.0	55.0	3.90
A0225/32	5/32	3.97	0.1563	26.0	53.0	3.97
A0224.0	–	4.00	0.1575	22.0	55.0	4.00
A0224.1	–	4.10	0.1614	22.0	55.0	4.10
A0224.2	–	4.20	0.1654	22.0	55.0	4.20
A0224.3	–	4.30	0.1693	24.0	58.0	4.30
A02211/64	11/64	4.37	0.1719	28.0	55.0	4.37
A0224.4	–	4.40	0.1732	24.0	58.0	4.40
A0224.5	–	4.50	0.1772	24.0	58.0	4.50
A0224.6	–	4.60	0.1811	24.0	58.0	4.60
A0224.7	–	4.70	0.1850	24.0	58.0	4.70
A0223/16	3/16	4.76	0.1875	30.0	57.0	4.76
A0224.8	–	4.80	0.1890	26.0	62.0	4.80
A0224.9	–	4.90	0.1929	26.0	62.0	4.90
A0225.0	–	5.00	0.1969	26.0	62.0	5.00
A0225.1	–	5.10	0.2008	26.0	62.0	5.10
A02213/64	13/64	5.16	0.2031	31.0	58.0	5.16
A0225.2	–	5.20	0.2047	26.0	62.0	5.20
A0225.3	–	5.30	0.2087	26.0	62.0	5.30
A0225.4	–	5.40	0.2126	28.0	66.0	5.40
A0225.5	–	5.50	0.2165	28.0	66.0	5.50
A0227/32	7/32	5.56	0.2188	33.0	61.0	5.56
A0225.6	–	5.60	0.2205	28.0	66.0	5.60
A0225.7	–	5.70	0.2244	28.0	66.0	5.70
A0225.8	–	5.80	0.2283	28.0	66.0	5.80
A0225.9	–	5.90	0.2323	28.0	66.0	5.90
A02215/64	15/64	5.95	0.2344	34.0	63.0	5.95
A0226.0	–	6.00	0.2362	28.0	66.0	6.00
A0226.1	–	6.10	0.2402	31.0	70.0	6.10
A0226.2	–	6.20	0.2441	31.0	70.0	6.20
A0226.3	–	6.30	0.2480	31.0	70.0	6.30
A0221/4	1/4	6.35	0.2500	36.0	65.0	6.35
A0226.4	–	6.40	0.2520	31.0	70.0	6.40
A0226.5	–	6.50	0.2559	31.0	70.0	6.50
A0226.6	–	6.60	0.2598	31.0	70.0	6.60
A0226.7	–	6.70	0.2638	31.0	70.0	6.70
A0226.8	–	6.80	0.2677	34.0	74.0	6.80
A0226.9	–	6.90	0.2717	34.0	74.0	6.90
A0227.0	–	7.00	0.2756	34.0	74.0	7.00
A0227.1	–	7.10	0.2795	34.0	74.0	7.10
A0229/32	9/32	7.14	0.2813	40.0	70.0	7.14
A0227.2	–	7.20	0.2835	34.0	74.0	7.20
A0227.3	–	7.30	0.2874	34.0	74.0	7.30
A0227.4	–	7.40	0.2913	34.0	74.0	7.40
A0227.5	–	7.50	0.2953	34.0	74.0	7.50
A0227.6	–	7.60	0.2992	37.0	79.0	7.60
A0227.7	–	7.70	0.3031	37.0	79.0	7.70
A0227.8	–	7.80	0.3071	37.0	79.0	7.80
A0227.9	–	7.90	0.3110	37.0	79.0	7.90
A0225/16	5/16	7.94	0.3125	43.0	73.0	7.94
A0228.0	–	8.00	0.3150	37.0	79.0	8.00
A0228.1	–	8.10	0.3189	37.0	79.0	8.10
A0228.2	–	8.20	0.3228	37.0	79.0	8.20

Product	DC	DC	DC	LCF	OAL	D CON MS
	(inch)	(mm)	(inch)	(mm)	(mm)	(mm)
A0228.3	–	8.30	0.3268	37.0	79.0	8.30
A0228.4	–	8.40	0.3307	37.0	79.0	8.40
A0228.5	–	8.50	0.3346	37.0	79.0	8.50
A0228.6	–	8.60	0.3386	40.0	84.0	8.60
A0228.7	–	8.70	0.3425	40.0	84.0	8.70
A02211/32	11/32	8.73	0.3438	45.0	78.0	8.73
A0228.8	–	8.80	0.3465	40.0	84.0	8.80
A0228.9	–	8.90	0.3504	40.0	84.0	8.90
A0229.0	–	9.00	0.3543	40.0	84.0	9.00
A0229.1	–	9.10	0.3583	40.0	84.0	9.10
A0229.2	–	9.20	0.3622	40.0	84.0	9.20
A0229.3	–	9.30	0.3661	40.0	84.0	9.30
A0229.4	–	9.40	0.3701	40.0	84.0	9.40
A0229.5	–	9.50	0.3740	40.0	84.0	9.50
A0223/8	3/8	9.52	0.3750	48.0	81.0	9.52
A0229.6	–	9.60	0.3780	43.0	89.0	9.60
A0229.7	–	9.70	0.3819	43.0	89.0	9.70
A0229.8	–	9.80	0.3858	43.0	89.0	9.80
A0229.9	–	9.90	0.3898	43.0	89.0	9.90
A02210.0	–	10.00	0.3937	43.0	89.0	10.00
A02210.1	–	10.10	0.3976	43.0	89.0	10.10
A02210.2	–	10.20	0.4016	43.0	89.0	10.20
A02210.3	–	10.30	0.4055	43.0	89.0	10.30
A02213/32	13/32	10.32	0.4063	51.0	86.0	10.32
A02210.4	–	10.40	0.4094	43.0	89.0	10.40
A02210.5	–	10.50	0.4134	43.0	89.0	10.50
A02210.6	–	10.60	0.4173	43.0	89.0	10.60
A02210.7	–	10.70	0.4213	47.0	95.0	10.70
A02210.8	–	10.80	0.4252	47.0	95.0	10.80
A02210.9	–	10.90	0.4291	47.0	95.0	10.90
A02211.0	–	11.00	0.4331	47.0	95.0	11.00
A02211.1	–	11.10	0.4370	47.0	95.0	11.10
A0227/16	7/16	11.11	0.4375	54.0	89.0	11.11
A02211.2	–	11.20	0.4409	47.0	95.0	11.20
A02211.3	–	11.30	0.4449	47.0	95.0	11.30
A02211.5	–	11.50	0.4528	47.0	95.0	11.50
A02211.6	–	11.60	0.4567	47.0	95.0	11.60
A02211.7	–	11.70	0.4606	47.0	95.0	11.70
A02211.8	–	11.80	0.4646	47.0	95.0	11.80
A02211.9	–	11.90	0.4685	51.0	102.0	11.90
A02212.0	–	12.00	0.4724	51.0	102.0	12.00
A02212.1	–	12.10	0.4764	51.0	102.0	12.10
A02212.2	–	12.20	0.4803	51.0	102.0	12.20
A02212.5	–	12.50	0.4921	51.0	102.0	12.50
A0221/2	1/2	12.70	0.5000	60.0	98.0	12.70
A02213.0	–	13.00	0.5118	51.0	102.0	13.00
A02213.5	–	13.50	0.5315	54.0	107.0	13.50
A02214.0	–	14.00	0.5512	54.0	107.0	14.00
A0229/16	9/16	14.29	0.5625	67.0	105.0	14.29
A02214.5	–	14.50	0.5709	56.0	111.0	14.50
A02215.0	–	15.00	0.5906	56.0	111.0	15.00
A02215.5	–	15.50	0.6102	58.0	115.0	15.50
A0225/8	5/8	15.88	0.6250	73.0	111.0	15.88
A02216.0	–	16.00	0.6299	58.0	115.0	16.00



A002



HSS Jobber Drill, TiN-Tip Coated

Versatile drill for both hand-held and machine drilling. A specially designed 118° split point which helps to self-center the drill when drilling by hand and provides more accurate sized holes. Suitable for many materials. TiN-Tip coating improves performance and extends tool life.

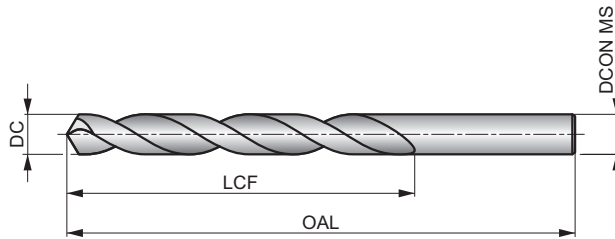

HSS	DIN 338	4xD
118°	TiN-Tip	
λ 20-35°	R	DC h8

Workpiece material group suitability, starting values for cutting speed (m/min) and feed Alpha Code. Tables with feed per revolution can be found starting from page 71.

P1.1 ■ 46 J	P1.2 ■ 52 J	P1.3 ■ 54 J	P2.1 ■ 40 J	P2.2 ■ 35 F	P2.3 ■ 31 F	P3.1 ■ 27 F	P3.2 ■ 21 F	P3.3 ■ 18 F	P4.1 ■ 16 F	P4.2 ■ 13 F	P4.3 ■ 11 E	M1.1 ■ 27 F	M1.2 ■ 23 F
M2.1 ■ 24 F	M2.2 ■ 20 F	M3.1 ■ 14 G	M3.2 ■ 12 G	M3.3 ■ 11 G	M4.1 ■ 16 C	K1.1 ■ 40 J	K1.2 ■ 30 E	K1.3 ■ 22 E	K2.1 ■ 34 E	K2.2 ■ 28 E	K2.3 ■ 22 E	K3.1 ■ 30 E	K3.2 ■ 23 E
K3.3 ■ 19 E	K4.1 ■ 28 E	K4.2 ■ 21 E	K4.3 ■ 16 E	K4.4 ■ 13 E	K4.5 ■ 11 E	K5.1 ■ 32 E	K5.2 ■ 24 E	K5.3 ■ 19 E	N1.1 ■ 41 K	N1.2 ■ 31 K	N1.3 ■ 21 J	N2.1 ■ 51 I	N2.2 ■ 46 I
N2.3 ■ 33 I	N3.1 ■ 56 H	N3.2 ■ 33 I	N3.3 ■ 17 G	N4.1 ■ 30 I	N4.2 ■ 50 H	N4.3 ■ 35 F	S1.1 ■ 23 F	S1.2 ■ 13 D	S1.3 ■ 7 B	S2.1 ■ 9 E	S2.2 ■ 4 A	S3.1 ■ 7 E	S3.2 ■ 3 A
S4.1 ■ 5 E	S4.2 ■ 2 A												

DC < 2mm Bright; DC >= 2mm TiN Tipped and Split Point.

Products from this series are also available in set. Please see A087, A089 A094, A095 or A099.

Product	DC (inch)	DC (mm)	DC (inch)	LCF (mm)	OAL (mm)	DCON MS (mm)
A0021.0	—	1.00	0.0394	12.0	34.0	1.00
A0021.1	—	1.10	0.0433	14.0	36.0	1.10
A0023/64	3/64	1.19	0.0469	16.0	38.0	1.19
A0021.2	—	1.20	0.0472	16.0	38.0	1.20
A0021.3	—	1.30	0.0512	16.0	38.0	1.30
A0021.4	—	1.40	0.0551	18.0	40.0	1.40
A0021.5	—	1.50	0.0591	18.0	40.0	1.50
A0021/16	1/16	1.59	0.0625	20.0	43.0	1.59
A0021.6	—	1.60	0.0630	20.0	43.0	1.60
A0021.7	—	1.70	0.0669	20.0	43.0	1.70
A0021.8	—	1.80	0.0709	22.0	46.0	1.80
A0021.9	—	1.90	0.0748	22.0	46.0	1.90
A0025/64	5/64	1.98	0.0781	24.0	49.0	1.98
A0022.0	—	2.00	0.0787	24.0	49.0	2.00
A0022.1	—	2.10	0.0827	24.0	49.0	2.10
A0022.2	—	2.20	0.0866	27.0	53.0	2.20
A0022.3	—	2.30	0.0906	27.0	53.0	2.30
A0023/32	3/32	2.38	0.0938	30.0	57.0	2.38
A0022.4	—	2.40	0.0945	30.0	57.0	2.40
A0022.5	—	2.50	0.0984	30.0	57.0	2.50
A0022.6	—	2.60	0.1024	30.0	57.0	2.60
A0022.7	—	2.70	0.1063	33.0	61.0	2.70
A0027/64	7/64	2.78	0.1094	33.0	61.0	2.78
A0022.8	—	2.80	0.1102	33.0	61.0	2.80

Product	DC (inch)	DC (mm)	DC (inch)	LCF (mm)	OAL (mm)	DCON MS (mm)
A0022.9	—	2.90	0.1142	33.0	61.0	2.90
A0023.0	—	3.00	0.1181	33.0	61.0	3.00
A0023.1	—	3.10	0.1220	36.0	65.0	3.10
A0021/8	1/8	3.18	0.1250	36.0	65.0	3.18
A0023.2	—	3.20	0.1260	36.0	65.0	3.20
A0023.25	—	3.25	0.1280	36.0	65.0	3.25
A0023.3	—	3.30	0.1299	36.0	65.0	3.30
A0023.4	—	3.40	0.1339	39.0	70.0	3.40
A0023.5	—	3.50	0.1378	39.0	70.0	3.50
A0029/64	9/64	3.57	0.1406	39.0	70.0	3.57
A0023.6	—	3.60	0.1417	39.0	70.0	3.60
A0023.7	—	3.70	0.1457	39.0	70.0	3.70
A0023.8	—	3.80	0.1496	43.0	75.0	3.80
A0023.9	—	3.90	0.1535	43.0	75.0	3.90
A0025/32	5/32	3.97	0.1563	43.0	75.0	3.97
A0024.0	—	4.00	0.1575	43.0	75.0	4.00
A0024.1	—	4.10	0.1614	43.0	75.0	4.10
A0024.2	—	4.20	0.1654	43.0	75.0	4.20
A0024.3	—	4.30	0.1693	47.0	80.0	4.30
A00211/64	11/64	4.37	0.1719	47.0	80.0	4.37
A0024.4	—	4.40	0.1732	47.0	80.0	4.40
A0024.5	—	4.50	0.1772	47.0	80.0	4.50
A0024.6	—	4.60	0.1811	47.0	80.0	4.60
A0024.7	—	4.70	0.1850	47.0	80.0	4.70



Product	DC	DC	DC	LCF	OAL	D CON MS
	(inch)	(mm)	(inch)	(mm)	(mm)	(mm)
A0023/16	3/16	4.76	0.1875	52.0	86.0	4.76
A0024.8	–	4.80	0.1890	52.0	86.0	4.80
A0024.9	–	4.90	0.1929	52.0	86.0	4.90
A0025.0	–	5.00	0.1969	52.0	86.0	5.00
A0025.1	–	5.10	0.2008	52.0	86.0	5.10
A00213/64	13/64	5.16	0.2031	52.0	86.0	5.16
A0025.2	–	5.20	0.2047	52.0	86.0	5.20
A0025.3	–	5.30	0.2087	52.0	86.0	5.30
A0025.4	–	5.40	0.2126	57.0	93.0	5.40
A0025.5	–	5.50	0.2165	57.0	93.0	5.50
A0027/32	7/32	5.56	0.2188	57.0	93.0	5.56
A0025.6	–	5.60	0.2205	57.0	93.0	5.60
A0025.7	–	5.70	0.2244	57.0	93.0	5.70
A0025.8	–	5.80	0.2283	57.0	93.0	5.80
A0025.9	–	5.90	0.2323	57.0	93.0	5.90
A00215/64	15/64	5.95	0.2344	57.0	93.0	5.95
A0026.0	–	6.00	0.2362	57.0	93.0	6.00
A0026.1	–	6.10	0.2402	63.0	101.0	6.10
A0026.2	–	6.20	0.2441	63.0	101.0	6.20
A0026.3	–	6.30	0.2480	63.0	101.0	6.30
A0021/4	1/4	6.35	0.2500	63.0	101.0	6.35
A0026.4	–	6.40	0.2520	63.0	101.0	6.40
A0026.5	–	6.50	0.2559	63.0	101.0	6.50
A0026.6	–	6.60	0.2598	63.0	101.0	6.60
A0026.7	–	6.70	0.2638	63.0	101.0	6.70
A00217/64	17/64	6.75	0.2656	69.0	109.0	6.75
A0026.8	–	6.80	0.2677	69.0	109.0	6.80
A0026.9	–	6.90	0.2717	69.0	109.0	6.90
A0027.0	–	7.00	0.2756	69.0	109.0	7.00
A0027.1	–	7.10	0.2795	69.0	109.0	7.10
A0029/32	9/32	7.14	0.2813	69.0	109.0	7.14
A0027.2	–	7.20	0.2835	69.0	109.0	7.20
A0027.3	–	7.30	0.2874	69.0	109.0	7.30
A0027.4	–	7.40	0.2913	69.0	109.0	7.40
A0027.5	–	7.50	0.2953	69.0	109.0	7.50
A00219/64	19/64	7.54	0.2969	75.0	117.0	7.54
A0027.6	–	7.60	0.2992	75.0	117.0	7.60
A0027.7	–	7.70	0.3031	75.0	117.0	7.70
A0027.8	–	7.80	0.3071	75.0	117.0	7.80
A0027.9	–	7.90	0.3110	75.0	117.0	7.90
A0025/16	5/16	7.94	0.3125	75.0	117.0	7.94
A0028.0	–	8.00	0.3150	75.0	117.0	8.00
A0028.1	–	8.10	0.3189	75.0	117.0	8.10
A0028.2	–	8.20	0.3228	75.0	117.0	8.20
A0028.3	–	8.30	0.3268	75.0	117.0	8.30
A00221/64	21/64	8.33	0.3281	75.0	117.0	8.33
A0028.4	–	8.40	0.3307	75.0	117.0	8.40
A0028.5	–	8.50	0.3346	75.0	117.0	8.50
A0028.6	–	8.60	0.3386	81.0	125.0	8.60
A0028.7	–	8.70	0.3425	81.0	125.0	8.70
A00211/32	11/32	8.73	0.3438	81.0	125.0	8.73
A0028.8	–	8.80	0.3465	81.0	125.0	8.80
A0028.9	–	8.90	0.3504	81.0	125.0	8.90
A0029.0	–	9.00	0.3543	81.0	125.0	9.00
A0029.1	–	9.10	0.3583	81.0	125.0	9.10
A00223/64	23/64	9.13	0.3594	81.0	125.0	9.13
A0029.2	–	9.20	0.3622	81.0	125.0	9.20
A0029.3	–	9.30	0.3661	81.0	125.0	9.30
A0029.4	–	9.40	0.3701	81.0	125.0	9.40
A0029.5	–	9.50	0.3740	81.0	125.0	9.50
A0023/8	3/8	9.52	0.3750	87.0	133.0	9.52
A0029.6	–	9.60	0.3780	87.0	133.0	9.60
A0029.7	–	9.70	0.3819	87.0	133.0	9.70
A0029.8	–	9.80	0.3858	87.0	133.0	9.80
A0029.9	–	9.90	0.3898	87.0	133.0	9.90
A00225/64	25/64	9.92	0.3906	87.0	133.0	9.92
A00210.0	–	10.00	0.3937	87.0	133.0	10.00

Product	DC	DC	DC	LCF	OAL	D CON MS
	(inch)	(mm)	(inch)	(mm)	(mm)	(mm)
A00210.1	–	10.10	0.3976	87.0	133.0	10.10
A00210.2	–	10.20	0.4016	87.0	133.0	10.20
A00210.3	–	10.30	0.4055	87.0	133.0	10.30
A00213/32	13/32	10.32	0.4063	87.0	133.0	10.32
A00210.4	–	10.40	0.4094	87.0	133.0	10.40
A00210.5	–	10.50	0.4134	87.0	133.0	10.50
A00210.6	–	10.60	0.4173	87.0	133.0	10.60
A00210.7	–	10.70	0.4213	94.0	142.0	10.70
A00227/64	27/64	10.72	0.4219	94.0	142.0	10.72
A00210.8	–	10.80	0.4252	94.0	142.0	10.80
A00210.9	–	10.90	0.4291	94.0	142.0	10.90
A00211.0	–	11.00	0.4331	94.0	142.0	11.00
A00211.1	–	11.10	0.4370	94.0	142.0	11.10
A0027/16	7/16	11.11	0.4375	94.0	142.0	11.11
A00211.2	–	11.20	0.4409	94.0	142.0	11.20
A00211.3	–	11.30	0.4449	94.0	142.0	11.30
A00211.4	–	11.40	0.4488	94.0	142.0	11.40
A00211.5	–	11.50	0.4528	94.0	142.0	11.50
A00229/64	29/64	11.51	0.4531	94.0	142.0	11.51
A00211.6	–	11.60	0.4567	94.0	142.0	11.60
A00211.7	–	11.70	0.4606	94.0	142.0	11.70
A00211.8	–	11.80	0.4646	94.0	142.0	11.80
A00211.9	–	11.90	0.4685	101.0	151.0	11.90
A00215/32	15/32	11.91	0.4688	101.0	151.0	11.91
A00212.0	–	12.00	0.4724	101.0	151.0	12.00
A00212.1	–	12.10	0.4764	101.0	151.0	12.10
A00212.2	–	12.20	0.4803	101.0	151.0	12.20
A00212.3	–	12.30	0.4843	101.0	151.0	12.30
A00231/64	31/64	12.30	0.4844	101.0	151.0	12.30
A00212.4	–	12.40	0.4882	101.0	151.0	12.40
A00212.5	–	12.50	0.4921	101.0	151.0	12.50
A00212.6	–	12.60	0.4961	101.0	151.0	12.60
A00212.7	–	12.70	0.5000	101.0	151.0	12.70
A0021/2	1/2	12.70	0.5000	101.0	151.0	12.70
A00212.8	–	12.80	0.5039	101.0	151.0	12.80
A00212.9	–	12.90	0.5079	101.0	151.0	12.90
A00213.0	–	13.00	0.5118	101.0	151.0	13.00
A00233/64	33/64	13.10	0.5156	101.0	151.0	13.10
A00213.1	–	13.10	0.5157	101.0	151.0	13.10
A00213.2	–	13.20	0.5197	101.0	151.0	13.20
A00213.25	–	13.25	0.5217	108.0	160.0	13.25
A00213.3	–	13.30	0.5236	108.0	160.0	13.30
A00213.4	–	13.40	0.5276	108.0	160.0	13.40
A00217/32	17/32	13.49	0.5313	108.0	160.0	13.49
A00213.5	–	13.50	0.5315	108.0	160.0	13.50
A00213.6	–	13.60	0.5354	108.0	160.0	13.60
A00213.7	–	13.70	0.5394	108.0	160.0	13.70
A00213.75	–	13.75	0.5413	108.0	160.0	13.75
A00213.8	–	13.80	0.5433	108.0	160.0	13.80
A00235/64	35/64	13.89	0.5469	108.0	160.0	13.89
A00213.9	–	13.90	0.5472	108.0	160.0	13.90
A00214.0	–	14.00	0.5512	108.0	160.0	14.00
A00214.25	–	14.25	0.5610	114.0	169.0	14.25
A0029/16	9/16	14.29	0.5625	114.0	169.0	14.29
A00214.5	–	14.50	0.5709	114.0	169.0	14.50
A00237/64	37/64	14.68	0.5781	114.0	169.0	14.68
A00214.75	–	14.75	0.5807	114.0	169.0	14.75
A00215.0	–	15.00	0.5906	114.0	169.0	15.00
A00219/32	19/32	15.08	0.5938	120.0	178.0	15.08
A00215.25	–	15.25	0.6004	120.0	178.0	15.25
A00239/64	39/64	15.48	0.6094	120.0	178.0	15.48
A00215.5	–	15.50	0.6102	120.0	178.0	15.50
A00215.75	–	15.75	0.6201	120.0	178.0	15.75
A0025/8	5/8	15.88	0.6250	120.0	178.0	15.88
A00216.0	–	16.00	0.6299	120.0	178.0	16.00

A002S



HSS Jobber Drill, TiN-Tip Coated

Versatile drill for both hand-held and machine drilling. A specially designed 118° split point which helps to self-center the drill when drilling by hand and provides more accurate sized hole. Suitable for many materials. TiN-Tip coating improves performance and extends tool life.

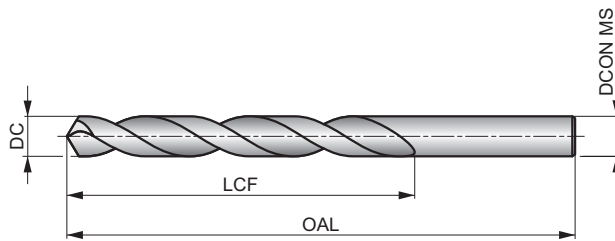

HSS	DIN 338	4xD
118°	TiN-Tip	
λ 20-35°	R	DC h8

Workpiece material group suitability, starting values for cutting speed (m/min) and feed Alpha Code. Tables with feed per revolution can be found starting from page 71.

P1.1 ■ 46 J	P1.2 ■ 52 J	P1.3 ■ 54 J	P2.1 ■ 40 J	P2.2 ■ 35 F	P2.3 ■ 31 F	P3.1 ■ 27 F	P3.2 ■ 21 F	P3.3 ■ 18 F	P4.1 ■ 16 F	P4.2 ■ 13 F	P4.3 ■ 11 E	M1.1 ■ 27 F	M1.2 ■ 23 F
M2.1 ■ 24 F	M2.2 ■ 20 F	M3.1 ■ 14 G	M3.2 ■ 12 G	M3.3 ■ 11 G	M4.1 ■ 16 C	K1.1 ■ 40 J	K1.2 ■ 30 E	K1.3 ■ 22 E	K2.1 ■ 34 E	K2.2 ■ 28 E	K2.3 ■ 22 E	K3.1 ■ 30 E	K3.2 ■ 23 E
K3.3 ■ 19 E	K4.1 ■ 28 E	K4.2 ■ 21 E	K4.3 ■ 16 E	K4.4 ■ 13 E	K4.5 ■ 11 E	K5.1 ■ 32 E	K5.2 ■ 24 E	K5.3 ■ 19 E	N1.1 ■ 41 K	N1.2 ■ 31 K	N1.3 ■ 21 J	N2.1 ■ 51 I	N2.2 ■ 46 I
N2.3 ■ 33 I	N3.1 ■ 56 H	N3.2 ■ 33 I	N3.3 ■ 17 G	N4.1 ■ 30 I	N4.2 ■ 50 H	N4.3 ■ 35 F	S1.1 ■ 23 F	S1.2 ■ 13 D	S1.3 ■ 7 B	S2.1 ■ 9 E	S2.2 ■ 4 A	S3.1 ■ 7 E	S3.2 ■ 3 A
S4.1 ■ 5 E	S4.2 ■ 2 A												

DC <= 5mm Sold in packs of 2.

Product	DC (inch)	DC (mm)	DC (inch)	LCF (mm)	OAL (mm)	DCON MS (mm)
A002S2.0	-	2.00	0.0787	24.0	49.0	2.00
A002S2.5	-	2.50	0.0984	30.0	57.0	2.50
A002S3.0	-	3.00	0.1181	33.0	61.0	3.00
A002S1/8	1/8	3.18	0.1250	36.0	65.0	3.18
A002S3.2	-	3.20	0.1260	36.0	65.0	3.20
A002S3.3	-	3.30	0.1299	36.0	65.0	3.30
A002S3.5	-	3.50	0.1378	39.0	70.0	3.50
A002S5/32	5/32	3.97	0.1563	43.0	75.0	3.97
A002S4.0	-	4.00	0.1575	43.0	75.0	4.00
A002S4.1	-	4.10	0.1614	43.0	75.0	4.10
A002S4.2	-	4.20	0.1654	43.0	75.0	4.20
A002S4.5	-	4.50	0.1772	47.0	80.0	4.50
A002S3/16	3/16	4.76	0.1875	52.0	86.0	4.76
A002S5.0	-	5.00	0.1969	52.0	86.0	5.00
A002S13/64	13/64	5.16	0.2031	52.0	86.0	5.16
A002S5.5	-	5.50	0.2165	57.0	93.0	5.50
A002S7/32	7/32	5.56	0.2188	57.0	93.0	5.56
A002S6.0	-	6.00	0.2362	57.0	93.0	6.00
A002S1/4	1/4	6.35	0.2500	63.0	101.0	6.35
A002S6.5	-	6.50	0.2559	63.0	101.0	6.50

Product	DC (inch)	DC (mm)	DC (inch)	LCF (mm)	OAL (mm)	DCON MS (mm)
A002S17/64	17/64	6.75	0.2656	69.0	109.0	6.75
A002S6.8	-	6.80	0.2677	69.0	109.0	6.80
A002S7.0	-	7.00	0.2756	69.0	109.0	7.00
A002S7.5	-	7.50	0.2953	69.0	109.0	7.50
A002S5/16	5/16	7.94	0.3125	75.0	117.0	7.94
A002S8.0	-	8.00	0.3150	75.0	117.0	8.00
A002S8.2	-	8.20	0.3228	75.0	117.0	8.20
A002S8.5	-	8.50	0.3346	75.0	117.0	8.50
A002S9.0	-	9.00	0.3543	81.0	125.0	9.00
A002S9.5	-	9.50	0.3740	81.0	125.0	9.50
A002S3/8	3/8	9.52	0.3750	87.0	133.0	9.52
A002S10.0	-	10.00	0.3937	87.0	133.0	10.00
A002S10.2	-	10.20	0.4016	87.0	133.0	10.20
A002S10.5	-	10.50	0.4134	87.0	133.0	10.50
A002S11.0	-	11.00	0.4331	94.0	142.0	11.00
A002S11.5	-	11.50	0.4528	94.0	142.0	11.50
A002S12.0	-	12.00	0.4724	101.0	151.0	12.00
A002S12.5	-	12.50	0.4921	101.0	151.0	12.50
A002S1/2	1/2	12.70	0.5000	101.0	151.0	12.70
A002S13.0	-	13.00	0.5118	101.0	151.0	13.00

A108



HSS Jobber Drill, Steam Tempered Finish (Designed for Stainless Steel)

First choice when drilling stainless steel with hand-held applications, but can also be used effectively in machines. The 135° split point helps to self-center and reduces the cutting forces. Steam tempered finish helps stop workpiece material from sticking to the cutting edge.

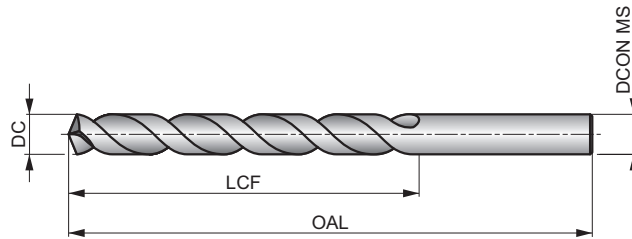

HSS	DIN 338	4×D
135°	ST	
λ>35°	R	DC h8

Workpiece material group suitability, starting values for cutting speed (m/min) and feed Alpha Code. Tables with feed per revolution can be found starting from page 71.

P1.1 □33 I	P1.2 □37 I	P1.3 □38 I	P2.1 □28 I	P2.2 □25 G	P2.3 □22 E	P3.1 □19 F	P3.2 □15 F	P3.3 □13 E	P4.1 □11 F	P4.2 □10 E	P4.3 □8 D	M1.1 □21 E	M1.2 □17 E
M2.1 □18 E	M2.2 □15 E	M3.1 ■10 G	M3.2 ■9 G	M3.3 ■8 G	M4.1 ■10 D	K1.1 □30 H	K1.2 □22 F	K1.3 □17 F	K2.1 □25 E	K2.2 □20 E	K2.3 □16 E	K3.1 □22 E	K3.2 □17 E
K3.3 □13 E	K4.1 □20 E	K4.2 □15 E	K4.3 □11 E	K4.4 □10 E	K4.5 □8 E	K5.1 □23 E	K5.2 □17 E	K5.3 □13 E	N1.1 □33 J	N1.2 □25 J	N1.3 □17 I	N2.1 □42 H	N2.2 □37 H
N2.3 □27 H	N3.1 □59 H	N3.2 □35 I	N3.3 □18 G	N4.1 □30 J	N4.2 □28 H	N4.3 □14 F	S1.1 ■25 G	S1.2 ■16 E	S1.3 □7 B	S2.1 □9 G	S2.2 □8 E	S3.1 □7 G	S3.2 □6 E
S4.1 □5 G	S4.2 □5 E												

DC > 1.5mm (1/16") Split Point.

Products from this series are also available in set. Please see A188.

Product	DC	DC	DC	LCF	OAL	DCON MS	Product	DC	DC	DC	LCF	OAL	DCON MS
	(inch)	(mm)	(inch)	(mm)	(mm)	(mm)		(inch)	(mm)	(inch)	(mm)	(mm)	(mm)
A1081.0	–	1.00	0.0394	12.0	34.0	1.00	A1082.8	–	2.80	0.1102	33.0	61.0	2.80
A1081.1	–	1.10	0.0433	14.0	36.0	1.10	A1082.9	–	2.90	0.1142	33.0	61.0	2.90
A1081.2	–	1.20	0.0472	16.0	38.0	1.20	A1083.0	–	3.00	0.1181	33.0	61.0	3.00
A1081.3	–	1.30	0.0512	16.0	38.0	1.30	A1083.1	–	3.10	0.1220	36.0	65.0	3.10
A1081.4	–	1.40	0.0551	18.0	40.0	1.40	A1081/8	1/8	3.18	0.1250	36.0	65.0	3.18
A1081.5	–	1.50	0.0591	18.0	40.0	1.50	A1083.2	–	3.20	0.1260	36.0	65.0	3.20
A1081/16	1/16	1.59	0.0625	20.0	43.0	1.59	A1083.3	–	3.30	0.1299	36.0	65.0	3.30
A1081.6	–	1.60	0.0630	20.0	43.0	1.60	A1083.4	–	3.40	0.1339	39.0	70.0	3.40
A1081.7	–	1.70	0.0669	20.0	43.0	1.70	A1083.5	–	3.50	0.1378	39.0	70.0	3.50
A1081.8	–	1.80	0.0709	22.0	46.0	1.80	A1089/64	9/64	3.57	0.1406	39.0	70.0	3.57
A1081.9	–	1.90	0.0748	22.0	46.0	1.90	A1083.6	–	3.60	0.1417	39.0	70.0	3.60
A1085/64	5/64	1.98	0.0781	24.0	49.0	1.98	A1083.7	–	3.70	0.1457	39.0	70.0	3.70
A1082.0	–	2.00	0.0787	24.0	49.0	2.00	A1083.8	–	3.80	0.1496	43.0	75.0	3.80
A1082.1	–	2.10	0.0827	24.0	49.0	2.10	A1083.9	–	3.90	0.1535	43.0	75.0	3.90
A1082.2	–	2.20	0.0866	27.0	53.0	2.20	A1085/32	5/32	3.97	0.1563	43.0	75.0	3.97
A1082.3	–	2.30	0.0906	27.0	53.0	2.30	A1084.0	–	4.00	0.1575	43.0	75.0	4.00
A1083/32	3/32	2.38	0.0938	30.0	57.0	2.38	A1084.1	–	4.10	0.1614	43.0	75.0	4.10
A1082.4	–	2.40	0.0945	30.0	57.0	2.40	A1084.2	–	4.20	0.1654	43.0	75.0	4.20
A1082.5	–	2.50	0.0984	30.0	57.0	2.50	A1084.3	–	4.30	0.1693	47.0	80.0	4.30
A1082.6	–	2.60	0.1024	30.0	57.0	2.60	A10811/64	11/64	4.37	0.1719	47.0	80.0	4.37
A1082.7	–	2.70	0.1063	33.0	61.0	2.70	A1084.4	–	4.40	0.1732	47.0	80.0	4.40
A1087/64	7/64	2.78	0.1094	33.0	61.0	2.78	A1084.5	–	4.50	0.1772	47.0	80.0	4.50



Product	DC	DC	DC	LCF	OAL	D CON MS
	(inch)	(mm)	(inch)	(mm)	(mm)	(mm)
A1084.6	—	4.60	0.1811	47.0	80.0	4.60
A1084.7	—	4.70	0.1850	47.0	80.0	4.70
A1083/16	3/16	4.76	0.1875	52.0	86.0	4.76
A1084.8	—	4.80	0.1890	52.0	86.0	4.80
A1084.9	—	4.90	0.1929	52.0	86.0	4.90
A108N10	N10	4.92	0.1935	52.0	86.0	4.92
A1085.0	—	5.00	0.1969	52.0	86.0	5.00
A1085.1	—	5.10	0.2008	52.0	86.0	5.10
A10813/64	13/64	5.16	0.2031	52.0	86.0	5.16
A1085.2	—	5.20	0.2047	52.0	86.0	5.20
A1085.3	—	5.30	0.2087	52.0	86.0	5.30
A1085.4	—	5.40	0.2126	57.0	93.0	5.40
A1085.5	—	5.50	0.2165	57.0	93.0	5.50
A1087/32	7/32	5.56	0.2188	57.0	93.0	5.56
A1085.6	—	5.60	0.2205	57.0	93.0	5.60
A1085.7	—	5.70	0.2244	57.0	93.0	5.70
A1085.8	—	5.80	0.2283	57.0	93.0	5.80
A1085.9	—	5.90	0.2323	57.0	93.0	5.90
A10815/64	15/64	5.95	0.2344	57.0	93.0	5.95
A1086.0	—	6.00	0.2362	57.0	93.0	6.00
A1086.1	—	6.10	0.2402	63.0	101.0	6.10
A1086.2	—	6.20	0.2441	63.0	101.0	6.20
A1086.3	—	6.30	0.2480	63.0	101.0	6.30
A1081/4	1/4	6.35	0.2500	63.0	101.0	6.35
A1086.4	—	6.40	0.2520	63.0	101.0	6.40
A1086.5	—	6.50	0.2559	63.0	101.0	6.50
A1086.6	—	6.60	0.2598	63.0	101.0	6.60
A1086.7	—	6.70	0.2638	63.0	101.0	6.70
A10817/64	17/64	6.75	0.2656	69.0	109.0	6.75
A1086.8	—	6.80	0.2677	69.0	109.0	6.80
A1086.9	—	6.90	0.2717	69.0	109.0	6.90
A1087.0	—	7.00	0.2756	69.0	109.0	7.00
A1087.1	—	7.10	0.2795	69.0	109.0	7.10
A1089/32	9/32	7.14	0.2813	69.0	109.0	7.14
A1087.2	—	7.20	0.2835	69.0	109.0	7.20
A1087.3	—	7.30	0.2874	69.0	109.0	7.30
A1087.4	—	7.40	0.2913	69.0	109.0	7.40
A1087.5	—	7.50	0.2953	69.0	109.0	7.50
A10819/64	19/64	7.54	0.2969	75.0	117.0	7.54
A1087.6	—	7.60	0.2992	75.0	117.0	7.60
A1087.7	—	7.70	0.3031	75.0	117.0	7.70
A1087.8	—	7.80	0.3071	75.0	117.0	7.80
A1087.9	—	7.90	0.3110	75.0	117.0	7.90
A1085/16	5/16	7.94	0.3125	75.0	117.0	7.94
A1088.0	—	8.00	0.3150	75.0	117.0	8.00
A1088.1	—	8.10	0.3189	75.0	117.0	8.10
A1088.2	—	8.20	0.3228	75.0	117.0	8.20
A1088.3	—	8.30	0.3268	75.0	117.0	8.30

Product	DC	DC	DC	LCF	OAL	D CON MS
	(inch)	(mm)	(inch)	(mm)	(mm)	(mm)
A10821/64	21/64	8.33	0.3281	75.0	117.0	8.33
A1088.4	—	8.40	0.3307	75.0	117.0	8.40
A1088.5	—	8.50	0.3346	75.0	117.0	8.50
A1088.6	—	8.60	0.3386	81.0	125.0	8.60
A1088.7	—	8.70	0.3425	81.0	125.0	8.70
A10811/32	11/32	8.73	0.3438	81.0	125.0	8.73
A1088.8	—	8.80	0.3465	81.0	125.0	8.80
A1088.9	—	8.90	0.3504	81.0	125.0	8.90
A1089.0	—	9.00	0.3543	81.0	125.0	9.00
A1089.1	—	9.10	0.3583	81.0	125.0	9.10
A10823/64	23/64	9.13	0.3594	81.0	125.0	9.13
A1089.2	—	9.20	0.3622	81.0	125.0	9.20
A1089.3	—	9.30	0.3661	81.0	125.0	9.30
A1089.4	—	9.40	0.3701	81.0	125.0	9.40
A1089.5	—	9.50	0.3740	81.0	125.0	9.50
A1083/8	3/8	9.52	0.3750	87.0	133.0	9.52
A1089.6	—	9.60	0.3780	87.0	133.0	9.60
A1089.7	—	9.70	0.3819	87.0	133.0	9.70
A1089.8	—	9.80	0.3858	87.0	133.0	9.80
A1089.9	—	9.90	0.3898	87.0	133.0	9.90
A10825/64	25/64	9.92	0.3906	87.0	133.0	9.92
A10810.0	—	10.00	0.3937	87.0	133.0	10.00
A10810.2	—	10.20	0.4016	87.0	133.0	10.20
A10813/32	13/32	10.32	0.4063	87.0	133.0	10.32
A10810.5	—	10.50	0.4134	87.0	133.0	10.50
A10827/64	27/64	10.72	0.4219	94.0	142.0	10.72
A10810.8	—	10.80	0.4252	94.0	142.0	10.80
A10811.0	—	11.00	0.4331	94.0	142.0	11.00
A1087/16	7/16	11.11	0.4375	94.0	142.0	11.11
A10811.5	—	11.50	0.4528	94.0	142.0	11.50
A10829/64	29/64	11.51	0.4531	94.0	142.0	11.51
A10811.8	—	11.80	0.4646	94.0	142.0	11.80
A10815/32	15/32	11.91	0.4688	101.0	151.0	11.91
A10812.0	—	12.00	0.4724	101.0	151.0	12.00
A10812.2	—	12.20	0.4803	101.0	151.0	12.20
A10831/64	31/64	12.30	0.4844	101.0	151.0	12.30
A10812.5	—	12.50	0.4921	101.0	151.0	12.50
A1081/2	1/2	12.70	0.5000	101.0	151.0	12.70
A10812.8	—	12.80	0.5039	101.0	151.0	12.80
A10812.9	—	12.90	0.5079	101.0	151.0	12.90
A10813.0	—	13.00	0.5118	101.0	151.0	13.00
A10813.5	—	13.50	0.5315	108.0	160.0	13.50
A10814.0	—	14.00	0.5512	108.0	160.0	14.00
A10814.5	—	14.50	0.5709	114.0	169.0	14.50
A10815.0	—	15.00	0.5906	114.0	169.0	15.00
A10815.25	—	15.25	0.6004	120.0	178.0	15.25
A10815.5	—	15.50	0.6102	120.0	178.0	15.50
A10816.0	—	16.00	0.6299	120.0	178.0	16.00

A117



HSS-E (8% Cobalt) Stub Drill, Bronze Tempered Finish

Drill recommended for use in difficult materials and applications. A 135° split point makes self-centering easier and also reduces the cutting forces. Can be relied on to produce a precise hole and quality finish. The bronze finish is a thin oxide layer and it is an indication for Cobalt.

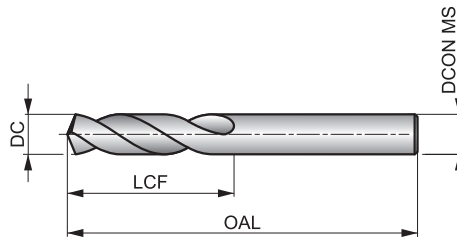

HSS-E	DIN 1897	2.5×D
135°	Bronze	
λ _{20-35°}	R	DC h8

Workpiece material group suitability, starting values for cutting speed (m/min) and feed Alpha Code. Tables with feed per revolution can be found starting from page 71.

P1.1 ■ 40 H	P1.2 ■ 45 H	P1.3 ■ 46 H	P2.1 ■ 34 H	P2.2 ■ 30 G	P2.3 ■ 27 F	P3.1 ■ 27 G	P3.2 ■ 21 G	P3.3 ■ 18 F	P4.1 ■ 16 G	P4.2 ■ 13 F	P4.3 ■ 11 E	M1.1 ■ 30 F	M1.2 ■ 26 F
M2.1 ■ 27 F	M2.2 ■ 22 F	M3.1 ■ 13 H	M3.2 ■ 11 H	M3.3 ■ 10 H	M4.1 ■ 15 D	K1.1 ■ 34 K	K1.2 ■ 25 F	K1.3 ■ 19 F	K2.1 ■ 27 F	K2.2 ■ 22 F	K2.3 ■ 18 F	K3.1 ■ 24 F	K3.2 ■ 18 F
K3.3 ■ 15 F	K4.1 ■ 22 F	K4.2 ■ 17 F	K4.3 ■ 12 F	K4.4 ■ 11 F	K4.5 ■ 9 F	K5.1 ■ 25 F	K5.2 ■ 19 F	K5.3 ■ 15 F	N1.1 ■ 35 K	N1.2 ■ 26 K	N1.3 ■ 18 J	N2.1 ■ 48 I	N2.2 ■ 43 I
N2.3 ■ 31 I	N3.1 ■ 68 J	N3.2 ■ 40 K	N3.3 ■ 20 I	N4.1 ■ 35 M	N4.2 ■ 28 K	N4.3 ■ 17 I	S1.1 ■ 30 G	S1.2 ■ 18 F	S1.3 ■ 10 C	S2.1 ■ 12 F	S2.2 ■ 8 C	S3.1 ■ 9 F	S3.2 ■ 6 C
S4.1 ■ 7 F	S4.2 ■ 5 C												

DC ≤ 1.5mm 118° point; DC < 3.00mm 5% cobalt.

Product	DC (inch)	DC (mm)	DC (inch)	LCF (mm)	OAL (mm)	DCON MS (mm)	Product	DC (inch)	DC (mm)	DC (inch)	LCF (mm)	OAL (mm)	DCON MS (mm)
A1171.0	–	1.00	0.0394	6.0	26.0	1.00	A1173.2	–	3.20	0.1260	18.0	49.0	3.20
A1171.1	–	1.10	0.0433	7.0	28.0	1.10	A1173.3	–	3.30	0.1299	18.0	49.0	3.30
A1171.2	–	1.20	0.0472	8.0	30.0	1.20	A1173.4	–	3.40	0.1339	20.0	52.0	3.40
A1171.3	–	1.30	0.0512	8.0	30.0	1.30	A1173.5	–	3.50	0.1378	20.0	52.0	3.50
A1171.4	–	1.40	0.0551	9.0	32.0	1.40	A1173.6	–	3.60	0.1417	20.0	52.0	3.60
A1171.5	–	1.50	0.0591	9.0	32.0	1.50	A1173.7	–	3.70	0.1457	20.0	52.0	3.70
A1171.6	–	1.60	0.0630	10.0	34.0	1.60	A1173.8	–	3.80	0.1496	22.0	55.0	3.80
A1171.7	–	1.70	0.0669	10.0	34.0	1.70	A1173.9	–	3.90	0.1535	22.0	55.0	3.90
A1171.8	–	1.80	0.0709	11.0	36.0	1.80	A1175/32	5/32	3.97	0.1563	22.0	55.0	3.97
A1171.9	–	1.90	0.0748	11.0	36.0	1.90	A1174.0	–	4.00	0.1575	22.0	55.0	4.00
A1172.0	–	2.00	0.0787	12.0	38.0	2.00	A1174.1	–	4.10	0.1614	22.0	55.0	4.10
A1172.1	–	2.10	0.0827	12.0	38.0	2.10	A1174.2	–	4.20	0.1654	22.0	55.0	4.20
A1172.2	–	2.20	0.0866	13.0	40.0	2.20	A1174.3	–	4.30	0.1693	24.0	58.0	4.30
A1172.3	–	2.30	0.0906	13.0	40.0	2.30	A1174.4	–	4.40	0.1732	24.0	58.0	4.40
A1172.4	–	2.40	0.0945	14.0	43.0	2.40	A1174.5	–	4.50	0.1772	24.0	58.0	4.50
A1172.5	–	2.50	0.0984	14.0	43.0	2.50	A1174.6	–	4.60	0.1811	24.0	58.0	4.60
A1172.6	–	2.60	0.1024	14.0	43.0	2.60	A1174.7	–	4.70	0.1850	24.0	58.0	4.70
A1172.7	–	2.70	0.1063	16.0	46.0	2.70	A1173/16	3/16	4.76	0.1875	26.0	62.0	4.76
A1172.8	–	2.80	0.1102	16.0	46.0	2.80	A1174.8	–	4.80	0.1890	26.0	62.0	4.80
A1172.9	–	2.90	0.1142	16.0	46.0	2.90	A1174.9	–	4.90	0.1929	26.0	62.0	4.90
A1173.0	–	3.00	0.1181	16.0	46.0	3.00	A1175.0	–	5.00	0.1969	26.0	62.0	5.00
A1173.1	–	3.10	0.1220	18.0	49.0	3.10	A1175.1	–	5.10	0.2008	26.0	62.0	5.10
A1171/8	1/8	3.18	0.1250	18.0	49.0	3.18	A1175.2	–	5.20	0.2047	26.0	62.0	5.20



Product	DC	DC	DC	LCF	OAL	DCON MS
	(inch)	(mm)	(inch)	(mm)	(mm)	(mm)
A1175.3	–	5.30	0.2087	26.0	62.0	5.30
A1175.4	–	5.40	0.2126	28.0	66.0	5.40
A1175.5	–	5.50	0.2165	28.0	66.0	5.50
A1175.6	–	5.60	0.2205	28.0	66.0	5.60
A1175.7	–	5.70	0.2244	28.0	66.0	5.70
A1175.8	–	5.80	0.2283	28.0	66.0	5.80
A1175.9	–	5.90	0.2323	28.0	66.0	5.90
A1176.0	–	6.00	0.2362	28.0	66.0	6.00
A1176.1	–	6.10	0.2402	31.0	70.0	6.10
A1176.2	–	6.20	0.2441	31.0	70.0	6.20
A1176.3	–	6.30	0.2480	31.0	70.0	6.30
A1171/4	1/4	6.35	0.2500	31.0	70.0	6.35
A1176.4	–	6.40	0.2520	31.0	70.0	6.40
A1176.5	–	6.50	0.2559	31.0	70.0	6.50
A1176.6	–	6.60	0.2598	31.0	70.0	6.60
A1176.7	–	6.70	0.2638	31.0	70.0	6.70
A1176.8	–	6.80	0.2677	34.0	74.0	6.80
A1176.9	–	6.90	0.2717	34.0	74.0	6.90
A1177.0	–	7.00	0.2756	34.0	74.0	7.00
A1177.1	–	7.10	0.2795	34.0	74.0	7.10
A1177.2	–	7.20	0.2835	34.0	74.0	7.20
A1177.3	–	7.30	0.2874	34.0	74.0	7.30
A1177.4	–	7.40	0.2913	34.0	74.0	7.40
A1177.5	–	7.50	0.2953	34.0	74.0	7.50
A1177.6	–	7.60	0.2992	37.0	79.0	7.60
A1177.7	–	7.70	0.3031	37.0	79.0	7.70
A1177.8	–	7.80	0.3071	37.0	79.0	7.80
A1177.9	–	7.90	0.3110	37.0	79.0	7.90
A1175/16	5/16	7.94	0.3125	37.0	79.0	7.94

Product	DC	DC	DC	LCF	OAL	DCON MS
	(inch)	(mm)	(inch)	(mm)	(mm)	(mm)
A1178.0	–	8.00	0.3150	37.0	79.0	8.00
A1178.1	–	8.10	0.3189	37.0	79.0	8.10
A1178.2	–	8.20	0.3228	37.0	79.0	8.20
A1178.3	–	8.30	0.3268	37.0	79.0	8.30
A1178.4	–	8.40	0.3307	37.0	79.0	8.40
A1178.5	–	8.50	0.3346	37.0	79.0	8.50
A1178.6	–	8.60	0.3386	40.0	84.0	8.60
A1178.7	–	8.70	0.3425	40.0	84.0	8.70
A1178.8	–	8.80	0.3465	40.0	84.0	8.80
A1178.9	–	8.90	0.3504	40.0	84.0	8.90
A1179.0	–	9.00	0.3543	40.0	84.0	9.00
A1179.1	–	9.10	0.3583	40.0	84.0	9.10
A1179.2	–	9.20	0.3622	40.0	84.0	9.20
A1179.3	–	9.30	0.3661	40.0	84.0	9.30
A1179.4	–	9.40	0.3701	40.0	84.0	9.40
A1179.5	–	9.50	0.3740	40.0	84.0	9.50
A1173/8	3/8	9.52	0.3750	43.0	89.0	9.52
A1179.6	–	9.60	0.3780	43.0	89.0	9.60
A1179.7	–	9.70	0.3819	43.0	89.0	9.70
A1179.8	–	9.80	0.3858	43.0	89.0	9.80
A1179.9	–	9.90	0.3898	43.0	89.0	9.90
A11710.0	–	10.00	0.3937	43.0	89.0	10.00
A11710.2	–	10.20	0.4016	43.0	89.0	10.20
A11710.5	–	10.50	0.4134	43.0	89.0	10.50
A11711.0	–	11.00	0.4331	47.0	95.0	11.00
A11711.5	–	11.50	0.4528	47.0	95.0	11.50
A11712.0	–	12.00	0.4724	51.0	102.0	12.00
A1171/2	1/2	12.70	0.5000	51.0	102.0	12.70
A11713.0	–	13.00	0.5118	51.0	102.0	13.00

A777



HSS-E (8% Cobalt) Jobber Drill, Bronze Tempered Finish

A top performer, producing accurate sized holes with a quality finish in high strength materials. The 135° split point helps to self-center. The bronze finish is a thin oxide layer formed on the tool surface and is an indication for 8% Cobalt HSS-E Drill.

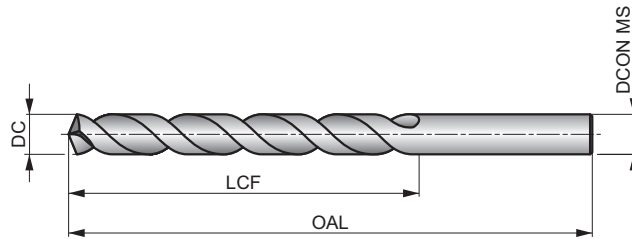

HSS-E	DIN 338	4×D
135°	Bronze	
λ20-35°	R	DC h8

Workpiece material group suitability, starting values for cutting speed (m/min) and feed Alpha Code. Tables with feed per revolution can be found starting from page 71.

P1.1 ▣36 H	P1.2 ▣40 H	P1.3 ▣41 H	P2.1 ▣31 H	P2.2 ▣27 G	P2.3 ▣24 E	P3.1 ▣25 F	P3.2 ▣20 F	P3.3 ▣17 E	P4.1 ▣15 F	P4.2 ▣13 E	P4.3 ▣10 D	M1.1 ▣30 E	M1.2 ▣26 E
M2.1 ▣27 E	M2.2 ▣22 E	M3.1 ▣13 G	M3.2 ▣11 G	M3.3 ▣10 G	M4.1 ▣15 C	K1.1 ▣35 H	K1.2 ▣26 D	K1.3 ▣19 D	K2.1 ▣27 E	K2.2 ▣22 E	K2.3 ▣18 E	K3.1 ▣24 E	K3.2 ▣18 E
K3.3 ▣15 E	K4.1 ▣22 E	K4.2 ▣17 E	K4.3 ▣12 E	K4.4 ▣11 E	K4.5 ▣9 E	K5.1 ▣25 E	K5.2 ▣19 E	K5.3 ▣15 E	N1.1 ▣33 J	N1.2 ▣25 J	N1.3 ▣17 I	N2.1 ▣46 H	N2.2 ▣42 H
N2.3 ▣30 H	N3.1 ▣68 H	N3.2 ▣40 F	N3.3 ▣20 H	S1.1 ▣28 F	S1.2 ▣20 D	S1.3 ▣11 C	S2.1 ▣9 E	S2.2 ▣8 B	S3.1 ▣7 E	S3.2 ▣6 B	S4.1 ▣5 E	S4.2 ▣5 B	

NAS907J. DC <= 1.4mm 4 Facet Point.

Products from this series are also available in set. Please see A295.

Product	DC	DC	DC	LCF	OAL	DCON MS	Product	DC	DC	DC	LCF	OAL	DCON MS
	(inch)	(mm)	(inch)	(mm)	(mm)	(mm)		(inch)	(mm)	(inch)	(mm)	(mm)	(mm)
A777.3	–	0.30	0.0118	3.0	19.0	0.30	A7772.0	–	2.00	0.0787	24.0	49.0	2.00
A777.35	–	0.35	0.0138	4.0	19.0	0.35	A7772.1	–	2.10	0.0827	24.0	49.0	2.10
A777.4	–	0.40	0.0157	5.0	20.0	0.40	A7772.2	–	2.20	0.0866	27.0	53.0	2.20
A777.45	–	0.45	0.0177	5.0	20.0	0.45	A7772.3	–	2.30	0.0906	27.0	53.0	2.30
A777.5	–	0.50	0.0197	6.0	22.0	0.50	A7773/32	3/32	2.38	0.0938	30.0	57.0	2.38
A777.55	–	0.55	0.0217	7.0	24.0	0.55	A7772.4	–	2.40	0.0945	30.0	57.0	2.40
A777.6	–	0.60	0.0236	7.0	24.0	0.60	A7772.5	–	2.50	0.0984	30.0	57.0	2.50
A777.65	–	0.65	0.0256	8.0	26.0	0.65	A7772.6	–	2.60	0.1024	30.0	57.0	2.60
A777.7	–	0.70	0.0276	9.0	28.0	0.70	A7772.7	–	2.70	0.1063	33.0	61.0	2.70
A777.8	–	0.80	0.0315	10.0	30.0	0.80	A7777/64	7/64	2.78	0.1094	33.0	61.0	2.78
A777.9	–	0.90	0.0354	11.0	32.0	0.90	A7772.8	–	2.80	0.1102	33.0	61.0	2.80
A777.95	–	0.95	0.0374	11.0	32.0	0.95	A7772.9	–	2.90	0.1142	33.0	61.0	2.90
A7771.0	–	1.00	0.0394	12.0	34.0	1.00	A7773.0	–	3.00	0.1181	33.0	61.0	3.00
A7771.1	–	1.10	0.0433	14.0	36.0	1.10	A7773.1	–	3.10	0.1220	36.0	65.0	3.10
A7771.2	–	1.20	0.0472	16.0	38.0	1.20	A7771/8	1/8	3.18	0.1250	36.0	65.0	3.18
A7771.3	–	1.30	0.0512	16.0	38.0	1.30	A7773.2	–	3.20	0.1260	36.0	65.0	3.20
A7771.4	–	1.40	0.0551	18.0	40.0	1.40	A7773.3	–	3.30	0.1299	36.0	65.0	3.30
A7771.5	–	1.50	0.0591	18.0	40.0	1.50	A7773.4	–	3.40	0.1339	39.0	70.0	3.40
A7771/16	1/16	1.59	0.0625	20.0	43.0	1.59	A7773.5	–	3.50	0.1378	39.0	70.0	3.50
A7771.6	–	1.60	0.0630	20.0	43.0	1.60	A7779/64	9/64	3.57	0.1406	39.0	70.0	3.57
A7771.7	–	1.70	0.0669	20.0	43.0	1.70	A7773.6	–	3.60	0.1417	39.0	70.0	3.60
A7771.8	–	1.80	0.0709	22.0	46.0	1.80	A7773.7	–	3.70	0.1457	39.0	70.0	3.70
A7771.9	–	1.90	0.0748	22.0	46.0	1.90	A7773.8	–	3.80	0.1496	43.0	75.0	3.80
A7775/64	5/64	1.98	0.0781	24.0	49.0	1.98	A7773.9	–	3.90	0.1535	43.0	75.0	3.90



Product	DC	DC	DC	LCF	OAL	DCON MS
	(inch)	(mm)	(inch)	(mm)	(mm)	(mm)
A7775/32	5/32	3.97	0.1563	43.0	75.0	3.97
A7774.0	–	4.00	0.1575	43.0	75.0	4.00
A7774.1	–	4.10	0.1614	43.0	75.0	4.10
A7774.2	–	4.20	0.1654	43.0	75.0	4.20
A7774.3	–	4.30	0.1693	47.0	80.0	4.30
A77711/64	11/64	4.37	0.1719	47.0	80.0	4.37
A7774.4	–	4.40	0.1732	47.0	80.0	4.40
A7774.5	–	4.50	0.1772	47.0	80.0	4.50
A7774.6	–	4.60	0.1811	47.0	80.0	4.60
A7774.7	–	4.70	0.1850	47.0	80.0	4.70
A7773/16	3/16	4.76	0.1875	52.0	86.0	4.76
A7774.8	–	4.80	0.1890	52.0	86.0	4.80
A7774.9	–	4.90	0.1929	52.0	86.0	4.90
A7775.0	–	5.00	0.1969	52.0	86.0	5.00
A7775.1	–	5.10	0.2008	52.0	86.0	5.10
A77713/64	13/64	5.16	0.2031	52.0	86.0	5.16
A7775.2	–	5.20	0.2047	52.0	86.0	5.20
A7775.3	–	5.30	0.2087	52.0	86.0	5.30
A7775.4	–	5.40	0.2126	57.0	93.0	5.40
A7775.5	–	5.50	0.2165	57.0	93.0	5.50
A7777/32	7/32	5.56	0.2188	57.0	93.0	5.56
A7775.6	–	5.60	0.2205	57.0	93.0	5.60
A7775.7	–	5.70	0.2244	57.0	93.0	5.70
A7775.8	–	5.80	0.2283	57.0	93.0	5.80
A7775.9	–	5.90	0.2323	57.0	93.0	5.90
A77715/64	15/64	5.95	0.2344	57.0	93.0	5.95
A7776.0	–	6.00	0.2362	57.0	93.0	6.00
A7776.1	–	6.10	0.2402	63.0	101.0	6.10
A7776.2	–	6.20	0.2441	63.0	101.0	6.20
A7776.3	–	6.30	0.2480	63.0	101.0	6.30
A7771/4	1/4	6.35	0.2500	63.0	101.0	6.35
A7776.4	–	6.40	0.2520	63.0	101.0	6.40
A7776.5	–	6.50	0.2559	63.0	101.0	6.50
A7776.6	–	6.60	0.2598	63.0	101.0	6.60
A7776.7	–	6.70	0.2638	63.0	101.0	6.70
A77717/64	17/64	6.75	0.2656	69.0	109.0	6.75
A7776.8	–	6.80	0.2677	69.0	109.0	6.80
A7776.9	–	6.90	0.2717	69.0	109.0	6.90
A7777.0	–	7.00	0.2756	69.0	109.0	7.00
A7777.1	–	7.10	0.2795	69.0	109.0	7.10
A7779/32	9/32	7.14	0.2813	69.0	109.0	7.14
A7777.2	–	7.20	0.2835	69.0	109.0	7.20
A7777.3	–	7.30	0.2874	69.0	109.0	7.30
A7777.4	–	7.40	0.2913	69.0	109.0	7.40
A7777.5	–	7.50	0.2953	69.0	109.0	7.50
A77719/64	19/64	7.54	0.2969	75.0	117.0	7.54
A7777.6	–	7.60	0.2992	75.0	117.0	7.60
A7777.7	–	7.70	0.3031	75.0	117.0	7.70
A7777.8	–	7.80	0.3071	75.0	117.0	7.80
A7777.9	–	7.90	0.3110	75.0	117.0	7.90
A7775/16	5/16	7.94	0.3125	75.0	117.0	7.94
A7778.0	–	8.00	0.3150	75.0	117.0	8.00

Product	DC	DC	DC	LCF	OAL	DCON MS
	(inch)	(mm)	(inch)	(mm)	(mm)	(mm)
A7778.1	–	8.10	0.3189	75.0	117.0	8.10
A7778.2	–	8.20	0.3228	75.0	117.0	8.20
A7778.3	–	8.30	0.3268	75.0	117.0	8.30
A77721/64	21/64	8.33	0.3281	75.0	117.0	8.33
A7778.4	–	8.40	0.3307	75.0	117.0	8.40
A7778.5	–	8.50	0.3346	75.0	117.0	8.50
A7778.6	–	8.60	0.3386	81.0	125.0	8.60
A7778.7	–	8.70	0.3425	81.0	125.0	8.70
A77711/32	11/32	8.73	0.3438	81.0	125.0	8.73
A7778.8	–	8.80	0.3465	81.0	125.0	8.80
A7778.9	–	8.90	0.3504	81.0	125.0	8.90
A7779.0	–	9.00	0.3543	81.0	125.0	9.00
A7779.1	–	9.10	0.3583	81.0	125.0	9.10
A77723/64	23/64	9.13	0.3594	81.0	125.0	9.13
A7779.2	–	9.20	0.3622	81.0	125.0	9.20
A7779.3	–	9.30	0.3661	81.0	125.0	9.30
A7779.4	–	9.40	0.3701	81.0	125.0	9.40
A7779.5	–	9.50	0.3740	81.0	125.0	9.50
A7773/8	3/8	9.52	0.3750	87.0	133.0	9.52
A7779.6	–	9.60	0.3780	87.0	133.0	9.60
A7779.7	–	9.70	0.3819	87.0	133.0	9.70
A7779.8	–	9.80	0.3858	87.0	133.0	9.80
A7779.9	–	9.90	0.3898	87.0	133.0	9.90
A77725/64	25/64	9.92	0.3906	87.0	133.0	9.92
A77710.0	–	10.00	0.3937	87.0	133.0	10.00
A77710.1	–	10.10	0.3976	87.0	133.0	10.10
A77710.2	–	10.20	0.4016	87.0	133.0	10.20
A77713/32	13/32	10.32	0.4063	87.0	133.0	10.32
A77710.5	–	10.50	0.4134	87.0	133.0	10.50
A77727/64	27/64	10.72	0.4219	94.0	142.0	10.72
A77710.8	–	10.80	0.4252	94.0	142.0	10.80
A77711.0	–	11.00	0.4331	94.0	142.0	11.00
A7777/16	7/16	11.11	0.4375	94.0	142.0	11.11
A77711.2	–	11.20	0.4409	94.0	142.0	11.20
A77711.5	–	11.50	0.4528	94.0	142.0	11.50
A77729/64	29/64	11.51	0.4531	94.0	142.0	11.51
A77711.8	–	11.80	0.4646	94.0	142.0	11.80
A77715/32	15/32	11.91	0.4688	101.0	151.0	11.91
A77712.0	–	12.00	0.4724	101.0	151.0	12.00
A77712.2	–	12.20	0.4803	101.0	151.0	12.20
A77731/64	31/64	12.30	0.4844	101.0	151.0	12.30
A77712.5	–	12.50	0.4921	101.0	151.0	12.50
A7771/2	1/2	12.70	0.5000	101.0	151.0	12.70
A77712.8	–	12.80	0.5039	101.0	151.0	12.80
A77713.0	–	13.00	0.5118	101.0	151.0	13.00
A77713.5	–	13.50	0.5315	108.0	160.0	13.50
A77714.0	–	14.00	0.5512	108.0	160.0	14.00
A77714.5	–	14.50	0.5709	114.0	169.0	14.50
A77715.0	–	15.00	0.5906	114.0	169.0	15.00
A77715.5	–	15.50	0.6102	120.0	178.0	15.50
A77716.0	–	16.00	0.6299	120.0	178.0	16.00

A124



HSS Stub Drill, Steam Tempered Finish, with Brazed Carbide Point

Brazed carbide tip gives the high performance of a carbide drill with a strong and less brittle HSS body. A 118°, 4-facet point, helps with selfcentering making it an economical choice. It can be used in both conventional and CNC machines. Steam tempered finish retains cutting fluid.

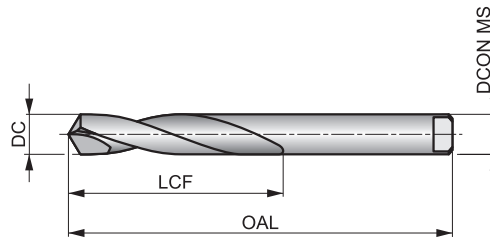

HSS HM	DIN 8037	2.5×D
118°	Bright ST	
λ10-20°	R	

Workpiece material group suitability, starting values for cutting speed (m/min) and feed Alpha Code. Tables with feed per revolution can be found starting from page 71.

P2.3 ▣40 C	P3.3 ▣40 C	P4.2 ▣30 C	P4.3 ▣24 A	M3.1 ▣41 C	M3.2 ▣35 C	M3.3 ▣32 C	M4.1 ▣35 C	K1.1 ▣55 C	K1.2 ▣41 C	K1.3 ▣31 C	K2.1 ▣49 C	K2.2 ▣40 C	K2.3 ▣32 A
K3.1 ▣44 C	K3.2 ▣33 C	K3.3 ▣27 A	K4.1 ▣40 C	K4.2 ▣30 C	K4.3 ▣22 A	K4.4 ▣19 A	K4.5 ▣16 A	K5.1 ▣46 C	K5.2 ▣34 C	K5.3 ▣27 A	N3.1 ▣119 E	N3.2 ▣70 G	N4.2 ▣60 E
S1.1 ▣40 A	S1.2 ▣35 A	S1.3 ▣25 A	S2.1 ▣33 A	S2.2 ▣28 A	S3.1 ▣25 A	S3.2 ▣20 A	S4.1 ▣20 A	S4.2 ▣16 A					

Tang to DIN 1809.

Product	DC	DC	LCF	OAL	DCON MS
	(mm)	(inch)			
A1243.0	3.00	0.1181	20.0	50.0	3.00
A1243.2	3.20	0.1260	25.0	56.0	3.20
A1243.5	3.50	0.1378	25.0	56.0	3.50
A1244.0	4.00	0.1575	25.0	56.0	4.00
A1244.2	4.20	0.1654	28.0	63.0	4.20
A1244.5	4.50	0.1772	28.0	63.0	4.50
A1244.8	4.80	0.1890	28.0	63.0	4.80
A1245.0	5.00	0.1969	28.0	63.0	5.00
A1245.2	5.20	0.2047	32.0	71.0	5.20
A1245.5	5.50	0.2165	32.0	71.0	5.50
A1245.8	5.80	0.2283	32.0	71.0	5.80
A1246.0	6.00	0.2362	32.0	71.0	6.00
A1246.5	6.50	0.2559	32.0	71.0	6.50
A1246.8	6.80	0.2677	40.0	80.0	6.80
A1247.0	7.00	0.2756	40.0	80.0	7.00

Product	DC	DC	LCF	OAL	DCON MS
	(mm)	(inch)			
A1247.5	7.50	0.2953	40.0	80.0	7.50
A1248.0	8.00	0.3150	40.0	80.0	8.00
A1248.5	8.50	0.3346	50.0	90.0	8.50
A1249.0	9.00	0.3543	50.0	90.0	9.00
A1249.5	9.50	0.3740	50.0	90.0	9.50
A12410.0	10.00	0.3937	56.0	100.0	10.00
A12410.5	10.50	0.4134	56.0	100.0	10.50
A12411.0	11.00	0.4331	56.0	100.0	11.00
A12411.5	11.50	0.4528	63.0	112.0	11.50
A12412.0	12.00	0.4724	63.0	112.0	12.00
A12413.0	13.00	0.5118	63.0	112.0	13.00
A12414.0	14.00	0.5512	71.0	125.0	14.00
A12415.0	15.00	0.5906	71.0	125.0	15.00
A12416.0	16.00	0.6299	80.0	140.0	16.00

A160



HSS Jobber Drill, Steam Tempered Finish, with Brazed Carbide Point

HSS body with a brazed carbide tip, giving the performance of a carbide drill with a strong and flexible body. It has a 118°, 4-facet self-centering point making it an economical choice when drilling cast iron materials. It can be used in both conventional and CNC machines.

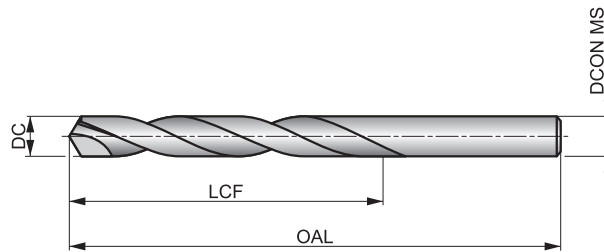

HSS HM	DIN 338	4×D
118°	Bright ST	
λ 20-35°	R	DC h8

Workpiece material group suitability, starting values for cutting speed (m/min) and feed Alpha Code. Tables with feed per revolution can be found starting from page 71.

P1.1 ▣73 E	P1.2 ▣82 E	P1.3 ▣85 E	P2.1 ▣63 E	P2.2 ▣55 D	P2.3 ▣49 C	P3.1 ▣59 D	P3.2 ▣47 D	P3.3 ▣40 C	P4.1 ▣35 D	P4.2 ▣30 C	P4.3 ▣24 A	M1.1 ▣55 B	M1.2 ▣46 B
M2.1 ▣49 B	M2.2 ▣40 B	M3.1 ▣41 C	M3.2 ▣35 C	M3.3 ▣32 C	M4.1 ▣35 A	K1.1 ▣50 C	K1.2 ▣37 A	K1.3 ▣28 A	K2.1 ▣43 A	K2.2 ▣35 A	K2.3 ▣28 A	K3.1 ▣38 A	K3.2 ▣29 A
K3.3 ▣24 A	K4.1 ▣35 A	K4.2 ▣27 A	K4.3 ▣20 A	K4.4 ▣17 A	K4.5 ▣14 A	K5.1 ▣40 A	K5.2 ▣30 A	K5.3 ▣23 A	N1.1 ▣50 I	N1.2 ▣38 I	N1.3 ▣25 H	N2.1 ▣62 G	N2.2 ▣55 G
N2.3 ▣40 G	N3.1 ▣119 C	N3.2 ▣70 G	N3.3 ▣35 D	N4.2 ▣60 E	S1.1 ▣35 A	S1.2 ▣35 A	S1.3 ▣25 A	S2.1 ▣33 A	S2.2 ▣28 A	S3.1 ▣25 A	S3.2 ▣20 A	S4.1 ▣20 A	S4.2 ▣16 A

Product	DC		LCF	OAL	DCON MS
	(mm)	(inch)			
A1604.0	4.00	0.1575	43.0	75.0	4.00
A1604.5	4.50	0.1772	47.0	80.0	4.50
A1605.0	5.00	0.1969	52.0	86.0	5.00
A1605.5	5.50	0.2165	57.0	93.0	5.50
A1606.0	6.00	0.2362	57.0	93.0	6.00
A1606.5	6.50	0.2559	63.0	101.0	6.50
A1606.8	6.80	0.2677	69.0	109.0	6.80
A1607.0	7.00	0.2756	69.0	109.0	7.00
A1607.5	7.50	0.2953	69.0	109.0	7.50
A1608.0	8.00	0.3150	75.0	117.0	8.00
A1608.5	8.50	0.3346	75.0	117.0	8.50
A1609.0	9.00	0.3543	81.0	125.0	9.00
A1609.5	9.50	0.3740	81.0	125.0	9.50
A16010.0	10.00	0.3937	87.0	133.0	10.00
A16010.2	10.20	0.4016	87.0	133.0	10.20
A16010.5	10.50	0.4134	87.0	133.0	10.50
A16011.0	11.00	0.4331	94.0	142.0	11.00
A16011.5	11.50	0.4528	94.0	142.0	11.50
A16012.0	12.00	0.4724	101.0	151.0	12.00
A16013.0	13.00	0.5118	101.0	151.0	13.00
A16014.0	14.00	0.5512	108.0	160.0	14.00
A16015.0	15.00	0.5906	114.0	169.0	15.00
A16016.0	16.00	0.6299	120.0	178.0	16.00

R120

Solid Carbide Stub Drill, Bright Finish

Improved wear resistance for increased productivity and extended tool life. A 120°, 4-facet point helps with self-centering and reduces cutting forces. Suitable for drilling hard and abrasive materials and can be used with all CNC machine applications.

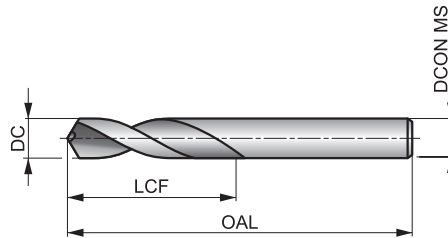

HM	DIN 6539	2.5×D
120°	Bright	
λ _{20-35°}	R	DC h7

Workpiece material group suitability, starting values for cutting speed (m/min) and feed Alpha Code. Tables with feed per revolution can be found starting from page 71.

P1.1 ▣99 S	P1.2 ▣111 S	P1.3 ▣115 S	P2.1 ▣85 S	P2.2 ▣75 S	P2.3 ▣66 S	P3.1 ▣66 S	P3.2 ▣53 S	P3.3 ▣45 S	P4.1 ▣40 S	P4.2 ▣34 S	P4.3 ▣27 S	K1.1 ▣75 U	K1.2 ▣56 U
K1.3 ▣42 U	K2.1 ▣68 U	K2.2 ▣55 U	K2.3 ▣44 U	K3.1 ▣60 U	K3.2 ▣46 U	K3.3 ▣37 U	K4.1 ▣55 U	K4.2 ▣42 U	K4.3 ▣31 U	K4.4 ▣26 U	K4.5 ▣22 U	K5.1 ▣63 U	K5.2 ▣47 U
K5.3 ▣37 U	N1.1 ▣200 W	N1.2 ▣150 W	N1.3 ▣100 W	N2.1 ▣172 W	N2.2 ▣155 W	N2.3 ▣112 W	N3.1 ▣466 W	N3.2 ▣275 W	N3.3 ▣138 W	N4.1 ▣60 U	N4.2 ▣100 U	S1.1 ▣45 T	S1.2 ▣35 T
S1.3 ▣25 T	S2.1 ▣40 T	S2.2 ▣28 T	S3.1 ▣30 T	S3.2 ▣20 T	S4.1 ▣23 T	S4.2 ▣16 T	H1.1 ▣56 S	H2.1 ▣33 S	H2.2 ▣36 S	H3.1 ▣37 S	H3.2 ▣30 S		

Product	DC	DC	LCF	OAL	DCON MS
	(mm)	(inch)			
R1201.0	1.00	0.0394	6.0	26.0	1.00
R1201.1	1.10	0.0433	7.0	28.0	1.10
R1201.2	1.20	0.0472	8.0	30.0	1.20
R1201.3	1.30	0.0512	8.0	30.0	1.30
R1201.4	1.40	0.0551	9.0	32.0	1.40
R1201.5	1.50	0.0591	9.0	32.0	1.50
R1201.6	1.60	0.0630	10.0	34.0	1.60
R1201.7	1.70	0.0669	10.0	34.0	1.70
R1201.8	1.80	0.0709	11.0	36.0	1.80
R1201.9	1.90	0.0748	11.0	36.0	1.90
R1202.0	2.00	0.0787	12.0	38.0	2.00
R1202.1	2.10	0.0827	12.0	38.0	2.10
R1202.2	2.20	0.0866	13.0	40.0	2.20
R1202.3	2.30	0.0906	13.0	40.0	2.30
R1202.4	2.40	0.0945	14.0	43.0	2.40
R1202.5	2.50	0.0984	14.0	43.0	2.50
R1202.6	2.60	0.1024	14.0	43.0	2.60
R1202.7	2.70	0.1063	16.0	46.0	2.70
R1202.8	2.80	0.1102	16.0	46.0	2.80
R1202.9	2.90	0.1142	16.0	46.0	2.90
R1203.0	3.00	0.1181	16.0	46.0	3.00
R1203.1	3.10	0.1220	18.0	49.0	3.10
R1203.2	3.20	0.1260	18.0	49.0	3.20
R1203.3	3.30	0.1299	18.0	49.0	3.30
R1203.4	3.40	0.1339	20.0	52.0	3.40
R1203.5	3.50	0.1378	20.0	52.0	3.50

Product	DC	DC	LCF	OAL	DCON MS
	(mm)	(inch)			
R1203.6	3.60	0.1417	20.0	52.0	3.60
R1203.7	3.70	0.1457	20.0	52.0	3.70
R1203.8	3.80	0.1496	22.0	55.0	3.80
R1203.9	3.90	0.1535	22.0	55.0	3.90
R1204.0	4.00	0.1575	22.0	55.0	4.00
R1204.1	4.10	0.1614	22.0	55.0	4.10
R1204.2	4.20	0.1654	22.0	55.0	4.20
R1204.3	4.30	0.1693	24.0	58.0	4.30
R1204.4	4.40	0.1732	24.0	58.0	4.40
R1204.5	4.50	0.1772	24.0	58.0	4.50
R1204.6	4.60	0.1811	24.0	58.0	4.60
R1204.7	4.70	0.1850	24.0	58.0	4.70
R1204.8	4.80	0.1890	26.0	62.0	4.80
R1204.9	4.90	0.1929	26.0	62.0	4.90
R1205.0	5.00	0.1969	26.0	62.0	5.00
R1205.1	5.10	0.2008	26.0	62.0	5.10
R1205.2	5.20	0.2047	26.0	62.0	5.20
R1205.3	5.30	0.2087	26.0	62.0	5.30
R1205.4	5.40	0.2126	28.0	66.0	5.40
R1205.5	5.50	0.2165	28.0	66.0	5.50
R1205.6	5.60	0.2205	28.0	66.0	5.60
R1205.7	5.70	0.2244	28.0	66.0	5.70
R1205.8	5.80	0.2283	28.0	66.0	5.80
R1205.9	5.90	0.2323	28.0	66.0	5.90
R1206.0	6.00	0.2362	28.0	66.0	6.00
R1206.1	6.10	0.2402	31.0	70.0	6.10



Product	DC	DC	LCF	OAL	DCON MS
	(mm)	(inch)	(mm)	(mm)	(mm)
R1206.2	6.20	0.2441	31.0	70.0	6.20
R1206.3	6.30	0.2480	31.0	70.0	6.30
R1206.4	6.40	0.2520	31.0	70.0	6.40
R1206.5	6.50	0.2559	31.0	70.0	6.50
R1206.6	6.60	0.2598	31.0	70.0	6.60
R1206.7	6.70	0.2638	31.0	70.0	6.70
R1206.8	6.80	0.2677	34.0	74.0	6.80
R1206.9	6.90	0.2717	34.0	74.0	6.90
R1207.0	7.00	0.2756	34.0	74.0	7.00
R1207.1	7.10	0.2795	34.0	74.0	7.10
R1207.2	7.20	0.2835	34.0	74.0	7.20
R1207.3	7.30	0.2874	34.0	74.0	7.30
R1207.4	7.40	0.2913	34.0	74.0	7.40
R1207.5	7.50	0.2953	34.0	74.0	7.50
R1207.6	7.60	0.2992	37.0	79.0	7.60
R1207.7	7.70	0.3031	37.0	79.0	7.70
R1207.8	7.80	0.3071	37.0	79.0	7.80
R1207.9	7.90	0.3110	37.0	79.0	7.90
R1208.0	8.00	0.3150	37.0	79.0	8.00
R1208.1	8.10	0.3189	37.0	79.0	8.10
R1208.2	8.20	0.3228	37.0	79.0	8.20
R1208.3	8.30	0.3268	37.0	79.0	8.30

Product	DC	DC	LCF	OAL	DCON MS
	(mm)	(inch)	(mm)	(mm)	(mm)
R1208.4	8.40	0.3307	37.0	79.0	8.40
R1208.5	8.50	0.3346	37.0	79.0	8.50
R1208.6	8.60	0.3386	40.0	84.0	8.60
R1208.7	8.70	0.3425	40.0	84.0	8.70
R1208.8	8.80	0.3465	40.0	84.0	8.80
R1208.9	8.90	0.3504	40.0	84.0	8.90
R1209.0	9.00	0.3543	40.0	84.0	9.00
R1209.1	9.10	0.3583	40.0	84.0	9.10
R1209.2	9.20	0.3622	40.0	84.0	9.20
R1209.3	9.30	0.3661	40.0	84.0	9.30
R1209.4	9.40	0.3701	40.0	84.0	9.40
R1209.5	9.50	0.3740	40.0	84.0	9.50
R1209.6	9.60	0.3780	43.0	89.0	9.60
R1209.7	9.70	0.3819	43.0	89.0	9.70
R1209.8	9.80	0.3858	43.0	89.0	9.80
R1209.9	9.90	0.3898	43.0	89.0	9.90
R12010.0	10.00	0.3937	43.0	89.0	10.00
R12010.2	10.20	0.4016	43.0	89.0	10.20
R12010.5	10.50	0.4134	43.0	89.0	10.50
R12011.0	11.00	0.4331	47.0	95.0	11.00
R12011.5	11.50	0.4528	47.0	95.0	11.50
R12012.0	12.00	0.4724	51.0	102.0	12.00

R100

Solid Carbide Jobber Drill, Bright Finish

Improved wear resistance for increased productivity and extended tool life. A 120°, 4-facet point helps with self-centering and reduces cutting forces. Can be used with all CNC machine applications.

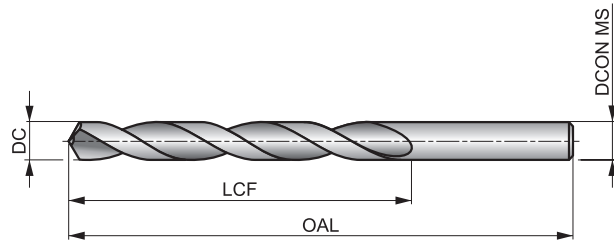

HM	DIN 338	4×D
120°	Bright	
λ 20-35°	R	DC h7

Workpiece material group suitability, starting values for cutting speed (m/min) and feed Alpha Code. Tables with feed per revolution can be found starting from page 71.

P1.1 ☒99 S	P1.2 ☒111 S	P1.3 ☒115 S	P2.1 ☒85 S	P2.2 ☒75 S	P2.3 ☒66 S	P3.1 ☒66 S	P3.2 ☒53 S	P3.3 ☒45 S	P4.1 ☒40 S	P4.2 ☒34 S	P4.3 ☒27 S	K1.1 ☒75 T	K1.2 ☒56 T
K1.3 ☒42 T	K2.1 ☒68 T	K2.2 ☒55 T	K2.3 ☒44 T	K3.1 ☒60 T	K3.2 ☒46 T	K3.3 ☒37 T	K4.1 ☒55 T	K4.2 ☒42 T	K4.3 ☒31 T	K4.4 ☒26 T	K4.5 ☒22 T	K5.1 ☒63 T	K5.2 ☒47 T
K5.3 ☒37 T	N1.1 ☒200 V	N1.2 ☒150 V	N1.3 ☒100 V	N2.1 ☒172 V	N2.2 ☒155 V	N2.3 ☒112 V	N3.1 ☒423 V	N3.2 ☒250 V	N4.1 ☒60 X	N4.2 ☒100 V	H1.1 ☒56 S	H2.1 ☒33 S	H2.2 ☒36 S
H3.1 ☒37 S	H3.2 ☒30 S												

Product	DC	DC	LCF	OAL	DCON MS
	(mm)	(inch)			
R1001.0	1.00	0.0394	12.0	34.0	1.00
R1001.1	1.10	0.0433	14.0	36.0	1.10
R1001.2	1.20	0.0472	16.0	38.0	1.20
R1001.3	1.30	0.0512	16.0	38.0	1.30
R1001.4	1.40	0.0551	18.0	40.0	1.40
R1001.5	1.50	0.0591	18.0	40.0	1.50
R1001.6	1.60	0.0630	20.0	43.0	1.60
R1001.7	1.70	0.0669	20.0	43.0	1.70
R1001.8	1.80	0.0709	22.0	46.0	1.80
R1001.9	1.90	0.0748	22.0	46.0	1.90
R1002.0	2.00	0.0787	24.0	49.0	2.00
R1002.1	2.10	0.0827	24.0	49.0	2.10
R1002.2	2.20	0.0866	27.0	53.0	2.20
R1002.3	2.30	0.0906	27.0	53.0	2.30
R1002.4	2.40	0.0945	30.0	57.0	2.40
R1002.5	2.50	0.0984	30.0	57.0	2.50
R1002.6	2.60	0.1024	30.0	57.0	2.60
R1002.7	2.70	0.1063	33.0	61.0	2.70
R1002.8	2.80	0.1102	33.0	61.0	2.80
R1002.9	2.90	0.1142	33.0	61.0	2.90
R1003.0	3.00	0.1181	33.0	61.0	3.00
R1003.1	3.10	0.1220	36.0	65.0	3.10
R1003.2	3.20	0.1260	36.0	65.0	3.20
R1003.3	3.30	0.1299	36.0	65.0	3.30
R1003.4	3.40	0.1339	39.0	70.0	3.40
R1003.5	3.50	0.1378	39.0	70.0	3.50

Product	DC	DC	LCF	OAL	DCON MS
	(mm)	(inch)			
R1003.6	3.60	0.1417	39.0	70.0	3.60
R1003.7	3.70	0.1457	39.0	70.0	3.70
R1003.8	3.80	0.1496	43.0	75.0	3.80
R1003.9	3.90	0.1535	43.0	75.0	3.90
R1004.0	4.00	0.1575	43.0	75.0	4.00
R1004.1	4.10	0.1614	43.0	75.0	4.10
R1004.2	4.20	0.1654	43.0	75.0	4.20
R1004.3	4.30	0.1693	47.0	80.0	4.30
R1004.4	4.40	0.1732	47.0	80.0	4.40
R1004.5	4.50	0.1772	47.0	80.0	4.50
R1004.6	4.60	0.1811	47.0	80.0	4.60
R1004.7	4.70	0.1850	47.0	80.0	4.70
R1004.8	4.80	0.1890	52.0	86.0	4.80
R1004.9	4.90	0.1929	52.0	86.0	4.90
R1005.0	5.00	0.1969	52.0	86.0	5.00
R1005.1	5.10	0.2008	52.0	86.0	5.10
R1005.2	5.20	0.2047	52.0	86.0	5.20
R1005.3	5.30	0.2087	52.0	86.0	5.30
R1005.4	5.40	0.2126	57.0	93.0	5.40
R1005.5	5.50	0.2165	57.0	93.0	5.50
R1005.6	5.60	0.2205	57.0	93.0	5.60
R1005.7	5.70	0.2244	57.0	93.0	5.70
R1005.8	5.80	0.2283	57.0	93.0	5.80
R1005.9	5.90	0.2323	57.0	93.0	5.90
R1006.0	6.00	0.2362	57.0	93.0	6.00
R1006.1	6.10	0.2402	63.0	101.0	6.10



Product	DC	DC	LCF	OAL	DCON MS
	(mm)	(inch)	(mm)	(mm)	(mm)
R1006.2	6.20	0.2441	63.0	101.0	6.20
R1006.3	6.30	0.2480	63.0	101.0	6.30
R1006.4	6.40	0.2520	63.0	101.0	6.40
R1006.5	6.50	0.2559	63.0	101.0	6.50
R1006.6	6.60	0.2598	63.0	101.0	6.60
R1006.7	6.70	0.2638	63.0	101.0	6.70
R1006.8	6.80	0.2677	69.0	109.0	6.80
R1006.9	6.90	0.2717	69.0	109.0	6.90
R1007.0	7.00	0.2756	69.0	109.0	7.00
R1007.1	7.10	0.2795	69.0	109.0	7.10
R1007.2	7.20	0.2835	69.0	109.0	7.20
R1007.3	7.30	0.2874	69.0	109.0	7.30
R1007.4	7.40	0.2913	69.0	109.0	7.40
R1007.5	7.50	0.2953	69.0	109.0	7.50
R1007.6	7.60	0.2992	75.0	117.0	7.60
R1007.7	7.70	0.3031	75.0	117.0	7.70
R1007.8	7.80	0.3071	75.0	117.0	7.80
R1007.9	7.90	0.3110	75.0	117.0	7.90
R1008.0	8.00	0.3150	75.0	117.0	8.00
R1008.1	8.10	0.3189	75.0	117.0	8.10
R1008.2	8.20	0.3228	75.0	117.0	8.20
R1008.3	8.30	0.3268	75.0	117.0	8.30
R1008.4	8.40	0.3307	75.0	117.0	8.40

Product	DC	DC	LCF	OAL	DCON MS
	(mm)	(inch)	(mm)	(mm)	(mm)
R1008.5	8.50	0.3346	75.0	117.0	8.50
R1008.6	8.60	0.3386	81.0	125.0	8.60
R1008.7	8.70	0.3425	81.0	125.0	8.70
R1008.8	8.80	0.3465	81.0	125.0	8.80
R1008.9	8.90	0.3504	81.0	125.0	8.90
R1009.0	9.00	0.3543	81.0	125.0	9.00
R1009.1	9.10	0.3583	81.0	125.0	9.10
R1009.2	9.20	0.3622	81.0	125.0	9.20
R1009.3	9.30	0.3661	81.0	125.0	9.30
R1009.4	9.40	0.3701	81.0	125.0	9.40
R1009.5	9.50	0.3740	81.0	125.0	9.50
R1009.6	9.60	0.3780	87.0	133.0	9.60
R1009.7	9.70	0.3819	87.0	133.0	9.70
R1009.8	9.80	0.3858	87.0	133.0	9.80
R1009.9	9.90	0.3898	87.0	133.0	9.90
R10010.0	10.00	0.3937	87.0	133.0	10.00
R10010.2	10.20	0.4016	87.0	133.0	10.20
R10010.5	10.50	0.4134	87.0	133.0	10.50
R10011.0	11.00	0.4331	94.0	142.0	11.00
R10011.5	11.50	0.4528	94.0	142.0	11.50
R10012.0	12.00	0.4724	101.0	151.0	12.00
R10013.0	13.00	0.5118	101.0	151.0	13.00
R10014.0	14.00	0.5512	108.0	160.0	14.00

A123



HSS Stub Drill, Steam Tempered Finish, for Sheet Metal

Specially designed for drilling thin materials and sheet metal. A 120° point and a steam tempered finish which stops workpiece material from sticking to the cutting edge, giving a better hole finish and more accurate diameter. Suitable for drilling in many materials.

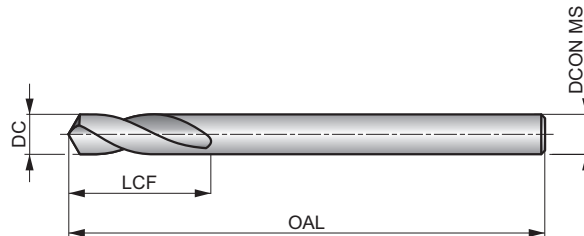

HSS	DIN 1897	1.5×D
120°	ST	
λ 20-35°	R	DC h8

Workpiece material group suitability, starting values for cutting speed (m/min) and feed Alpha Code. Tables with feed per revolution can be found starting from page 71.

P1.1 ■ 36 E	P1.2 ■ 40 E	P1.3 ■ 41 E	P2.1 ■ 31 E	P2.2 ■ 27 C	P2.3 ■ 24 C	P3.1 ■ 21 C	P3.2 ■ 17 C	P3.3 ■ 14 C	P4.1 ■ 12 C	P4.2 ■ 10 C	P4.3 ■ 9 B	M1.1 ■ 22 C	M1.2 ■ 19 C
M2.1 ■ 20 C	M2.2 ■ 16 C	M3.1 ■ 10 D	M3.2 ■ 9 D	M3.3 ■ 8 D	M4.1 ■ 10 B	N1.1 ■ 33 E	N1.2 ■ 25 E	N1.3 ■ 17 E	N2.1 ■ 46 D	N2.2 ■ 42 D	N2.3 ■ 30 D	N3.1 ■ 56 D	N3.2 ■ 33 E
N3.3 ■ 17 D	N4.1 ■ 30 F	N4.2 ■ 35 E	N4.3 ■ 17 D	S1.1 ■ 27 C	S1.2 ■ 12 B	S1.3 ■ 7 A	S2.1 ■ 11 C	S2.2 ■ 6 A	S3.1 ■ 8 C	S3.2 ■ 4 A	S4.1 ■ 6 C	S4.2 ■ 3 A	

Sheet Metal Drill.

Product	DC	DC	DC	LCF	OAL	DCON MS
	(inch)	(mm)	(inch)			
A1233/32S	3/32	2.38	0.0937	14.0	43.0	2.38
A1232.5S	–	2.50	0.0984	14.0	43.0	2.50
A1233.0S	–	3.00	0.1181	16.0	46.0	3.00
A1231/8S	1/8	3.18	0.1252	18.0	49.0	3.18
A1233.2S	–	3.20	0.1260	18.0	49.0	3.20
A1233.3S	–	3.30	0.1299	18.0	49.0	3.30
A1233.5S	–	3.50	0.1378	18.0	52.0	3.50
A1233.7S	–	3.70	0.1457	18.0	52.0	3.70
A1235/32S	5/32	3.97	0.1563	18.0	55.0	3.97
A1234.0S	–	4.00	0.1575	18.0	55.0	4.00
A1234.1S	–	4.10	0.1614	18.0	55.0	4.10
A1234.2S	–	4.20	0.1654	18.0	55.0	4.20
A1234.5S	–	4.50	0.1772	18.0	58.0	4.50
A1233/16S	3/16	4.76	0.1875	18.0	62.0	4.76
A1234.8S	–	4.80	0.1890	18.0	62.0	4.80
A1234.9S	–	4.90	0.1929	18.0	62.0	4.90
A1235.0S	–	5.00	0.1969	18.0	62.0	5.00
A1235.5S	–	5.50	0.2165	18.0	66.0	5.50
A1237/32S	7/32	5.56	0.2188	18.0	66.0	5.56
A1236.0S	–	6.00	0.2362	18.0	66.0	6.00
A1231/4S	1/4	6.35	0.2500	19.0	70.0	6.35

A119



HSS Double Ended Stub Drill, Steam Tempered Finish

A short double-ended drill designed for drilling holes through sheet metal. Possible to use both ends, giving twice the tool life. A 120° conventional point to aid self-centering. Suitable for drilling in many materials. Steam tempered finish retains cutting fluid and prevents chip to tool welding.

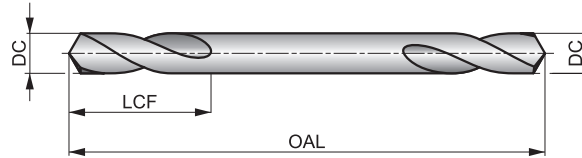

HSS	DIN 1897	1.25xD
120°	ST	
λ 20-35°	R	DC h8

Workpiece material group suitability, starting values for cutting speed (m/min) and feed Alpha Code. Tables with feed per revolution can be found starting from page 71.

P1.1 ■ 31 C	P1.2 ■ 34 C	P1.3 ■ 35 C	P2.1 ■ 26 C	P2.2 ■ 23 C	P2.3 ■ 20 C	P3.1 ■ 12 C	P3.2 ■ 9 C	P3.3 ■ 8 C	P4.1 ■ 7 C	P4.2 ■ 6 C	P4.3 ■ 5 A	M1.1 ■ 21 A	M1.2 ■ 17 A
M2.1 ■ 18 A	M2.2 ■ 15 A	M3.1 ■ 8 C	M3.2 ■ 7 C	M3.3 ■ 6 C	M4.1 ■ 10 A	N1.1 ■ 33 C	N1.2 ■ 25 C	N1.3 ■ 17 C	N2.1 ■ 46 C	N2.2 ■ 42 C	N2.3 ■ 30 C	N3.1 ■ 56 C	N3.2 ■ 33 C
N3.3 ■ 17 A	N4.1 ■ 30 I	N4.2 ■ 35 C	S1.1 ■ 27 A	S1.2 ■ 12 A	S1.3 ■ 17 A	S2.1 ■ 5 C	S2.2 ■ 4 C	S3.1 ■ 4 C	S3.2 ■ 3 C	S4.1 ■ 3 C	S4.2 ■ 2 C		

Sheet Metal Drill.

Product	DC	DC	LCF	OAL	DCON MS
	(mm)	(inch)			
A1193.3	3.30	0.1299	11.0	49.0	3.30
A1193.6	3.60	0.1417	12.0	52.0	3.60
A1194.1	4.10	0.1614	14.0	55.0	4.10
A1194.2	4.20	0.1654	14.0	55.0	4.20
A1194.9	4.90	0.1929	17.0	62.0	4.90
A1195.1	5.10	0.2008	17.0	62.0	5.10

A723



HSS-E (5% Cobalt) Spot Weld Drill, Bronze Tempered Finish

Drill with specially designed lip and spur point to remove or "drill out" spot welded areas, commonly for removing welds in a vehicle repair shop. Short flute length makes it more sturdy and less prone to shattering when being used in a hand-held device. The bronze finish is a thin oxide layer and an indication for Cobalt.

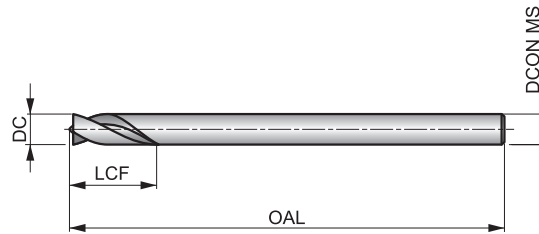

HSS-E		1×D
	DC h8	

Workpiece material group suitability, starting values for cutting speed (m/min) and feed Alpha Code. Tables with feed per revolution can be found starting from page 71.

P1.1 ■ 33 D	P1.2 ■ 37 D	P1.3 ■ 38 D	P2.1 ■ 28 D	P2.2 ■ 25 C	P3.1 ■ 20 C	P3.2 ■ 20 C	P4.1 ■ 20 C
-----------------------	-----------------------	-----------------------	-----------------------	-----------------------	-----------------------	-----------------------	-----------------------

Product	DC	DC	LCF	OAL	DCON MS
	(mm)	(inch)	(mm)	(mm)	(mm)
A7236.0X66	6.00	0.2362	18.0	66.0	6.00
A7236.0X93	6.00	0.2362	18.0	93.0	6.00
A7238.0X79	8.00	0.3150	24.0	79.0	8.00
A7238.0X117	8.00	0.3150	24.0	117.0	8.00

A170



HSS Reduced Shank Drill, Steam Tempered Finish

A 1/2 inch parallel shank allows this drill, even with a large cutting diameter, to be clamped in conventional, hand-held power tools. A 118° point makes regrinding easy. Steam tempered finish retains cutting fluid and prevents chip to tool welding. Suitable for drilling many materials.

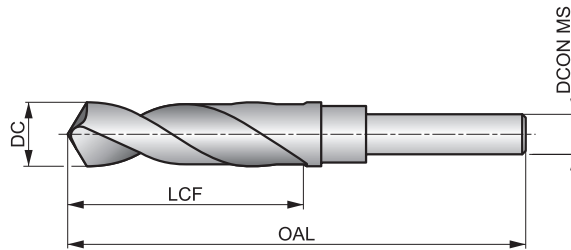

HSS	DORMER	4xD
118°	ST	
λ 20-35°	R	DC h8

Workpiece material group suitability, starting values for cutting speed (m/min) and feed Alpha Code. Tables with feed per revolution can be found starting from page 71.

P1.1 ■ 33 H	P1.2 ■ 37 H	P1.3 ■ 38 H	P2.1 ■ 28 H	P2.2 ■ 25 F	P2.3 ■ 22 D	P3.1 ■ 19 E	P3.2 ■ 15 E	P3.3 ■ 13 D	P4.1 ■ 11 E	P4.2 ■ 10 D	P4.3 ■ 8 C	M1.1 ■ 21 D	M1.2 ■ 17 D
M2.1 ■ 18 D	M2.2 ■ 15 D	M3.1 ■ 8 F	M3.2 ■ 7 F	M3.3 ■ 6 F	M4.1 ■ 7 B	K1.1 ■ 27 H	K1.2 ■ 20 E	K1.3 ■ 15 E	K2.1 ■ 23 D	K2.2 ■ 19 D	K2.3 ■ 15 D	K3.1 ■ 21 D	K3.2 ■ 16 D
K3.3 ■ 13 D	K4.1 ■ 19 D	K4.2 ■ 14 D	K4.3 ■ 11 D	K4.4 ■ 9 D	K4.5 ■ 8 D	K5.1 ■ 22 D	K5.2 ■ 16 D	K5.3 ■ 13 D	N1.1 ■ 33 I	N1.2 ■ 25 I	N1.3 ■ 17 H	N2.1 ■ 42 G	N2.2 ■ 37 G
N2.3 ■ 27 G	N3.1 ■ 56 G	N3.2 ■ 33 H	N3.3 ■ 17 F	N4.1 ■ 30 I	N4.2 ■ 28 G	N4.3 ■ 14 E	S1.1 ■ 17 E	S1.2 ■ 9 C	S1.3 ■ 5 A	S2.1 ■ 5 D	S2.2 ■ 4 A	S3.1 ■ 4 D	S3.2 ■ 3 A
S4.1 ■ 3 D	S4.2 ■ 2 A												

Product	DC	DC	DC	LCF	OAL	LCF	OAL	DCON MS
	(inch)	(mm)	(inch)	(inch)	(inch)	(mm)	(mm)	
A17013.0	–	13.00	0.5118	–	–	83.0	156.0	12,7
A17033/64	33/64	13.10	0.5156	3.1/8	6"	–	–	12,7
A17017/32	17/32	13.49	0.5313	3.1/8	6"	–	–	12,7
A17013.5	–	13.50	0.5315	–	–	83.0	156.0	12,7
A17035/64	35/64	13.89	0.5469	3.1/8	6"	–	–	12,7
A17014.0	–	14.00	0.5512	–	–	83.0	156.0	12,7
A1709/16	9/16	14.29	0.5625	3.1/8	6"	–	–	12,7
A17014.5	–	14.50	0.5709	–	–	83.0	156.0	12,7
A17037/64	37/64	14.68	0.5781	3.1/8	6"	–	–	12,7
A17015.0	–	15.00	0.5906	–	–	83.0	156.0	12,7
A17019/32	19/32	15.08	0.5938	3.1/8	6"	–	–	12,7
A17039/64	39/64	15.48	0.6094	3.1/8	6"	–	–	12,7
A17015.5	–	15.50	0.6102	–	–	83.0	156.0	12,7
A1705/8	5/8	15.88	0.6250	3.1/8	6"	–	–	12,7
A17016.0	–	16.00	0.6299	–	–	84.0	157.0	12,7
A17041/64	41/64	16.27	0.6406	3.1/8	6"	–	–	12,7
A17016.5	–	16.50	0.6496	–	–	84.0	157.0	12,7
A17021/32	21/32	16.67	0.6563	3.1/8	6"	–	–	12,7
A17017.0	–	17.00	0.6693	–	–	84.0	157.0	12,7
A17043/64	43/64	17.07	0.6719	3.1/8	6"	–	–	12,7
A17011/16	11/16	17.46	0.6875	3.1/8	6"	–	–	12,7
A17017.5	–	17.50	0.6890	–	–	84.0	157.0	12,7
A17045/64	45/64	17.86	0.7031	3.1/8	6"	–	–	12,7
A17018.0	–	18.00	0.7087	–	–	84.0	157.0	12,7



Product	DC	DC	DC	LCF	OAL	LCF	OAL	DCON MS
	(inch)	(mm)	(inch)	(inch)	(inch)	(mm)	(mm)	(mm)
A17023/32	23/32	18.26	0.7188	3.1/8	6"	—	—	12,7
A17018.5	—	18.50	0.7283	—	—	84.0	157.0	12,7
A17047/64	47/64	18.65	0.7344	3.1/8	6"	—	—	12,7
A17019.0	—	19.00	0.7480	—	—	84.0	157.0	12,7
A1703/4	3/4	19.05	0.7500	3.1/8	6"	—	—	12,7
A17049/64	49/64	19.45	0.7656	3"	6"	—	—	12,7
A17019.5	—	19.50	0.7677	—	—	81.0	158.0	12,7
A17025/32	25/32	19.84	0.7813	3"	6"	—	—	12,7
A17020.0	—	20.00	0.7874	—	—	81.0	158.0	12,7
A17051/64	51/64	20.24	0.7969	3"	6"	—	—	12,7
A17013/16	13/16	20.64	0.8125	3"	6"	—	—	12,7
A17021.0	—	21.00	0.8268	—	—	82.0	158.0	12,7
A17053/64	53/64	21.03	0.8281	3"	6"	—	—	12,7
A17027/32	27/32	21.43	0.8437	3"	6"	—	—	12,7
A17055/64	55/64	21.83	0.8594	3"	6"	—	—	12,7
A17022.0	—	22.00	0.8661	—	—	82.0	158.0	12,7
A1707/8	7/8	22.22	0.8750	3"	6"	—	—	12,7
A17057/64	57/64	22.62	0.8906	3"	6"	—	—	12,7
A17023.0	—	23.00	0.9055	—	—	82.0	158.0	12,7
A17029/32	29/32	23.02	0.9063	3"	6"	—	—	12,7
A17059/64	59/64	23.42	0.9219	3"	6"	—	—	12,7
A17015/16	15/16	23.81	0.9375	3"	6"	—	—	12,7
A17024.0	—	24.00	0.9449	—	—	83.0	159.0	12,7
A17061/64	61/64	24.21	0.9531	3"	6"	—	—	12,7
A17031/32	31/32	24.61	0.9688	3"	6"	—	—	12,7
A17025.0	—	25.00	0.9843	—	—	83.0	159.0	12,7
A17063/64	63/64	25.00	0.9844	3"	6"	—	—	12,7
A1701	1"	25.40	1.0000	3"	6"	—	—	12,7
A1701.1/32	1.1/32	26.19	1.0313	3"	6"	—	—	12,7
A1701.1/16	1.1/16	26.99	1.0625	3"	6"	—	—	12,7
A1701.7/64	1.7/64	28.18	1.1094	3"	6"	—	—	12,7
A1701.1/8	1.1/8	28.58	1.1250	3"	6"	—	—	12,7
A1701.9/64	1.9/64	28.97	1.1406	3"	6"	—	—	12,7
A1701.5/32	1.5/32	29.37	1.1563	3"	6"	—	—	12,7
A1701.3/16	1.3/16	30.16	1.1875	3"	6"	—	—	12,7
A1701.7/32	1.7/32	30.96	1.2188	3"	6"	—	—	12,7
A1701.1/4	1.1/4	31.75	1.2500	3"	6"	—	—	12,7
A1701.5/16	1.5/16	33.34	1.3125	3"	6"	—	—	12,7
A1701.3/8	1.3/8	34.93	1.3750	3"	6"	—	—	12,7
A1701.7/16	1.7/16	36.51	1.4375	3"	6"	—	—	12,7
A1701.1/2	1.1/2	38.10	1.5000	3"	6"	—	—	12,7



A130



HSS Taper Shank Drill, Steam Tempered Finish

Versatile drill with larger diameters - up to 50.80mm (2 inches). Tapered shank provides a better grip for holding it in the machine. Conventional 118° point provides strength and makes it easy to regrind. Steam tempered finish retains cutting fluid and prevents chip to tool welding. Suitable for drilling many materials.

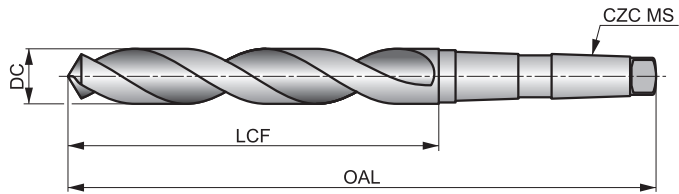

HSS	DIN 345	4xD
118°	ST	
λ 20-35°		DC h8

Workpiece material group suitability, starting values for cutting speed (m/min) and feed Alpha Code. Tables with feed per revolution can be found starting from page 71.

P1.1 ■ 33 I	P1.2 ■ 37 I	P1.3 ■ 38 I	P2.1 ■ 28 I	P2.2 ■ 25 F	P2.3 ■ 22 E	P3.1 ■ 18 F	P3.2 ■ 14 F	P3.3 ■ 12 E	P4.1 ■ 11 F	P4.2 ■ 9 E	P4.3 ■ 7 D	M1.1 ■ 21 E	M1.2 ■ 17 E
M2.1 ■ 18 E	M2.2 ■ 15 E	M3.1 ■ 10 G	M3.2 ■ 9 G	M3.3 ■ 8 G	M4.1 ■ 10 C	K1.1 ■ 30 I	K1.2 ■ 22 E	K1.3 ■ 17 E	K2.1 ■ 25 E	K2.2 ■ 20 E	K2.3 ■ 16 E	K3.1 ■ 22 E	K3.2 ■ 17 E
K3.3 ■ 13 E	K4.1 ■ 20 E	K4.2 ■ 15 E	K4.3 ■ 11 E	K4.4 ■ 10 E	K4.5 ■ 8 E	K5.1 ■ 23 E	K5.2 ■ 17 E	K5.3 ■ 13 E	N1.1 ■ 26 J	N1.2 ■ 20 J	N1.3 ■ 13 I	N2.1 ■ 43 H	N2.2 ■ 39 H
N2.3 ■ 28 H	N3.1 ■ 59 H	N3.2 ■ 35 I	N3.3 ■ 18 F	N4.1 ■ 30 K	N4.2 ■ 28 J	N4.3 ■ 14 H	S1.1 ■ 23 F	S1.2 ■ 13 D	S1.3 ■ 7 B	S2.1 ■ 9 E	S2.2 ■ 6 A	S3.1 ■ 7 E	S3.2 ■ 4 A
S4.1 ■ 5 E	S4.2 ■ 3 A												

DC > 14mm Point Thinned.

Product	DC	DC	DC	LCF	OAL	CZC MS
	(inch)	(mm)	(inch)	(mm)	(mm)	
A1303.0	—	3.00	0.1181	33.0	114.0	MK 1
A1301/8	1/8	3.18	0.1252	36.0	117.0	MK 1
A1303.2	—	3.20	0.1260	36.0	117.0	MK 1
A1303.25	—	3.25	0.1280	36.0	117.0	MK 1
A1303.3	—	3.30	0.1299	36.0	117.0	MK 1
A1303.5	—	3.50	0.1378	39.0	120.0	MK 1
A1309/64	9/64	3.57	0.1406	39.0	120.0	MK 1
A1303.75	—	3.75	0.1476	39.0	120.0	MK 1
A1305/32	5/32	3.97	0.1563	43.0	124.0	MK 1
A1304.0	—	4.00	0.1575	43.0	124.0	MK 1
A1304.1	—	4.10	0.1614	43.0	124.0	MK 1
A1304.2	—	4.20	0.1654	43.0	124.0	MK 1
A1304.25	—	4.25	0.1673	43.0	124.0	MK 1
A13011/64	11/64	4.37	0.1719	47.0	128.0	MK 1
A1304.5	—	4.50	0.1772	47.0	128.0	MK 1
A1304.75	—	4.75	0.1870	52.0	128.0	MK 1
A1303/16	3/16	4.76	0.1875	52.0	133.0	MK 1
A1304.8	—	4.80	0.1890	52.0	133.0	MK 1
A1304.9	—	4.90	0.1929	52.0	133.0	MK 1
A1305.0	—	5.00	0.1969	52.0	133.0	MK 1
A1305.1	—	5.10	0.2008	52.0	133.0	MK 1
A13013/64	13/64	5.16	0.2031	52.0	133.0	MK 1
A1305.2	—	5.20	0.2047	52.0	133.0	MK 1



Product	DC	DC	DC	LCF	OAL	CZC MS
	(inch)	(mm)	(inch)	(mm)	(mm)	
A1305.25	–	5.25	0.2067	52.0	133.0	MK 1
A1305.4	–	5.40	0.2126	57.0	138.0	MK 1
A1305.5	–	5.50	0.2165	57.0	138.0	MK 1
A1307/32	7/32	5.56	0.2188	57.0	138.0	MK 1
A1305.7	–	5.70	0.2244	57.0	138.0	MK 1
A1305.75	–	5.75	0.2264	57.0	138.0	MK 1
A1305.8	–	5.80	0.2283	57.0	138.0	MK 1
A1305.9	–	5.90	0.2323	57.0	138.0	MK 1
A13015/64	15/64	5.95	0.2344	57.0	138.0	MK 1
A1306.0	–	6.00	0.2362	57.0	138.0	MK 1
A1306.1	–	6.10	0.2402	63.0	144.0	MK 1
A1306.2	–	6.20	0.2441	63.0	144.0	MK 1
A1306.25	–	6.25	0.2461	63.0	144.0	MK 1
A1306.3	–	6.30	0.2480	63.0	144.0	MK 1
A1301/4	1/4	6.35	0.2500	63.0	144.0	MK 1
A1306.4	–	6.40	0.2520	63.0	144.0	MK 1
A1306.5	–	6.50	0.2559	63.0	144.0	MK 1
A1306.6	–	6.60	0.2598	63.0	144.0	MK 1
A1306.7	–	6.70	0.2638	63.0	144.0	MK 1
A13017/64	17/64	6.75	0.2656	69.0	150.0	MK 1
A1306.75	–	6.75	0.2657	69.0	150.0	MK 1
A1306.8	–	6.80	0.2677	69.0	150.0	MK 1
A1306.9	–	6.90	0.2717	69.0	150.0	MK 1
A1307.0	–	7.00	0.2756	69.0	150.0	MK 1
A1309/32	9/32	7.14	0.2813	69.0	150.0	MK 1
A1307.2	–	7.20	0.2835	69.0	150.0	MK 1
A1307.25	–	7.25	0.2854	69.0	150.0	MK 1
A1307.3	–	7.30	0.2874	69.0	150.0	MK 1
A1307.4	–	7.40	0.2913	69.0	150.0	MK 1
A1307.5	–	7.50	0.2953	69.0	150.0	MK 1
A13019/64	19/64	7.54	0.2969	75.0	156.0	MK 1
A1307.7	–	7.70	0.3031	75.0	156.0	MK 1
A1307.75	–	7.75	0.3051	75.0	156.0	MK 1
A1307.8	–	7.80	0.3071	75.0	156.0	MK 1
A1307.9	–	7.90	0.3110	75.0	156.0	MK 1
A1305/16	5/16	7.94	0.3125	75.0	156.0	MK 1
A1308.0	–	8.00	0.3150	75.0	156.0	MK 1
A1308.1	–	8.10	0.3189	75.0	156.0	MK 1
A1308.2	–	8.20	0.3228	75.0	156.0	MK 1
A1308.25	–	8.25	0.3248	75.0	156.0	MK 1
A1308.3	–	8.30	0.3268	75.0	156.0	MK 1
A13021/64	21/64	8.33	0.3281	75.0	156.0	MK 1
A1308.4	–	8.40	0.3307	75.0	156.0	MK 1
A1308.5	–	8.50	0.3346	75.0	156.0	MK 1
A1308.6	–	8.60	0.3386	81.0	162.0	MK 1
A1308.7	–	8.70	0.3425	81.0	162.0	MK 1
A13011/32	11/32	8.73	0.3438	81.0	162.0	MK 1
A1308.75	–	8.75	0.3445	81.0	162.0	MK 1
A1308.8	–	8.80	0.3465	81.0	162.0	MK 1
A1308.9	–	8.90	0.3504	81.0	162.0	MK 1
A1309.0	–	9.00	0.3543	81.0	162.0	MK 1
A1309.1	–	9.10	0.3583	81.0	162.0	MK 1
A13023/64	23/64	9.13	0.3594	81.0	162.0	MK 1
A1309.2	–	9.20	0.3622	81.0	162.0	MK 1
A1309.25	–	9.25	0.3642	81.0	162.0	MK 1
A1309.3	–	9.30	0.3661	81.0	162.0	MK 1
A1309.5	–	9.50	0.3740	81.0	162.0	MK 1
A1303/8	3/8	9.52	0.3750	87.0	168.0	MK 1
A1309.6	–	9.60	0.3780	87.0	168.0	MK 1
A1309.7	–	9.70	0.3819	87.0	168.0	MK 1
A1309.75	–	9.75	0.3839	87.0	168.0	MK 1
A1309.8	–	9.80	0.3858	87.0	168.0	MK 1



Product	DC	DC	DC	LCF	OAL	CZC MS
	(inch)	(mm)	(inch)	(mm)	(mm)	
A1309.9	–	9.90	0.3898	87.0	168.0	MK 1
A13025/64	25/64	9.92	0.3906	87.0	168.0	MK 1
A13010.0	–	10.00	0.3937	87.0	168.0	MK 1
A13010.1	–	10.10	0.3976	87.0	168.0	MK 1
A13010.2	–	10.20	0.4016	87.0	168.0	MK 1
A13010.25	–	10.25	0.4035	87.0	168.0	MK 1
A13010.3	–	10.30	0.4055	87.0	168.0	MK 1
A13013/32	13/32	10.32	0.4063	87.0	168.0	MK 1
A13010.5	–	10.50	0.4134	87.0	168.0	MK 1
A13027/64	27/64	10.72	0.4219	94.0	175.0	MK 1
A13010.75	–	10.75	0.4232	94.0	175.0	MK 1
A13010.8	–	10.80	0.4252	94.0	175.0	MK 1
A13010.9	–	10.90	0.4291	94.0	175.0	MK 1
A13011.0	–	11.00	0.4331	94.0	175.0	MK 1
A13011.1	–	11.10	0.4370	94.0	175.0	MK 1
A1307/16	7/16	11.11	0.4375	94.0	175.0	MK 1
A13011.2	–	11.20	0.4409	94.0	175.0	MK 1
A13011.25	–	11.25	0.4429	94.0	175.0	MK 1
A13011.3	–	11.30	0.4449	94.0	175.0	MK 1
A13011.4	–	11.40	0.4488	94.0	175.0	MK 1
A13011.5	–	11.50	0.4528	94.0	175.0	MK 1
A13029/64	29/64	11.51	0.4531	94.0	175.0	MK 1
A13011.6	–	11.60	0.4567	94.0	175.0	MK 1
A13011.7	–	11.70	0.4606	94.0	175.0	MK 1
A13011.75	–	11.75	0.4626	94.0	175.0	MK 1
A13011.8	–	11.80	0.4646	94.0	175.0	MK 1
A13011.9	–	11.90	0.4685	101.0	182.0	MK 1
A13015/32	15/32	11.91	0.4688	101.0	182.0	MK 1
A13012.0	–	12.00	0.4724	101.0	182.0	MK 1
A13012.1	–	12.10	0.4764	101.0	182.0	MK 1
A13012.2	–	12.20	0.4803	101.0	182.0	MK 1
A13012.25	–	12.25	0.4823	101.0	182.0	MK 1
A13031/64	31/64	12.30	0.4844	101.0	182.0	MK 1
A13012.3	–	12.30	0.4843	101.0	182.0	MK 1
A13012.4	–	12.40	0.4882	101.0	182.0	MK 1
A13012.5	–	12.50	0.4921	101.0	182.0	MK 1
A13012.6	–	12.60	0.4961	101.0	182.0	MK 1
A13012.7	–	12.70	0.5000	101.0	182.0	MK 1
A1301/2	1/2	12.70	0.5000	101.0	182.0	MK 1
A13012.75	–	12.75	0.5020	101.0	182.0	MK 1
A13012.8	–	12.80	0.5039	101.0	182.0	MK 1
A13012.9	–	12.90	0.5079	101.0	182.0	MK 1
A13013.0	–	13.00	0.5118	101.0	182.0	MK 1
A13033/64	33/64	13.10	0.5156	101.0	182.0	MK 1
A13013.2	–	13.20	0.5197	101.0	182.0	MK 1
A13013.25	–	13.25	0.5217	108.0	189.0	MK 1
A13017/32	17/32	13.49	0.5313	108.0	189.0	MK 1
A13013.5	–	13.50	0.5315	108.0	189.0	MK 1
A13013.6	–	13.60	0.5354	108.0	189.0	MK 1
A13013.7	–	13.70	0.5394	108.0	189.0	MK 1
A13013.75	–	13.75	0.5413	108.0	189.0	MK 1
A13013.8	–	13.80	0.5433	108.0	189.0	MK 1
A13035/64	35/64	13.89	0.5469	108.0	189.0	MK 1
A13013.9	–	13.90	0.5472	108.0	189.0	MK 1
A13014.0	–	14.00	0.5512	108.0	189.0	MK 1
A13014.1	–	14.10	0.5551	114.0	212.0	MK 2
A13014.2	–	14.20	0.5591	114.0	212.0	MK 2
A13014.25	–	14.25	0.5610	114.0	212.0	MK 2
A1309/16	9/16	14.29	0.5625	114.0	212.0	MK 2
A13014.3	–	14.30	0.5630	114.0	212.0	MK 2
A13014.4	–	14.40	0.5669	114.0	212.0	MK 2
A13014.5	–	14.50	0.5709	114.0	212.0	MK 2



Product	DC	DC	DC	LCF	OAL	CZC MS
	(inch)	(mm)	(inch)	(mm)	(mm)	
A13014.6	–	14.60	0.5748	114.0	212.0	MK 2
A13037/64	37/64	14.68	0.5781	114.0	212.0	MK 2
A13014.7	–	14.70	0.5787	114.0	212.0	MK 2
A13014.75	–	14.75	0.5807	114.0	212.0	MK 2
A13014.8	–	14.80	0.5827	114.0	212.0	MK 2
A13014.9	–	14.90	0.5866	114.0	212.0	MK 2
A13015.0	–	15.00	0.5906	114.0	212.0	MK 2
A13019/32	19/32	15.08	0.5938	120.0	218.0	MK 2
A13015.1	–	15.10	0.5945	120.0	218.0	MK 2
A13015.2	–	15.20	0.5984	120.0	218.0	MK 2
A13015.25	–	15.25	0.6004	120.0	218.0	MK 2
A13039/64	39/64	15.48	0.6094	120.0	218.0	MK 2
A13015.5	–	15.50	0.6102	120.0	218.0	MK 2
A13015.7	–	15.70	0.6181	120.0	218.0	MK 2
A13015.75	–	15.75	0.6201	120.0	218.0	MK 2
A13015.8	–	15.80	0.6220	120.0	218.0	MK 2
A1305/8	5/8	15.88	0.6250	120.0	218.0	MK 2
A13015.9	–	15.90	0.6260	120.0	218.0	MK 2
A13016.0	–	16.00	0.6299	120.0	218.0	MK 2
A13016.1	–	16.10	0.6339	125.0	223.0	MK 2
A13016.2	–	16.20	0.6378	125.0	223.0	MK 2
A13016.25	–	16.25	0.6398	125.0	223.0	MK 2
A13041/64	41/64	16.27	0.6406	125.0	223.0	MK 2
A13016.5	–	16.50	0.6496	125.0	223.0	MK 2
A13021/32	21/32	16.67	0.6563	125.0	223.0	MK 2
A13016.75	–	16.75	0.6594	125.0	223.0	MK 2
A13017.0	–	17.00	0.6693	125.0	223.0	MK 2
A13043/64	43/64	17.07	0.6719	130.0	228.0	MK 2
A13017.25	–	17.25	0.6791	130.0	228.0	MK 2
A13011/16	11/16	17.46	0.6875	130.0	228.0	MK 2
A13017.5	–	17.50	0.6890	130.0	228.0	MK 2
A13017.75	–	17.75	0.6988	130.0	228.0	MK 2
A13045/64	45/64	17.86	0.7031	130.0	228.0	MK 2
A13018.0	–	18.00	0.7087	130.0	228.0	MK 2
A13018.25	–	18.25	0.7185	135.0	233.0	MK 2
A13023/32	23/32	18.26	0.7188	135.0	233.0	MK 2
A13018.5	–	18.50	0.7283	135.0	233.0	MK 2
A13047/64	47/64	18.65	0.7344	135.0	233.0	MK 2
A13018.75	–	18.75	0.7382	135.0	233.0	MK 2
A13019.0	–	19.00	0.7480	135.0	233.0	MK 2
A1303/4	3/4	19.05	0.7500	140.0	238.0	MK 2
A13019.25	–	19.25	0.7579	140.0	238.0	MK 2
A13049/64	49/64	19.45	0.7656	140.0	238.0	MK 2
A13019.5	–	19.50	0.7677	140.0	238.0	MK 2
A13019.75	–	19.75	0.7776	140.0	238.0	MK 2
A13025/32	25/32	19.84	0.7813	140.0	238.0	MK 2
A13020.0	–	20.00	0.7874	140.0	238.0	MK 2
A13051/64	51/64	20.24	0.7969	145.0	243.0	MK 2
A13020.25	–	20.25	0.7972	145.0	243.0	MK 2
A13020.4	–	20.40	0.8031	145.0	243.0	MK 2
A13020.5	–	20.50	0.8071	145.0	243.0	MK 2
A13013/16	13/16	20.64	0.8125	145.0	243.0	MK 2
A13020.75	–	20.75	0.8169	145.0	243.0	MK 2
A13021.0	–	21.00	0.8268	145.0	243.0	MK 2
A13053/64	53/64	21.03	0.8281	145.0	243.0	MK 2
A13021.25	–	21.25	0.8366	150.0	248.0	MK 2
A13027/32	27/32	21.43	0.8437	150.0	248.0	MK 2
A13021.5	–	21.50	0.8465	150.0	248.0	MK 2
A13021.75	–	21.75	0.8563	150.0	248.0	MK 2
A13055/64	55/64	21.83	0.8594	150.0	248.0	MK 2
A13022.0	–	22.00	0.8661	150.0	248.0	MK 2
A1307/8	7/8	22.22	0.8750	150.0	248.0	MK 2



Product	DC	DC	DC	LCF	OAL	CZC MS
	(inch)	(mm)	(inch)	(mm)	(mm)	
A13022.25	—	22.25	0.8760	150.0	248.0	MK 2
A13022.5	—	22.50	0.8858	155.0	253.0	MK 2
A13057/64	57/64	22.62	0.8906	155.0	253.0	MK 2
A13022.75	—	22.75	0.8957	155.0	253.0	MK 2
A13023.0	—	23.00	0.9055	155.0	253.0	MK 2
A13029/32	29/32	23.02	0.9063	155.0	253.0	MK 2
A13023.25	—	23.25	0.9154	155.0	276.0	MK 3
A13059/64	59/64	23.42	0.9219	155.0	276.0	MK 3
A13023.5	—	23.50	0.9252	155.0	276.0	MK 3
A13023.75	—	23.75	0.9350	160.0	281.0	MK 3
A13015/16	15/16	23.81	0.9375	160.0	281.0	MK 3
A13024.0	—	24.00	0.9449	160.0	281.0	MK 3
A13061/64	61/64	24.21	0.9531	160.0	281.0	MK 3
A13024.25	—	24.25	0.9547	160.0	281.0	MK 3
A13024.5	—	24.50	0.9646	160.0	281.0	MK 3
A13031/32	31/32	24.61	0.9688	160.0	281.0	MK 3
A13024.75	—	24.75	0.9744	160.0	281.0	MK 3
A13025.0	—	25.00	0.9843	160.0	281.0	MK 3
A13063/64	63/64	25.00	0.9844	160.0	286.0	MK 3
A13025.25	—	25.25	0.9941	165.0	286.0	MK 3
A1301	1"	25.40	1.0000	165.0	286.0	MK 3
A13025.5	—	25.50	1.0039	165.0	286.0	MK 3
A13025.75	—	25.75	1.0138	165.0	286.0	MK 3
A13026.0	—	26.00	1.0236	165.0	286.0	MK 3
A13026.25	—	26.25	1.0335	165.0	286.0	MK 3
A13026.5	—	26.50	1.0433	165.0	286.0	MK 3
A13026.75	—	26.75	1.0531	170.0	291.0	MK 3
A1301.1/16	1.1/16	26.99	1.0625	170.0	291.0	MK 3
A13027.0	—	27.00	1.0630	170.0	291.0	MK 3
A13027.25	—	27.25	1.0728	170.0	291.0	MK 3
A13027.5	—	27.50	1.0827	170.0	291.0	MK 3
A13027.75	—	27.75	1.0925	170.0	291.0	MK 3
A13028.0	—	28.00	1.1024	170.0	291.0	MK 3
A13028.25	—	28.25	1.1122	175.0	296.0	MK 3
A13028.5	—	28.50	1.1220	175.0	296.0	MK 3
A1301.1/8	1.1/8	28.58	1.1250	175.0	296.0	MK 3
A13028.75	—	28.75	1.1319	175.0	296.0	MK 3
A13029.0	—	29.00	1.1417	175.0	296.0	MK 3
A13029.25	—	29.25	1.1516	175.0	296.0	MK 3
A1301.5/32	1.5/32	29.37	1.1563	175.0	296.0	MK 3
A13029.5	—	29.50	1.1614	175.0	296.0	MK 3
A13029.75	—	29.75	1.1713	175.0	296.0	MK 3
A13030.0	—	30.00	1.1811	175.0	296.0	MK 3
A1301.3/16	1.3/16	30.16	1.1875	180.0	301.0	MK 3
A13030.25	—	30.25	1.1909	180.0	301.0	MK 3
A13030.5	—	30.50	1.2008	180.0	301.0	MK 3
A13030.75	—	30.75	1.2106	180.0	301.0	MK 3
A1301.7/32	1.7/32	30.96	1.2188	180.0	301.0	MK 3
A13031.0	—	31.00	1.2205	180.0	301.0	MK 3
A13031.25	—	31.25	1.2303	180.0	301.0	MK 3
A13031.5	—	31.50	1.2402	180.0	301.0	MK 3
A13031.75	—	31.75	1.2500	185.0	306.0	MK 3
A1301.1/4	1.1/4	31.75	1.2500	185.0	306.0	MK 3
A13032.0	—	32.00	1.2598	185.0	334.0	MK 4
A13032.5	—	32.50	1.2795	185.0	334.0	MK 4
A1301.9/32	1.9/32	32.54	1.2813	185.0	334.0	MK 4
A13033.0	—	33.00	1.2992	185.0	334.0	MK 4
A1301.5/16	1.5/16	33.34	1.3125	185.0	334.0	MK 4
A13033.5	—	33.50	1.3189	185.0	334.0	MK 4
A13034.0	—	34.00	1.3386	190.0	339.0	MK 4
A1301.11/32	1.11/32	34.13	1.3438	190.0	339.0	MK 4
A13034.5	—	34.50	1.3583	190.0	339.0	MK 4



Product	DC	DC	DC	LCF	OAL	CZC MS
	(inch)	(mm)	(inch)	(mm)	(mm)	
A1301.3/8	1.3/8	34.93	1.3750	190.0	339.0	MK 4
A13035.0	–	35.00	1.3780	190.0	339.0	MK 4
A13035.5	–	35.50	1.3976	190.0	339.0	MK 4
A1301.13/32	1.13/32	35.72	1.4063	195.0	344.0	MK 4
A13036.0	–	36.00	1.4173	195.0	344.0	MK 4
A13036.5	–	36.50	1.4370	195.0	344.0	MK 4
A1301.7/16	1.7/16	36.51	1.4375	195.0	344.0	MK 4
A13037.0	–	37.00	1.4567	195.0	344.0	MK 4
A13037.5	–	37.50	1.4764	195.0	344.0	MK 4
A13038.0	–	38.00	1.4961	200.0	349.0	MK 4
A1301.1/2	1.1/2	38.10	1.5000	200.0	349.0	MK 4
A13038.5	–	38.50	1.5157	200.0	349.0	MK 4
A13039.0	–	39.00	1.5354	200.0	349.0	MK 4
A13039.5	–	39.50	1.5551	200.0	349.0	MK 4
A1301.9/16	1.9/16	39.69	1.5625	200.0	349.0	MK 4
A13040.0	–	40.00	1.5748	200.0	349.0	MK 4
A13040.5	–	40.50	1.5945	205.0	354.0	MK 4
A13041.0	–	41.00	1.6142	205.0	354.0	MK 4
A1301.5/8	1.5/8	41.28	1.6250	205.0	354.0	MK 4
A13041.5	–	41.50	1.6339	205.0	354.0	MK 4
A13042.0	–	42.00	1.6535	205.0	354.0	MK 4
A13042.5	–	42.50	1.6732	205.0	354.0	MK 4
A1301.11/16	1.11/16	42.86	1.6875	210.0	359.0	MK 4
A13043.0	–	43.00	1.6929	210.0	359.0	MK 4
A13043.5	–	43.50	1.7126	210.0	359.0	MK 4
A13044.0	–	44.00	1.7323	210.0	359.0	MK 4
A1301.3/4	1.3/4	44.45	1.7500	210.0	359.0	MK 4
A13044.5	–	44.50	1.7520	210.0	359.0	MK 4
A13045.0	–	45.00	1.7717	210.0	359.0	MK 4
A13045.5	–	45.50	1.7913	215.0	364.0	MK 4
A13046.0	–	46.00	1.8110	215.0	364.0	MK 4
A13046.5	–	46.50	1.8307	215.0	364.0	MK 4
A13047.0	–	47.00	1.8504	215.0	364.0	MK 4
A13047.5	–	47.50	1.8701	215.0	364.0	MK 4
A13048.0	–	48.00	1.8898	220.0	369.0	MK 4
A13048.5	–	48.50	1.9094	220.0	369.0	MK 4
A13049.0	–	49.00	1.9291	220.0	369.0	MK 4
A13049.5	–	49.50	1.9488	220.0	369.0	MK 4
A13050.0	–	50.00	1.9685	220.0	369.0	MK 4
A1302	2"	50.80	2.0000	225.0	374.0	MK 4

A350



HSS Long Series Taper Shank Drill, Steam Tempered Finish

Recommended for drilling deep holes or for applications where increased reach is required. Steam tempered finish retains cutting fluid and prevents chip to tool welding. A 118° point angle is easy to regrind and provides strength. Suitable for drilling many materials.

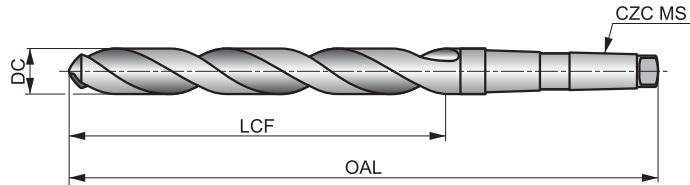

HSS	DIN 341	6xD
118°	ST	
λ 20-35°	R	DC h8

Workpiece material group suitability, starting values for cutting speed (m/min) and feed Alpha Code. Tables with feed per revolution can be found starting from page 71.

P1.1 ■ 27 I	P1.2 ■ 30 I	P1.3 ■ 31 I	P2.1 ■ 23 I	P2.2 ■ 20 G	P2.3 ■ 18 E	P3.1 ■ 15 F	P3.2 ■ 12 F	P3.3 ■ 10 E	P4.1 ■ 9 F	P4.2 ■ 7 E	P4.3 ■ 6 D	M1.1 ■ 18 E	M1.2 ■ 15 E
M2.1 ■ 16 E	M2.2 ■ 13 E	M3.1 ■ 5 G	M3.2 ■ 4 G	M3.3 ■ 4 G	M4.1 ■ 8 C	K1.1 ■ 26 I	K1.2 ■ 19 F	K1.3 ■ 14 F	K2.1 ■ 22 E	K2.2 ■ 18 E	K2.3 ■ 14 E	K3.1 ■ 20 E	K3.2 ■ 15 E
K3.3 ■ 12 E	K4.1 ■ 18 E	K4.2 ■ 14 E	K4.3 ■ 10 E	K4.4 ■ 9 E	K4.5 ■ 7 E	K5.1 ■ 21 E	K5.2 ■ 15 E	K5.3 ■ 12 E	N1.1 ■ 33 J	N1.2 ■ 25 J	N1.3 ■ 17 I	N2.1 ■ 42 H	N2.2 ■ 37 H
N2.3 ■ 27 H	N3.1 ■ 59 H	N3.2 ■ 35 I	N3.3 ■ 18 F	N4.1 ■ 35 L	N4.2 ■ 26 J	N4.3 ■ 12 H	S1.1 ■ 16 F	S1.2 ■ 9 D	S1.3 ■ 5 B	S2.1 ■ 5 E	S2.2 ■ 4 A	S3.1 ■ 4 E	S3.2 ■ 3 A
S4.1 ■ 3 E	S4.2 ■ 2 A												

Product	DC (mm)	DC (inch)	LCF (mm)	OAL (mm)	CZC MS
A3505.0	5.00	0.1969	74.0	155.0	MK 1
A3505.5	5.50	0.2165	80.0	161.0	MK 1
A3506.0	6.00	0.2362	80.0	161.0	MK 1
A3506.7	6.70	0.2638	86.0	167.0	MK 1
A3506.8	6.80	0.2677	93.0	174.0	MK 1
A3507.0	7.00	0.2756	93.0	174.0	MK 1
A3507.5	7.50	0.2953	93.0	174.0	MK 1
A3508.0	8.00	0.3150	100.0	181.0	MK 1
A3508.4	8.40	0.3307	100.0	181.0	MK 1
A3508.5	8.50	0.3346	100.0	181.0	MK 1
A3508.75	8.75	0.3445	107.0	188.0	MK 1
A3509.0	9.00	0.3543	107.0	188.0	MK 1
A3509.5	9.50	0.3740	107.0	188.0	MK 1
A3509.8	9.80	0.3858	116.0	197.0	MK 1
A35010.0	10.00	0.3937	116.0	197.0	MK 1
A35010.2	10.20	0.4016	116.0	197.0	MK 1
A35010.5	10.50	0.4134	116.0	197.0	MK 1
A35010.7	10.70	0.4213	125.0	206.0	MK 1
A35011.0	11.00	0.4331	125.0	206.0	MK 1
A35011.5	11.50	0.4528	125.0	206.0	MK 1
A35011.75	11.75	0.4626	125.0	206.0	MK 1
A35011.8	11.80	0.4646	125.0	206.0	MK 1
A35012.0	12.00	0.4724	134.0	215.0	MK 1
A35012.5	12.50	0.4921	134.0	215.0	MK 1

Product	DC (mm)	DC (inch)	LCF (mm)	OAL (mm)	CZC MS
A35013.0	13.00	0.5118	134.0	215.0	MK 1
A35013.5	13.50	0.5315	142.0	223.0	MK 1
A35014.0	14.00	0.5512	142.0	223.0	MK 1
A35014.25	14.25	0.5610	147.0	245.0	MK 2
A35014.5	14.50	0.5709	147.0	245.0	MK 2
A35014.75	14.75	0.5807	147.0	245.0	MK 2
A35015.0	15.00	0.5906	147.0	245.0	MK 2
A35015.25	15.25	0.6004	153.0	251.0	MK 2
A35015.5	15.50	0.6102	153.0	251.0	MK 2
A35015.75	15.75	0.6201	153.0	251.0	MK 2
A35016.0	16.00	0.6299	153.0	251.0	MK 2
A35016.25	16.25	0.6398	159.0	257.0	MK 2
A35016.5	16.50	0.6496	159.0	257.0	MK 2
A35016.75	16.75	0.6594	159.0	257.0	MK 2
A35017.0	17.00	0.6693	159.0	257.0	MK 2
A35017.25	17.25	0.6791	165.0	263.0	MK 2
A35017.5	17.50	0.6890	165.0	263.0	MK 2
A35018.0	18.00	0.7087	165.0	263.0	MK 2
A35018.5	18.50	0.7283	171.0	269.0	MK 2
A35019.0	19.00	0.7480	171.0	269.0	MK 2
A35019.5	19.50	0.7677	177.0	275.0	MK 2
A35019.75	19.75	0.7776	177.0	275.0	MK 2
A35020.0	20.00	0.7874	177.0	275.0	MK 2
A35020.25	20.25	0.7972	184.0	282.0	MK 2



Product	DC	DC	LCF	OAL	CZC MS
	(mm)	(inch)	(mm)	(mm)	
A35020.5	20.50	0.8071	184.0	282.0	MK 2
A35021.0	21.00	0.8268	184.0	282.0	MK 2
A35021.5	21.50	0.8465	191.0	289.0	MK 2
A35022.0	22.00	0.8661	191.0	289.0	MK 2
A35022.5	22.50	0.8858	198.0	296.0	MK 2
A35023.0	23.00	0.9055	198.0	296.0	MK 2
A35023.5	23.50	0.9252	198.0	319.0	MK 3
A35024.0	24.00	0.9449	206.0	327.0	MK 3
A35024.5	24.50	0.9646	206.0	327.0	MK 3
A35025.0	25.00	0.9843	206.0	327.0	MK 3
A35025.5	25.50	1.0039	214.0	335.0	MK 3
A35026.0	26.00	1.0236	214.0	335.0	MK 3
A35026.5	26.50	1.0433	214.0	335.0	MK 3
A35027.0	27.00	1.0630	222.0	343.0	MK 3
A35027.5	27.50	1.0827	222.0	343.0	MK 3
A35028.0	28.00	1.1024	222.0	343.0	MK 3
A35029.0	29.00	1.1417	230.0	351.0	MK 3
A35030.0	30.00	1.1811	230.0	351.0	MK 3
A35030.5	30.50	1.2008	239.0	360.0	MK 3
A35031.0	31.00	1.2205	239.0	360.0	MK 3

Product	DC	DC	LCF	OAL	CZC MS
	(mm)	(inch)	(mm)	(mm)	
A35031.5	31.50	1.2402	239.0	360.0	MK 3
A35032.0	32.00	1.2598	248.0	397.0	MK 4
A35033.0	33.00	1.2992	248.0	397.0	MK 4
A35034.0	34.00	1.3386	257.0	406.0	MK 4
A35035.0	35.00	1.3780	257.0	406.0	MK 4
A35036.0	36.00	1.4173	267.0	416.0	MK 4
A35037.0	37.00	1.4567	267.0	416.0	MK 4
A35038.0	38.00	1.4961	277.0	426.0	MK 4
A35039.0	39.00	1.5354	277.0	426.0	MK 4
A35040.0	40.00	1.5748	277.0	426.0	MK 4
A35041.0	41.00	1.6142	287.0	436.0	MK 4
A35042.0	42.00	1.6535	287.0	436.0	MK 4
A35043.0	43.00	1.6929	298.0	447.0	MK 4
A35044.0	44.00	1.7323	298.0	447.0	MK 4
A35045.0	45.00	1.7717	298.0	447.0	MK 4
A35046.0	46.00	1.8110	310.0	459.0	MK 4
A35047.0	47.00	1.8504	310.0	459.0	MK 4
A35048.0	48.00	1.8898	321.0	470.0	MK 4
A35050.0	50.00	1.9685	321.0	470.0	MK 4

A345



HSS Long Series Taper Shank Drill (DIN 1870 Series 1), Steam Tempered Finish

Recommended for drilling very deep holes or for applications where increased reach is required. A 118° point angle is easy to regrind and provides strength. Steam tempered finish retains cutting fluid and prevents chip to tool welding. Suitable for drilling many materials.

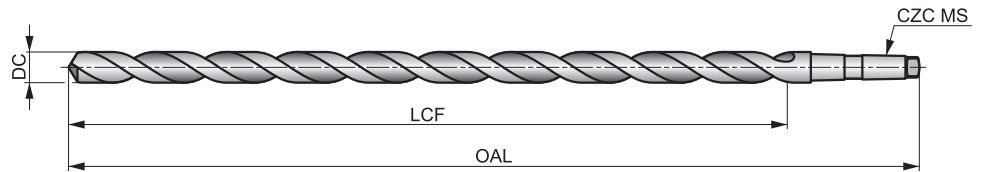

HSS	DIN 1870(1)	10×D
118°	ST	
λ 20-35°	R	DC h8

Workpiece material group suitability, starting values for cutting speed (m/min) and feed Alpha Code. Tables with feed per revolution can be found starting from page 71.

P1.1 ■ 23 G	P1.2 ■ 25 G	P1.3 ■ 26 G	P2.1 ■ 19 G	P2.2 ■ 17 E	P2.3 ■ 15 C	P3.1 ■ 9 D	P3.2 ■ 7 D	P3.3 ■ 6 C	P4.1 ■ 5 D	P4.2 ■ 4 C	P4.3 ■ 4 B	M1.1 ■ 16 C	M1.2 ■ 14 C
M2.1 ■ 15 C	M2.2 ■ 12 C	M3.1 ■ 5 E	M3.2 ■ 4 E	M3.3 ■ 4 E	M4.1 ■ 8 A	K1.1 ■ 22 G	K1.2 ■ 16 D	K1.3 ■ 12 D	K2.1 ■ 16 C	K2.2 ■ 13 C	K2.3 ■ 10 C	K3.1 ■ 14 C	K3.2 ■ 11 C
K3.3 ■ 9 C	K4.1 ■ 13 C	K4.2 ■ 10 C	K4.3 ■ 7 C	K4.4 ■ 6 C	K4.5 ■ 5 C	K5.1 ■ 15 C	K5.2 ■ 11 C	K5.3 ■ 9 C	N1.1 ■ 33 H	N1.2 ■ 25 H	N1.3 ■ 17 G	N2.1 ■ 42 F	N2.2 ■ 37 F
N2.3 ■ 27 F	N3.1 ■ 56 F	N3.2 ■ 33 G	N3.3 ■ 17 D	N4.1 ■ 30 J	N4.2 ■ 30 H	N4.3 ■ 10 F	S1.1 ■ 15 D	S1.2 ■ 9 B	S1.3 ■ 5 A	S2.1 ■ 5 C	S2.2 ■ 4 A	S3.1 ■ 4 C	S3.2 ■ 3 A
S4.1 ■ 3 C	S4.2 ■ 2 A												

DC > 25.4mm less than 10xD.

Product	DC (inch)	DC (mm)	DC (inch)	LCF (mm)	OAL (mm)	CZC MS
A3458.0	–	8.00	0.3150	165.0	265.0	MK 1
A3458.5	–	8.50	0.3346	165.0	265.0	MK 1
A3459.0	–	9.00	0.3543	175.0	275.0	MK 1
A3459.5	–	9.50	0.3740	175.0	275.0	MK 1
A3453/8	3/8	9.52	0.3750	185.0	285.0	MK 1
A34510.0	–	10.00	0.3937	185.0	285.0	MK 1
A34513/32	13/32	10.32	0.4063	185.0	285.0	MK 1
A34510.5	–	10.50	0.4134	185.0	285.0	MK 1
A34511.0	–	11.00	0.4331	195.0	300.0	MK 1
A3457/16	7/16	11.11	0.4375	195.0	300.0	MK 1
A34511.5	–	11.50	0.4528	195.0	300.0	MK 1
A34529/64	29/64	11.51	0.4531	205.0	310.0	MK 1
A34512.0	–	12.00	0.4724	205.0	310.0	MK 1
A34512.5	–	12.50	0.4921	205.0	310.0	MK 1
A3451/2	1/2	12.70	0.5000	205.0	310.0	MK 1
A34513.0	–	13.00	0.5118	205.0	310.0	MK 1
A34517/32	17/32	13.49	0.5313	220.0	325.0	MK 1
A34513.5	–	13.50	0.5315	220.0	325.0	MK 1
A34514.0	–	14.00	0.5512	220.0	325.0	MK 1
A3459/16	9/16	14.29	0.5625	220.0	340.0	MK 2
A34537/64	37/64	14.68	0.5781	220.0	340.0	MK 2
A34515.0	–	15.00	0.5906	220.0	340.0	MK 2
A34539/64	39/64	15.48	0.6094	230.0	355.0	MK 2

Product	DC (inch)	DC (mm)	DC (inch)	LCF (mm)	OAL (mm)	CZC MS
A34515.5	–	15.50	0.6102	230.0	355.0	MK 2
A3455/8	5/8	15.88	0.6250	230.0	355.0	MK 2
A34516.0	–	16.00	0.6299	230.0	355.0	MK 2
A34541/64	41/64	16.27	0.6406	230.0	355.0	MK 2
A34516.5	–	16.50	0.6496	230.0	355.0	MK 2
A34521/32	21/32	16.67	0.6563	230.0	355.0	MK 2
A34517.0	–	17.00	0.6693	230.0	355.0	MK 2
A34511/16	11/16	17.46	0.6875	245.0	370.0	MK 2
A34517.5	–	17.50	0.6890	245.0	370.0	MK 2
A34518.0	–	18.00	0.7087	245.0	370.0	MK 2
A34518.5	–	18.50	0.7283	245.0	370.0	MK 2
A34519.0	–	19.00	0.7480	245.0	370.0	MK 2
A3453/4	3/4	19.05	0.7500	260.0	385.0	MK 2
A34519.5	–	19.50	0.7677	260.0	385.0	MK 2
A34520.0	–	20.00	0.7874	260.0	385.0	MK 2
A34520.5	–	20.50	0.8071	260.0	385.0	MK 2
A34521.0	–	21.00	0.8268	260.0	385.0	MK 2
A34521.5	–	21.50	0.8465	270.0	405.0	MK 2
A34522.0	–	22.00	0.8661	270.0	405.0	MK 2
A3457/8	7/8	22.22	0.8750	270.0	405.0	MK 2
A34522.5	–	22.50	0.8858	270.0	405.0	MK 3
A34523.0	–	23.00	0.9055	270.0	405.0	MK 3
A34523.5	–	23.50	0.9252	270.0	425.0	MK 3



Product	DC	DC	DC	LCF	OAL	CZC MS
	(inch)	(mm)	(inch)	(mm)	(mm)	
A34524.0	–	24.00	0.9449	290.0	440.0	MK 3
A34524.5	–	24.50	0.9646	290.0	440.0	MK 3
A34525.0	–	25.00	0.9843	290.0	440.0	MK 3
A3451	1"	25.40	1.0000	290.0	440.0	MK 3
A34525.5	–	25.50	1.0039	290.0	440.0	MK 3
A34526.0	–	26.00	1.0236	290.0	440.0	MK 3
A34526.5	–	26.50	1.0433	290.0	440.0	MK 3
A34527.0	–	27.00	1.0630	305.0	460.0	MK 3
A34528.0	–	28.00	1.1024	305.0	460.0	MK 3
A34529.0	–	29.00	1.1417	305.0	460.0	MK 3
A34530.0	–	30.00	1.1811	305.0	460.0	MK 3
A3451.1/4	1.1/4	31.75	1.2500	320.0	480.0	MK 3

Product	DC	DC	DC	LCF	OAL	CZC MS
	(inch)	(mm)	(inch)	(mm)	(mm)	
A34531.0	–	31.00	1.2205	320.0	480.0	MK 3
A34532.0	–	32.00	1.2598	320.0	505.0	MK 4
A34533.0	–	33.00	1.2992	320.0	505.0	MK 4
A34534.0	–	34.00	1.3386	340.0	530.0	MK 4
A34535.0	–	35.00	1.3780	340.0	530.0	MK 4
A34536.0	–	36.00	1.4173	340.0	530.0	MK 4
A34537.0	–	37.00	1.4567	340.0	530.0	MK 4
A34538.0	–	38.00	1.4961	360.0	555.0	MK 4
A3451.1/2	1.1/2	38.10	1.5000	360.0	555.0	MK 4
A34539.0	–	39.00	1.5354	360.0	555.0	MK 4
A34540.0	–	40.00	1.5748	360.0	555.0	MK 4

A530

HSS Taper Shank Drill, TiN Coated

A strong 118° conventional point which is easy to regrind and the robust design provides increased performance when used on conventional machines. Suitable for drilling many materials. TiN coating improves performance and extends the tool life.

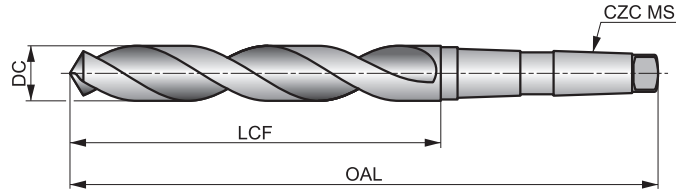

HSS	DIN 345	4xD
118°	TiN	
λ 20-35°	R	DC h8

Workpiece material group suitability, starting values for cutting speed (m/min) and feed Alpha Code. Tables with feed per revolution can be found starting from page 71.

P1.1 ■ 40 I	P1.2 ■ 45 I	P1.3 ■ 46 I	P2.1 ■ 34 I	P2.2 ■ 30 F	P2.3 ■ 27 E	P3.1 ■ 29 F	P3.2 ■ 24 F	P3.3 ■ 20 E	P4.1 ■ 18 F	P4.2 ■ 15 E	P4.3 ■ 12 D	M1.1 ■ 33 E	M1.2 ■ 28 E
M2.1 ■ 29 E	M2.2 ■ 24 E	M3.1 ■ 15 G	M3.2 ■ 13 G	M3.3 ■ 12 G	M4.1 ■ 20 C	K1.1 ■ 36 I	K1.2 ■ 27 E	K1.3 ■ 20 E	K2.1 ■ 33 E	K2.2 ■ 27 E	K2.3 ■ 22 E	K3.1 ■ 29 E	K3.2 ■ 22 E
K3.3 ■ 18 E	K4.1 ■ 27 E	K4.2 ■ 21 E	K4.3 ■ 15 E	K4.4 ■ 13 E	K4.5 ■ 11 E	K5.1 ■ 31 E	K5.2 ■ 23 E	K5.3 ■ 18 E	N1.1 ■ 55 I	N1.2 ■ 41 I	N1.3 ■ 28 I	N2.1 ■ 54 G	N2.2 ■ 48 G
N2.3 ■ 35 G	N3.1 ■ 93 G	N3.2 ■ 55 I	N3.3 ■ 28 G	N4.1 ■ 50 J	N4.2 ■ 50 H	N4.3 ■ 35 F	S1.1 ■ 32 F	S1.2 ■ 18 D	S1.3 ■ 13 B	S2.1 ■ 8 E	S2.2 ■ 4 A	S3.1 ■ 6 E	S3.2 ■ 3 A
S4.1 ■ 5 E	S4.2 ■ 2 A												

DC >= 14mm Point Thinned.

Product	DC	DC	LCF	OAL	CZC MS
	(mm)	(inch)			
A5308.5	8.50	0.3346	75.0	156.0	MK 1
A5309.0	9.00	0.3543	81.0	162.0	MK 1
A53010.0	10.00	0.3937	87.0	168.0	MK 1
A53010.2	10.20	0.4016	87.0	168.0	MK 1
A53010.5	10.50	0.4134	87.0	168.0	MK 1
A53011.0	11.00	0.4331	94.0	175.0	MK 1
A53011.5	11.50	0.4528	94.0	175.0	MK 1
A53011.75	11.75	0.4626	94.0	175.0	MK 1
A53012.0	12.00	0.4724	101.0	182.0	MK 1
A53012.5	12.50	0.4921	101.0	182.0	MK 1
A53013.0	13.00	0.5118	101.0	182.0	MK 1
A53013.5	13.50	0.5315	108.0	189.0	MK 1
A53014.0	14.00	0.5512	108.0	189.0	MK 1
A53014.5	14.50	0.5709	114.0	212.0	MK 2
A53015.0	15.00	0.5906	114.0	212.0	MK 2
A53015.25	15.25	0.6004	120.0	218.0	MK 2
A53015.5	15.50	0.6102	120.0	218.0	MK 2
A53016.0	16.00	0.6299	120.0	218.0	MK 2
A53016.5	16.50	0.6496	125.0	223.0	MK 2
A53017.0	17.00	0.6693	125.0	223.0	MK 2
A53017.5	17.50	0.6890	130.0	228.0	MK 2
A53018.0	18.00	0.7087	130.0	228.0	MK 2
A53018.5	18.50	0.7283	135.0	233.0	MK 2
A53019.0	19.00	0.7480	135.0	233.0	MK 2
A53019.5	19.50	0.7677	140.0	238.0	MK 2
A53020.0	20.00	0.7874	140.0	238.0	MK 2

Product	DC	DC	LCF	OAL	CZC MS
	(mm)	(inch)			
A53020.5	20.50	0.8071	145.0	243.0	MK 2
A53021.0	21.00	0.8268	145.0	243.0	MK 2
A53021.5	21.50	0.8465	150.0	248.0	MK 2
A53022.0	22.00	0.8661	150.0	248.0	MK 2
A53022.5	22.50	0.8858	155.0	253.0	MK 2
A53023.0	23.00	0.9055	155.0	253.0	MK 2
A53023.5	23.50	0.9252	155.0	276.0	MK 3
A53024.0	24.00	0.9449	160.0	281.0	MK 3
A53024.5	24.50	0.9646	160.0	281.0	MK 3
A53025.0	25.00	0.9843	160.0	281.0	MK 3
A53025.5	25.50	1.0039	165.0	286.0	MK 3
A53026.0	26.00	1.0236	165.0	286.0	MK 3
A53026.5	26.50	1.0433	165.0	286.0	MK 3
A53027.0	27.00	1.0630	170.0	291.0	MK 3
A53027.5	27.50	1.0827	170.0	291.0	MK 3
A53028.0	28.00	1.1024	170.0	291.0	MK 3
A53028.5	28.50	1.1220	175.0	296.0	MK 3
A53029.0	29.00	1.1417	175.0	296.0	MK 3
A53029.5	29.50	1.1614	175.0	296.0	MK 3
A53030.0	30.00	1.1811	175.0	296.0	MK 3
A53031.0	31.00	1.2205	180.0	301.0	MK 3
A53032.0	32.00	1.2598	185.0	334.0	MK 4
A53033.0	33.00	1.2992	185.0	334.0	MK 4
A53035.0	35.00	1.3780	190.0	339.0	MK 4
A53040.0	40.00	1.5748	200.0	349.0	MK 4

A730

HSS-E (8% Cobalt) Taper Shank Drill, Bronze Tempered Finish

Recommended for difficult materials and applications. The 118° point provides a strong point which is easy to regrind. Suitable for drilling many materials. The bronze finish is a thin oxide layer and it is an indication for Cobalt.

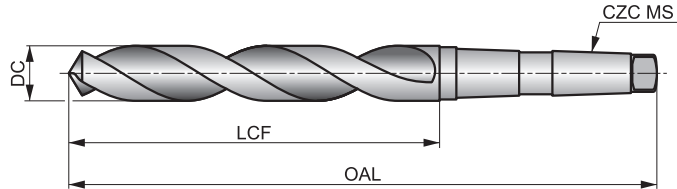

HSS-E	DIN 345	4xD
118°	Bronze	
λ 20-35°	R	DC h8

Workpiece material group suitability, starting values for cutting speed (m/min) and feed Alpha Code. Tables with feed per revolution can be found starting from page 71.

P1.1 36 H	P1.2 40 H	P1.3 41 H	P2.1 31 H	P2.2 27 G	P2.3 24 E	P3.1 25 F	P3.2 20 F	P3.3 17 E	P4.1 15 F	P4.2 13 E	P4.3 10 D	M1.1 33 E	M1.2 28 E
M2.1 29 E	M2.2 24 E	M3.1 13 G	M3.2 11 G	M3.3 10 G	M4.1 17 C	K1.1 35 J	K1.2 26 G	K1.3 19 G	K2.1 27 E	K2.2 22 E	K2.3 18 E	K3.1 24 E	K3.2 18 E
K3.3 15 E	K4.1 22 E	K4.2 17 E	K4.3 12 E	K4.4 11 E	K4.5 9 E	K5.1 25 E	K5.2 19 E	K5.3 15 E	N1.1 33 J	N1.2 25 J	N1.3 17 I	N2.1 46 H	N2.2 42 H
N2.3 30 H	N3.1 68 H	N3.2 40 J	N3.3 20 L	N4.1 35 K	N4.2 28 J	N4.3 20 H	S1.1 28 G	S1.2 20 D	S1.3 11 C	S2.1 9 E	S2.2 8 B	S3.1 7 E	S3.2 6 B
S4.1 5 E	S4.2 5 B												

DC >= 14mm Point Thinned.

Product	DC (mm)	DC (inch)	LCF (mm)	OAL (mm)	CZC MS	Product	DC (mm)	DC (inch)	LCF (mm)	OAL (mm)	CZC MS
A73010.0	10.00	0.3937	87.0	168.0	MK 1	A73016.25	16.25	0.6398	120.0	218.0	MK 2
A73010.2	10.20	0.4016	87.0	168.0	MK 1	A73016.5	16.50	0.6496	125.0	223.0	MK 2
A73010.5	10.50	0.4134	87.0	168.0	MK 1	A73017.0	17.00	0.6693	125.0	223.0	MK 2
A73010.8	10.80	0.4252	94.0	175.0	MK 1	A73017.25	17.25	0.6791	130.0	228.0	MK 2
A73011.0	11.00	0.4331	94.0	175.0	MK 1	A73017.5	17.50	0.6890	130.0	228.0	MK 2
A73011.5	11.50	0.4528	94.0	175.0	MK 1	A73017.75	17.75	0.6988	130.0	228.0	MK 2
A73011.8	11.80	0.4646	94.0	175.0	MK 1	A73018.0	18.00	0.7087	130.0	228.0	MK 2
A73012.0	12.00	0.4724	101.0	182.0	MK 1	A73018.25	18.25	0.7185	135.0	233.0	MK 2
A73012.2	12.20	0.4803	101.0	182.0	MK 1	A73018.5	18.50	0.7283	135.0	233.0	MK 2
A73012.5	12.50	0.4921	101.0	182.0	MK 1	A73018.75	18.75	0.7382	135.0	233.0	MK 2
A73012.8	12.80	0.5039	101.0	182.0	MK 1	A73019.0	19.00	0.7480	135.0	233.0	MK 2
A73013.0	13.00	0.5118	101.0	182.0	MK 1	A73019.25	19.25	0.7579	140.0	238.0	MK 2
A73013.5	13.50	0.5315	108.0	189.0	MK 1	A73019.5	19.50	0.7677	140.0	238.0	MK 2
A73013.8	13.80	0.5433	108.0	189.0	MK 1	A73019.75	19.75	0.7776	140.0	238.0	MK 2
A73014.0	14.00	0.5512	108.0	189.0	MK 1	A73020.0	20.00	0.7874	140.0	238.0	MK 2
A73014.25	14.25	0.5610	114.0	212.0	MK 2	A73020.25	20.25	0.7972	145.0	243.0	MK 2
A73014.5	14.50	0.5709	114.0	212.0	MK 2	A73020.5	20.50	0.8071	145.0	243.0	MK 2
A73014.75	14.75	0.5807	114.0	212.0	MK 2	A73020.75	20.75	0.8169	145.0	243.0	MK 2
A73015.0	15.00	0.5906	114.0	212.0	MK 2	A73021.0	21.00	0.8268	145.0	243.0	MK 2
A73015.25	15.25	0.6004	120.0	218.0	MK 2	A73021.5	21.50	0.8465	150.0	248.0	MK 2
A73015.5	15.50	0.6102	120.0	218.0	MK 2	A73022.0	22.00	0.8661	150.0	248.0	MK 2
A73015.75	15.75	0.6201	120.0	218.0	MK 2	A73022.5	22.50	0.8858	155.0	253.0	MK 2
A73016.0	16.00	0.6299	120.0	218.0	MK 2	A73023.0	23.00	0.9055	155.0	253.0	MK 2



Product	DC	DC	LCF	OAL	CZC MS
	(mm)	(inch)	(mm)	(mm)	
A73023.5	23.50	0.9252	155.0	276.0	MK 3
A73024.0	24.00	0.9449	160.0	281.0	MK 3
A73024.5	24.50	0.9646	160.0	281.0	MK 3
A73025.0	25.00	0.9843	160.0	281.0	MK 3
A73025.5	25.50	1.0039	165.0	286.0	MK 3
A73026.0	26.00	1.0236	165.0	286.0	MK 3
A73026.5	26.50	1.0433	165.0	286.0	MK 3
A73027.0	27.00	1.0630	170.0	291.0	MK 3

Product	DC	DC	LCF	OAL	CZC MS
	(mm)	(inch)	(mm)	(mm)	
A73027.5	27.50	1.0827	170.0	291.0	MK 3
A73028.0	28.00	1.1024	170.0	291.0	MK 3
A73028.5	28.50	1.1220	175.0	296.0	MK 3
A73029.0	29.00	1.1417	175.0	296.0	MK 3
A73030.0	30.00	1.1811	175.0	296.0	MK 3
A73031.0	31.00	1.2205	180.0	301.0	MK 3
A73032.0	32.00	1.2598	185.0	334.0	MK 4

A166



HSS Taper Shank Drill, Steam Tempered Finish, with Brazed Carbide Point

Brazed carbide tip gives the high performance of a carbide drill with a strong and less brittle HSS body. It has a 118°, four-facet point which helps with self-centering and is easy to regrind, making it an economical choice when drilling cast iron materials.

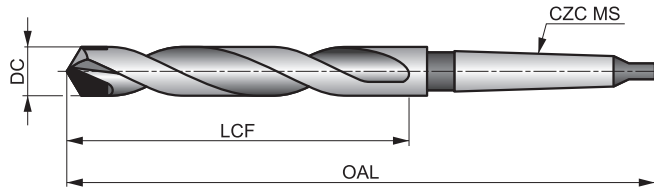

HSS HM	DIN 345	4×D
118°	Bright ST	
λ 20-35°	R	DC h8

Workpiece material group suitability, starting values for cutting speed (m/min) and feed Alpha Code. Tables with feed per revolution can be found starting from page 71.

P1.1 ▣ 73 E	P1.2 ▣ 82 E	P1.3 ▣ 85 E	P2.1 ▣ 63 E	P2.2 ▣ 55 D	P2.3 ▣ 49 C	P3.1 ▣ 59 D	P3.2 ▣ 47 D	P3.3 ▣ 40 C	P4.1 ▣ 35 D	P4.2 ▣ 30 C	P4.3 ▣ 24 A	M1.1 ▣ 55 B	M1.2 ▣ 46 B
M2.1 ▣ 49 B	M2.2 ▣ 40 B	M3.1 ▣ 41 C	M3.2 ▣ 35 C	M3.3 ▣ 32 C	M4.1 ▣ 35 A	K1.1 ▣ 50 C	K1.2 ▣ 37 C	K1.3 ▣ 28 C	K2.1 ▣ 43 C	K2.2 ▣ 35 C	K2.3 ▣ 28 A	K3.1 ▣ 38 C	K3.2 ▣ 29 C
K3.3 ▣ 24 A	K4.1 ▣ 35 C	K4.2 ▣ 27 C	K4.3 ▣ 20 A	K4.4 ▣ 17 A	K4.5 ▣ 14 A	K5.1 ▣ 40 C	K5.2 ▣ 30 C	K5.3 ▣ 23 A	N1.1 ▣ 50 I	N1.2 ▣ 38 I	N1.3 ▣ 25 H	N2.1 ▣ 62 G	N2.2 ▣ 55 G
N2.3 ▣ 40 G	N3.1 ▣ 127 C	N3.2 ▣ 75 G	N3.3 ▣ 38 D	N4.2 ▣ 60 E	S1.1 ▣ 35 A	S1.2 ▣ 35 A	S1.3 ▣ 25 A	S2.1 ▣ 33 A	S2.2 ▣ 28 A	S3.1 ▣ 25 A	S3.2 ▣ 20 A	S4.1 ▣ 20 A	S4.2 ▣ 16 A

Product	DC	DC	LCF	OAL	CZC MS	Product	DC	DC	LCF	OAL	CZC MS
	(mm)	(inch)					(mm)	(mm)			
A16610.0	10.00	0.3937	87.0	168.0	MK 1	A16620.0	20.00	0.7874	140.0	238.0	MK 2
A16610.5	10.50	0.4134	87.0	168.0	MK 1	A16621.0	21.00	0.8268	145.0	243.0	MK 2
A16611.0	11.00	0.4331	94.0	175.0	MK 1	A16622.0	22.00	0.8661	150.0	248.0	MK 2
A16611.5	11.50	0.4528	94.0	175.0	MK 1	A16622.5	22.50	0.8858	155.0	253.0	MK 2
A16612.0	12.00	0.4724	101.0	182.0	MK 1	A16623.0	23.00	0.9055	155.0	253.0	MK 2
A16613.0	13.00	0.5118	101.0	182.0	MK 1	A16624.0	24.00	0.9449	160.0	281.0	MK 3
A16613.5	13.50	0.5315	108.0	189.0	MK 1	A16625.0	25.00	0.9843	160.0	281.0	MK 3
A16614.0	14.00	0.5512	108.0	189.0	MK 1	A16626.0	26.00	1.0236	165.0	286.0	MK 3
A16615.0	15.00	0.5906	114.0	212.0	MK 2	A16627.0	27.00	1.0630	170.0	291.0	MK 3
A16616.0	16.00	0.6299	120.0	218.0	MK 2	A16628.0	28.00	1.1024	170.0	291.0	MK 3
A16617.0	17.00	0.6693	125.0	223.0	MK 2	A16629.0	29.00	1.1417	175.0	296.0	MK 3
A16617.5	17.50	0.6890	130.0	228.0	MK 2	A16630.0	30.00	1.1811	175.0	296.0	MK 3
A16618.0	18.00	0.7087	130.0	228.0	MK 2	A16632.0	32.00	1.2598	185.0	334.0	MK 4
A16619.0	19.00	0.7480	135.0	233.0	MK 2	A16633.0	33.00	1.2992	185.0	334.0	MK 4

M150



Morse Tapered Sleeve, Oil Toughened

Adaptor used to enable drills with smaller taper shanks to be held in machine spindles with larger morse tapers.

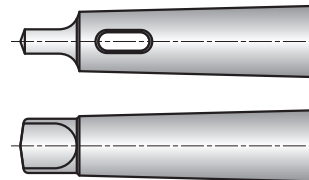

K= External Morse Cone; K1=Internal Morse Cone.

Product	Nr.	K = Nr.	K1 = Nr.
M1501-0	10	Nr. 1	Nr. 0
M1502-1	21	Nr. 2	Nr. 1
M1503-1	31	Nr. 3	Nr. 1
M1504-1	41	Nr. 4	Nr. 1
M1503-2	32	Nr. 3	Nr. 2
M1504-2	42	Nr. 4	Nr. 2
M1505-2	52	Nr. 5	Nr. 2
M1504-3	43	Nr. 4	Nr. 3
M1505-3	53	Nr. 5	Nr. 3
M1505-4	54	Nr. 5	Nr. 4
M1506-5	65	Nr. 6	Nr. 5

M152



Drill Drift

Used to eject taper shank drills from machine spindles and morse taper sleeves.



Product	Nr.
M1520	Nr. 0
M15212	Nr. 1 + 2
M15234	Nr. 3 + 4
M15245	Nr 4 + 5
M1526	Nr 6



A088



HSS Stub Drill Set with A022 Drills, TiN-Tip Coated

A set containing 24 different diameters of the A022 stub drill in a sturdy case, for a wide range of hole sizes covered with a single purchase. The drills are suitable for use both in machines and hand-held drilling in many applications. TiN-Tip coating improves performance and extends tool life.

HSS	DIN ANSI	2.5xD
135°	TiN-Tip	
λ 20-35°	R	DC h8

A=Styles in Set, B=No. in Set, C=Diameters in Set.

Product	Nr.	A	B	C
A088200S	200S	A022	24	1.0 mm - 10.5 mm x 0.5 mm + 3.3 mm, 4.2 mm, 6.8 mm, 10.2 mm

A095

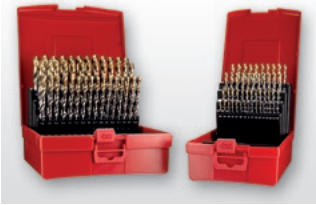

HSS Jobber Drill Set with A002 Drills, TiN-Tip Coated

Different sets in metric or fractional sizes of our A002 drills in a useful plastic storage case. The set keeps all drills together, with sizes clearly displayed for easy selection. The drills are suitable for use in both machines and hand-held applications. TiN-Tip coating improves performance and extends tool life.

HSS	DIN 338	4xD
118°	TiN-Tip	
20-35°	R	DC h8

1.0mm =< DC >= 2.9mm 118° 4 Facet Point. A=Styles in Set, B=No. in Set, C=Diameters in Set.

Product	Nr.	A	B	C
A09518	18	A002	29	1/16 inch - 1/2 inch x 1/64 inch
A09520	20	A002	15	1/16 inch - 1/2 inch x 1/32 inch
A095200	200	A002	24	1.0 mm - 10.5 mm x 0.5 mm + 3.3 mm, 4.2 mm, 6.8 mm, 10.2 mm
A095201	201	A002	19	1.0 mm - 10.0 mm x 0.5 mm
A095202	202	A002	51	1.0 mm - 6.0 mm x 0.1 mm
A095203	203	A002	41	6.0 mm - 10.0 mm x 0.1 mm
A095204	204	A002	25	1.0 mm - 13.0 mm x 0.5 mm
A095206	206	A002	29	1.0 mm - 13.0 mm x 0.5 mm + 3.3 mm, 4.2 mm, 6.8 mm, 10.2 mm
A095209	209	A002	91	1.0 mm - 10.0 mm x 0.1 mm

A087



HSS Jobber Drill Set with A002 Drills, TiN-Tip Coated

A set containing 19 different diameters of the popular A002 drill in an easy to carry compact case, with sizes clearly displayed for easy selection. The drills are suitable for use both in machines and hand-held drilling, and in many applications. TiN-Tip coating improves performance and extends tool life.

A=Styles in Set, B=No. in Set, C=Diameters in Set. 1.0mm =< DC >= 2.9mm 118° 4 Facet Point.

Product	Nr.	A	B	C
A087201	201	A002	19	1.0 mm - 10.0 mm x 0.5 mm

A094



HSS Jobber Drill Set with A002 Drills, TiN-Tip Coated

A set containing A002 drills of different metric diameters in a cleverly designed rotating dispenser which makes selecting the required size very simple. Rotate the clear plastic top, until the required size is highlighted by the hole in the case, and turn the set upside down to remove the drill.

HSS	DIN 338	4xD
118°	TiN-Tip	
λ 20-35°	R	DC h8

A=Styles in Set, B=No. in Set, C=Diameters in Set. 1.0mm =< DC >= 2.9mm 118° 4 Facet Point.

Product	Nr.	A	B	C
A094413	413	A002	13	1.5 mm - 6.5 mm x 0.5 mm + 3.3 mm, 4.2 mm
A094419	419	A002	19	1.0 mm - 10.0 mm x 0.5 mm

A089



HSS Jobber Drill Set with A002 Drills, TiN-Tip Coated

A set containing 5 different diameters of the popular A002 drill in a handy container, covering many diameters with a single purchase. The drills are suitable for use both in machines and hand-held drilling in many applications. TiN-Tip coating improves performance and extends tool life.

A=Styles in Set, B=No. in Set, C=Diameters in Set.

Product	Nr.	A	B	C
A08910	10	A002	5	A0024.0, A0025.0, A0026.0, A0028.0, A00210.0

A190



HSS Jobber Drill Set with A100 Drills, Steam Tempered Finish

Drill set containing A100 jobber drills with conventional 118° point. Provided in metric or fractional size sets in a handy plastic case which makes selecting the required drill size very simple.

HSS	DIN 338	4xD
118°	ST	
λ 20-35°		DC h8

A=Styles in Set, B=No. in Set, C=Diameters in Set. DC <= 1mm; 3/64"; N60 Bright.

Product	Nr.	A	B	C
A1903	3	A100	21	1/16 inch - 3/8 inch x 1/64 inch
A19012	12	A100	60	No.1 - No.60
A19018	18	A100	29	1/16 inch - 1/2 inch x 1/64 inch
A19020	20	A100	15	1/16 inch - 1/2 inch x 1/32 inch
A190201	201	A100	19	1.0 mm - 10.0 mm x 0.5 mm
A190202	202	A100	51	1.0 mm - 6.0 mm x 0.1 mm
A190203	203	A100	41	6.0 mm - 10.0 mm x 0.1 mm
A190204	204	A100	25	1.0 mm - 13.0 mm x 0.5 mm
A190206	206	A100	29	1.0 mm - 13.0 mm x 0.5 mm + 3.3 mm, 4.2 mm, 6.8 mm, 10.2 mm
A190209¹⁾	209	A100	91	1.0 mm - 10.0 mm x 0.1 mm

¹⁾ Sold in 2 boxes: box 1 contains sizes (1.0-5.9 x 0.1mm); box 2 contains sizes (6.0-10.0 x 0.1mm).

A191



HSS Jobber Drill Set with A100 Drills, Steam Tempered Finish

A set containing A100 drills of different metric diameters in an easy to carry compact case with sizes clearly displayed and easy drill selection. A100 jobber drills with Conventional 118° point. Provided in metric or wire size sets in a handy plastic case which makes selecting the required drill size very simple.

HSS	DIN 338	4xD
118°	ST	
λ 20-35°	R	DC h8

A=Styles in Set, B=No. in Set, C=Diameters in Set. DC <= 1mm; 3/64"; N60 Bright.

Product	Nr.	A	B	C
A19131M	31M	A100	20	0.3 mm - 1.0 mm x 0.05 mm + 0.38 mm, 0.52 mm, 0.58 mm, 0.78 mm, 0.82 mm
A19161-80	61-80	A100	20	No.61 - No. 80

A191



HSS Jobber Drill Set with A100 Drills, Steam Tempered Finish

A set containing A100 drills of different metric diameters in a cleverly designed rotating dispenser which makes selecting the required size very simple. Rotate the clear plastic top, until the required size is highlighted by the hole in the case, and turn the set upside down to remove the drill.

HSS	DIN 338	4xD
118°	ST	
λ 20-35°	R	DC h8

A=Styles in Set, B=No. in Set, C=Diameters in Set. DC <= 1mm; 3/64"; N60 Bright.

Product	Nr.	A	B	C
A191413	413	A100	13	1.5 mm - 6.5 mm x 0.5 mm + 3.3 mm, 4.2 mm
A191419	419	A100	19	1.0 mm - 10.0 mm x 0.5 mm

A188



HSS Jobber Drill Set with A108 Drills, Steam Tempered Finish

A set of different fractional sizes of our A108 drills in a useful plastic storage case. Can be used in many different machine and hand-held applications.

HSS	DIN 338	4×D
135°	ST	
λ>35°	R	

A=Styles in Set, B=No. in Set, C=Diameters in Set. DC > 1.5mm; 1/16" Split Point

Product	Nr.	A	B	C
A188201	201	A108	19	1.0 mm - 10.0 mm x 0.5 mm
A188204	204	A108	25	1.0 mm - 13.0 mm x 0.5 mm

A295



HSS-E (8% Cobalt) Jobber Drill Set with A777 Drills, Bronze Surface Finish

A set of different fractional sizes of our A777 drills in a useful plastic storage case. The set keeps all of the drills together in order, with sizes clearly displayed for easy selection. The A777 drills are designed with a 135° split point to help self-center the drill and reduce the cutting forces.

HSS-E	DIN 338	4×D
135°	Bronze	
λ20-35°	R	DC h8

A=Styles in Set, B=No. in Set, C=Diameters in Set. DC ≤ 1.4mm 4 Facet Point.

Product	Nr.	A	B	C
A295219	219	A777	19	1.0 mm - 10.0 mm x 0.5 mm
A295225	225	A777	25	1.0 mm - 13.0 mm x 0.5 mm

DRILLING FEED RATE CHART

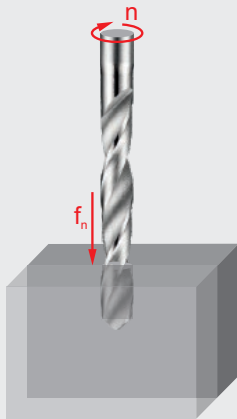

Feed per revolution (f_n in mm/rev)
Depending on the working conditions
it might be necessary to adjust these
values $\pm 25\%$.

How to use this table to find the feed per revolution (f_n):

1. Find your Alpha Code on the product page (example: 46J, "J" is the Alpha Code).
2. Find the closest diameter for your cutting application in the top row of the table.
3. Find your Alpha Code in the left column of the table.
4. The intersection (cell) of the Diameter and Alpha Code is the feed per revolution (f_n).

		\varnothing DC [mm]																		
		0.15	0.50	1.00	2.00	3.00	4.00	5.00	6.00	8.00	10.00	12.00	15.00	16.00	20.00	25.00	30.00	40.00	50.00	100.00
Feed rates	A	0.003	0.006	0.012	0.023	0.029	0.032	0.036	0.042	0.054	0.062	0.069	0.082	0.086	0.110	0.125	0.135	0.155	0.175	0.263
	B	0.004	0.007	0.014	0.028	0.037	0.041	0.046	0.053	0.067	0.080	0.090	0.103	0.108	0.135	0.153	0.165	0.188	0.208	0.312
	C	0.004	0.008	0.015	0.032	0.044	0.050	0.056	0.064	0.080	0.098	0.110	0.125	0.130	0.160	0.180	0.195	0.220	0.240	0.360
	D	0.004	0.008	0.016	0.038	0.053	0.060	0.068	0.078	0.098	0.119	0.130	0.149	0.155	0.188	0.210	0.228	0.253	0.275	0.413
	E	0.004	0.009	0.017	0.043	0.062	0.071	0.080	0.092	0.115	0.140	0.150	0.173	0.180	0.215	0.240	0.260	0.285	0.310	0.465
	F	0.005	0.009	0.018	0.050	0.073	0.084	0.095	0.109	0.138	0.165	0.178	0.202	0.210	0.248	0.275	0.295	0.320	0.343	0.515
	G	0.005	0.010	0.019	0.056	0.084	0.096	0.109	0.126	0.160	0.190	0.205	0.231	0.240	0.280	0.310	0.330	0.355	0.375	0.563
	H	0.005	0.010	0.020	0.066	0.102	0.116	0.130	0.150	0.190	0.228	0.243	0.271	0.280	0.320	0.355	0.375	0.398	0.418	0.627
	I	0.005	0.011	0.021	0.076	0.119	0.134	0.150	0.173	0.220	0.265	0.280	0.310	0.320	0.360	0.400	0.420	0.440	0.460	0.690
	J	0.006	0.012	0.024	0.084	0.135	0.152	0.170	0.197	0.250	0.298	0.315	0.349	0.360	0.405	0.445	0.465	0.485	0.503	0.755
	K	0.007	0.013	0.026	0.092	0.150	0.170	0.190	0.220	0.280	0.330	0.350	0.388	0.400	0.450	0.490	0.510	0.530	0.545	0.818
	L	0.007	0.014	0.028	0.101	0.165	0.186	0.208	0.240	0.305	0.360	0.385	0.419	0.430	0.485	0.525	0.545	0.568	0.588	0.882
	M	0.008	0.015	0.030	0.110	0.180	0.202	0.225	0.260	0.330	0.390	0.420	0.450	0.460	0.520	0.560	0.580	0.605	0.630	0.945
	N	0.008	0.016	0.032	0.119	0.195	0.218	0.242	0.280	0.355	0.420	0.455	0.481	0.490	0.555	0.595	0.615	0.642	0.672	1.008
	S	0.002	0.004	0.008	0.014	0.020	0.025	0.030	0.037	0.050	0.080	0.100	0.123	0.130	0.150	0.170	0.190	0.220	0.240	–
	T	0.004	0.008	0.015	0.028	0.040	0.050	0.060	0.070	0.090	0.110	0.130	0.160	0.170	0.190	0.210	0.230	0.260	0.275	–
	U	0.007	0.013	0.026	0.048	0.070	0.080	0.090	0.107	0.140	0.170	0.200	0.223	0.230	0.240	0.270	0.300	0.360	0.375	–
	V	0.010	0.019	0.038	0.069	0.100	0.115	0.130	0.153	0.200	0.250	0.280	0.310	0.320	0.340	0.400	0.440	0.510	0.530	–
	W	0.012	0.025	0.049	0.089	0.130	0.150	0.170	0.200	0.260	0.330	0.380	0.418	0.430	0.450	0.470	0.490	0.520	0.540	–
	X	0.014	0.028	0.056	0.103	0.150	0.180	0.210	0.250	0.330	0.420	0.480	0.533	0.550	0.580	–	–	–	–	–
Y	0.017	0.034	0.068	0.124	0.180	0.220	0.260	0.317	0.430	0.550	0.700	0.700	0.700	0.740	–	–	–	–	–	
Z	0.024	0.047	0.094	0.172	0.250	0.325	0.400	0.533	0.800	1.000	1.100	1.175	1.200	1.200	–	–	–	–	–	

The image features a complex, abstract technical diagram. It consists of a central cluster of interconnected hexagons in various shades of gray, white, and orange. These hexagons are surrounded by a network of thin, light gray lines and arrows, suggesting a flow or process. The background is a light gray gradient with faint, larger-scale geometric shapes and lines, creating a sense of depth and technical precision. The overall aesthetic is clean, modern, and industrial.

DRILLS
TECHNICAL INFORMATION

Drill Nomenclature

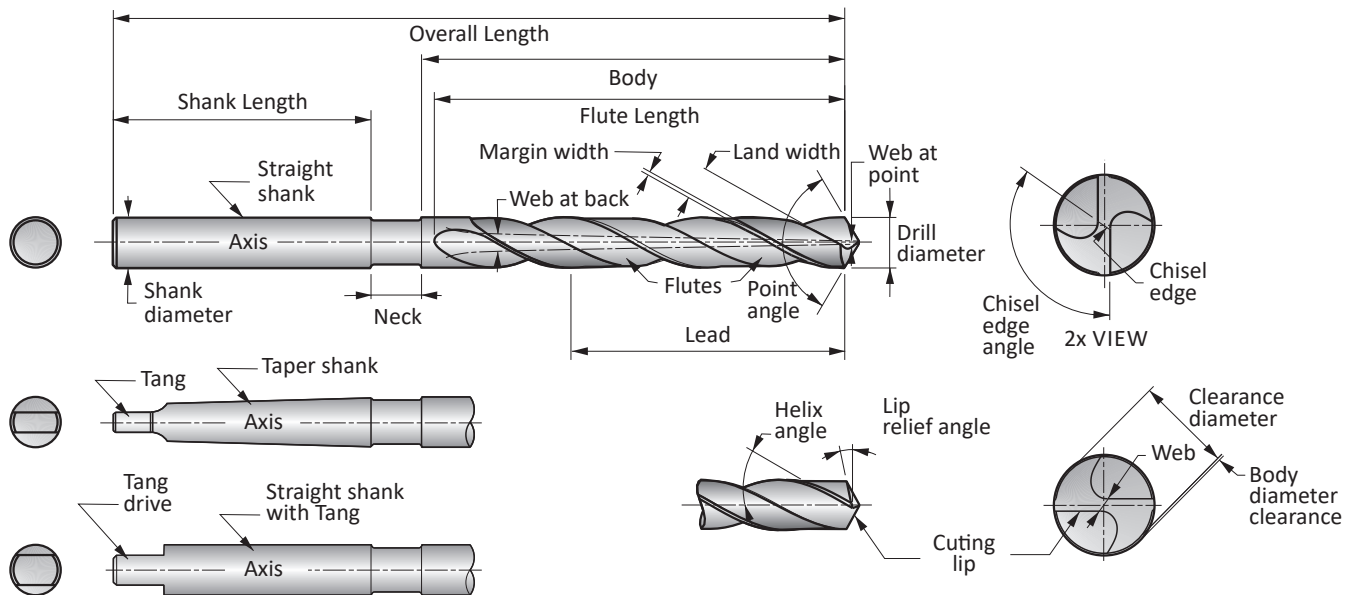

- **Axis** — The imaginary straight line which forms the longitudinal centre line of a drill.
- **Backtaper** — A slight decrease in diameter from front to back in the body of a drill.
- **Body** — The portion of a drill extending from the shank or neck to the outer corners of the cutting lips.
- **Body Clearance Diameter** — The portion of the land that has been cut away so it will not bind against the walls of the hole.
- **Chisel-Edge** — The edge at the end of the web that connects the cutting lips.
- **Chisel-Edge Angle** — The included angle between the chisel-edge and cutting lip, as viewed from the end of a drill.
- **Clearance Diameter** — The diameter over the cut away portion of the drill lands.
- **Drill** — A rotary end cutting tool having one or more cutting lips, and having one or more helical or straight flutes for the passage of chips and the admission of a cutting fluid.
- **Drill Diameter** — The diameter over the margins of a drill measured at the point.
- **Flute Length** — The length from the outer corners of the cutting lips to the extreme back of the flutes. Includes the sweep of the tool used to generate the flutes and therefore does not indicate the usable length of flutes.
- **Flutes** — Helical or straight grooves cut or formed in the body of a drill to provide cutting lips, permit removal of chips, and allow cutting fluid to reach the cutting lips.
- **Helix Angle** — The angle formed by the leading edge of the land with a plane containing the axis of a drill.
- **Land** — The peripheral portion of the body between adjacent flutes.
- **Land Width** — The distance between the leading edge and heel of the land; measured at a right angle to the leading edge.
- **Lead** — The axial advance of a leading edge of the land in one turn around the circumference.
- **Lip Relief Angle** — The axial relief angle at the outer corner of the lip; measured by projection to a plane tangent to the periphery at the outer corner of the lip.
- **Lips** — The cutting edges of a two flute drill extending from the chisel-edge to the periphery.
- **Margin** — The cylindrical portion of the land, which is not cut away, to provide clearance.
- **Neck** — The section of reduced diameter between the body and the shank of a drill.
- **Overall Length** — The length from the extreme end of the shank to the outer corners of the cutting lip. It does not include the conical shank end often used on straight shank drills, nor the conical cutting point used on both straight and taper shank drills.
- **Point** — The cutting end of a drill, made up of the ends of the lands and the web. In form, it resembles a cone, but departs from a true cone to furnish clearance behind the cutting lips.
- **Conventional** — Conventional Points with 118° included point angles are the most commonly used because they provide satisfactory results in a wide variety of materials. A possible limitation is that the straight chisel edge contributes to wandering at the drill point, often making it necessary to spot the hole for improved accuracy.

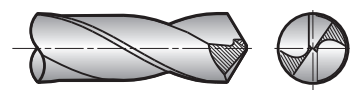
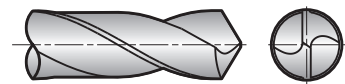

SOLID CARBIDE & HSS DRILLS – TECHNICAL INFO

- **Notched** — Notched Points were developed for drilling tough alloys. Commonly incorporated on heavy web drills, which allow the point to withstand the higher thrust loads required in drilling these materials. As with the split-point, the Notched Point contains two additional positive rake cutting edges extending toward the centre of the drill. These secondary cutting lips, which extend no further than half the original cutting lip, can assist in chip control and reduce the torque required in drilling tough materials. Notched Points can be incorporated on both 118° and 135° included point angles, making them suitable for drilling a wide variety of materials.

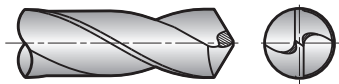

- **Point Angle** — The included angle between the cutting lips projected upon a plane parallel to the drill axis and parallel to the two cutting lips.
- **Relative Lip Height** — The difference in indicator reading between the cutting lips of a drill. Measured at a right angle to the cutting lip at a specific distance from the axis of the tool.
- **Shank** — The part of a drill by which it is held and driven.
- **Tang** — The flattened end of a taper shank, intended to fit into a driving slot in a socket.
- **Tang Drive** — Two opposite parallel driving flats on the extreme end of a straight shank.
- **Taper Shank** — Drills having conical shanks suitable for direct fitting in machine spindles, driving sleeves, or sockets. Tapered shanks generally have a tang.
- **Web** — The central portion of the body that joins the lands. The extreme end of the web forms the chisel-edge on a two flute drill.
- **Web Thickness** — The thickness of the web at the point, unless another specific location is indicated.

General hints on drilling

1. Select the most appropriate drill for the application, bearing in mind the material to be machined, the capability of the machine tool and the coolant to be used.
2. Flexibility within the component and machine tool spindle can cause damage to the drill as well as the component and machine - ensure maximum stability at all times. This can be improved by selecting the shortest possible drill for the application.
3. Tool holding is an important aspect of the drilling operation and the drill cannot be allowed to slip or move in the tool holder.
4. The correct use of Morse Taper Shank drills relies on an efficient fit between the taper surfaces of the tool and the tool holder. The use

of a soft-faced hammer should be used to drive the drill into the holder.

5. The use of suitable coolants and lubricants are recommended as required by the particular drilling operation. When using coolants and lubricants, ensure a copious supply, especially at the drill point.
6. Swarf evacuation whilst drilling is essential in ensuring the correct drilling procedure. Never allow the swarf to become stationary in the flute.
7. When regrinding a drill, always make sure that the correct point geometry is produced and that any wear has been removed.

SOLID CARBIDE & HSS DRILLS – TECHNICAL INFO

Deep hole drilling strategy

When drilling deep holes, several methods can be adopted to achieve the depth required. The example below shows four ways of drilling a hole with 10× the diameter of the drill.

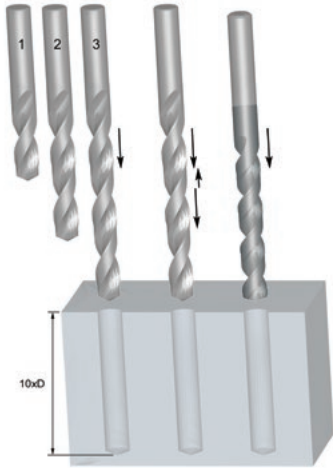

	Series Drilling	Series Drilling
No of drills	3 (2.5×D, 6×D, 10×D)	2 (2.5×D, 10×D)
Type of drill	Standard geometry, general purpose	Standard geometry, general purpose
+ / -	Expensive Time consuming	More cost effective Quick

	Peck Drilling	Single Pass Drilling
No of drills	1 (10×D)	1 (10×D)
Type of drill	Standard geometry, general purpose	Purpose specific tools
+ / -	Time consuming	Cost effective Fast

Trouble shooting when drilling

Problem	Cause	Remedy
Broken or twisted tangs	Bad fit between shank and socket	Ensure the shank and socket are clean and free from damage
Splitting of the web	Feed too high	Reduce feed to optimum rate
	Insufficient initial clearance	Regrind to correct specification
	Excessive web thinning	Regrind to correct specification
	Heavy impact at point of drill	Avoid impact at the point of drill. Take care with taper shank drills when inserting/ ejecting from spindle
Worn outer corner	Excessive speed	Reduce speed to optimum - may be able to increase feed
Broken outer corners	Unstable component set up	Reduce movement in the component
Chipped cutting lips	Excessive initial clearance	Regrind to correct specification
Breakage at flute run out	Choking of flutes	Adopt a peck/series drilling concept
	Drill slipping	Ensure the drill is held securely in the chuck and spindle
Spiral finish in hole	Insufficient feed	Increase feed
	Bad positional accuracy	Use a spot drill before drilling
Hole size too large	Incorrect point geometry	Check point geometry
	Ineffective swarf clearance	Adjust speed, feed and peck length to achieve more manageable swarf



SOLID CARBIDE & HSS DRILLS – TECHNICAL INFO

Hole Size / Achievable Hole Tolerances

As geometric, substrate and coating configurations become more advanced, the ability of a drill to produce a more accurate hole size increases. In general, a standard geometry tool will achieve a hole

size to H12. However as the configuration of the drill becomes more complex the achievable hole size, under favorable conditions, can be as good as H8.

To offer a better insight, listed below are the product types and their achievable hole tolerances:

HSS General Purpose drills – H12

HSS / HSCo Parabolic Flute Deep Hole Drills (PFX) – H10

HSS / HSCo High performance TiN/ TiAlN coated (ADX) – H9

Solid Carbide High Performance TiN / TiAlN coated (CDX, Force) – H8

Nominal Hole Diameter (mm)

Ø [mm]	H8	H9	H10	H12
≤ 3	0 / +0.014	0 / +0.025	0 / +0.040	0 / +0.100
> 3 ≤ 6	0 / +0.018	0 / +0.030	0 / +0.048	0 / +0.120
> 6 ≤ 10	0 / +0.022	0 / +0.036	0 / +0.058	0 / +0.150
> 10 ≤ 18	0 / +0.027	0 / +0.043	0 / +0.070	0 / +0.180
> 18 ≤ 30	0 / +0.033	0 / +0.052	0 / +0.084	0 / +0.210

Nominal Hole Diameter (inches)

Ø [inch]	H8	H9	H10	H12
≤ .1181	0 / +0.0006"	0 / +0.0010"	0 / +0.0016"	0 / +0.0040"
>.1181≤.2362	0 / +0.0007"	0 / +0.0012"	0 / +0.0019"	0 / +0.0048"
>.2362≤.3937	0 / +0.0009"	0 / +0.0015"	0 / +0.0023"	0 / +0.0059"
>.3937≤.7087	0 / +0.0011"	0 / +0.0017"	0 / +0.0028"	0 / +0.0071"
>.7087≤1.1811	0 / +0.0013"	0 / +0.0021"	0 / +0.0033"	0 / +0.0083"

In view of the ability of some drills to produce a much tighter hole tolerance, due consideration should be given to drilled holes which are subject to secondary operations, eg. tapping, reaming. The diameter

of the drill will need to be increased from what is recommended to account for the fact that the hole size produced will be smaller.

Optimizing the Drilling Operation / Troubleshooting

Drill Selection

Use the shortest drill the application will permit in order to achieve maximum tool rigidity.

HOLDERS

Tool holders and collets must provide good concentricity between the drill and the machine spindle. Use a positive back stop to prevent the tool from backing up into the holder. Never clamp the tool over the flutes or over-tighten the holder. Static runout in the tool assembly must be accurately checked and maintained.

Workpiece

A secure and rigid workpiece to minimize deflection is needed, particularly on through-hole applications.



Coolants

Coolants are recommended when drilling mild steel and high temperature alloys. The purpose of the coolant media is to direct the chips away from the cutting tool and workpiece. Excessive coolant pressure and/or too much volume can negatively affect performance. When using coolant fed drills, the coolant pressure that is required should be higher than normal. Suggested pressure for coolant fed drills is minimally 10.3 bar or 150 PSI. As the diameter of the drill is reduced, the higher the pressure. This is to assist the chip in evacuating from a more confined area.

Drilling Troubleshooting Guide

Problem	Solution
Wear on Outer Corners	Reduce cutting speed
	Increase feed (IPR)
	Improve direction of coolant flow
	Increase coolant pressure
	Add corner break
Chipping of Chisel Edge	Check accuracy of drill runout
	Check workpiece clamping accuracy and movement
	Check point centrality and lip height
	Increase feed rate
Chipping of Cutting Lips	Check accuracy of drill runout
	Check workpiece clamping accuracy and movement
	Reduce speed
	Reduce point clearance
	Increase hone
Cracking of Lands	Check movement of workpiece
	Increase back taper
	Check accuracy of drill runout
	Chip packing; increase flute form opening or peck drill (HSS or HSCO only)
	Slow down helix, horizontal drilling
	Increase feed
	When spot drilling, reduce feed
	Improve direction of coolant flow
Increase coolant pressure	
Oversize Hole	Increase speed, reduce feed
	Check workpiece clamping accuracy and movement
	Check accuracy of drill runout
	Chip packing, increase flute form opening or peck drill (HSS or HSCO only)
	Check point centrality and lip height
Undersize Hole	Improve direction of coolant flow
	Reduce cutting speed, increase feed
	Check drill diameter
Hole Not Round	Check accuracy of drill runout
	Check workpiece clamping accuracy and movement
	Check point centrality and lip height
	Chip packing, increase flute form opening or peck drill (HSS or HSCO only)
Drill Breakage	Chip packing, increase flute form opening or peck drill (HSS or HSCO only)
	Check workpiece clamping accuracy and movement
	Check accuracy of drill runout
	Reduce feed rate, increase feed rate
	Improve direction of coolant flow
	Increase coolant pressure

GENERAL – TECHNICAL INFO

	Grade	Hardness (HV10)	C %	W %	Mo %	Cr %	V %	Co %	Tool Material
	M2	810 – 850	0.9	6.4	5.0	4.2	1.8	–	HSS
	M35	830 – 870	0.93	6.4	5.0	4.2	1.8	4.8	HSCO
	M42	870 – 960	1.08	1.5	9.4	3.9	1.2	8.0	





Properties	HSS materials	Carbide materials	K10/30F (often used for solid tools)
Hardness [HV30]	800-950	1300 – 1800	1600
Density [g/cm ³]	8.0 – 9.0	7.2 – 15	14.45
Compressive strength [N/mm ²]	3000 – 4000	3000 – 8000	6250
Flexural strength, (bending) [N/mm ²]	2500 – 4000	1000 – 4700	4300
Heat resistance [°C]	550	1000	900
E-module [KN/mm ²]	260 – 300	460 – 630	580
Grain size [µm]	–	0.2 – 10	0.8

The combination of hard particle (WC) and binder metal (Co) give the following changes in characteristics.

Characteristic	Higher WC content give	Higher Co content give
Hardness	Higher hardness	Lower hardness
Compressive strength [CS]	Higher CS	Lower CS
Bending strength [BS]	Lower BS	Higher BS

Grain size also influences the material properties. Small grain sizes means higher hardness and coarse grains give more toughness.

Surface treatment / Coating properties examples

Surface Treatments	Colour	Coating material	Hardness [HV]	Thickness [µm]	Coating structure	Frict. coeff. against steel	Max. appl. temp. [°C]
	Dark grey	Fe ₃ O ₄	400	Max. 5	Conversion into the surface	–	550
	Bronze	Fe ₃ O ₄	400	Max. 5	Conversion into the surface	–	550
	Gold	TiN	2300	1 – 4	Mono-layer	0.4	600
	Black grey	TiAlN	3300	3	Nano structured	0.3 – 0.35	900



GENERAL – TECHNICAL INFO

Industry Standard tolerances For Shafts & Holes

Tolerance values are shown in Microns (μm)

Formula for Microns ...1 $\mu\text{m} = 0.001 \text{ mm} / 0.000039''$

Tolerance	Diameter [mm]							
	> 1 ≤ 3	> 3 ≤ 6	> 6 ≤ 10	> 10 ≤ 18	> 18 ≤ 30	> 30 ≤ 50	> 50 ≤ 80	> 80 ≤ 120
	Diameter [inch]							
	> 0.039" ≤ 0.118"	> 0.118" ≤ 0.236"	> 0.236" ≤ 0.394"	> 0.394" ≤ 0.709"	> 0.709" ≤ 1.181"	> 1.181" ≤ 1.968"	> 1.968" ≤ 3.149"	> 3.149" ≤ 4.724"
	Tolerance values [μm]							
e8	-14 / -28	-20 / -38	-25 / -47	-32 / -59	-40 / -73	-50 / -89	-60 / -106	-72 / -126
f6	-6 / -12	-10 / -18	-13 / -22	-16 / -27	-20 / -33	-25 / -41	-30 / -49	-36 / -58
f7	-6 / -16	-10 / -22	-13 / -28	-16 / -34	-20 / -41	-25 / -50	-30 / -60	-36 / -71
h6	0 / -6	0 / -8	0 / -9	0 / -11	0 / -13	0 / -16	0 / -19	0 / -22
h7	0 / -10	0 / -12	0 / -15	0 / -18	0 / -21	0 / -25	0 / -30	0 / -35
h8	0 / -14	0 / -18	0 / -22	0 / -27	0 / -33	0 / -39	0 / -46	0 / -54
h9	0 / -25	0 / -30	0 / -36	0 / -43	0 / -52	0 / -62	0 / -74	0 / -87
h10	0 / -40	0 / -48	0 / -58	0 / -70	0 / -84	0 / -100	0 / -120	0 / -140
h11	0 / -60	0 / -75	0 / -90	0 / -110	0 / -130	0 / -160	0 / -190	0 / -220
h12	0 / -100	0 / -120	0 / -150	0 / -180	0 / -210	0 / -250	0 / -300	0 / -350
k10	+40 / 0	+48 / 0	+58 / 0	+70 / 0	+84 / 0	+100 / 0	+120 / 0	+140 / 0
k12	+100 / 0	+120 / 0	+150 / 0	+180 / 0	+210 / 0	+250 / 0	+300 / 0	+350 / 0
m7	+2 / +12	+4 / +16	+6 / +21	+7 / +25	+8 / +29	+9 / +34	+11 / +41	+13 / +48
js14	+/- 125	+/- 150	+/- 180	+/- 215	+/- 260	+/- 310	+/- 370	+/- 435
js16	+/- 300	+/- 375	+/- 450	+/- 550	+/- 650	+/- 800	+/- 950	+/- 1100
H7	+10 / 0	+12 / 0	+15 / 0	+18 / 0	+21 / 0	+25 / 0	+30 / 0	+35 / 0
H8	+14 / 0	+18 / 0	+22 / 0	+27 / 0	+33 / 0	+39 / 0	+46 / 0	+54 / 0
H9	+25 / 0	+30 / 0	+36 / 0	+43 / 0	+52 / 0	+62 / 0	+74 / 0	+87 / 0
H12	+100 / 0	+120 / 0	+150 / 0	+180 / 0	+210 / 0	+250 / 0	+300 / 0	+350 / 0
P9	-6 / -31	-12 / -42	-15 / -51	-18 / -61	-22 / -74	-26 / -86	-32 / -106	-37 / -124
S7	-13 / -22	-15 / -27	-17 / -32	-21 / -39	-27 / -48	-34 / -59	-42 / -72	-58 / -93



GENERAL – TECHNICAL INFO

Table of Cutting Speeds

		Vc															
m/min.		5	8	10	15	20	25	30	40	50	60	70	80	90	100	110	150
SFM (feet/min.)		16	26	32	50	66	82	98	130	165	197	230	262	296	330	362	495
Ø		RPM															
mm	inch																
1.00	–	1592	2546	3183	4775	6366	7958	9549	12732	15916	19099	22282	25465	28648	31831	35014	47747
1.50	–	1061	1698	2122	3183	4244	5305	6366	8488	10610	12732	14854	16977	19099	21221	23343	31831
2.00	–	796	1273	1592	2387	3183	3979	4775	6366	7958	9549	11141	12732	14324	15916	17507	23873
2.50	–	637	1019	1273	1910	2546	3183	3820	5093	6366	7639	8913	10186	11459	12732	14006	19099
3.00	–	531	849	1061	1592	2122	2653	3183	4244	5305	6366	7427	8488	9549	10610	11671	15916
3.18	1/8	500	801	1001	1501	2002	2502	3003	4004	5005	6006	7007	8008	9009	10010	11011	15015
3.50	–	455	728	909	1364	1819	2274	2728	3638	4547	5457	6366	7276	8185	9095	10004	13642
4.00	–	398	637	796	1194	1592	1989	2387	3183	3979	4775	5570	6366	7162	7958	8754	11937
4.50	–	354	566	707	1061	1415	1768	2122	2829	3537	4244	4951	5659	6366	7074	7781	10610
4.76	3/16	334	535	669	1003	1337	1672	2006	2675	3344	4012	4681	5350	6018	6687	7356	10031
5.00	–	318	509	637	955	1273	1592	1910	2546	3183	3820	4456	5093	5730	6366	7003	9549
6.00	–	265	424	531	796	1061	1326	1592	2122	2653	3183	3714	4244	4775	5305	5836	7958
6.35	1/4	251	401	501	752	1003	1253	1504	2005	2506	3008	3509	4010	4511	5013	5514	7519
7.00	–	227	364	455	682	909	1137	1364	1819	2274	2728	3183	3638	4093	4547	5002	6821
7.94	5/16	200	321	401	601	802	1002	1203	1604	2004	2405	2806	3207	3608	4009	4410	6013
8.00	–	199	318	398	597	796	995	1194	1592	1989	2387	2785	3183	3581	3979	4377	5968
9.00	–	177	283	354	531	707	884	1061	1415	1768	2122	2476	2829	3183	3537	3890	5305
9.53	3/8	167	267	334	501	668	835	1002	1336	1670	2004	2338	2672	3006	3340	3674	5010
10.00	–	159	255	318	477	637	796	955	1273	1592	1910	2228	2546	2865	3183	3501	4775
11.11	7/16	143	229	287	430	573	716	860	1146	1433	1719	2006	2292	2579	2865	3152	4298
12.00	–	133	212	265	398	531	663	796	1061	1326	1592	1857	2122	2387	2653	2918	3979
12.70	1/2	125	201	251	376	501	627	752	1003	1253	1504	1754	2005	2256	2506	2757	3760
14.00	–	114	182	227	341	455	568	682	909	1137	1364	1592	1819	2046	2274	2501	3410
14.29	9/16	111	178	223	334	446	557	668	891	1114	1337	1559	1782	2005	2228	2450	3341
15.00	–	106	170	212	318	424	531	637	849	1061	1273	1485	1698	1910	2122	2334	3183
15.88	5/8	100	160	200	301	401	501	601	802	1002	1203	1403	1604	1804	2004	2205	3007
16.00	–	99	159	199	298	398	497	597	796	995	1194	1393	1592	1790	1989	2188	2984
17.46	11/16	91	146	182	273	365	456	547	729	912	1094	1276	1458	1641	1823	2005	2735
18.00	–	88	141	177	265	354	442	531	707	884	1061	1238	1415	1592	1768	1945	2653
19.05	3/4	84	134	167	251	334	418	501	668	835	1003	1170	1337	1504	1671	1838	2506
20.00	–	80	127	159	239	318	398	477	637	796	955	1114	1273	1432	1592	1751	2387
24.00	–	66	106	133	199	265	332	398	531	663	796	928	1061	1194	1326	1459	1989
25.00	–	64	102	127	191	255	318	382	509	637	764	891	1019	1146	1273	1401	1910
27.00	–	59	94	118	177	236	295	354	472	589	707	825	943	1061	1179	1297	1768
30.00	–	53	85	106	159	212	265	318	424	531	637	743	849	955	1061	1167	1592
32.00	–	50	80	99	149	199	249	298	398	497	597	696	796	895	995	1094	1492
36.00	–	44	71	88	133	177	221	265	354	442	531	619	707	796	884	973	1326
40.00	–	40	64	80	119	159	199	239	318	398	477	557	637	716	796	875	1194
50.00	–	32	51	64	95	127	159	191	255	318	382	446	509	573	637	700	955



GENERAL – TECHNICAL INFO

Hardness and Tensile Strength

HV	HRC	HB	Tensile Strength	
			[N/mm ²]	[Tons/sq. in.]
940	68	–	–	–
900	67	–	–	–
864	66	–	–	–
829	65	–	–	–
800	64	–	–	–
773	63	–	–	–
745	62	–	–	–
720	61	–	–	–
698	60	–	–	–
675	59	–	–	–
655	58	–	2200	142
650	–	618	2180	141
640	–	608	2145	139
639	57	607	2140	138
630	–	599	2105	136
620	–	589	2070	134
615	56	584	2050	133
610	–	580	2030	131
600	–	570	1995	129
596	55	567	1980	128
590	–	561	1955	126
580	–	551	1920	124
578	54	549	1910	124
570	–	542	1880	122
560	53	532	1845	119
550	–	523	1810	117
544	52	517	1790	116
540	–	513	1775	115
530	–	504	1740	113
527	51	501	1730	112
520	–	494	1700	110
514	50	488	1680	109
510	–	485	1665	108
500	–	475	1630	105
497	49	472	1620	105
490	–	466	1595	103
484	48	460	1570	102
480	–	456	1555	101
473	47	449	1530	99
470	–	447	1520	98
460	–	437	1485	96
458	46	435	1480	96
450	–	428	1455	94
446	45	424	1440	93
440	–	418	1420	92

HV	HRC	HB	Tensile Strength	
			[N/mm ²]	[Tons/sq. in.]
434	44	413	1400	91
423	43	402	1360	88
413	42	393	1330	86
403	41	383	1300	84
392	40	372	1260	82
382	39	363	1230	80
373	38	354	1200	78
364	37	346	1170	76
355	36	337	1140	74
350	–	333	1125	73
345	35	328	1110	72
340	–	323	1095	71
336	34	319	1080	70
330	–	314	1060	69
327	33	311	1050	68
320	–	304	1030	67
317	32	301	1020	66
310	31	295	995	64
302	30	287	970	63
300	–	285	965	62
295	–	280	950	61
293	29	278	940	61
290	–	276	930	60
287	28	273	920	60
285	–	271	915	59
280	27	266	900	58
275	–	261	880	57
272	26	258	870	56
270	–	257	865	56
268	25	255	860	56
265	–	252	850	55
260	24	247	835	54
255	23	242	820	53
250	22	238	800	52
245	–	233	785	51
243	21	231	780	50
240	–	228	770	50
235	–	223	755	49
230	–	219	740	48
225	–	214	720	47
220	–	209	705	46
215	–	204	690	45
210	–	199	675	44
205	–	195	660	43
200	–	190	640	41

**REAMERS
AND COUNTERSINKS**



1 B100



HSS Straight Shank Hand Reamer with H7 Accuracy, Bright and ST Finish
 Primarily designed for reaming by hand. It has a precision ground, left-hand helix with right-hand (clockwise) cutting for smooth reaming, creating a more accurate hole size and good surface finish. Suitable for reaming many materials, including steels.

2

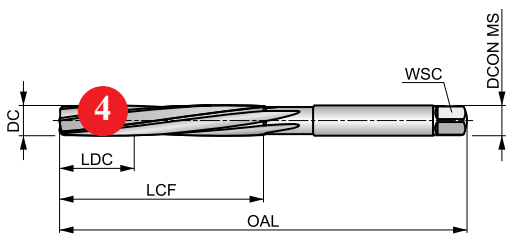

HSS	Bright ST	DIN 206
R		B
H7		

5

Workpiece material group suitability, starting values for cutting speed (m/min) and feed Alpha Code. Tables with feed per revolution can be found starting from page 90.

P1.1	P1.2	P1.3	P2.1	P2.2	P2.3	P3.1	P3.2	P3.3	P4.1	P4.2	P4.3	M1.1	M1.2
■	■	■	■	■	■	■	■	■	■	■	■	■	■
M2.1	K1.1	K1.2	K1.3	K2.1	K2.2	K2.3	K3.1	K3.2	N1.1	N1.2	N1.3	N2.1	N2.2
■	■	■	■	■	■	■	■	■	■	■	■	■	■
N2.3	N3.1	N3.2	N3.3	N4.1	N4.2								
■	■	■	■	■	■								

6

DCON MS tolerance e9.

Product	DC (inch)	DC (mm)	OAL (mm)	LCF (mm)	LDC (mm)	NOF	WSC (mm)	DCON MS (mm)
B1001.5	–	1.50	41.0	20.0	5.00	3	1.12	1.50
B1001/16	1/16	1.59	41.0	20.0	5.00	3	1.12	1.59
B1001.6	–	1.60	44.0	21.0	5.00	3	1.25	1.60
B1005/64	5/64	1.98	47.0	23.0	6.00	4	1.40	1.98
B1002.0	–	2.00	50.0	25.0	6.00	4	1.60	2.00
B1003/32	3/32	2.38	54.0	27.0	7.00	4	1.80	2.38
B1002.5	–	2.50	58.0	29.0	7.00	4	2.10	2.50
B1007/64	7/64	2.78	62.0	31.0	8.00	6	2.10	2.78
B1003.0	–	3.00	62.0	31.0	8.00	6	2.40	3.00
B1003.1	1/8	3.18	66.0	33.0	8.00	6	2.40	3.18
B1003.2	–	3.20	66.0	33.0	8.00	6	2.40	3.20
B1003.5	–	3.50	71.0	35.0	9.00	6	2.70	3.50

7

8

Pos.	Description
1	Designation of drill
2	Product description
3	Illustrative picture
4	Schematic drawing of tool

Pos.	Description
5	Product features
6	Material group recommendations incl. speed and feed guidance
7	Product code
8	Product dimensions

Typical page with reamers/countersinks displayed – specific page details will differ.



REAMERS AND COUNTERSINKS – ICONS OVERVIEW

GENERAL ICONS

	Primary use
	Possible use

ACHIEVABLE HOLE TOLERANCE ZONE (TCHA)

	H7 – Industry Standard Hole Tolerance Zone (based on diameter range)
	k11 – Industry Standard Tool Tolerance Zone (based on diameter range)

Application Angle

	100° Countersink		60° Countersink		90° Countersink
	20° Conical Drill		82° Countersink		

BASIC STANDARD GROUP (BSG)

	BS 328 – Drills and Reamers Standards		DIN 219 – Shell Reamer Standards		DIN 335 C – Straight Shank Countersink Standards
	DIN 206 – Hand Reamer Standards		DIN 311 – Morse Taper Shank Bridge Reamer Standards		DIN 335 D – Morse Taper Shank Countersink Standards
	DIN 208 – Morse Taper Shank Chucking Reamer Standards		DIN 334 C – Straight Shank Countersink Standards		DIN 9 – Taper Pin Reamer Standards
	DIN 217 – Shell Reamer Arbor Standards		DIN 335 A – Straight Shank Countersink Standards		Dormer Standards

COATING

	Aluminium Titanium Carbon Nitride Coating		Combination Bright and Steam Oxide		Titanium Aluminium Nitride Coating
	Bright (uncoated)		Steam and Bronze Oxide Surface Treatment		Titanium Nitride Coated

CUTTING DIRECTION

	Right Hand Rotation / Cutting
--	-------------------------------

MATERIAL CODE (BMC)

	High Speed Cobalt Steel Tool Material		High Speed Steel Tool Material
--	---------------------------------------	--	--------------------------------

REAMERS AND COUNTERSINKS – ICONS OVERVIEW

REAMER FORM

A	DIN Form A – Straight Flute ≤ Ø3.5mm
B	DIN Form B – Spiral Flute ≤ Ø3.5mm

SHANK

	Cylindrical Shank / Straight Shank		Cylindrical Shank with Square
	Cylindrical Shank with 3flat		DIN 6535 HA Cylindrical Shank
	Cylindrical Shank with Hex		Morse Taper Shank

TAPER GRADIENT (RATE OF TAPER)

1:48 	Taper Gradient (1/4" per foot taper)	1:50 	Taper Gradient (1 mm per 50 mm taper)
--	--------------------------------------	--	---------------------------------------

REAMERS AND COUNTERSINKS – NAVIGATOR TOOL MATERIALS

Tool materials		
High Speed Steel		A medium-alloyed high speed steel that has good machinability and good performance. HSS exhibits hardness, toughness and wear resistance characteristics that make it attractive in a wide range of applications, for example in drills and taps.
Cobalt High Speed Steel		This high speed steel contains cobalt for increased hot hardness. The composition of HSCo is a good combination of toughness and hardness. It has good machinability and good wear resistance, which makes it usable for drills, taps, milling cutters and reamers.
Surface Coatings		
Titanium Nitride (TiN)		Titanium Nitride is a gold coloured ceramic coating applied by physical vapour deposition (PVD). High hardness combined with low friction properties ensures considerably longer tool life, or alternatively, better cutting performance from tools which have not been coated. TiN coating is used mainly for drills and taps.
Aluminium Titanium Carbon Nitride (AlTiCN)		Aluminium Titanium Carbon-Nitride (AlTiCN) is a PVD coating which was specifically engineered to meet the rigorous requirements of the medical device industry. It is however equally applicable to certain cutting tool operations due to a high quality thin-film technology, with excellent micro-hardness and adhesion characteristics.
Titanium Aluminium Nitride coatings (TiAlN)		Titanium Aluminium Nitride is a multi layer ceramic coating applied by PVD coating technology, which exhibits high toughness and oxidation stability. These properties make it ideal for higher speeds and feeds, while at the same time improving tool life. TiAlN is used in drilling, tapping, and milling applications and can be suitable for use when machining without coolant.
Bright (uncoated)		Bright finish (uncoated surface) improves chip flow in soft or non-ferrous materials while maintaining sharp cutting edges.
Combination Bright and Steam Tempered		Combination of bright and steam tempering can be effective, as the blue oxide more porous surface acts to retain and pull cutting fluid into the hole while the bright surface assists in chip evacuation. This combination is achieved by grinding the bright surface after tempering.
Combination Steam and Bronze Tempered Surface Treatment		Combination of steam and bronze tempering can be effective, as the blue oxide more porous surface acts to retain and pull cutting fluid into the hole while the bronze surface assists in chip evacuation. Both surface treatments add a degree of surface protection to the tool. These combinations are achieved by using two different tempering cycles.



Material code (BMC)		HSS	HSS	HSS	HSS	HSS	HSS	HSS	HSS-E	HSS-E	HSS-E	HSS-E		
		Bright ST	Bright		Bright ST	Bright ST	Bright	ST Bronze	Bright ST	Bright ST	Bright	Bright ST	Bright	
Coating		DIN 206	DORMER	DORMER	BS 328	DIN 9	DIN 9	ANSI	DIN 311	BS 328	DIN 208	DIN 219	DIN 217	
		R	R		R	R	R	R	R	R	R	R	R	
Hand (Cutting direction)														
Shank		B			A	A	B			B	B	B		
		H7							k11	H7	H7	H7		
Reamer form														
Achievable hole tolerance (TCHA)														
Taper gradient - millimeter (Rate of taper)					1:48	1:50	1:50							
Product Family Code		B100	B334	B335	B301	B903	B952	B122	B121	B101	B161	B955	B956	B957
		1.50 - 50.00	N000 - N16	N000BLADES - N16NUT	1/16 - 1/2	1.50 - 20.00	1.20 - 50.00	3/8 - 1.1/16	10.00 - 30.00	3.00 - 2"	3.00 - 50.00	25.00 - 80.00	13.00 - 40.00	N3DRIVER - N9WASHER
		90	92	93	94	95	96	97	98	99	101	102	103	104
P	P1	■	■		■	■	■	■	■	■	■	■		
	P2	■	■		■	■	■	■	■	■	■	■		
	P3	☑	■		■	■	■	☑	■	■	■	■		
	P4	☑	☑		☑	☑	☑	☑	☑	☑	☑	☑		
M	M1	☑	☑		☑	☑	☑	☑		☑	☑	☑		
	M2	☑	☑		☑	☑	☑	☑		☑	☑	☑		
	M3													
	M4													
K	K1	■	■		■	☑	☑		■	■	■	■		
	K2	☑	■		■	■	■		■	■	■	■		
	K3	■	☑		☑	☑	☑		☑	☑	☑	☑		
	K4													
	K5													
N	N1	■	■		■	■	■	☑	■	■	■	■		
	N2	■	■		■	■	■	☑	■	■	■	■		
	N3	■	■		■	■	■	■	■	■	■	■		
	N4	☑	☑		☑	☑	☑	☑	☑	☑	☑	☑		
	N5													
S	S1													
	S2													
	S3													
	S4													
H	H1													
	H2													
	H3													
	H4													

■ Primary use ☑ Possible use



Material code (BMC)	HSS	HSS	HSS	HSS-E	HSS	HSS	HSS-E	HSS	HSS	HSS-E	HSS	HSS	
	Coating	Bright	Bright	Bright	Bright	Bright	TIAIN	ALTiCN	TIAIN	Bright	Bright	Bright	Bright
		Basic standard group (BSG)	DIN 335C	DIN 335C	DIN 335C	DORMER	DORMER	DIN 335C	DIN 335C	DIN 335C	DORMER	DORMER	DIN 335A
	Hand (Cutting direction)		R	R	R	R	R	R	R	R	R	R	R
		Shank											
	Application angle		90°	90°	90°	90°	90°	90°	90°	90°	90°	90°	90°
Product Family Code													
	G136	G142	G106	G107	G600	G560	G570	G506	G129	G149	G132	G135	
	4.30 - 31.00	4.80 - 31.00	6.30 - 50.00	6.30 - 20.50	6.30 - 25.00	6.30 - 31.00	6.30 - 31.00	6.30 - 50.00	6.00 - 31.50	5.00 - 50.00	8.00 - 20.00	6.30 - 25.00	
P	P1	■	■	■	■	■	■	■	■	■	■	■	
	P2	■	■	■	■	■	■	■	■	■	■	■	
	P3	■	■	■	■	■	■	■	■	■	■	■	
	P4	■	■	■	■	■	■	■	■	■	■	■	
M	M1	■	■	■	■	■	■	■	■	■	■	■	
	M2	■	■	■	■	■	■	■	■	■	■	■	
	M3	■	■	■	■	■	■	■	■	■	■	■	
	M4	■	■	■	■	■	■	■	■	■	■	■	
K	K1	■	■	■	■	■	■	■	■	■	■	■	
	K2	■	■	■	■	■	■	■	■	■	■	■	
	K3	■	■	■	■	■	■	■	■	■	■	■	
	K4	■	■	■	■	■	■	■	■	■	■	■	
	K5	■	■	■	■	■	■	■	■	■	■	■	
N	N1	■	■	■	■	■	■	■	■	■	■	■	
	N2	■	■	■	■	■	■	■	■	■	■	■	
	N3	■	■	■	■	■	■	■	■	■	■	■	
	N4	■	■	■	■	■	■	■	■	■	■	■	
	N5	■	■	■	■	■	■	■	■	■	■	■	
S	S1	■	■	■	■	■	■	■	■	■	■	■	
	S2	■	■	■	■	■	■	■	■	■	■	■	
	S3	■	■	■	■	■	■	■	■	■	■	■	
	S4	■	■	■	■	■	■	■	■	■	■	■	
H	H1	■	■	■	■	■	■	■	■	■	■	■	
	H2	■	■	■	■	■	■	■	■	■	■	■	
	H3	■	■	■	■	■	■	■	■	■	■	■	
	H4	■	■	■	■	■	■	■	■	■	■	■	

■ Primary use ■ Possible use

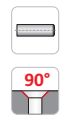
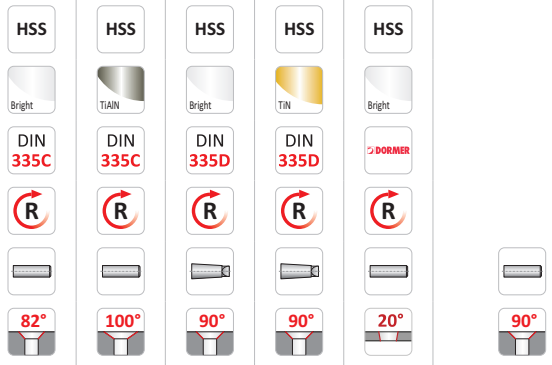

	G154	G171	G138	G338	G314	G236												
	6.30 - 25.00	6.30 - 25.00	25.00 - 80.00	25.00 - 63.00	4.00 - 9.00	Set												
	117	118	119	120	121	122												

P1	■	■	■	■	■													
P2	■	■	■	■	☐													
P3	■	■	☐	■	☐													
P4	☐	■	☐	■	■													
M1	☐	☐	☐	☐	☐													
M2	☐	☐	☐	☐	☐													
M3																		
M4																		
K1	☐	■	☐	■	☐													
K2	☐	■	☐	■	■													
K3	☐	■	☐	■	■													
K4		☐		☐	☐													
K5	☐	■	☐	■	■													
N1	☐	☐	☐	■	■													
N2	☐	■	☐	■	☐													
N3	■	■	■	■	■													
N4	☐	☐	☐	☐	■													
N5																		
S1																		
S2																		
S3																		
S4																		
H1																		
H2																		
H3																		
H4																		

B100



HSS Straight Shank Hand Reamer with H7 Accuracy, Bright and ST Finish

Primarily designed for reaming by hand. It has a precision ground, left-hand helix with right-hand (clockwise) cutting for smooth reaming, creating a more accurate hole size and good surface finish. Suitable for reaming many materials, including steels.

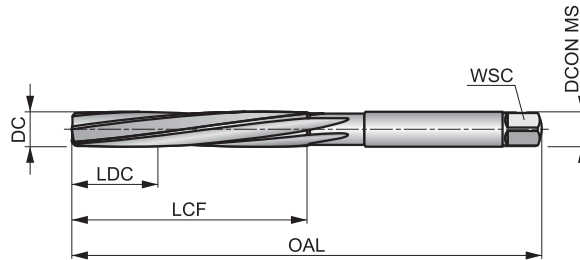

HSS	Bright ST	DIN 206
R		B
H7		

Workpiece material group suitability.

P1.1	P1.2	P1.3	P2.1	P2.2	P2.3	P3.1	P3.2	P3.3	P4.1	P4.2	P4.3	M1.1	M1.2
■	■	■	■	■	■	■	■	■	■	■	■	■	■
M2.1	K1.1	K1.2	K1.3	K2.1	K2.2	K2.3	K3.1	K3.2	N1.1	N1.2	N1.3	N2.1	N2.2
■	■	■	■	■	■	■	■	■	■	■	■	■	■
N2.3	N3.1	N3.2	N3.3	N4.1	N4.2								
■	■	■	■	■	■								

DCON MS tolerance e9.

Product	DC (inch)	DC (mm)	OAL (mm)	LCF (mm)	LDC (mm)	NOF	WSC (mm)	DCON MS (mm)
B1001.5	–	1.50	41.0	20.0	5.00	3	1.12	1.50
B1001/16	1/16	1.59	41.0	20.0	5.00	3	1.12	1.59
B1001.6	–	1.60	44.0	21.0	5.00	3	1.25	1.60
B1005/64	5/64	1.98	47.0	23.0	6.00	4	1.40	1.98
B1002.0	–	2.00	50.0	25.0	6.00	4	1.60	2.00
B1003/32	3/32	2.38	54.0	27.0	7.00	4	1.80	2.38
B1002.5	–	2.50	58.0	29.0	7.00	4	2.10	2.50
B1007/64	7/64	2.78	62.0	31.0	8.00	6	2.10	2.78
B1003.0	–	3.00	62.0	31.0	8.00	6	2.40	3.00
B1001/8	1/8	3.18	66.0	33.0	8.00	6	2.40	3.18
B1003.2	–	3.20	66.0	33.0	8.00	6	2.40	3.20
B1003.5	–	3.50	71.0	35.0	9.00	6	2.70	3.50
B1009/64	9/64	3.57	71.0	35.0	9.00	6	2.70	3.57
B1005/32	5/32	3.97	76.0	38.0	10.00	6	3.00	3.97
B1004.0	–	4.00	76.0	38.0	10.00	6	3.00	4.00
B10011/64	11/64	4.37	81.0	41.0	10.00	6	3.40	4.37
B1004.5	–	4.50	81.0	41.0	10.00	6	3.40	4.50
B1003/16	3/16	4.76	87.0	44.0	11.00	6	3.80	4.76
B1005.0	–	5.00	87.0	44.0	11.00	6	3.80	5.00
B10013/64	13/64	5.16	87.0	44.0	11.00	6	3.80	5.16
B1005.5	–	5.50	93.0	47.0	12.00	6	4.30	5.50
B1007/32	7/32	5.56	93.0	47.0	12.00	6	4.30	5.56
B10015/64	15/64	5.95	93.0	47.0	12.00	6	4.90	5.95
B1006.0	–	6.00	93.0	47.0	12.00	6	4.90	6.00
B1001/4	1/4	6.35	100.0	50.0	13.00	6	4.90	6.35
B1006.5	–	6.50	100.0	50.0	13.00	6	4.90	6.50
B10017/64	17/64	6.75	107.0	54.0	14.00	6	5.50	6.75



Product	DC	DC	OAL	LCF	LDC	NOF	WSC	DCON MS
	(inch)	(mm)	(mm)	(mm)	(mm)		(mm)	(mm)
B1007.0	–	7.00	107.0	54.0	14.00	6	5.50	7.00
B1009/32	9/32	7.14	107.0	54.0	14.00	6	6.20	7.14
B1007.5	–	7.50	107.0	54.0	14.00	6	6.20	7.50
B10019/64	19/64	7.54	115.0	58.0	15.00	6	6.20	7.54
B1005/16	5/16	7.94	115.0	58.0	15.00	6	6.20	7.94
B1008.0	–	8.00	115.0	58.0	15.00	6	6.20	8.00
B10021/64	21/64	8.33	115.0	58.0	15.00	6	7.00	8.33
B1008.5	–	8.50	115.0	58.0	15.00	6	7.00	8.50
B10011/32	11/32	8.73	124.0	62.0	16.00	6	7.00	8.73
B1009.0	–	9.00	124.0	62.0	16.00	6	7.00	9.00
B10023/64	23/64	9.13	124.0	62.0	16.00	6	8.00	9.13
B1009.5	–	9.50	124.0	62.0	16.00	6	8.00	9.50
B1003/8	3/8	9.52	124.0	62.0	17.00	6	8.00	9.52
B10025/64	25/64	9.92	133.0	66.0	17.00	6	8.00	9.92
B10010.0	–	10.00	133.0	66.0	17.00	6	8.00	10.00
B10013/32	13/32	10.32	133.0	66.0	17.00	6	8.00	10.32
B10010.5	–	10.50	133.0	66.0	17.00	6	8.00	10.50
B10011.0	–	11.00	142.0	71.0	18.00	6	9.00	11.00
B1007/16	7/16	11.11	142.0	71.0	18.00	6	9.00	11.11
B10011.5	–	11.50	142.0	71.0	18.00	6	9.00	11.50
B10012.0	–	12.00	152.0	76.0	19.00	6	9.00	12.00
B10012.5	–	12.50	152.0	76.0	19.00	6	10.00	12.50
B1001/2	1/2	12.70	152.0	76.0	19.00	6	10.00	12.70
B10013.0	–	13.00	152.0	76.0	19.00	6	10.00	13.00
B10017/32	17/32	13.49	163.0	81.0	20.00	8	11.00	13.49
B10013.5	–	13.50	163.0	81.0	20.00	8	11.00	13.50
B10014.0	–	14.00	163.0	81.0	20.00	8	11.00	14.00
B1009/16	9/16	14.29	163.0	81.0	20.00	8	11.00	14.29
B10014.5	–	14.50	163.0	81.0	20.00	8	11.00	14.50
B10015.0	–	15.00	163.0	81.0	20.00	8	12.00	15.00
B10019/32	19/32	15.08	163.0	81.0	22.00	8	12.00	15.08
B1005/8	5/8	15.88	175.0	87.0	22.00	8	12.00	15.88
B10016.0	–	16.00	175.0	87.0	22.00	8	12.00	16.00
B10017.0	–	17.00	175.0	87.0	22.00	8	13.00	17.00
B10011/16	11/16	17.46	188.0	93.0	23.00	8	14.50	17.46
B10018.0	–	18.00	188.0	93.0	23.00	8	14.50	18.00
B10019.0	–	19.00	188.0	93.0	23.00	8	14.50	19.00
B1003/4	3/4	19.05	188.0	93.0	25.00	8	14.50	19.05
B10020.0	–	20.00	201.0	100.0	25.00	8	16.00	20.00
B10013/16	13/16	20.64	201.0	100.0	25.00	8	16.00	20.64
B10021.0	–	21.00	201.0	100.0	25.00	8	16.00	21.00
B10022.0	–	22.00	215.0	107.0	27.00	8	18.00	22.00
B1007/8	7/8	22.22	215.0	107.0	27.00	8	18.00	22.22
B10023.0	–	23.00	215.0	107.0	27.00	8	18.00	23.00
B10024.0	–	24.00	231.0	115.0	29.00	8	18.00	24.00
B10025.0	–	25.00	231.0	115.0	29.00	8	20.00	25.00
B1001	1"	25.40	231.0	115.0	29.00	8	20.00	25.40
B10026.0	–	26.00	231.0	115.0	29.00	8	20.00	26.00
B10027.0	–	27.00	247.0	124.0	31.00	10	22.00	27.00
B10028.0	–	28.00	247.0	124.0	31.00	10	22.00	28.00
B10029.0	–	29.00	247.0	124.0	31.00	10	22.00	29.00
B10030.0	–	30.00	247.0	124.0	31.00	10	24.00	30.00
B10031.0	–	31.00	265.0	133.0	33.00	10	24.00	31.00
B10032.0	–	32.00	265.0	133.0	33.00	10	24.00	32.00
B10033.0	–	33.00	265.0	133.0	33.00	10	26.00	33.00
B10034.0	–	34.00	284.0	142.0	36.00	10	26.00	34.00
B10035.0	–	35.00	284.0	142.0	36.00	10	29.00	35.00
B10036.0	–	36.00	284.0	142.0	36.00	10	29.00	36.00
B10037.0	–	37.00	284.0	142.0	36.00	10	29.00	37.00
B10038.0	–	38.00	305.0	152.0	38.00	10	29.00	38.00
B10039.0	–	39.00	305.0	152.0	38.00	10	32.00	39.00
B10040.0	–	40.00	305.0	152.0	38.00	10	32.00	40.00
B10045.0	–	45.00	326.0	163.0	41.00	12	35.00	45.00
B10050.0	–	50.00	347.0	174.0	44.00	12	39.00	50.00

B334



HSS Straight Shank Adjustable Hand Reamer

This hand reamer is easily adjustable, helping to finish many different diameter holes with a single reamer. With precision ground blades and straight flute geometry, smooth reaming and improved hole size and surface finish are achieved. Suitable for reaming in many materials.

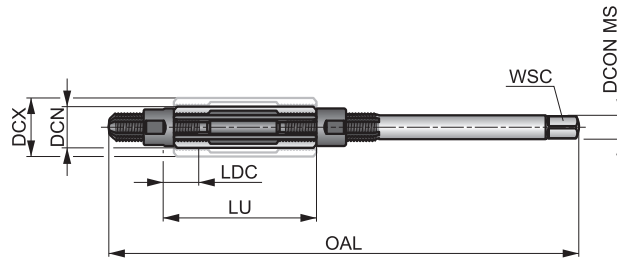

HSS	Bright	DORMER
R		

Workpiece material group suitability.

P1.1	P1.2	P1.3	P2.1	P2.2	P2.3	P3.1	P3.2	P3.3	P4.1	P4.2	P4.3	M1.1	M1.2
■	■	■	■	■	■	■	■	■	■	■	■	■	■
M2.1	K1.1	K1.2	K1.3	K2.1	K2.2	K2.3	K3.1	K3.2	N1.1	N1.2	N1.3	N2.1	N2.2
■	■	■	■	■	■	■	■	■	■	■	■	■	■
N2.3	N3.1	N3.2	N3.3	N4.1	N4.2								
■	■	■	■	■	■								

Product	Nr.	DCN	DCX	OAL	LU	LDC	NOF	WSC
		(mm)	(mm)	(mm)	(mm)	(mm)		
B334000	000	6.40	7.20	110.0	32.00	7.00	4	3.00
B33400	00	7.20	8.00	110.0	32.00	7.00	4	3.40
B3340	0	8.00	9.00	115.0	34.00	9.00	5	3.80
B3341	1	9.00	10.00	115.0	34.00	9.00	5	4.30
B3342	2	10.00	11.00	115.0	34.00	9.00	5	4.90
B3343	3	11.00	12.00	125.0	35.00	9.00	5	4.90
B3344	4	12.00	13.50	135.0	41.00	9.00	5	6.20
B3345	5	13.50	15.50	146.0	50.00	12.00	5	7.00
B3346	6	15.50	18.00	166.0	60.00	12.00	5	8.00
B3347	7	18.00	21.00	178.0	65.00	15.00	5	9.00
B3348	8	21.00	24.00	195.0	76.00	15.00	5	11.00
B3349	9	24.00	27.50	218.0	82.00	18.00	5	12.00
B33410	10	27.50	31.50	245.0	86.00	18.00	5	14.50
B33411	11	31.50	37.00	280.0	98.00	18.00	6	18.00
B33412	12	37.00	45.00	325.0	108.00	20.00	6	20.00
B33413	13	45.00	55.00	370.0	118.00	20.00	6	26.00
B33414	14	55.00	67.00	400.0	125.00	20.00	6	32.00
B33415	15	67.00	80.00	435.0	140.00	23.00	8	39.00
B33416	16	80.00	95.00	475.0	155.00	23.00	8	49.00

B335

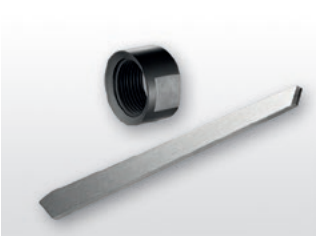

Replacement Blades and Nuts for Use in the Adjustable Hand Reamer, B334

The nut and blades can be purchased separately and are each available in 19 sizes.

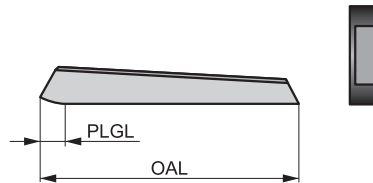

Product	Nr.	PLGL	OAL
		(mm)	(mm)
B335000BLADES	000	7.00	32.0
B335000NUT	000	–	–
B33500BLADES	00	7.00	32.0
B33500NUT	00	–	–
B3350BLADES	0	9.00	34.0
B3350NUT	0	–	–
B3351BLADES	1	9.00	34.0
B3351NUT	1	–	–
B3352BLADES	2	9.00	34.0
B3352NUT	2	–	–
B3353BLADES	3	9.00	35.0
B3353NUT	3	–	–
B3354BLADES	4	9.00	41.0
B3354NUT	4	–	–
B3355BLADES	5	12.00	50.0
B3355NUT	5	–	–
B3356BLADES	6	12.00	60.0
B3356NUT	6	–	–
B3357BLADES	7	15.00	65.0

Product	Nr.	PLGL	OAL
		(mm)	(mm)
B3357NUT	7	–	–
B3358BLADES	8	15.00	76.0
B3358NUT	8	–	–
B3359BLADES	9	18.00	82.0
B3359NUT	9	–	–
B33510BLADES	10	18.00	86.0
B33510NUT	10	–	–
B33511BLADES	11	18.00	98.0
B33511NUT	11	–	–
B33512BLADES	12	20.00	108.0
B33512NUT	12	–	–
B33513BLADES	13	20.00	118.0
B33513NUT	13	–	–
B33514BLADES	14	20.00	125.0
B33514NUT	14	–	–
B33515BLADES	15	23.00	140.0
B33515NUT	15	–	–
B33516BLADES	16	23.00	155.0
B33516NUT	16	–	–

B301



HSS Straight Shank Taper Pin Hand Reamer 1:48 Taper, Bright and ST Finish

Designed to finish tapered holes to accept standard 1 to 48 ratio imperial taper pins. With a reduced small diameter, the tool easily locates and centers in the pre-drilled hole to improve accuracy and performance. Suitable for reaming in many materials.

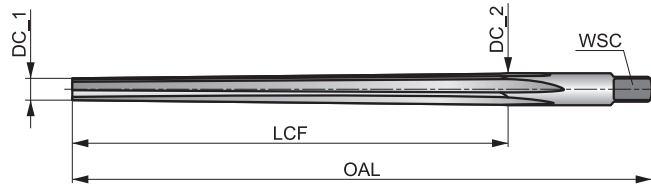

HSS	Bright ST	BS 328
R		A
1:48		

Workpiece material group suitability.

P1.1	P1.2	P1.3	P2.1	P2.2	P2.3	P3.1	P3.2	P3.3	P4.1	P4.2	P4.3	M1.1	M1.2
■	■	■	■	■	■	■	■	■	■	■	■	■	■
M2.1	K1.1	K1.2	K1.3	K2.1	K2.2	K2.3	K3.1	K3.2	N1.1	N1.2	N1.3	N2.1	N2.2
■	■	■	■	■	■	■	■	■	■	■	■	■	■
N2.3	N3.1	N3.2	N3.3	N4.1	N4.2								
■	■	■	■	■	■								

DC <= 1/4 limit of tolerance +0.0030; DC >= 9/32 limit of tolerance +0.0050.

Product	nom d	DC_1	DC_2	OAL	LCF	NOF	WSC	DCON MS
		(mm)	(mm)					
B3011/16	1/16	1.10	1.63	51.0	25.0	4	1.20	1.63
B3015/64	5/64	1.50	2.03	51.0	25.0	4	1.60	2.03
B3013/32	3/32	1.75	2.41	57.0	32.0	4	2.00	2.41
B3017/64	7/64	2.03	2.82	64.0	38.0	4	2.20	2.82
B3011/8	1/8	2.30	3.23	70.0	44.0	4	2.50	3.23
B3019/64	9/64	2.64	3.63	73.0	48.0	4	2.80	3.63
B3015/32	5/32	2.95	4.01	76.0	51.0	4	3.10	4.01
B30111/64	11/64	3.23	4.42	89.0	57.0	4	3.60	4.42
B3013/16	3/16	3.50	4.95	102.0	70.0	4	4.00	4.95
B3017/32	7/32	4.13	5.59	102.0	70.0	6	4.50	5.59
B3011/4	1/4	4.64	6.43	117.0	86.0	6	5.00	6.43
B3019/32	9/32	5.23	7.42	143.0	105.0	6	5.60	7.42
B3015/16	5/16	5.84	8.03	143.0	105.0	6	6.30	8.03
B30111/32	11/32	6.43	8.81	152.0	114.0	6	7.10	8.81
B3013/8	3/8	7.03	9.68	165.0	127.0	6	8.00	9.68
B30113/32	13/32	7.42	10.46	191.0	146.0	6	8.00	10.46
B3017/16	7/16	8.21	11.25	191.0	146.0	6	9.00	11.25
B3011/2	1/2	9.41	12.85	210.0	165.0	6	10.00	12.85

B903



HSS Straight Shank Taper Pin Hand Reamer 1:50 Taper, Bright and ST Finish

Designed to finish tapered holes to accept standard 1 to 50 ratio metric taper pins. The diameter of the small end is reduced to make it easier to locate and center the reamer in the hole. Suitable for reaming in many materials.

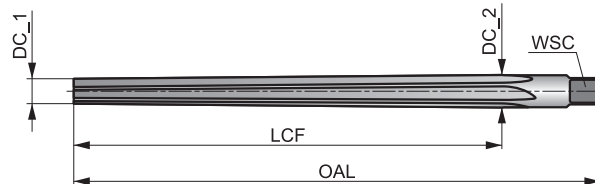

HSS	Bright ST	DIN 9
R		A
1:50		

Workpiece material group suitability.

P1.1	P1.2	P1.3	P2.1	P2.2	P2.3	P3.1	P3.2	P3.3	P4.1	P4.2	P4.3	M1.1	M1.2
■	■	■	■	■	☑	■	☑	☑	☑	☑	☑	☑	☑
M2.1	K1.1	K1.2	K1.3	K2.1	K2.2	K2.3	K3.1	K3.2	N1.1	N1.2	N1.3	N2.1	N2.2
☑	■	■	☑	■	■	☑	■	☑	☑	■	■	■	■
N2.3	N3.1	N3.2	N3.3	N4.1	N4.2								
☑	■	■	☑	☑	☑								

D CON MS tolerance h11; DC <= 5mm limmit of tolerance +0.0750; DC < 5mm limmit of tolerance +0.1250.

Product	nom d	DC_1	DC_2	OAL	LCF	NOF	WSC	D CON MS
		(mm)	(mm)	(mm)	(mm)		(mm)	(mm)
B9031.5	1.5	1.40	2.14	57.0	37.0	4	1.80	2.14
B9032.0	2.0	1.90	2.86	68.0	48.0	4	2.24	2.86
B9032.5	2.5	2.40	3.36	68.0	48.0	4	2.80	3.36
B9033.0	3.0	2.90	4.06	80.0	58.0	4	3.15	4.00
B9034.0	4.0	3.90	5.26	93.0	68.0	4	4.00	5.00
B9035.0	5.0	4.90	6.36	100.0	73.0	4	5.00	6.30
B9036.0	6.0	5.90	8.00	135.0	105.0	6	6.30	7.90
B9038.0	8.0	7.90	10.80	180.0	145.0	6	8.00	10.50
B90310.0	10.0	9.90	13.40	215.0	175.0	6	10.00	13.30
B90312.0	12.0	11.80	16.00	255.0	210.0	8	11.20	16.00
B90313.0	13.0	12.86	16.74	255.0	210.0	8	12.50	16.74
B90314.0	14.0	13.86	17.74	255.0	210.0	8	12.50	17.74
B90316.0	16.0	15.80	20.40	280.0	230.0	8	14.00	20.40
B90320.0	20.0	19.80	24.80	310.0	250.0	8	18.00	24.80

B952



HSS Straight Shank Taper Pin Hand Reamer 1:50 Taper, Bright Finish

With left-hand helix and right-hand cutting, gives smooth reaming for a more accurate hole size and better finish. The small end diameter has been reduced, making it easier to locate and center the reamer in the hole. Suitable for reaming in many materials.

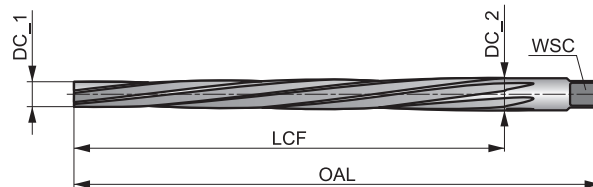

HSS	Bright	DIN 9
R		B
1:50		

Workpiece material group suitability.

P1.1	P1.2	P1.3	P2.1	P2.2	P2.3	P3.1	P3.2	P3.3	P4.1	P4.2	P4.3	M1.1	M1.2
■	■	■	■	■	■	■	■	■	■	■	■	■	■
M2.1	K1.1	K1.2	K1.3	K2.1	K2.2	K2.3	K3.1	K3.2	N1.1	N1.2	N1.3	N2.1	N2.2
■	■	■	■	■	■	■	■	■	■	■	■	■	■
N2.3	N3.1	N3.2	N3.3	N4.1	N4.2								
■	■	■	■	■	■								

DCON MS tolerance h11; DC <= 2.5mm Straight flute, form A.

Product	nom d	DC_1	DC_2	OAL	LCF	NOF	WSC	DCON MS
		(mm)	(mm)	(mm)	(mm)		(mm)	(mm)
B9521.2	1.2	1.10	1.74	50.0	32.0	3	2.40	3.15
B9521.5	1.5	1.40	2.14	57.0	37.0	3	2.40	3.15
B9522.0	2.0	1.90	2.86	68.0	48.0	3	2.40	3.15
B9522.5	2.5	2.40	3.36	68.0	48.0	4	2.40	3.15
B9523.0	3.0	2.90	4.06	80.0	58.0	5	3.00	4.00
B9523.5	3.5	3.40	4.66	87.0	63.0	5	3.40	4.50
B9524.0	4.0	3.90	5.26	93.0	68.0	5	3.80	5.00
B9524.5	4.5	4.40	5.80	95.0	70.0	5	4.30	5.60
B9525.0	5.0	4.90	6.36	100.0	73.0	5	4.90	6.30
B9525.5	5.5	5.40	7.20	118.0	90.0	6	5.50	7.10
B9526.0	6.0	5.90	8.00	135.0	105.0	6	6.20	8.00
B9526.5	6.5	6.40	8.60	140.0	110.0	6	6.20	8.00
B9527.0	7.0	6.90	9.40	160.0	125.0	6	7.00	9.00
B9528.0	8.0	7.90	10.80	180.0	145.0	6	8.00	10.00
B9529.0	9.0	8.90	12.10	195.0	160.0	6	9.00	11.20
B95210.0	10.0	9.90	13.40	215.0	175.0	6	10.00	12.50
B95212.0	12.0	11.80	16.00	255.0	210.0	8	11.00	14.00
B95213.0	13.0	12.80	17.00	255.0	210.0	8	12.00	16.00
B95214.0	14.0	13.80	18.00	255.0	210.0	8	12.00	16.00
B95216.0	16.0	15.80	20.40	280.0	230.0	8	14.50	18.00
B95220.0	20.0	19.80	24.80	310.0	250.0	8	18.00	22.40
B95225.0	25.0	24.70	30.70	370.0	300.0	10	22.00	28.00
B95230.0	30.0	29.70	36.10	400.0	320.0	10	24.00	31.50
B95240.0	40.0	39.70	46.50	430.0	340.0	12	32.00	40.00
B95250.0	50.0	49.70	56.90	460.0	360.0	12	39.00	50.00

B122



HSS Reduced Shank Hand Car Reamer, Steam and Bronze Tempered Finish

Designed to re-align holes in thin walled sheets of steel, prior to bolting or riveting them together. It is designed to be used by hand. The small Pilot diameter makes it easy to locate and align the tool into pre-drilled holes. Suitable in many materials.

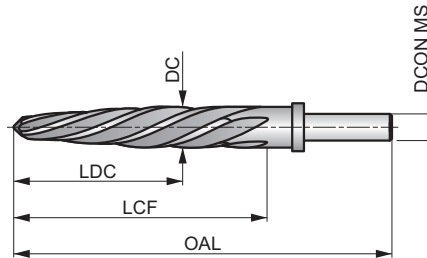

HSS	ST Bronze	ANSI
R		

Workpiece material group suitability, starting values for cutting speed (m/min) and feed Alpha Code. Tables with feed per revolution can be found starting from page 123.

P1.1 ■ 15 C	P1.2 ■ 16 C	P1.3 ■ 17 C	P2.1 ■ 13 C	P2.2 ■ 11 C	P3.1 ■ 7 B	M1.1 ■ 11 C	M1.2 ■ 10 B	M2.1 ■ 9 B	N1.1 ■ 23 F	N1.2 ■ 17 F	N2.1 ■ 23 E	N2.2 ■ 21 E	N3.1 ■ 34 D
N3.2 ■ 20 E	N4.1 ■ 22 B	N4.2 ■ 21 B											

Product	DC (inch)	DC (inch)	OAL (inch)	LCF (inch)	NOF	DCONMS (inch)
B1223/8	3/8	0.3750	4.5/8	2.1/2	4	3/8
B1221/2	1/2	0.5000	5.7/8	3.3/4	5	1/2
B1229/16	9/16	0.5625	5.7/8	3.3/4	5	1/2
B1225/8	5/8	0.6250	6.3/8	4.1/4	5	1/2
B12211/16	11/16	0.6875	6.3/8	4.1/4	5	1/2
B1223/4	3/4	0.7500	6.7/8	4.1/2	5	1/2
B12213/16	13/16	0.8125	6.7/8	4.1/2	5	1/2
B1227/8	7/8	0.8750	6.7/8	4.1/2	5	1/2
B12215/16	15/16	0.9375	6.7/8	4.1/2	5	1/2
B1221	1"	1.0000	6.7/8	4.1/2	5	1/2
B1221.1/16	1.1/16	1.0625	6.7/8	4.1/2	5	1/2

B121



HSS Taper Shank Machine Bridge Reamer

Designed to re-align holes in large fabrications, where two or more workpieces are joined, before bolting or riveting them. The small Pilot diameter from the 1 to 10 ratio taper lead simplifies the need to locate and align the tool in pre-drilled holes. Suitable for reaming in many materials.

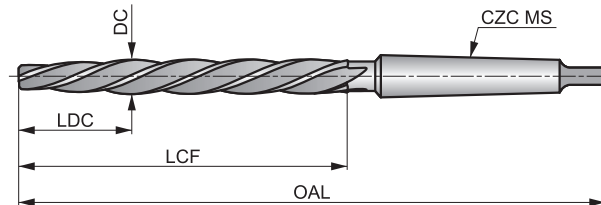

HSS	Bright ST	DIN 311
R		k11

Workpiece material group suitability, starting values for cutting speed (m/min) and feed Alpha Code. Tables with feed per revolution can be found starting from page 123.

P1.1 ■ 15 C	P1.2 ■ 16 C	P1.3 ■ 17 C	P2.1 ■ 13 C	P2.2 ■ 11 C	P2.3 ▣ 10 B	P3.1 ■ 7 B	P3.2 ■ 6 B	P3.3 ▣ 5 B	P4.1 ■ 4 B	P4.2 ▣ 4 B	P4.3 ▣ 3 A	K1.1 ■ 14 E	K1.2 ■ 10 D
K1.3 ▣ 8 D	K2.1 ■ 12 C	K2.2 ■ 10 C	K2.3 ▣ 8 C	K3.1 ▣ 11 C	K3.2 ▣ 8 C	N1.1 ▣ 23 F	N1.2 ■ 17 F	N1.3 ■ 9 F	N2.1 ▣ 21 E	N2.2 ■ 18 E	N2.3 ▣ 14 E	N3.1 ■ 34 D	N3.2 ■ 20 E
N3.3 ▣ 10 D	N4.1 ▣ 21 B												

With 1:10 starting taper (LDC).

Product	DC (mm)	OAL (mm)	LCF (mm)	LDC (mm)	NOF	CZC MS
B12110.0	10.00	171.0	95.0	30.00	4	MK 1
B12111.0	11.00	176.0	100.0	33.00	4	MK 1
B12112.0	12.00	199.0	105.0	39.00	4	MK 2
B12113.0	13.00	199.0	105.0	39.00	4	MK 2
B12114.0	14.00	209.0	115.0	42.00	4	MK 2
B12115.0	15.00	219.0	125.0	45.00	4	MK 2
B12116.0	16.00	229.0	135.0	48.00	4	MK 2
B12117.0	17.00	251.0	135.0	51.00	4	MK 3
B12118.0	18.00	261.0	145.0	58.00	4	MK 3
B12119.0	19.00	261.0	145.0	58.00	4	MK 3
B12120.0	20.00	271.0	155.0	62.00	4	MK 3
B12121.0	21.00	271.0	155.0	62.00	4	MK 3
B12122.0	22.00	281.0	165.0	66.00	4	MK 3
B12123.0	23.00	281.0	165.0	66.00	4	MK 3
B12124.0	24.00	296.0	180.0	72.00	4	MK 3
B12125.0	25.00	296.0	180.0	72.00	4	MK 3
B12126.0	26.00	296.0	180.0	72.00	4	MK 3
B12130.0	30.00	311.0	195.0	78.00	5	MK 3



B101

HSS-E Taper Shank Machine Reamer with H7 Accuracy

Taper Shank machine reamer according to BS 328. The precision ground left-hand helix and right-hand cutting action, ensures smooth reaming and improved surface finish and hole size. Suitable for reaming in many materials.

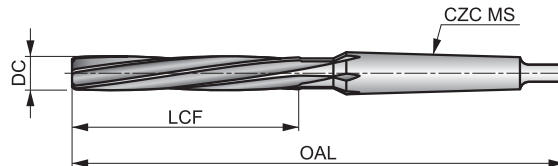

HSS-E	Bright ST	BS 328
R		B
H7		

Workpiece material group suitability, starting values for cutting speed (m/min) and feed Alpha Code. Tables with feed per revolution can be found starting from page 123.

P1.1 ■ 15 C	P1.2 ■ 16 C	P1.3 ■ 17 C	P2.1 ■ 13 C	P2.2 ■ 11 C	P2.3 ▣ 10 B	P3.1 ■ 7 B	P3.2 ■ 6 B	P3.3 ▣ 5 B	P4.1 ■ 4 B	P4.2 ▣ 4 B	P4.3 ▣ 3 A	M1.1 ▣ 7 B	M1.2 ▣ 6 A
K1.1 ■ 14 E	K1.2 ■ 10 D	K1.3 ▣ 8 D	K2.1 ■ 12 C	K2.2 ■ 10 C	K2.3 ▣ 8 C	K3.1 ■ 11 C	K3.2 ▣ 8 C	N1.1 ▣ 23 F	N1.2 ■ 17 F	N1.3 ■ 9 F	N2.1 ▣ 25 E	N2.2 ■ 18 E	N2.3 ■ 14 E
N3.1 ■ 34 D	N3.2 ■ 20 E	N3.3 ▣ 10 D	N4.1 ▣ 22 B										

Product	DC (inch)	DC (mm)	OAL (mm)	LCF (mm)	NOF	CZC MS
B1013.0	—	3.00	112.0	33.0	4	MK 1
B1011/8	1/8	3.18	112.0	33.0	4	MK 1
B1013.5	—	3.50	115.0	35.0	6	MK 1
B1014.0	—	4.00	117.0	38.0	6	MK 1
B1014.5	—	4.50	120.0	41.0	6	MK 1
B1013/16	3/16	4.76	124.0	44.0	6	MK 1
B1015.0	—	5.00	124.0	44.0	6	MK 1
B1015.5	—	5.50	127.0	47.0	6	MK 1
B1016.0	—	6.00	127.0	47.0	6	MK 1
B1011/4	1/4	6.35	130.0	50.0	6	MK 1
B1016.5	—	6.50	130.0	50.0	6	MK 1
B1017.0	—	7.00	134.0	54.0	6	MK 1
B1015/16	5/16	7.94	138.0	58.0	6	MK 1
B1018.0	—	8.00	138.0	58.0	6	MK 1
B1018.5	—	8.50	138.0	58.0	6	MK 1
B1019.0	—	9.00	142.0	62.0	6	MK 1
B1019.5	—	9.50	142.0	62.0	6	MK 1
B1013/8	3/8	9.52	146.0	66.0	6	MK 1
B10110.0	—	10.00	146.0	66.0	6	MK 1
B10110.5	—	10.50	146.0	66.0	6	MK 1
B10111.0	—	11.00	151.0	71.0	6	MK 1
B1017/16	7/16	11.11	151.0	71.0	6	MK 1
B10112.0	—	12.00	156.0	76.0	6	MK 1
B10112.5	—	12.50	156.0	76.0	6	MK 1
B1011/2	1/2	12.70	156.0	76.0	6	MK 1
B10113.0	—	13.00	156.0	76.0	6	MK 1
B10113.5	—	13.50	161.0	81.0	6	MK 1
B10114.0	—	14.00	161.0	81.0	8	MK 1

Product	DC (inch)	DC (mm)	OAL (mm)	LCF (mm)	NOF	CZC MS
B1019/16	9/16	14.29	181.0	81.0	8	MK 2
B10114.5	—	14.50	181.0	81.0	8	MK 2
B10115.0	—	15.00	181.0	81.0	8	MK 2
B10115.5	—	15.50	187.0	87.0	8	MK 2
B1015/8	5/8	15.88	187.0	87.0	8	MK 2
B10116.0	—	16.00	187.0	87.0	8	MK 2
B10116.5	—	16.50	187.0	87.0	8	MK 2
B10117.0	—	17.00	187.0	87.0	8	MK 2
B10118.0	—	18.00	193.0	93.0	8	MK 2
B10119.0	—	19.00	193.0	93.0	8	MK 2
B1013/4	3/4	19.05	200.0	100.0	8	MK 2
B10120.0	—	20.00	200.0	100.0	8	MK 2
B10113/16	13/16	20.64	200.0	100.0	8	MK 2
B10121.0	—	21.00	200.0	100.0	8	MK 2
B10122.0	—	22.00	207.0	107.0	8	MK 2
B1017/8	7/8	22.22	207.0	107.0	8	MK 2
B10123.0	—	23.00	207.0	107.0	8	MK 2
B10124.0	—	24.00	242.0	115.0	8	MK 3
B10125.0	—	25.00	242.0	115.0	10	MK 3
B1011	1"	25.40	242.0	115.0	10	MK 3
B10126.0	—	26.00	242.0	115.0	10	MK 3
B10127.0	—	27.00	251.0	124.0	10	MK 3
B10128.0	—	28.00	251.0	124.0	10	MK 3
B1011.1/8	1.1/8	28.58	251.0	124.0	10	MK 3
B10129.0	—	29.00	251.0	124.0	10	MK 3
B10130.0	—	30.00	251.0	124.0	10	MK 3
B10131.0	—	31.00	260.0	133.0	10	MK 3
B1011.1/4	1.1/4	31.75	260.0	133.0	10	MK 3



Product	DC	DC	OAL	LCF	NOF	CZC MS
	(inch)	(mm)	(mm)	(mm)		
B10132.0	–	32.00	293.0	133.0	10	MK 4
B10134.0	–	34.00	302.0	142.0	10	MK 4
B1011.3/8	1.3/8	34.93	302.0	142.0	10	MK 4
B10135.0	–	35.00	302.0	142.0	10	MK 4
B10136.0	–	36.00	302.0	142.0	10	MK 4
B10137.0	–	37.00	302.0	142.0	10	MK 4
B10138.0	–	38.00	312.0	152.0	10	MK 4
B1011.1/2	1.1/2	38.10	312.0	152.0	10	MK 4
B10139.0	–	39.00	312.0	152.0	10	MK 4
B10140.0	–	40.00	312.0	152.0	10	MK 4
B10141.0	–	41.00	312.0	152.0	10	MK 4

Product	DC	DC	OAL	LCF	NOF	CZC MS
	(inch)	(mm)	(mm)	(mm)		
B10142.0	–	42.00	312.0	152.0	10	MK 4
B10143.0	–	43.00	323.0	163.0	10	MK 4
B10144.0	–	44.00	323.0	163.0	10	MK 4
B1011.3/4	1.3/4	44.45	323.0	163.0	10	MK 4
B10145.0	–	45.00	323.0	163.0	12	MK 4
B10146.0	–	46.00	323.0	163.0	12	MK 4
B10147.0	–	47.00	323.0	163.0	12	MK 4
B10148.0	–	48.00	334.0	174.0	12	MK 4
B10150.0	–	50.00	334.0	174.0	12	MK 4
B1012	2"	50.80	334.0	174.0	12	MK 4

B161

HSS-E Taper Shank Machine Reamer with H7 Accuracy, Bright Finish

The precision ground left-hand helix and right-hand cutting action, ensures smooth reaming and improved surface finish and hole size. Suitable for reaming in many materials.

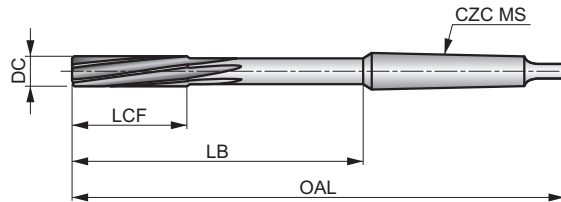

HSS-E	Bright	DIN 208
R		B
H7		

Workpiece material group suitability, starting values for cutting speed (m/min) and feed Alpha Code. Tables with feed per revolution can be found starting from page 123.

P1.1 ■ 21 C	P1.2 ■ 24 C	P1.3 ■ 25 C	P2.1 ■ 18 C	P2.2 ■ 16 C	P2.3 ▣ 14 B	P3.1 ■ 13 B	P3.2 ■ 11 B	P3.3 ▣ 9 B	P4.1 ■ 8 B	P4.2 ▣ 7 B	P4.3 ▣ 5 A	M1.1 ▣ 11 C	M1.2 ▣ 10 B
M2.1 ▣ 9 B	K1.1 ■ 16 E	K1.2 ■ 12 D	K1.3 ▣ 9 D	K2.1 ■ 16 C	K2.2 ■ 13 C	K2.3 ▣ 10 C	K3.1 ■ 14 C	K3.2 ▣ 11 C	N1.1 ▣ 24 F	N1.2 ■ 18 F	N1.3 ■ 11 F	N2.1 ▣ 27 E	N2.2 ■ 24 E
N2.3 ■ 16 E	N3.1 ■ 47 D	N3.2 ■ 28 E	N3.3 ▣ 14 D	N4.1 ▣ 30 B									

Product	DC (mm)	OAL (mm)	LCF (mm)	LB (mm)	NOF	CZC MS
B1613.0	3.00	113.0	15.0	47.50	6	MK 1
B1614.0	4.00	124.0	19.0	58.50	6	MK 1
B1615.0	5.00	133.0	23.0	67.50	6	MK 1
B1616.0	6.00	138.0	26.0	72.50	6	MK 1
B1617.0	7.00	150.0	31.0	84.50	6	MK 1
B1618.0	8.00	156.0	33.0	90.50	6	MK 1
B1619.0	9.00	162.0	36.0	96.50	6	MK 1
B16110.0	10.00	168.0	38.0	102.50	6	MK 1
B16111.0	11.00	175.0	41.0	109.50	6	MK 1
B16112.0	12.00	182.0	44.0	116.50	6	MK 1
B16113.0	13.00	182.0	44.0	116.50	6	MK 1
B16114.0	14.00	189.0	47.0	123.50	8	MK 1
B16115.0	15.00	204.0	50.0	124.00	8	MK 2
B16116.0	16.00	210.0	52.0	130.00	8	MK 2
B16117.0	17.00	214.0	54.0	134.00	8	MK 2
B16118.0	18.00	219.0	56.0	139.00	8	MK 2
B16119.0	19.00	223.0	58.0	143.00	8	MK 2
B16120.0	20.00	228.0	60.0	148.00	8	MK 2
B16121.0	21.00	232.0	62.0	152.00	8	MK 2
B16122.0	22.00	237.0	64.0	157.00	8	MK 2
B16123.0	23.00	241.0	66.0	161.00	8	MK 2
B16124.0	24.00	268.0	68.0	169.00	8	MK 3

Product	DC (mm)	OAL (mm)	LCF (mm)	LB (mm)	NOF	CZC MS
B16125.0	25.00	268.0	68.0	169.00	8	MK 3
B16126.0	26.00	273.0	70.0	174.00	8	MK 3
B16127.0	27.00	277.0	71.0	178.00	10	MK 3
B16128.0	28.00	277.0	71.0	178.00	10	MK 3
B16129.0	29.00	281.0	73.0	182.00	10	MK 3
B16130.0	30.00	281.0	73.0	182.00	10	MK 3
B16131.0	31.00	285.0	75.0	186.00	10	MK 3
B16132.0	32.00	317.0	77.0	193.00	10	MK 4
B16133.0	33.00	317.0	77.0	193.00	10	MK 4
B16134.0	34.00	321.0	78.0	197.00	10	MK 4
B16135.0	35.00	321.0	78.0	197.00	10	MK 4
B16136.0	36.00	325.0	79.0	201.00	10	MK 4
B16138.0	38.00	329.0	81.0	205.00	10	MK 4
B16140.0	40.00	329.0	81.0	205.00	10	MK 4
B16142.0	42.00	333.0	82.0	209.00	12	MK 4
B16144.0	44.00	336.0	83.0	212.00	12	MK 4
B16145.0	45.00	336.0	83.0	212.00	12	MK 4
B16146.0	46.00	340.0	84.0	216.00	12	MK 4
B16147.0	47.00	340.0	84.0	216.00	12	MK 4
B16148.0	48.00	344.0	86.0	220.00	12	MK 4
B16150.0	50.00	344.0	86.0	220.00	12	MK 4

B955



HSS-E Shell Reamer with H7 Accuracy, Bright and Steam Tempered

Shell reamers to be used with an arbor that fits the hole in the reamer. They are precision ground with a left-hand helix and right-hand cutting to provide smooth reaming. With a 45° bevel lead for accurate location and centering in the hole to improve performance and hole quality. Suitable for reaming in many materials.

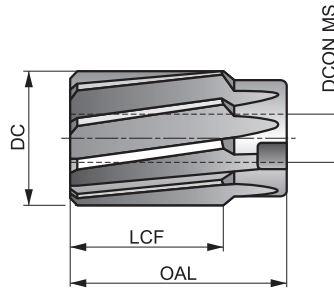

HSS-E	Bright ST	DIN 219
R	B	H7

Workpiece material group suitability, starting values for cutting speed (m/min) and feed Alpha Code. Tables with feed per revolution can be found starting from page 123.

P1.1 ■ 15 C	P1.2 ■ 16 C	P1.3 ■ 17 C	P2.1 ■ 13 C	P2.2 ■ 11 C	P2.3 ▧ 10 B	P3.1 ■ 7 B	P3.2 ■ 6 B	P3.3 ▧ 5 B	P4.1 ■ 4 B	P4.2 ▧ 4 B	P4.3 ▧ 3 A	M1.1 ▧ 11 C	M1.2 ▧ 10 B
M2.1 ▧ 9 B	K1.1 ■ 10 E	K1.2 ■ 8 D	K1.3 ▧ 7 D	K2.1 ■ 10 C	K2.2 ■ 9 C	K2.3 ▧ 6 C	K3.1 ▧ 10 C	K3.2 ▧ 7 C	N1.1 ▧ 17 F	N1.2 ■ 17 F	N1.3 ■ 10 F	N2.1 ▧ 23 E	N2.2 ■ 21 E
N2.3 ■ 13 E	N3.1 ■ 34 D	N3.2 ■ 20 E	N3.3 ▧ 10 D	N4.1 ▧ 24 C									

Product	DC (mm)	OAL (mm)	LCF (mm)	NOF	DCON MS (mm)
B95525.0	25.00	45.0	32.0	8	13.00
B95526.0	26.00	45.0	32.0	8	13.00
B95527.0	27.00	45.0	32.0	8	13.00
B95528.0	28.00	45.0	32.0	8	13.00
B95529.0	29.00	45.0	32.0	8	13.00
B95530.0	30.00	45.0	32.0	8	13.00
B95531.0	31.00	50.0	36.0	10	16.00
B95532.0	32.00	50.0	36.0	10	16.00
B95534.0	34.00	50.0	36.0	10	16.00
B95535.0	35.00	50.0	36.0	10	16.00
B95536.0	36.00	56.0	40.0	10	19.00
B95537.0	37.00	56.0	40.0	10	19.00
B95538.0	38.00	56.0	40.0	10	19.00
B95540.0	40.00	56.0	40.0	10	19.00

Product	DC (mm)	OAL (mm)	LCF (mm)	NOF	DCON MS (mm)
B95542.0	42.00	56.0	40.0	10	19.00
B95544.0	44.00	63.0	45.0	12	22.00
B95545.0	45.00	63.0	45.0	12	22.00
B95548.0	48.00	63.0	45.0	12	22.00
B95550.0	50.00	63.0	45.0	12	22.00
B95552.0	52.00	71.0	50.0	12	27.00
B95555.0	55.00	71.0	50.0	12	27.00
B95558.0	58.00	71.0	50.0	12	27.00
B95560.0	60.00	71.0	50.0	12	27.00
B95565.0	65.00	80.0	56.0	14	32.00
B95570.0	70.00	80.0	56.0	14	32.00
B95575.0	75.00	90.0	63.0	14	40.00
B95580.0	80.00	90.0	63.0	14	40.00

B956



Shell Reamer Arbor for B955

Arbor used to hold shell reamers in machine applications. It has a taper shank to be held directly in the machine spindle. For arbor spare parts (drivers, nuts and washers) please see Dormer's B957 range for availability.

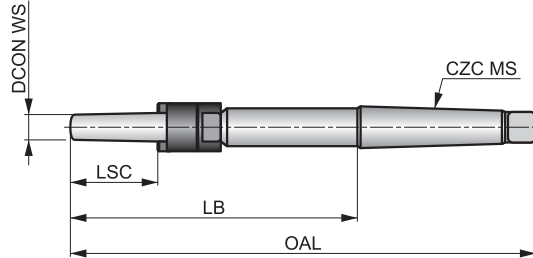

HSS-E	Bright	DIN 217

Product	DCON WS (mm)	OAL (mm)	LSC (mm)	LB (mm)	CZC MS
B95613.0	13.00	250.0	45	151.00	MK 3
B95616.0	16.00	261.0	50	162.00	MK 3
B95619.0	19.00	298.0	56	174.00	MK 4
B95622.0	22.00	312.0	63	188.00	MK 4
B95627.0	27.00	359.0	71	203.00	MK 5
B95632.0	32.00	376.0	80	220.00	MK 5
B95640.0	40.00	396.0	90	240.00	MK 5

B957



Spare Parts for B956 Arbors

The B957 range of spare parts for B956 arbors consist of drivers, nuts and washers. They can be purchased individually by size, ensuring continued use safely and securely. The B957 drivers, nuts and washers are manufactured to required standards.

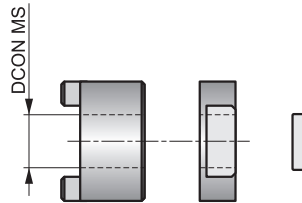

Product	Nr.	DCON MS
		(mm)
B957N3DRIVER	3	13.00
B957N3NUT	3	–
B957N3WASHER	3	–
B957N4DRIVER	4	16.00
B957N4NUT	4	–
B957N4WASHER	4	–
B957N5DRIVER	5	19.00
B957N5NUT	5	–
B957N5WASHER	5	–
B957N6DRIVER	6	22.00
B957N6NUT	6	–
B957N6WASHER	6	–
B957N7DRIVER	7	27.00
B957N7NUT	7	–
B957N7WASHER	7	–
B957N8DRIVER	8	32.00
B957N8NUT	8	–
B957N8WASHER	8	–
B957N9DRIVER	9	40.00
B957N9NUT	9	–
B957N9WASHER	9	–

G136



HSS Straight Shank 90° Countersink, Bright Finish

A 90° Countersink designed to chamfer holes and for removing burrs from drilled holes. Reduced shank allows larger diameter countersinks in standard holders and chucks. Versatile tool, which can be used in hand-held and machine applications. Suitable to chamfer holes in many materials.

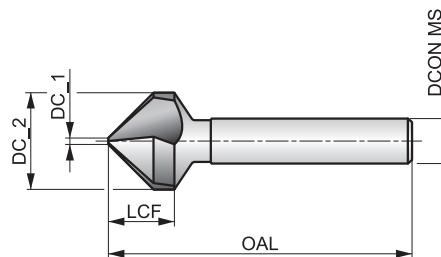

HSS	Bright	DIN 335C
R	90°	

Workpiece material group suitability, starting values for cutting speed (m/min) and feed Alpha Code. Tables with feed per revolution can be found starting from page 123.

P1.1 ■ 23 E	P1.2 ■ 26 E	P1.3 ■ 27 E	P2.1 ■ 20 E	P2.2 ■ 18 D	P2.3 ▣ 16 B	P3.1 ■ 16 D	P3.2 ■ 13 D	P3.3 ▣ 11 B	P4.1 ■ 10 D	P4.2 ▣ 8 B	M1.1 ▣ 8 C	M1.2 ▣ 6 C	M2.1 ▣ 7 C
M2.2 ▣ 6 C	K1.1 ▣ 20 F	K1.2 ▣ 15 D	K2.1 ▣ 21 C	K2.2 ▣ 17 C	K3.1 ▣ 18 C	K3.2 ▣ 14 C	K5.1 ▣ 19 C	K5.2 ▣ 15 C	N1.1 ▣ 40 G	N1.2 ■ 30 G	N1.3 ▣ 20 F	N2.1 ■ 20 F	N2.2 ▣ 18 F
N3.1 ■ 21 F	N3.2 ■ 12 F	N3.3 ▣ 6 D	N4.1 ▣ 40 G	N4.2 ▣ 35 G									

DCON MS tolerance h9.

Products from this series are also available in set. Please see G236.

Product	DC_2	DC_1	LCF	OAL	DCON MS	NOF
	(mm)	(mm)	(mm)	(mm)	(mm)	
G1364.3	4.30	1.30	4.0	40.0	4.00	3
G1365.0	5.00	1.50	4.5	40.0	4.00	3
G1365.3	5.30	1.50	4.5	40.0	4.00	3
G1365.8	5.80	1.50	5.0	45.0	5.00	3
G1366.0	6.00	1.50	5.0	45.0	5.00	3
G1366.3	6.30	1.50	5.5	45.0	5.00	3
G1367.0	7.00	1.80	5.5	50.0	6.00	3
G1367.3	7.30	1.80	6.1	50.0	6.00	3
G1368.0	8.00	2.00	6.1	50.0	6.00	3
G1368.3	8.30	2.00	6.5	50.0	6.00	3
G1369.4	9.40	2.20	7.2	50.0	6.00	3
G13610.0	10.00	2.50	7.6	50.0	6.00	3
G13610.4	10.40	2.50	7.6	50.0	6.00	3

Product	DC_2	DC_1	LCF	OAL	DCON MS	NOF
	(mm)	(mm)	(mm)	(mm)	(mm)	
G13611.5	11.50	2.80	8.0	56.0	8.00	3
G13612.4	12.40	2.80	8.5	56.0	8.00	3
G13613.4	13.40	2.90	9.0	56.0	8.00	3
G13615.0	15.00	3.20	9.5	60.0	10.00	3
G13616.5	16.50	3.20	10.5	60.0	10.00	3
G13619.0	19.00	3.50	11.7	63.0	10.00	3
G13620.5	20.50	3.50	13.0	63.0	10.00	3
G13623.0	23.00	3.80	13.7	67.0	10.00	3
G13625.0	25.00	3.80	15.5	67.0	10.00	3
G13626.0	26.00	3.80	15.5	67.0	10.00	3
G13628.0	28.00	4.00	16.5	71.0	12.00	3
G13630.0	30.00	4.20	18.5	71.0	12.00	3
G13631.0	31.00	4.20	18.5	71.0	12.00	3

G142



HSS Straight Shank, 90° Countersink, Bright Finish, for Stainless Steel

A 90° Countersink designed for chamfering holes for standard fasteners and to clean burrs from drilled holes. Increased relief to provide a sharper edge, which improves performance when machining sticky materials, such as stainless steels and non-ferrous materials. Can be used in handheld and machine applications.

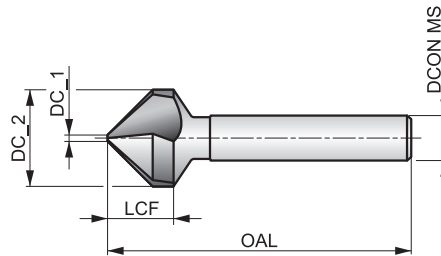

HSS	Bright	DIN 335C
R	90°	

Workpiece material group suitability, starting values for cutting speed (m/min) and feed Alpha Code. Tables with feed per revolution can be found starting from page 123.

P1.1 ■ 23 E	P1.2 ■ 26 E	P1.3 ■ 27 E	P2.1 ■ 20 E	P2.2 ■ 18 D	P2.3 ▧ 16 B	P3.1 ■ 16 D	P3.2 ■ 13 D	P3.3 ▧ 11 B	P4.1 ■ 10 D	P4.2 ▧ 8 B	M1.1 ■ 11 C	M1.2 ■ 9 C	M2.1 ■ 10 C
M2.2 ▧ 8 C	M3.1 ■ 7 B	M3.2 ▧ 6 B	M4.1 ▧ 4 A	N1.1 ■ 40 G	N1.2 ■ 30 G	N1.3 ▧ 20 F	N2.1 ▧ 20 F	N2.2 ▧ 18 F	N2.3 ▧ 20 F	N3.1 ■ 34 F	N3.2 ■ 20 F	N3.3 ■ 10 D	N4.1 ■ 40 G
N4.2 ■ 35 G													

DCON MS tolerance h9.

Product	DC_2 (mm)	DC_1 (mm)	LCF (mm)	OAL (mm)	DCON MS (mm)	NOF
G1424.8	4.80	1.30	4.5	40.0	4.00	3
G1425.0	5.00	1.50	4.5	40.0	4.00	3
G1426.0	6.00	1.50	5.0	45.0	5.00	3
G1426.3	6.30	1.50	5.5	45.0	5.00	3
G1427.0	7.00	1.80	5.5	50.0	6.00	3
G1427.3	7.30	1.80	6.1	50.0	6.00	3
G1428.0	8.00	2.00	6.1	50.0	6.00	3
G1428.3	8.30	2.00	6.5	50.0	6.00	3
G14210.0	10.00	2.50	7.6	50.0	6.00	3
G14210.4	10.40	2.50	7.6	50.0	6.00	3
G14211.5	11.50	2.80	8.0	56.0	8.00	3
G14212.4	12.40	2.80	8.5	56.0	8.00	3
G14215.0	15.00	3.20	9.5	60.0	10.00	3
G14216.5	16.50	3.20	10.5	60.0	10.00	3
G14219.0	19.00	3.50	11.7	63.0	10.00	3
G14220.5	20.50	3.50	13.0	63.0	10.00	3
G14223.0	23.00	3.80	13.7	67.0	10.00	3
G14225.0	25.00	3.80	15.5	67.0	10.00	3
G14231.0	31.00	4.20	18.5	71.0	12.00	3

G106



HSS Tri-Flat Straight Shank 90° Countersink, Bright Finish

A 90° Countersink designed for chamfering standard fastener holes and removing burrs from drilled holes. Shank with three ground flats gives improved holding in three jaw chucks. Suitable to chamfer holes in many materials.

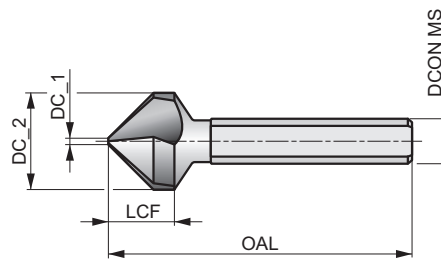

HSS	Bright	DIN 335C
R	90°	

Workpiece material group suitability, starting values for cutting speed (m/min) and feed Alpha Code. Tables with feed per revolution can be found starting from page 123.

P1.1 ■ 23 E	P1.2 ■ 26 E	P1.3 ■ 27 E	P2.1 ■ 20 E	P2.2 ■ 18 D	P2.3 ▧ 16 B	P3.1 ■ 16 D	P3.2 ■ 13 D	P3.3 ▧ 11 B	P4.1 ■ 10 D	P4.2 ▧ 8 B	M1.1 ▧ 8 C	M1.2 ▧ 6 C	M2.1 ▧ 7 C
M2.2 ▧ 16 C	K1.1 ■ 20 F	K1.2 ■ 15 D	K2.1 ▧ 21 C	K2.2 ▧ 17 C	K3.1 ▧ 18 C	K3.2 ▧ 14 C	K5.1 ▧ 19 C	K5.2 ▧ 15 C	N1.1 ▧ 40 G	N1.2 ■ 30 G	N1.3 ▧ 20 F	N2.1 ▧ 20 F	N2.2 ▧ 18 F
N3.1 ■ 21 F	N3.2 ▧ 12 F	N3.3 ▧ 6 D	N4.1 ▧ 40 G	N4.2 ▧ 35 G									

DCON MS tolerance h9.

Products from this series are also available in set. Please see G236.

Product	DC_2 (mm)	DC_1 (mm)	LCF (mm)	OAL (mm)	DCON MS (mm)	NOF
G1066.3	6.30	1.50	5.6	45.0	5.00	3
G1068.3	8.30	2.00	6.9	50.0	6.00	3
G10610.4	10.40	2.50	7.8	50.0	6.00	3
G10612.4	12.40	2.80	8.6	56.0	8.00	3
G10616.5	16.50	3.20	11.1	60.0	10.00	3
G10620.5	20.50	3.50	12.9	63.0	10.00	3
G10625.0	25.00	3.80	15.7	67.0	10.00	3
G10631.0	31.00	4.20	18.5	71.0	12.00	3
G10634.0	34.00	4.50	19.0	103.0	16.00	3
G10637.0	37.00	4.50	21.2	118.0	16.00	3
G10640.0	40.00	4.50	20.0	118.0	16.00	3
G10650.0	50.00	5.00	23.6	126.0	16.00	3

G107



HSS-E Hexagon Drive 90° Countersink, Bright Finish

A versatile countersink with a hexagonal shank which makes it easier to hold with electric screwdriver adaptors. The 90° countersink produces chamfers for standard fasteners and clean burrs from drilled holes. Suitable to chamfer holes in many materials.

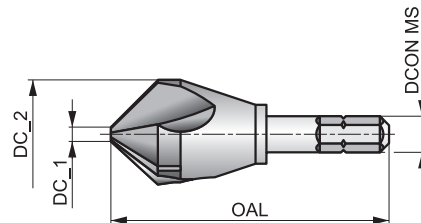

HSS-E	Bright	DORMER
R	90°	

Workpiece material group suitability, starting values for cutting speed (m/min) and feed Alpha Code. Tables with feed per revolution can be found starting from page 123.

P1.1 ■ 23 E	P1.2 ■ 26 E	P1.3 ■ 27 E	P2.1 ■ 20 E	P2.2 ■ 18 D	P2.3 ▧ 16 B	P3.1 ■ 16 D	P3.2 ■ 13 D	P3.3 ▧ 11 B	P4.1 ■ 10 D	P4.2 ▧ 8 B	M1.1 ▧ 11 C	M1.2 ▧ 9 C	M2.1 ▧ 10 C
M2.2 ▧ 9 C	M2.3 ▧ 8 B	K1.1 ■ 20 F	K1.2 ▧ 15 D	K2.1 ■ 21 C	K2.2 ▧ 17 C	K3.1 ■ 18 C	K3.2 ▧ 14 C	K4.1 ▧ 15 C	K5.1 ■ 19 C	K5.2 ▧ 15 C	N1.1 ▧ 40 G	N1.2 ■ 30 G	N1.3 ▧ 20 F
N2.1 ▧ 20 F	N2.2 ▧ 18 F	N2.3 ▧ 20 F	N3.1 ■ 21 F	N3.2 ▧ 12 F	N3.3 ▧ 6 D	N4.1 ▧ 40 G	N4.2 ▧ 35 G						

6.35; 1/4" hex shank; DIN 74.

Product	DC_2	DC_1	OAL	DCONMS	CZC MS	NOF
	(mm)	(mm)	(mm)	(inch)		
G1076.3	6.30	1.50	50.0	1/4"	M2-M3	3
G1078.3	8.30	2.00	50.0	1/4"	M4	3
G10710.4	10.40	2.50	50.0	1/4"	M5	3
G10712.4	12.40	2.80	50.0	1/4"	M6	3
G10716.5	16.50	3.20	50.0	1/4"	M8	3
G10720.5	20.50	3.50	50.0	1/4"	M10	3

G600



HSS Straight Shank Long Reach 90° Countersink, Bright Finish

The extended shank gives the ability to chamfer holes in areas which are difficult to reach. The 90° countersink produces chamfers for standard fasteners and clean burrs from drilled holes. Suitable to chamfer holes in many materials.

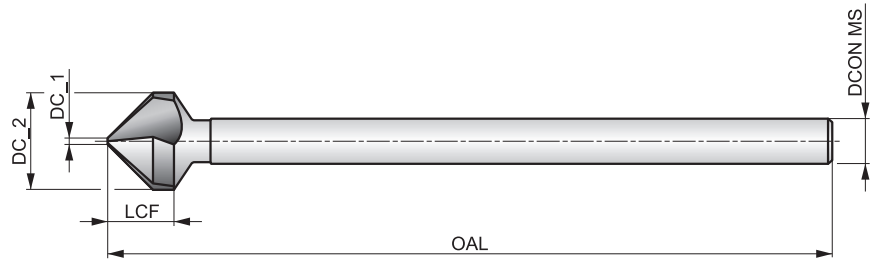

HSS	Bright	DORMER
R	90°	

Workpiece material group suitability, starting values for cutting speed (m/min) and feed Alpha Code. Tables with feed per revolution can be found starting from page 123.

P1.1 ■ 20 E	P1.2 ■ 22 E	P1.3 ■ 23 E	P2.1 ■ 17 E	P2.2 ■ 15 D	P2.3 ■ 13 B	P3.1 ■ 12 D	P3.2 ■ 9 D	P3.3 ■ 8 B	P4.1 ■ 7 D	P4.2 ■ 6 B	M1.1 ■ 8 C	M1.2 ■ 6 C	M2.1 ■ 7 C
M2.2 ■ 16 C	K1.1 ■ 17 E	K1.2 ■ 12 C	K2.1 ■ 18 B	K2.2 ■ 14 B	K3.1 ■ 15 B	K3.2 ■ 11 B	K5.1 ■ 16 B	K5.2 ■ 12 B	N1.1 ■ 35 G	N1.2 ■ 25 G	N1.3 ■ 15 F	N2.1 ■ 15 F	N2.2 ■ 13 F
N3.1 ■ 16 E	N3.2 ■ 10 E	N3.3 ■ 5 C											

DCON MS tolerance h9.

Product	DC_2 (mm)	DC_1 (mm)	LCF (mm)	OAL (mm)	DCON MS (mm)	NOF
G6006.3	6.30	1.30	5.6	154.0	5.00	3
G6008.3	8.30	1.80	6.9	155.0	6.00	3
G60010.4	10.40	2.20	7.8	157.0	6.00	3
G60012.4	12.40	2.50	8.6	158.0	8.00	3
G60015.0	15.00	2.80	10.3	159.0	10.00	3
G60016.5	16.50	2.80	11.1	161.0	10.00	3
G60020.5	20.50	3.00	12.9	164.0	10.00	3
G60025.0	25.00	3.20	15.7	168.0	10.00	3



G560



HSS Straight Shank 90° Countersink, TiAIN Coated

A 90° Countersink designed for chamfering standard fastener holes and removing burrs from drilled holes. Reduced shank allows larger diameter countersinks in standard holders and chucks. Versatile tool, which can be used in hand-held and machine applications. TiAIN coating improves performance and extends tool life.

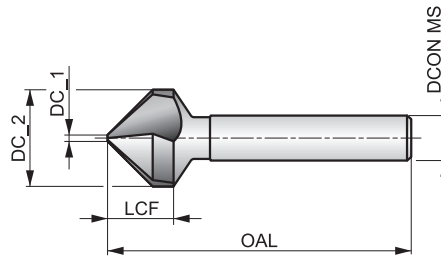

HSS	TiAIN	DIN 335C
R	90°	

Workpiece material group suitability, starting values for cutting speed (m/min) and feed Alpha Code. Tables with feed per revolution can be found starting from page 123.

P1.1 ■ 40 E	P1.2 ■ 45 E	P1.3 ■ 46 E	P2.1 ■ 34 E	P2.2 ■ 30 D	P2.3 ■ 27 B	P3.1 ■ 28 D	P3.2 ■ 22 D	P3.3 ■ 19 B	P4.1 ■ 16 D	P4.2 ■ 14 B	P4.3 ▣ 11 B	M1.1 ▣ 11 C	M1.2 ▣ 9 C
M2.1 ▣ 10 C	M2.2 ▣ 9 C	M2.3 ▣ 8 B	K1.1 ■ 41 F	K1.2 ■ 30 D	K1.3 ▣ 23 D	K2.1 ■ 42 C	K2.2 ■ 34 C	K2.3 ▣ 27 C	K3.1 ■ 37 C	K3.2 ■ 28 C	K3.3 ▣ 23 C	K4.1 ▣ 34 C	K4.2 ▣ 26 C
K4.3 ▣ 19 C	K5.1 ■ 39 C	K5.2 ■ 29 C	K5.3 ▣ 23 C	N1.1 ▣ 60 G	N1.2 ▣ 45 G	N1.3 ■ 30 F	N2.1 ■ 30 F	N2.2 ■ 27 F	N2.3 ■ 19 F	N3.1 ■ 32 F	N3.2 ■ 18 F	N3.3 ▣ 9 D	N4.1 ▣ 62 G
N4.2 ▣ 55 G													

DCON MS tolerance h9.

Products from this series are also available in set. Please see G236.

Product	DC_2	DC_1	LCF	OAL	DCON MS	NOF
	(mm)	(mm)	(mm)	(mm)	(mm)	
G5606.3	6.30	1.50	5.5	45.0	5.00	3
G5608.0	8.00	2.00	6.1	50.0	6.00	3
G5608.3	8.30	2.00	6.5	50.0	6.00	3
G56010.0	10.00	2.50	7.6	50.0	6.00	3
G56010.4	10.40	2.50	7.6	50.0	6.00	3
G56012.4	12.40	2.80	8.5	56.0	8.00	3
G56016.5	16.50	3.20	10.5	60.0	10.00	3
G56020.5	20.50	3.50	13.0	63.0	10.00	3
G56025.0	25.00	3.80	15.5	67.0	10.00	3
G56031.0	31.00	4.20	18.5	71.0	12.00	3

G570



HSS-E Straight Shank 90° Countersink, AlTiCN Coated

A 90° Countersink designed for chamfering holes to accommodate standard fasteners and clean burrs from drilled holes. Can be used in machine and hand-held applications. Particularly suited to chamfering holes in hard and abrasive materials. AlTiCN coating improves performance and extends tool life.

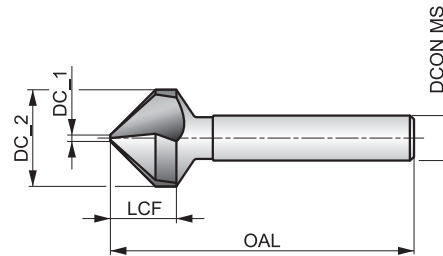

HSS-E	AlTiCN	DIN 335C
R	90°	

Workpiece material group suitability, starting values for cutting speed (m/min) and feed Alpha Code. Tables with feed per revolution can be found starting from page 123.

P1.1 ▣ 40 E	P1.2 ▣ 45 E	P1.3 ▣ 46 E	P2.1 ▣ 34 E	P2.2 ▣ 30 D	P2.3 ▣ 27 B	P3.1 ▣ 28 D	P3.2 ▣ 22 D	P3.3 ▣ 19 B	P4.1 ▣ 16 D	P4.2 ▣ 14 B	P4.3 ▣ 11 B	M1.1 ▣ 23 C	M1.2 ▣ 20 C
M2.1 ▣ 21 C	M2.2 ▣ 17 C	M2.3 ▣ 14 A	M3.1 ▣ 14 B	M3.2 ▣ 12 B	M3.3 ▣ 11 B	M4.1 ▣ 15 A	M4.2 ▣ 13 A	K1.1 ▣ 41 C	K1.2 ▣ 30 C	K1.3 ▣ 23 C	K2.1 ▣ 42 C	K2.2 ▣ 34 C	K2.3 ▣ 27 C
K3.1 ▣ 37 C	K3.2 ▣ 28 C	K3.3 ▣ 23 C	K4.1 ▣ 34 C	K4.2 ▣ 26 C	K4.3 ▣ 19 C	K5.1 ▣ 39 C	K5.2 ▣ 29 C	K5.3 ▣ 23 C	N1.1 ▣ 60 G	N1.2 ▣ 45 G	N1.3 ▣ 30 F	N2.1 ▣ 30 F	N2.2 ▣ 27 F
N2.3 ▣ 19 F	N3.1 ▣ 32 F	N3.2 ▣ 18 F	N3.3 ▣ 9 D										

DCON MS tolerance h9.

Product	DC_2 (mm)	DC_1 (mm)	LCF (mm)	OAL (mm)	DCON MS (mm)	NOF
G5706.3	6.30	1.50	6.5	45.0	5.00	3
G5708.3	8.30	2.00	8.2	50.0	6.00	3
G57010.4	10.40	2.50	9.7	50.0	6.00	3
G57012.4	12.40	2.80	10.6	56.0	8.00	3
G57016.5	16.50	3.20	13.9	60.0	10.00	3
G57020.5	20.50	3.50	17.1	63.0	10.00	3
G57025.0	25.00	3.80	21.4	67.0	10.00	3
G57031.0	31.00	4.20	24.4	71.0	12.00	3

G506



HSS Tri-Flat Straight Shank 90° Countersink, TiAlN Coated

A 90° Countersink designed for chamfering standard fastener holes and removing burrs from drilled holes. Shank with three ground flats gives improved holding in three jaw chucks, especially when using in hand-held power tools. TiAlN coating extends tool life. Suitable to chamfer holes in many materials.

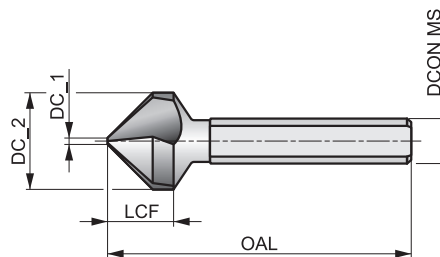

HSS	TiAlN	DIN 335C
R	90°	

Workpiece material group suitability, starting values for cutting speed (m/min) and feed Alpha Code. Tables with feed per revolution can be found starting from page 123.

P1.1 ■ 40 E	P1.2 ■ 45 E	P1.3 ■ 46 E	P2.1 ■ 34 E	P2.2 ■ 30 D	P2.3 ■ 27 B	P3.1 ■ 28 D	P3.2 ■ 22 D	P3.3 ■ 19 B	P4.1 ■ 16 D	P4.2 ■ 14 B	P4.3 ▣ 11 B	M1.1 ▣ 11 C	M1.2 ▣ 9 C
M2.1 ▣ 10 C	M2.2 ▣ 9 C	M2.3 ▣ 8 B	K1.1 ■ 41 F	K1.2 ■ 30 D	K1.3 ▣ 23 D	K2.1 ■ 42 C	K2.2 ■ 34 C	K2.3 ▣ 27 C	K3.1 ■ 37 C	K3.2 ■ 28 C	K3.3 ▣ 23 C	K4.1 ▣ 34 C	K4.2 ▣ 26 C
K4.3 ▣ 19 C	K5.1 ■ 39 C	K5.2 ■ 29 C	K5.3 ▣ 23 C	N1.1 ▣ 60 G	N1.2 ▣ 45 G	N1.3 ■ 30 F	N2.1 ■ 30 F	N2.2 ■ 27 F	N2.3 ■ 19 F	N3.1 ■ 32 F	N3.2 ■ 18 F	N3.3 ▣ 9 D	N4.1 ▣ 62 G
N4.2 ▣ 55 G													

DCON MS tolerance h9.

Products from this series are also available in set. Please see G236.

Product	DC_2 (mm)	DC_1 (mm)	LCF (mm)	OAL (mm)	DCON MS (mm)	NOF
G5066.3	6.30	1.50	5.6	45.0	5.00	3
G5068.3	8.30	2.00	6.9	50.0	6.00	3
G50610.4	10.40	2.50	7.8	50.0	6.00	3
G50612.4	12.40	2.80	8.6	56.0	8.00	3
G50616.5	16.50	3.20	11.1	60.0	10.00	3
G50620.5	20.50	3.50	12.9	63.0	10.00	3
G50625.0	25.00	3.80	15.7	67.0	10.00	3
G50631.0	31.00	4.20	18.5	71.0	12.00	3
G50634.0	34.00	4.50	19.0	103.0	16.00	3
G50637.0	37.00	4.50	21.2	118.0	16.00	3
G50640.0	40.00	4.50	20.0	118.0	16.00	3
G50650.0	50.00	5.00	23.6	126.0	16.00	3

G129



HSS Straight Shank Single Flute 90° Countersink, Bright Finish

A 90° Countersink with bright finish to chamfer and for removing burrs from drilled holes. The single-flute design reduces vibration and chatter for a smooth chamfering operation. Suitable to chamfer holes in mild steels and medium strength non-ferrous materials, such as aluminium.

DC = 6 mm

DC = 8 mm

DC ≥ 10 mm

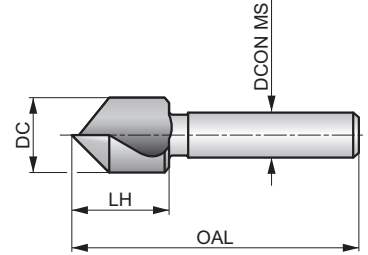
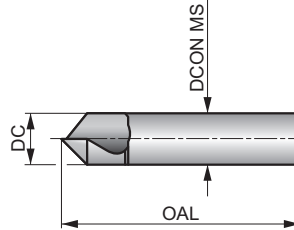
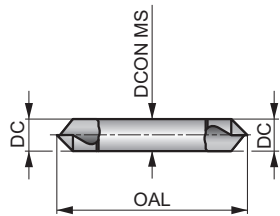

HSS	Bright	DORMER
R	90°	

Workpiece material group suitability, starting values for cutting speed (m/min) and feed Alpha Code. Tables with feed per revolution can be found starting from page 123.

P1.1 ■ 21 D	P1.2 ■ 24 D	P1.3 ■ 25 D	P2.1 ■ 18 D	P2.2 ■ 16 C	P2.3 ▧ 14 A	P3.1 ■ 13 B	P3.2 ▧ 11 B	M1.1 ▧ 8 B	M1.2 ▧ 6 B	M2.1 ▧ 7 B	K1.1 ▧ 18 D	K1.2 ▧ 13 C	K2.1 ▧ 19 A
K2.2 ▧ 15 A	K3.1 ▧ 16 A	K3.2 ▧ 12 A	N1.1 ■ 34 D	N1.2 ■ 25 D	N1.3 ▧ 16 C	N2.1 ▧ 16 C	N2.2 ▧ 14 C	N3.1 ■ 17 C	N3.2 ■ 9 C	N3.3 ▧ 5 B	N4.1 ▧ 35 D	N4.2 ▧ 30 D	

DCON MS tolerance h9.

Product	DC (mm)	LH (mm)	OAL (mm)	DCON MS (mm)	NOF
G1296.0	6.00	–	45.0	6.00	1
G1298.0	8.00	–	50.0	8.00	1
G12910.0	10.00	17.0	49.0	8.00	1
G12912.5	12.50	17.0	49.0	8.00	1
G12916.0	16.00	20.0	56.0	10.00	1
G12920.0	20.00	24.0	60.0	10.00	1
G12925.0	25.00	25.0	75.0	12.00	1
G12931.5	31.50	29.0	80.0	12.00	1

G149



HSS-E Straight Shank Cross-Hole 90° Countersink, Bright Finish

A 90° Countersink designed to chamfer holes and for removing burrs from drilled holes. The special cross-hole design directs chips away from the cutting edge to give a smooth chamfering operation. Suitable to chamfer holes in many materials.

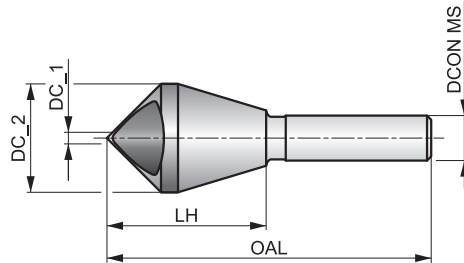

HSS-E	Bright	DORMER
R	90°	

Workpiece material group suitability, starting values for cutting speed (m/min) and feed Alpha Code. Tables with feed per revolution can be found starting from page 123.

P1.1 ▣21 D	P1.2 ▣24 D	P1.3 ▣25 D	P2.1 ▣18 D	P2.2 ▣16 C	P2.3 ▣14 A	P3.1 ▣16 B	P3.2 ▣13 B	M1.1 ▣8 B	M1.2 ▣6 B	M2.1 ▣7 B	K1.1 ▣18 D	K2.1 ▣19 A	K3.1 ▣16 A
K5.1 ▣14 A	N1.1 ▣34 D	N1.2 ▣25 D	N1.3 ▣16 C	N2.1 ▣16 C	N2.2 ▣14 C	N3.1 ▣17 C	N3.2 ▣9 C	N3.3 ▣5 B	N4.1 ▣17 D	N4.2 ▣5 D			

Product	DC_2 (mm)	DC_1 (mm)	LH (mm)	OAL (mm)	DCON MS (mm)	DC (mm)	NOF
G1495	5.00	2.00	19.0	45.0	6.00	10.00	1
G14910	10.00	5.00	23.0	48.0	8.00	14.00	1
G14915	15.00	10.00	34.0	65.0	10.00	21.00	1
G14920	20.00	15.00	43.0	84.0	12.00	28.00	1
G14925	25.00	20.00	48.0	102.0	15.00	35.00	1
G14930	30.00	25.00	61.0	115.0	15.00	44.00	1
G14935	35.00	30.00	65.0	127.0	15.00	48.00	1
G14940	40.00	35.00	66.0	136.0	15.00	53.00	1
G14950	50.00	40.00	85.0	166.0	20.00	60.00	1

G132



HSS Straight Shank Multi-Flute 90° Countersink, Bright Finish

A 90° Countersink designed for chamfering holes to accommodate standard fasteners and clean burrs from drilled holes. Multiple flutes to reduce chatter and vibration, giving a smooth chamfering operation. Versatile tool for use in hand-held and machine applications. Suitable to chamfer holes in many materials.

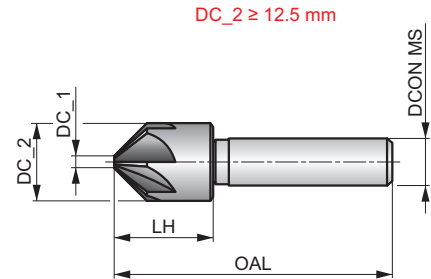
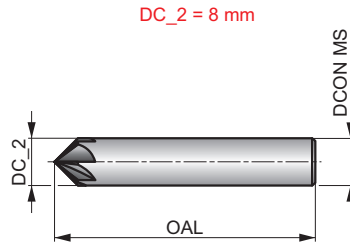

HSS	Bright	DIN 335A
R	90°	

Workpiece material group suitability, starting values for cutting speed (m/min) and feed Alpha Code. Tables with feed per revolution can be found starting from page 123.

P2.2 ▣ 18 E	P2.3 ▣ 16 D	P3.2 ▣ 13 D	P3.3 ▣ 11 B	P4.1 ▣ 10 D	P4.2 ▣ 8 C	P4.3 ▣ 7 B	M3.3 ▣ 3 A	M4.1 ▣ 4 A	K1.1 ▣ 20 F	K1.2 ▣ 15 D	K1.3 ▣ 11 D	K2.2 ▣ 17 C	K2.3 ▣ 14 D
K3.1 ▣ 18 E	K3.2 ▣ 14 E	K3.3 ▣ 11 D	K4.1 ▣ 17 C	K4.2 ▣ 13 C	K5.1 ▣ 19	K5.2 ▣ 15	K5.3 ▣ 11 D	N1.3 ▣ 20 F	N2.3 ▣ 13 F	N3.2 ▣ 12 F	N4.3 ▣ 5 G		

DCON MS tolerance h9.

Product	DC_2 (mm)	DC_1 (mm)	LH (mm)	OAL (mm)	DCON MS (mm)	NOF
G1328.0	8.00	—	—	48.0	8.00	5
G13212.5	12.50	2.00	15.5	48.0	8.00	5
G13216.0	16.00	3.20	19.5	56.0	10.00	7
G13220.0	20.00	5.00	23.0	60.0	10.00	7

G135



HSS Straight Shank 60° Countersink, Bright Finish

With a 60° angle to chamfer holes for special fasteners and removing burrs from drilled holes in diameters up to 25.0 mm. For use in both machine and hand-held operations. Suitable to chamfer holes in many materials.

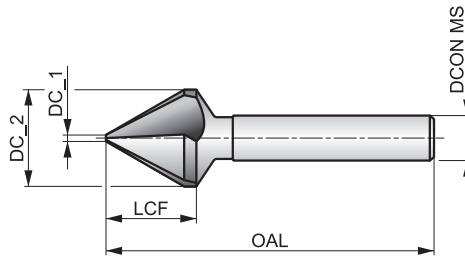

HSS	Bright	DIN 334C
R	60°	

Workpiece material group suitability, starting values for cutting speed (m/min) and feed Alpha Code. Tables with feed per revolution can be found starting from page 123.

P1.1 ■ 23 E	P1.2 ■ 26 E	P1.3 ■ 27 E	P2.1 ■ 20 E	P2.2 ■ 18 D	P2.3 ▧ 16 B	P3.1 ■ 16 D	P3.2 ▧ 13 D	P3.3 ▧ 11 B	P4.1 ■ 10 D	P4.2 ▧ 8 B	M1.1 ▧ 8 C	M1.2 ▧ 6 C	M2.1 ▧ 7 C
M2.2 ▧ 6 C	K1.1 ▧ 20 F	K1.2 ▧ 15 D	K2.1 ▧ 21 C	K2.2 ▧ 17 C	K3.1 ▧ 18 C	K3.2 ▧ 14 C	K5.1 ▧ 19 C	K5.2 ▧ 15 C	N1.1 ▧ 40 G	N1.2 ■ 30 G	N1.3 ▧ 20 F	N2.1 ■ 20 F	N2.2 ▧ 18 F
N3.1 ■ 21 F	N3.2 ■ 12 F	N3.3 ▧ 6 D	N4.1 ▧ 40 G	N4.2 ▧ 35 G									

DCON MS tolerance h9.

Product	DC_2 (mm)	DC_1 (mm)	LCF (mm)	OAL (mm)	DCON MS (mm)	NOF
G1356.3	6.30	1.60	6.8	45.0	5.00	3
G1358.0	8.00	2.00	8.5	50.0	6.00	3
G13510.0	10.00	2.50	7.6	50.0	6.00	3
G13512.5	12.50	3.20	11.7	56.0	8.00	3
G13516.0	16.00	4.00	14.5	63.0	10.00	3
G13520.0	20.00	5.00	17.5	67.0	10.00	3
G13525.0	25.00	6.30	20.5	71.0	10.00	3

G154



HSS Straight Shank 82° Countersink, Bright Finish

An 82° Countersink for flat head cap screws and to chamfer holes. Versatile tool that can be used in both hand-held and machine applications. Suitable to chamfer holes in many materials.

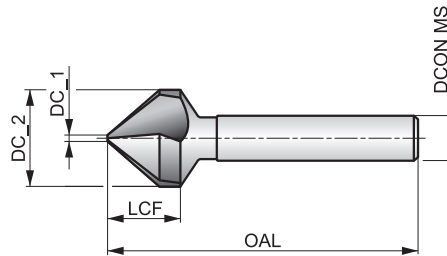

HSS	Bright	DIN 335C
R	82°	

Workpiece material group suitability, starting values for cutting speed (m/min) and feed Alpha Code. Tables with feed per revolution can be found starting from page 123.

P1.1 ■ 23 E	P1.2 ■ 26 E	P1.3 ■ 27 E	P2.1 ■ 20 E	P2.2 ■ 18 D	P2.3 ▧ 16 B	P3.1 ■ 16 D	P3.2 ■ 13 D	P3.3 ▧ 11 B	P4.1 ■ 10 D	P4.2 ▧ 8 B	M1.1 ▧ 8 C	M1.2 ▧ 6 C	M2.1 ▧ 7 C
M2.2 ▧ 6 C	K1.1 ▧ 20 F	K1.2 ▧ 15 D	K2.1 ▧ 21 C	K2.2 ▧ 17 C	K3.1 ▧ 18 C	K3.2 ▧ 14 C	K5.1 ▧ 14 C	K5.2 ▧ 10 C	N1.1 ▧ 40 G	N1.2 ■ 30 G	N1.3 ▧ 20 F	N2.1 ■ 20 F	N2.2 ▧ 18 F
N3.1 ■ 21 F	N3.2 ■ 12 F	N3.3 ▧ 6 D	N4.1 ▧ 40 G	N4.2 ▧ 35 G									

DCON MS tolerance h9.

Product	DC_2 (mm)	DC_1 (mm)	LCF (mm)	OAL (mm)	DCON MS (mm)	NOF
G1546.3	6.30	1.50	5.5	45.0	5.00	3
G1548.3	8.30	2.00	6.5	50.0	6.00	3
G15410.4	10.40	2.50	7.6	50.0	6.00	3
G15412.4	12.40	2.80	8.5	56.0	8.00	3
G15416.5	16.50	3.20	10.5	60.0	10.00	3
G15420.5	20.50	3.50	13.0	63.0	10.00	3
G15425.0	25.00	3.80	15.5	67.0	10.00	3

G171



HSS Straight Shank 100° Countersink, TiAIN Coated

A 100° Countersink designed for chamfering standard fastener holes and removing burrs. A versatile tool with a TiAIN coating which improves performance and extends tool life. Versatile tool that can be used in both hand-held and machine applications. Suitable to chamfer holes in many materials.

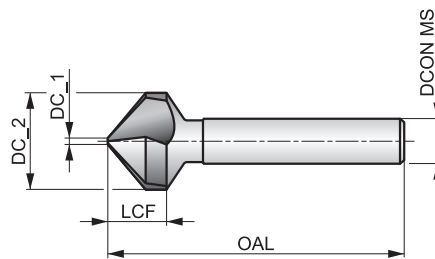

HSS	TiAIN	DIN 335C
R	100°	

Workpiece material group suitability, starting values for cutting speed (m/min) and feed Alpha Code. Tables with feed per revolution can be found starting from page 123.

P1.1 ■ 40 E	P1.2 ■ 45 E	P1.3 ■ 46 E	P2.1 ■ 34 E	P2.2 ■ 30 D	P2.3 ■ 27 B	P3.1 ■ 28 D	P3.2 ■ 22 D	P3.3 ■ 19 B	P4.1 ■ 16 D	P4.2 ■ 14 B	P4.3 ▧ 11 B	M1.1 ▧ 11 C	M1.2 ▧ 9 C
M2.1 ▧ 10 C	K1.1 ■ 41 F	K1.2 ■ 30 D	K1.3 ▧ 23 D	K2.1 ■ 42 C	K2.2 ■ 34 C	K2.3 ▧ 27 C	K3.1 ■ 37 C	K3.2 ■ 28 C	K3.3 ▧ 23 C	K4.1 ▧ 34 C	K4.2 ▧ 26 C	K4.3 ▧ 19 C	K5.1 ■ 39 C
K5.2 ■ 29 C	K5.3 ▧ 23 C	N1.1 ▧ 60 G	N1.2 ▧ 45 G	N1.3 ■ 30 F	N2.1 ■ 30 F	N2.2 ■ 27 F	N2.3 ■ 19 F	N3.1 ■ 32 F	N3.2 ■ 18 F	N3.3 ▧ 9 D	N4.1 ▧ 62 G	N4.2 ▧ 55 G	

DCON MS tolerance h9.

Product	DC_2 (mm)	DC_1 (mm)	LCF (mm)	OAL (mm)	DCON MS (mm)	NOF
G1716.3	6.30	1.50	4.5	44.0	5.00	3
G1718.3	8.30	2.00	5.5	49.0	6.00	3
G17110.4	10.40	2.50	6.6	49.0	6.00	3
G17112.4	12.40	2.80	7.0	53.0	8.00	3
G17116.5	16.50	3.20	9.0	56.0	10.00	3
G17120.5	20.50	3.50	11.0	61.0	10.00	3
G17125.0	25.00	3.80	13.5	65.0	10.00	3

G138



HSS Taper Shank 90° Countersink, Bright Finish

A 90° Countersink designed for chamfering standard fastener holes and removing burrs from drilled holes. Taper shank design allows the tool to be used in machine applications where it is held directly in the spindle. Suitable to chamfer holes in many materials.

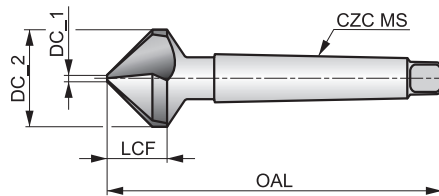

HSS	Bright	DIN 335D
R	90°	

Workpiece material group suitability, starting values for cutting speed (m/min) and feed Alpha Code. Tables with feed per revolution can be found starting from page 123.

P1.1 ■ 23 E	P1.2 ■ 26 E	P1.3 ■ 27 E	P2.1 ■ 20 E	P2.2 ■ 18 D	P2.3 ▧ 16 B	P3.1 ■ 16 D	P3.2 ▧ 13 D	P3.3 ▧ 11 B	P4.1 ■ 10 D	P4.2 ▧ 8 B	M1.1 ▧ 8	M1.2 ▧ 6	M2.1 ▧ 7
M2.2 ▧ 6	K1.1 ▧ 20 F	K1.2 ▧ 15 D	K2.1 ▧ 21 C	K2.2 ▧ 17 C	K3.1 ▧ 18 C	K3.2 ▧ 14 C	K5.1 ▧ 19 C	K5.2 ▧ 15 C	N1.1 ▧ 40 G	N1.2 ■ 30 G	N1.3 ▧ 20 F	N2.1 ■ 20 F	N2.2 ▧ 18 F
N3.1 ■ 21 F	N3.2 ■ 12 F	N3.3 ▧ 6 D	N4.1 ▧ 40 G	N4.2 ▧ 35 G									

Product	DC_2 (mm)	DC_1 (mm)	LCF (mm)	OAL (mm)	CZC MS	NOF
G13825.0	25.00	3.80	15.5	106.0	MK 2	3
G13830.0	30.00	4.20	18.5	112.0	MK 2	3
G13831.0	31.00	4.20	20.0	112.0	MK 2	3
G13834.0	34.00	4.50	19.5	118.0	MK 2	3
G13837.0	37.00	4.80	21.7	118.0	MK 2	3
G13840.0	40.00	10.00	20.5	140.0	MK 3	3
G13850.0	50.00	14.00	24.1	150.0	MK 3	3
G13863.0	63.00	16.00	28.5	180.0	MK 4	3
G13880.0	80.00	22.00	36.0	190.0	MK 4	3

G338

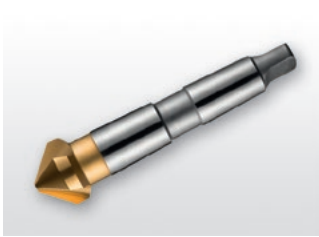

HSS Taper Shank 90° Countersink, TiN Coated

A 90° Countersink designed for chamfering standard fastener holes and removing burrs. Improved performance when machining for long periods at high speed. Taper shank design allows it to be held directly in the spindle. TiN Coating improves performance and extends tool life. Suitable for many materials.

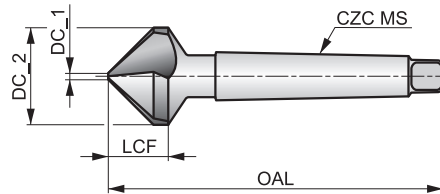

HSS	TiN	DIN 335D
R	90°	

Workpiece material group suitability, starting values for cutting speed (m/min) and feed Alpha Code. Tables with feed per revolution can be found starting from page 123.

P1.1 ■ 33 E	P1.2 ■ 37 E	P1.3 ■ 38 E	P2.1 ■ 28 E	P2.2 ■ 25 D	P2.3 ■ 22 B	P3.1 ■ 23 D	P3.2 ■ 18 D	P3.3 ■ 15 B	P4.1 ■ 13 D	P4.2 ■ 11 B	P4.3 ▧ 9 B	M1.1 ▧ 11 C	M1.2 ▧ 9 C
M2.1 ▧ 10 C	M2.2 ▧ 9 C	M2.3 ▧ 8 B	K1.1 ■ 34 F	K1.2 ■ 25 D	K1.3 ▧ 19 D	K2.1 ■ 35 C	K2.2 ■ 28 C	K2.3 ▧ 23 C	K3.1 ■ 31 C	K3.2 ■ 24 C	K3.3 ▧ 19 C	K4.1 ▧ 29 C	K4.2 ▧ 22 C
K4.3 ▧ 16 C	K5.1 ■ 32 C	K5.2 ■ 24 C	K5.3 ▧ 19 C	N1.1 ■ 53 G	N1.2 ■ 40 G	N1.3 ■ 27 F	N2.1 ■ 27 F	N2.2 ■ 24 F	N2.3 ■ 17 F	N3.1 ■ 28 F	N3.2 ■ 16 F	N3.3 ▧ 8 D	N4.1 ▧ 58 G
N4.2 ▧ 50 G													

Product	DC_2 (mm)	DC_1 (mm)	LCF (mm)	OAL (mm)	CZC MS	NOF
G33825.0	25.00	3.80	15.5	106.0	MK 2	3
G33831.0	31.00	4.20	20.0	112.0	MK 2	3
G33837.0	37.00	4.80	21.7	118.0	MK 2	3
G33840.0	40.00	10.00	20.5	140.0	MK 3	3
G33850.0	50.00	14.00	24.1	150.0	MK 3	3
G33863.0	63.00	16.00	28.5	180.0	MK 4	3

G314



HSS Cone Cut Step Drill for Thin Sheet Materials, Bright Finish

Cone cut step drills have a multi-step design which allows for gradual enlargement of holes to the diameter required. The reduced plain shank means all diameters can be held in a standard chuck and holder. Suitable to enlarge holes in many materials.

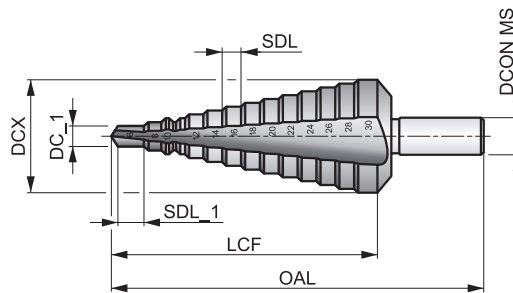

HSS	Bright	DORMER
R	20°	Standard

Workpiece material group suitability.

P1.1 ■ 20	P1.2 ■ 22	P1.3 ■ 23	P2.1 ■ 17	P2.2 ■ 15	P2.3 ■ 13	P3.1 ■ 12	P3.2 ■ 9	M1.1 ■ 8	M1.2 ■ 6	M2.1 ■ 7	K1.1 ■ 17	N1.1 ■ 30	N1.2 ■ 23
N1.3 ■ 15	N2.1 ■ 31	N2.2 ■ 28	N3.1 ■ 34	N3.2 ■ 20	N3.3 ■ 10	N4.1 ■ 30	N4.2 ■ 20						

SDI = Step diameter increments.

Product	Nr.	DC_1 (mm)	DCX (mm)	SDL (mm)	SDI (mm)	SDL_1 (mm)	LCF (mm)	OAL (mm)	DCON MS (mm)
G314412	412	4.00	12.00	5.00	4 - 5 - 6 - 7 - 8 - 9 - 10 - 11 - 12	5.00	61.0	80.0	6.00
G3141220	1220	12.00	20.00	4.00	12 - 13 - 14 - 15 - 16 - 17 - 18 - 19 - 20	4.00	55.0	76.0	9.00
G3142030	2030	20.00	30.00	4.00	20 - 21 - 22 - 23 - 24 - 25 - 26 - 27 - 28 - 29 - 30	4.00	67.0	88.0	12.00
G3143040	3040	30.00	40.00	4.00	30 - 31 - 32 - 33 - 34 - 35 - 36 - 37 - 38 - 39 - 40	4.00	74.0	98.0	13.00
G314420	420	4.00	20.00	4.00	4 - 6 - 8 - 10 - 12 - 14 - 16 - 18 - 20	4.00	48.0	76.0	8.00
G314630	630	6.00	30.00	4.00	6 - 8 - 10 - 12 - 14 - 16 - 18 - 20 - 22 - 24 - 26 - 28 - 30	4.00	73.0	98.0	10.00
G314M	M	9.00	36.00	3.00	9 - 12 - 15 - 18 - 21 - 24 - 27 - 30 - 33 - 36	3.00	57.0	86.0	12.00



G236



Sets of Countersink in a Cylindrical Plastic Drum

Sets containing a variety of sizes of different 90° countersinks. There are 5 different sets filled either with G106, G136 or G560 available. Suitable for many materials.

A=Styles in Set, B=No. in Set, C=Diameters in Set.

Product	Nr.	A	B	C
G2361	1	G136	6	6.30 mm, 8.30 mm, 10.40 mm, 12.40 mm, 16.50 mm, 20.50 mm
G2362	2	G136	4	6.30 mm, 10.40 mm, 16.50 mm, 20.50 mm
G2363	3	G560	6	6.30 mm, 8.30 mm, 10.40 mm, 12.40 mm, 16.50 mm, 20.50 mm
G2364	4	G106	6	6.30 mm, 8.30 mm, 10.40 mm, 12.40 mm, 16.50 mm, 20.50 mm
G2365	5	G506	6	6.30 mm, 8.30 mm, 10.40 mm, 12.40 mm, 16.50 mm, 20.50 mm

REAMERS FEED RATE CHART

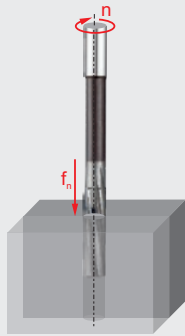

Feed per revolution (f_n in mm/rev)
Depending on the working conditions
it might be necessary to adjust these
values $\pm 15\%$.

How to use this table to find the feed per revolution (f_n):

1. Find your Alpha Code on the product page (example: 21C, "C" is the Alpha Code).
2. Find the closest diameter for your cutting application in the top row of the table.
3. Find your Alpha Code in the left column of the table.
4. The intersection (cell) of the Diameter and Alpha Code is the feed per revolution (f_n).

		\varnothing DC [mm]																		
		1.00	1.50	2.00	3.00	4.00	5.00	6.00	7.00	8.00	10.00	12.00	15.00	16.00	20.00	25.00	30.00	40.00	50.00	80.00
Feed rates	A	0.030	0.045	0.055	0.078	0.090	0.100	0.125	0.137	0.150	0.170	0.185	0.210	0.220	0.250	0.280	0.320	0.390	0.440	0.500
	B	0.035	0.055	0.072	0.110	0.130	0.150	0.165	0.172	0.180	0.210	0.240	0.270	0.280	0.310	0.360	0.400	0.500	0.550	0.600
	C	0.040	0.065	0.085	0.135	0.160	0.185	0.200	0.210	0.220	0.260	0.285	0.325	0.335	0.390	0.440	0.480	0.600	0.680	0.750
	D	0.050	0.080	0.110	0.160	0.180	0.200	0.235	0.253	0.270	0.320	0.360	0.400	0.410	0.470	0.540	0.600	0.730	0.850	0.950
	E	0.065	0.100	0.140	0.180	0.215	0.250	0.300	0.325	0.350	0.390	0.430	0.485	0.500	0.530	0.640	0.750	0.910	1.100	1.200
	F	0.090	0.140	0.180	0.260	0.305	0.350	0.395	0.417	0.440	0.500	0.550	0.610	0.630	0.700	0.800	0.930	1.200	1.500	1.650

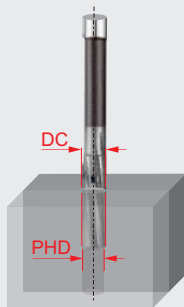

Machining allowance when using
a **machine reamer** (MA in mm)
Premachined hole diameter
 $PHD = DC - MA$.

How to use this table to get to the right premachined hole diameter (PHD):

1. Find the diameter range for your cutting application in the top row of the table.
2. Find your ISO Group Code in the left column of the table (example: For Stainless Steel the ISO Group Code is "M")
3. The intersection (cell) of the Diameter Range and ISO Group Code is the Machining Allowance (MA)
4. Subtract the Machining Allowance from the reaming diameter to get to the premachined hole diameter (PHD).

(example: for a 6mm hole in steel (P) the PHD is 5.85mm)

		\varnothing DC [mm]										
		1.00	5.00	5.00	8.00	8.00	12.00	12.00	16.00	16.00	30.00	30.00
ISO group	P	0.10		0.15		0.20		0.20		0.30		0.30
	M	0.08		0.10		0.10		0.20		0.20		0.30
	K	0.10		0.15		0.20		0.20		0.30		0.30
	N	0.10		0.15		0.20		0.20		0.30		0.30
	S	0.05		0.10		0.10		0.15		0.20		0.20
	H	0.05		0.05		0.10		0.10		0.15		0.20

Be cautious with the machining tolerances of drills, the tool diameter is not the same as the hole diameter produced!

Note: The recommended allowance when using a hand reamer is 0.05 to 0.10 mm.

COUNTERSINKS FEED RATE CHART

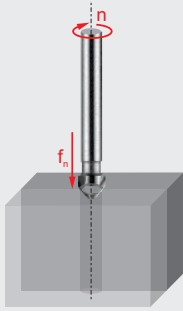

Feed per revolution (f_n in mm/rev)
Depending on the working conditions
it might be necessary to adjust these
values $\pm 15\%$.

How to use this table to find the feed per revolution (f_n):

1. Find your Alpha Code on the product page (example: 23E, "E" is the Alpha Code).
2. Find the closest diameter for your cutting application in the top row of the table.
3. Find your Alpha Code in the left column of the table.
4. The intersection (cell) of the Diameter and Alpha Code is the feed per revolution (f_n).

		$\varnothing DC$ [mm]									
		6.00	8.00	10.00	16.00	20.00	25.00	32.00	40.00	60.00	80.00
Feed rates	A	0.030	0.040	0.050	0.060	0.080	0.090	0.100	0.120	0.140	0.160
	B	0.040	0.050	0.060	0.080	0.100	0.120	0.140	0.160	0.180	0.200
	C	0.050	0.060	0.080	0.100	0.120	0.140	0.160	0.180	0.200	0.220
	D	0.060	0.080	0.100	0.120	0.150	0.180	0.200	0.220	0.250	0.280
	E	0.080	0.100	0.120	0.150	0.180	0.200	0.250	0.270	0.300	0.320
	F	0.090	0.110	0.130	0.160	0.190	0.210	0.260	0.290	0.330	0.360
	G	0.100	0.120	0.150	0.180	0.200	0.220	0.280	0.320	0.360	0.400
	H	0.120	0.150	0.180	0.200	0.220	0.250	0.300	0.350	0.400	0.450

Reamer Definitions / Nomenclature

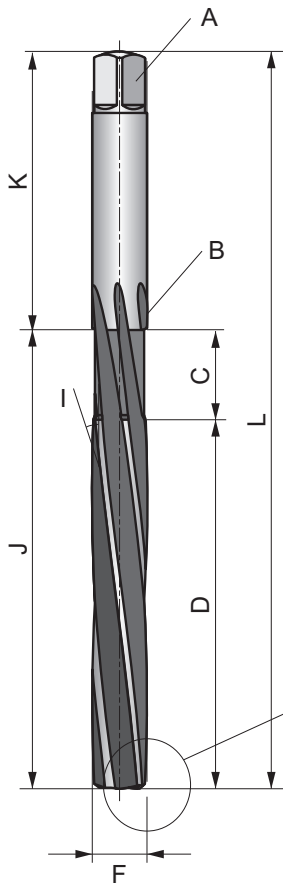

A	Tang or Square Drive
B	Recess Diameter
C	Recess Length
D	Cut Length
E	Bevel Lead Length
F	Diameter

G	Bevel Lead
H	Bevel Lead Angle
I	Helix Angle
J	Body Length
K	Shank Length
L	Overall Length

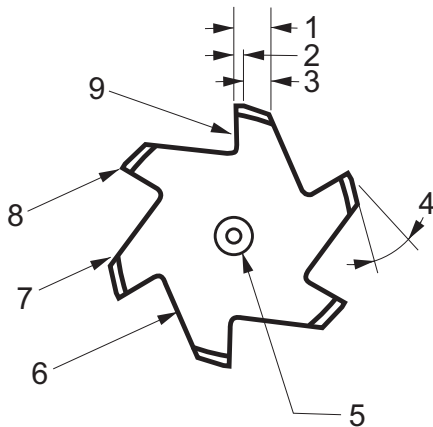
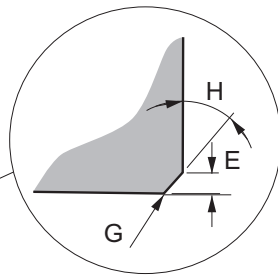

1	Width of Land
2	Circular Land
3	Clearance
4	Clearance Angle
5	Centre Hole
6	Flute
7	Heel
8	Cutting Edge
9	Face

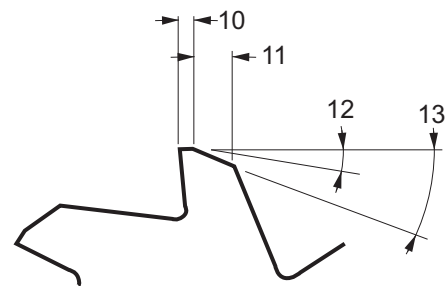

10	Width of Primary Clearance
11	Width of Secondary Clearance
12	Primary Clearance Angle
13	Secondary Clearance Angle

Reaming

To obtain the best results when using reamers it is essential to make them ‘work’. It is a common fault to prepare holes for reaming with too little stock left in the starting hole diameter. If insufficient stock is left in the hole before reaming, the reamer will rub, quickly show wear and will result in loss of diameter. It is equally important for performance not to leave too much stock in the hole. (See Stock removal below).

1. Select the optimum type of reamer and the optimum speeds and feeds for the application. Ensure that pre-drilled holes are the correct diameter.
2. The workpiece must be held rigid and the machine spindle should have no play.
3. The chuck for straight shank reamers must be of good quality and in good working condition. If the reamer slips in the chuck and the feed is automatic, breakage of the reamer may occur.
4. Keep tool overhang from machine spindle to a minimum.

5. Use recommended lubricants to enhance the life of the reamer and ensure the fluid reaches the cutting edges. As reaming is not a heavy cutting operation, soluble oil 40:1 dilution is normally satisfactory. Air blasting may be used with grey cast iron, if dry machining.
6. Do not allow the flutes of a reamer to become blocked with chips. Retract if necessary to empty the flutes, this can help to prevent poor hole quality and breakage of the tool.
7. Before the reamer is reground, check concentricity between centres. In most instances only the bevel lead will need regrinding.
8. Keep reamers sharp. Frequent regrinding is good economy, but it is important to understand that reamers cut only on the bevel and taper leads and not on the lands. Consequently only these leads need regrinding. Accuracy of regrinding is important to hole quality and tool life.

Stock removal

The recommended stock removal in reaming is dependent on the application material and the surface finish of the pre-drilled hole. General guidelines for stock removal are shown in the following tables:

Size of reamed hole [mm]	When pre-drilled	When pre-core-drilled
Below 4	0.1	0.1
Over 4 to 11	0.2	0.15
Over 11 to 39	0.3	0.2
Over 39 to 50	0.4	0.3

Size of reamed hole [inches]	When pre-drilled	When pre-core-drilled
Below 3/16"	0.004"	0.004"
3/16 to 1/2"	0.008"	0.006"
1/2 to 1.1/2"	0.010"	0.008"
1.1/2 to 2"	0.016"	0.010"

Hand/Machine reaming

Although both hand and machine reamers offer the same capability regarding finished hole size, the use of each must be considered according to the application. A hand reamer, for reasons of alignment, has a long taper lead, whereas a machine reamer has only a 45 degree bevel lead. A machine reamer cuts only on the bevel lead while a hand reamer cuts on the bevel lead as well as the taper lead.

REAMING – TOLERANCE LIMITS – TECHNICAL INFO

Tolerance limits



1. On the cutting diameter of standard reamers

The diameter (DC) is measured across the circular land immediately behind the bevel or taper lead. The tolerance is in accordance with DIN 1420 and is intended to produce H7 holes.

Reamer tolerance			
Diameter [mm]		Tolerance Limit [mm]	
Over	Up to and including	High +	Low +
–	3	0.008	0.004
3	6	0.010	0.005
6	10	0.012	0.006
10	18	0.015	0.008

Reamer tolerance			
Diameter [mm]		Tolerance Limit [mm]	
Over	Up to and including	High +	Low +
18	30	0.017	0.009
30	50	0.021	0.012
50	80	0.025	0.014

2. H7 hole tolerance

The most common tolerance on a finished hole is H7 (see table below). For any other tolerance the figure and table below (in Note 3) can be used to calculate the reamers tolerance location and width

Hole tolerance			
Diameter [mm]		Tolerance Limit [mm]	
Over	Up to and including	High +	Low +
–	3	0.010	0
3	6	0.012	0
6	10	0.015	0
10	18	0.018	0

Hole tolerance			
Diameter [mm]		Tolerance Limit [mm]	
Over	Up to and including	High +	Low +
18	30	0.021	0
30	50	0.025	0
50	80	0.030	0

3. Other hole tolerances when it is necessary to define the dimensions of a special reamer intended to cut to a specific tolerance, e.g. D8, this well proven guide can be used.

Diameter tolerance width [µm]								
Tolerance width (microns)	over 1 incl. 3	over 3 incl. 6	over 6 incl. 10	over 10 incl. 18	over 18 incl. 30	over 30 incl. 50	over 50 incl. 80	over 80 incl. 120
IT5	4	5	6	8	9	11	13	15
IT6	6	8	9	11	13	16	19	22
IT7	10	12	15	18	21	25	30	35
IT8	14	18	22	27	33	39	46	54
IT9	25	30	36	43	52	62	74	87
IT10	40	48	58	70	84	100	120	140
IT11	60	75	90	110	130	160	190	220
IT12	100	120	150	180	210	250	300	350

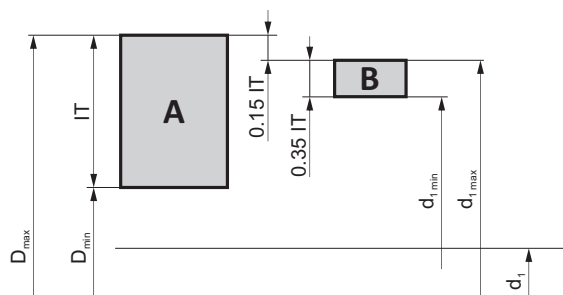

- A** = Hole tolerance
- B** = Reamer tolerance
- IT** = Tolerance width
- D_{max} = Max. diameter of hole
- D_{min} = Min. diameter of hole
- d_1 = Nominal diameter
- d_{1max} = Max. diameter of reamer
- d_{1min} = Min. diameter of reamer

e.g. 10 mm hole with tolerance D8, Max dia = 10.062, Min dia = 10.040, Hole tolerance (IT8) = 0.022

Maximum limit: $0.15 \times \text{hole tolerance (IT8)} = 0.0033$, rounded up = 0.004
 Minimum limit: $0.35 \times \text{hole tolerance (IT8)} = 0.0077$, rounded up = 0.008
 Maximum limit for reamer = $10.062 - 0.004 = 10.058$
 Minimum limit for reamer = $10.058 - 0.008 = 10.050$





REAMING – GENERAL HINTS – TECHNICAL INFO

Trouble shooting when reaming

Problem	Cause	Remedy
Broken or twisted tangs	Incorrect fit between shank and socket	Ensure the shank and socket are clean and free from damage
Rapid tool wear	Insufficient stock to remove	Increase the amount of stock to be removed (smaller hole)
Oversize hole	Excessive lip height variation	Regrind to correct specification
	Displacement in the machine spindle	Repair and rectify spindle displacement
	Defects on the tool holder	Replace tool holder
	Tool shank is damaged	Replace or regrind the shank
	Ovality of the tool	Replace or regrind the tool
	Asymmetric bevel lead angle	Regrind to correct specification
	Too high feed or cutting speed	Adjust cutting conditions in accordance with Catalogue
Undersize hole	Insufficient stock to remove	Increase the amount of stock to be removed (smaller hole)
	Too much heat generated while reaming. The hole widens and shrinks	Increase coolant flow
	The tool diameter is worn and is undersize	Regrind to correct specification or replace tool
	Too low feed or cutting speed	Adjust cutting conditions in accordance with the Catalogue
	Pre-drilled hole is too small	Decrease the amount of stock to be removed (larger hole)
Oval and conical holes	Displacement in the machine spindle	Repair and rectify spindle displacement
	Misalignment between tool and hole	Use a bridge reamer
	Asymmetric bevel lead angle	Regrind to correct specification
Bad hole finish	Excessive stock to remove	Decrease the amount of stock to be removed (larger hole)
	Worn out tool	Regrind to correct specification
	Undersize cutting rake angle	Regrind to correct specification
	Too diluted emulsion or cutting oil	Increase % concentration
	Feed and/or speed too low	Adjust cutting conditions in accordance with Catalogue
	Cutting speed too high	Adjust cutting conditions in accordance with Catalogue
The tool clamps and breaks	Worn out tool	Regrind to correct specification
	Back taper of the tool is too small	Check and replace/modify the tool
	The width of the land is too wide	Check and replace/modify the tool
	Workpiece material tend to squeeze	Use an adjustable reamer to compensate for the displacement
	Pre-drilled hole is too small	Decrease the amount of stock to be removed (larger hole)
	Heterogeneous material with hard inclusions	Use solid carbide reamer

GENERAL – TECHNICAL INFO

	Grade	Hardness (HV10)	C %	W %	Mo %	Cr %	V %	Co %	Tool Material
	M2	810 – 850	0.9	6.4	5.0	4.2	1.8	–	HSS
	M35	830 – 870	0.93	6.4	5.0	4.2	1.8	4.8	HSCO
	M42	870 – 960	1.08	1.5	9.4	3.9	1.2	8.0	



Properties	HSS materials	Carbide materials	K10/30F (often used for solid tools)
Hardness [HV30]	800-950	1300 – 1800	1600
Density [g/cm³]	8.0 – 9.0	7.2 – 15	14.45
Compressive strength [N/mm²]	3000 – 4000	3000 – 8000	6250
Flexural strength, (bending) [N/mm²]	2500 – 4000	1000 – 4700	4300
Heat resistance [°C]	550	1000	900
E-module [KN/mm²]	260 – 300	460 – 630	580
Grain size [µm]	–	0.2 – 10	0.8

The combination of hard particle (WC) and binder metal (Co) give the following changes in characteristics.

Characteristic	Higher WC content give	Higher Co content give
Hardness	Higher hardness	Lower hardness
Compressive strength [CS]	Higher CS	Lower CS
Bending strength [BS]	Lower BS	Higher BS

Grain size also influences the material properties. Small grain sizes means higher hardness and coarse grains give more toughness.

Surface treatment / Coating properties examples

Surface Treatments	Colour	Coating material	Hardness [HV]	Thickness [µm]	Coating structure	Frict. coeff. against steel	Max. appl. temp. [°C]
	Gold	TiN	2300	1-4	Mono-layer	0.4	600
	Black grey	TiAlN	3300	3	Nano structured	0.3-0.35	900



GENERAL – TECHNICAL INFO

Industry Standard tolerances For Shafts & Holes

Tolerance values are shown in Microns (μm)

Formula for Microns ...1 $\mu\text{m} = 0.001 \text{ mm} / 0.000039''$

Tolerance	Diameter [mm]							
	> 1 ≤ 3	> 3 ≤ 6	> 6 ≤ 10	> 10 ≤ 18	> 18 ≤ 30	> 30 ≤ 50	> 50 ≤ 80	> 80 ≤ 120
	Diameter [inch]							
	> 0.039" ≤ 0.118"	> 0.118" ≤ 0.236"	> 0.236" ≤ 0.394"	> 0.394" ≤ 0.709"	> 0.709" ≤ 1.181"	> 1.181" ≤ 1.968"	> 1.968" ≤ 3.149"	> 3.149" ≤ 4.724"
	Tolerance values [μm]							
e8	-14 / -28	-20 / -38	-25 / -47	-32 / -59	-40 / -73	-50 / -89	-60 / -106	-72 / -126
f6	-6 / -12	-10 / -18	-13 / -22	-16 / -27	-20 / -33	-25 / -41	-30 / -49	-36 / -58
f7	-6 / -16	-10 / -22	-13 / -28	-16 / -34	-20 / -41	-25 / -50	-30 / -60	-36 / -71
h6	0 / -6	0 / -8	0 / -9	0 / -11	0 / -13	0 / -16	0 / -19	0 / -22
h7	0 / -10	0 / -12	0 / -15	0 / -18	0 / -21	0 / -25	0 / -30	0 / -35
h8	0 / -14	0 / -18	0 / -22	0 / -27	0 / -33	0 / -39	0 / -46	0 / -54
h9	0 / -25	0 / -30	0 / -36	0 / -43	0 / -52	0 / -62	0 / -74	0 / -87
h10	0 / -40	0 / -48	0 / -58	0 / -70	0 / -84	0 / -100	0 / -120	0 / -140
h11	0 / -60	0 / -75	0 / -90	0 / -110	0 / -130	0 / -160	0 / -190	0 / -220
h12	0 / -100	0 / -120	0 / -150	0 / -180	0 / -210	0 / -250	0 / -300	0 / -350
k10	+40 / 0	+48 / 0	+58 / 0	+70 / 0	+84 / 0	+100 / 0	+120 / 0	+140 / 0
k12	+100 / 0	+120 / 0	+150 / 0	+180 / 0	+210 / 0	+250 / 0	+300 / 0	+350 / 0
m7	+2 / +12	+4 / +16	+6 / +21	+7 / +25	+8 / +29	+9 / +34	+11 / +41	+13 / +48
js14	+ / -125	+ / -150	+ / -180	+ / -215	+ / -260	+ / -310	+ / -370	+ / -435
js16	+ / -300	+ / -375	+ / -450	+ / -550	+ / -650	+ / -800	+ / -950	+ / -1100
H7	+10 / 0	+12 / 0	+15 / 0	+18 / 0	+21 / 0	+25 / 0	+30 / 0	+35 / 0
H8	+14 / 0	+18 / 0	+22 / 0	+27 / 0	+33 / 0	+39 / 0	+46 / 0	+54 / 0
H9	+25 / 0	+30 / 0	+36 / 0	+43 / 0	+52 / 0	+62 / 0	+74 / 0	+87 / 0
H12	+100 / 0	+120 / 0	+150 / 0	+180 / 0	+210 / 0	+250 / 0	+300 / 0	+350 / 0
P9	-6 / -31	-12 / -42	-15 / -51	-18 / -61	-22 / -74	-26 / -86	-32 / -106	-37 / -124
S7	-13 / -22	-15 / -27	-17 / -32	-21 / -39	-27 / -48	-34 / -59	-42 / -72	-58 / -93



GENERAL – TECHNICAL INFO

Table of Cutting Speeds

		Vc															
m/min.		5	8	10	15	20	25	30	40	50	60	70	80	90	100	110	150
SFM (feet/min.)		16	26	32	50	66	82	98	130	165	197	230	262	296	330	362	495
Ø		RPM															
mm	inch																
1.00	–	1592	2546	3183	4775	6366	7958	9549	12732	15916	19099	22282	25465	28648	31831	35014	47747
1.50	–	1061	1698	2122	3183	4244	5305	6366	8488	10610	12732	14854	16977	19099	21221	23343	31831
2.00	–	796	1273	1592	2387	3183	3979	4775	6366	7958	9549	11141	12732	14324	15916	17507	23873
2.50	–	637	1019	1273	1910	2546	3183	3820	5093	6366	7639	8913	10186	11459	12732	14006	19099
3.00	–	531	849	1061	1592	2122	2653	3183	4244	5305	6366	7427	8488	9549	10610	11671	15916
3.18	1/8	500	801	1001	1501	2002	2502	3003	4004	5005	6006	7007	8008	9009	10010	11011	15015
3.50	–	455	728	909	1364	1819	2274	2728	3638	4547	5457	6366	7276	8185	9095	10004	13642
4.00	–	398	637	796	1194	1592	1989	2387	3183	3979	4775	5570	6366	7162	7958	8754	11937
4.50	–	354	566	707	1061	1415	1768	2122	2829	3537	4244	4951	5659	6366	7074	7781	10610
4.76	3/16	334	535	669	1003	1337	1672	2006	2675	3344	4012	4681	5350	6018	6687	7356	10031
5.00	–	318	509	637	955	1273	1592	1910	2546	3183	3820	4456	5093	5730	6366	7003	9549
6.00	–	265	424	531	796	1061	1326	1592	2122	2653	3183	3714	4244	4775	5305	5836	7958
6.35	1/4	251	401	501	752	1003	1253	1504	2005	2506	3008	3509	4010	4511	5013	5514	7519
7.00	–	227	364	455	682	909	1137	1364	1819	2274	2728	3183	3638	4093	4547	5002	6821
7.94	5/16	200	321	401	601	802	1002	1203	1604	2004	2405	2806	3207	3608	4009	4410	6013
8.00	–	199	318	398	597	796	995	1194	1592	1989	2387	2785	3183	3581	3979	4377	5968
9.00	–	177	283	354	531	707	884	1061	1415	1768	2122	2476	2829	3183	3537	3890	5305
9.53	3/8	167	267	334	501	668	835	1002	1336	1670	2004	2338	2672	3006	3340	3674	5010
10.00		159	255	318	477	637	796	955	1273	1592	1910	2228	2546	2865	3183	3501	4775
11.11	7/16	143	229	287	430	573	716	860	1146	1433	1719	2006	2292	2579	2865	3152	4298
12.00		133	212	265	398	531	663	796	1061	1326	1592	1857	2122	2387	2653	2918	3979
12.70	1/2	125	201	251	376	501	627	752	1003	1253	1504	1754	2005	2256	2506	2757	3760
14.00		114	182	227	341	455	568	682	909	1137	1364	1592	1819	2046	2274	2501	3410
14.29	9/16	111	178	223	334	446	557	668	891	1114	1337	1559	1782	2005	2228	2450	3341
15.00	–	106	170	212	318	424	531	637	849	1061	1273	1485	1698	1910	2122	2334	3183
15.88	5/8	100	160	200	301	401	501	601	802	1002	1203	1403	1604	1804	2004	2205	3007
16.00	–	99	159	199	298	398	497	597	796	995	1194	1393	1592	1790	1989	2188	2984
17.46	11/16	91	146	182	273	365	456	547	729	912	1094	1276	1458	1641	1823	2005	2735
18.00	–	88	141	177	265	354	442	531	707	884	1061	1238	1415	1592	1768	1945	2653
19.05	3/4	84	134	167	251	334	418	501	668	835	1003	1170	1337	1504	1671	1838	2506
20.00	–	80	127	159	239	318	398	477	637	796	955	1114	1273	1432	1592	1751	2387
24.00	–	66	106	133	199	265	332	398	531	663	796	928	1061	1194	1326	1459	1989
25.00	–	64	102	127	191	255	318	382	509	637	764	891	1019	1146	1273	1401	1910
27.00	–	59	94	118	177	236	295	354	472	589	707	825	943	1061	1179	1297	1768
30.00	–	53	85	106	159	212	265	318	424	531	637	743	849	955	1061	1167	1592
32.00	–	50	80	99	149	199	249	298	398	497	597	696	796	895	995	1094	1492
36.00	–	44	71	88	133	177	221	265	354	442	531	619	707	796	884	973	1326
40.00	–	40	64	80	119	159	199	239	318	398	477	557	637	716	796	875	1194
50.00	–	32	51	64	95	127	159	191	255	318	382	446	509	573	637	700	955

GENERAL – TECHNICAL INFO

Hardness and Tensile Strength

HV	HRC	HB	Tensile Strength	
			[N/mm ²]	[Tons/ sq. in.]
940	68	–	–	–
900	67	–	–	–
864	66	–	–	–
829	65	–	–	–
800	64	–	–	–
773	63	–	–	–
745	62	–	–	–
720	61	–	–	–
698	60	–	–	–
675	59	–	–	–
655	58	–	2200	142
650	–	618	2180	141
640	–	608	2145	139
639	57	607	2140	138
630	–	599	2105	136
620	–	589	2070	134
615	56	584	2050	133
610	–	580	2030	131
600	–	570	1995	129
596	55	567	1980	128
590	–	561	1955	126
580	–	551	1920	124
578	54	549	1910	124
570	–	542	1880	122
560	53	532	1845	119
550	–	523	1810	117
544	52	517	1790	116
540	–	513	1775	115
530	–	504	1740	113
527	51	501	1730	112
520	–	494	1700	110
514	50	488	1680	109
510	–	485	1665	108
500	–	475	1630	105
497	49	472	1620	105
490	–	466	1595	103
484	48	460	1570	102
480	–	456	1555	101
473	47	449	1530	99
470	–	447	1520	98
460	–	437	1485	96
458	46	435	1480	96
450	–	428	1455	94
446	45	424	1440	93
440	–	418	1420	92

HV	HRC	HB	Tensile Strength	
			[N/mm ²]	[Tons/ sq. in.]
434	44	413	1400	91
423	43	402	1360	88
413	42	393	1330	86
403	41	383	1300	84
392	40	372	1260	82
382	39	363	1230	80
373	38	354	1200	78
364	37	346	1170	76
355	36	337	1140	74
350	–	333	1125	73
345	35	328	1110	72
340	–	323	1095	71
336	34	319	1080	70
330	–	314	1060	69
327	33	311	1050	68
320	–	304	1030	67
317	32	301	1020	66
310	31	295	995	64
302	30	287	970	63
300	–	285	965	62
295	–	280	950	61
293	29	278	940	61
290	–	276	930	60
287	28	273	920	60
285	–	271	915	59
280	27	266	900	58
275	–	261	880	57
272	26	258	870	56
270	–	257	865	56
268	25	255	860	56
265	–	252	850	55
260	24	247	835	54
255	23	242	820	53
250	22	238	800	52
245	–	233	785	51
243	21	231	780	50
240	–	228	770	50
235	–	223	755	49
230	–	219	740	48
225	–	214	720	47
220	–	209	705	46
215	–	204	690	45
210	–	199	675	44
205	–	195	660	43
200	–	190	640	41

HSS TAPS





POCKET SAVER

Our machining calculator allows you to measure the savings based on different products and applications. A useful pocket-sized tool, which will help keep cash in your pockets! **Simply Reliable.**

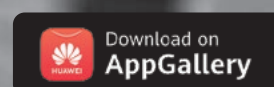
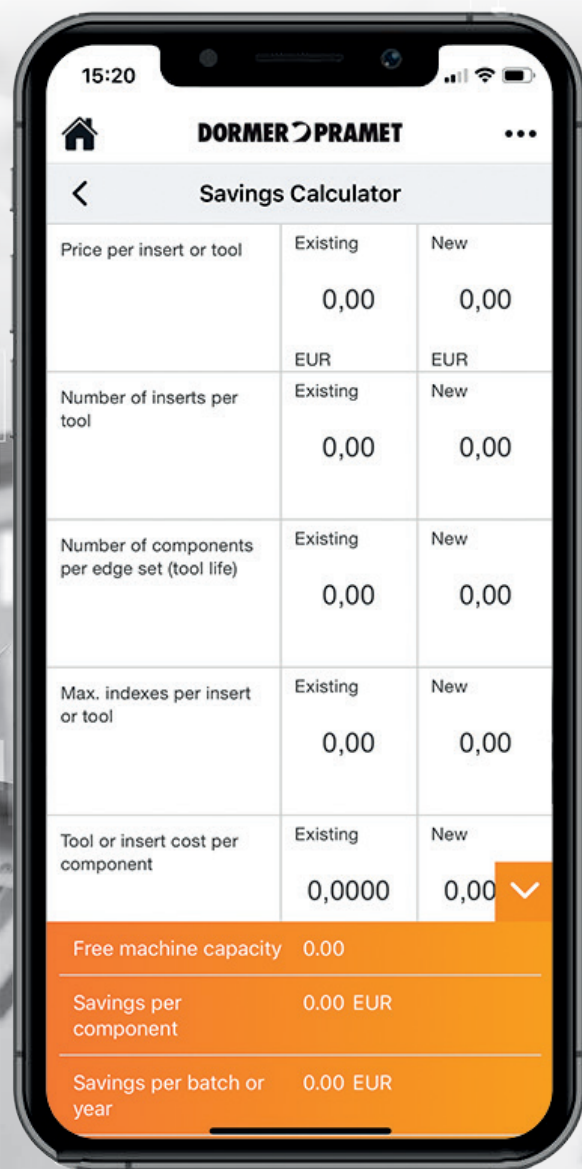

E100

1

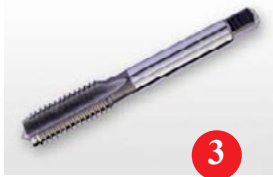

HSS Straight Flute Serial Hand Taps, Metric, DIN Standard, Bright Finish

Ideal for hand tapping tough materials. The straight flute design makes it ideal for both through and blind holes. Available as a single finishing tap or as a set of three serial taps, which should be used one after the other to create the full thread. Bright finish.

2

M	DIN 352	6H
1.5xD	HSS	
C 2-3	R	
Bright		

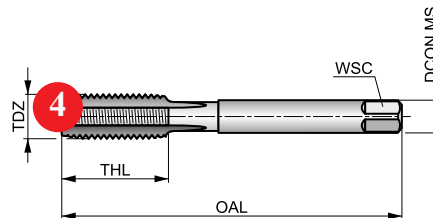

Workpiece material group suitability.

P1.1	P1.2	P1.3	P2.1	P2.2	P2.3	P3.1	P3.2	P4.1	K1.1	K1.2	K1.3	K2.1	K2.2
K3.1	K3.2	K4.1	K4.2	K5.1	K5.2	N1.1	N1.2	N1.3	N2.1	N2.2	N2.3	N3.1	N3.2
N3.3	N4.2	N4.3											

Products from this series are also available in set of sizes or with dies. Please see L119 or L120.

Product	TDZ	TP	OAL	THL	DCON MS	WSC	NOF	PHD
	(mm)	(mm)	(mm)	(mm)	(mm)	(mm)		(mm)
E100M1.6N03	1.6	0.35	32.0	7	2.50	2.10	3	1.25
E100M1.6N08	1.6	0.35	32.0	7	2.50	2.10	3	1.25
E100M2N03	2	0.40	36.0	8	2.80	2.10	3	1.60
E100M2N08	2	0.40	36.0	8	2.80	2.10	3	1.60
E100M2.5N03	2.5	0.45	40.0	9	2.80	2.10	3	2.05
E100M2.5N08	2.5	0.45	40.0	9	2.80	2.10	3	2.05
E100M3N03	3	0.50	40.0	10	3.50	2.70	3	2.50
E100M3N08	3	0.50	40.0	10	3.50	2.70	3	2.50
E100M3.5N03	3.5	0.60	45.0	10	4.00	3.00	3	2.90
E100M3.5N08	3.5	0.60	45.0	10	4.00	3.00	3	2.90
E100M4N03	4	0.70	45.0	12	4.50	3.40	3	3.30
E100M4N08	4	0.70	45.0	12	4.50	3.40	3	3.30

Pos.	Description
1	Designation of taps
2	Product description
3	Illustrative picture
4	Schematic drawing of tool

Pos.	Description
5	Product features
6	Material group recommendations incl. speed and feed guidance
7	Product code
8	Product dimensions



HSS TAPS – ICONS OVERVIEW

General icons



Primary use



Possible use

Basic standard group (BSG)

DIN 2181	DIN 2181 – Hand Tap Standard	DIN 374	DIN 374 – MF Thread Standard	DIN DORMER	DIN Dormer Standard
DIN 351	DIN 351 – Straight Flute Tap Standard	DIN 376	DIN 376 – Thread Form Standard	DIN 371/376	DIN Thread Standard (based on size range) DIN 371 if $\varnothing \leq 10\text{mm}$ / DIN 376 if $\varnothing \geq 12\text{mm}$
DIN 352	DIN 352 – Thread Form Standard	DIN 5156	DIN 5156 – Thread Form Standard	ISO 529	ISO 529 – Tap Standard
DIN 371	DIN 371 – Thread Form Standard	DIN 5157	DIN 5157 – Pipe Thread Standard	ISO DORMER	ISO Dormer Standard





Material code (BMC)

HSS-E PM	High Speed Cobalt Powder Metal Tool Material
HSS-E	High Speed Cobalt Steel Tool Material
HSS	High Speed Steel Tool Material

Coating



	Bright (uncoated)		Steam Tempered (Steam Oxide) Surface Treatment
---	-------------------	---	--

Flute helix angle (FHA)

	27° Helix Angle (Flute)		40° Helix Angle (Flute)
	30° Helix Angle (Flute)		45° Helix Angle (Flute)



HSS TAPS – ICONS OVERVIEW

Flute Geometry (FDC)

	Spiral Flute Geometry
	Spiral Point Geometry

	Straight Flute Geometry
---	-------------------------

Hand (Cutting direction)

	Left Hand Rotation/Cutting
	Right Hand Rotation/Cutting

Tap chamfer style (TCS)

B 3.5-5	Plug Tap Chamfer (3.5 – 5 Pitch Lead)
-------------------	--

C 2-3	Semi-Bottoming Tap Chamfer (2 – 3 Pitch Lead)
-----------------	--

Thread form type (THFT)

NPT	Thread Form, American National Pipe Taper
BA	Thread Form, British Association Screw Threads
BSF	Thread Form, British Standard Fine
G	Thread Form, British Standard Pipe (BSP)

BSW	Thread Form, British Standard Whitworth
M	Thread Form, Metric Coarse
MF	Thread Form, Metric Fine
EGM	Thread Form, Metric ISO (Screw Thread Insert Type)

UNC	Thread Form, Unified Coarse
UNF	Thread Form, Unified Fine

Thread Tolerance Zone class (TCTR)

6H	DIN Thread Pitch Diameter Tolerance Zone (high basic pitch diameter)
6HX	DIN Thread Pitch Diameter Tolerance Zone (with increased pitch diameter)

2B	Internal Inch Thread Medium Class of Fit
Medium	Medium Inch Thread Class of Fit

Normal	Normal Fit Class for Pipe Thread
--------	----------------------------------

Threading application

	Blind Hole Application
	Through Hole Application
	Through or Blind Hole Application



Usable length diameter ratio (ULDR)

1.5×D	1.5×D Useable Tool Depth to Diameter Ratio
2.5×D	2.5×D Useable Tool Depth to Diameter Ratio



2×D	2×D Useable Tool Depth to Diameter Ratio
------------	--

HSS HAND & MACHINE TAPS – TOOL MATERIAL NAVIGATOR

Tool materials

High Speed Steel		<p>A medium-alloyed high speed steel that has good machinability and good performance. HSS exhibits hardness, toughness and wear resistance characteristics that make it attractive in a wide range of applications, for example in drills and taps.</p>
Sintered Cobalt High Speed Steel		<p>HSS-E-PM is a Cobalt High Speed Powder Metal substrate which has been produced using powder metal technology. High speed steel produced by this method exhibits superior toughness and grindability due to the uniform and consistent grain structure. High performance taps and end mills have a particular advantage when manufactured from this substrate.</p>

Surface Treatments

Bright (uncoated)		<p>Bright finish (uncoated surface) improves chip flow in soft or non-ferrous materials and maintains sharp cutting edges in abrasive materials.</p>
Steam Tempering		<p>Steam tempering gives a strongly adhering blue oxide surface that acts to retain cutting fluid and prevent chip to tool welding, thereby counteracting the formation of a built-up edge. Steam tempering can be applied to any bright tool but is most effective on drills and taps.</p>

Thread form (THFT)	M	M	M	MF	UNC	UNF	BSW	G	M	MF	UNC	UNF	BSW
	DIN 352	DIN 352	DIN 352	DIN 2181	DIN 352	DIN 2181	DIN 351	DIN 5157	ISO 529	ISO 529	ISO 529	ISO 529	ISO 529
	6H	6HX	6H	6H	2B	2B	Medium	Normal	6H	6H	2B	2B	Medium
Basic standard group (BSG)	1.5xD	1.5xD	1.5xD	1.5xD	1.5xD	1.5xD	1.5xD	1.5xD	1.5xD	1.5xD	1.5xD	1.5xD	1.5xD
	HSS	HSS-E	HSS	HSS	HSS	HSS	HSS	HSS	HSS	HSS	HSS	HSS	HSS
Thread tolerance class (TCTR)	C 2-3	C 2-3	C 2-3	C 2-3	C 2-3	C 2-3	C 2-3	C 2-3	C 2-3	C 2-3	C 2-3	C 2-3	C 2-3
Threading application													
Usable length (ULDR)													
Material code (BMC)	Bright	ST	Bright	Bright	Bright	Bright	Bright	Bright	Bright	Bright	Bright	Bright	Bright
Tap chamfer style (TCS)													
Flute Geometry (FDC)													
Flute helix angle (FHA)													
Hand (Cutting direction)													
Coating													
Product Family Code	E100	E102	E101	E105	E108	E111	E115	E119	E500	E513	E515	E524	E531
	M1.6 - M52	M3 - M30	M4 - M16	M2.5 - M50	No.5 - 1"	No.5 - 1"	1/8 - 1"	1/8 - 3"	M1 - M56	M3 - M50	No.1 - 2"	No.0 - 1.1/2	1/8 - 1"
	142	144	145	146	149	150	151	152	154	158	162	164	166
P	P1	■	■	■	■	■	■	■	■	■	■	■	■
	P2	■	■	■	■	■	■	■	■	■	■	■	■
	P3	■	■	■	■	■	■	■	■	■	■	■	■
	P4	■	■	■	■	■	■	■	■	■	■	■	■
M	M1		■										
	M2		■										
	M3		■										
	M4		■										
K	K1	■	■	■	■	■	■	■	■	■	■	■	■
	K2	■	■	■	■	■	■	■	■	■	■	■	■
	K3	■	■	■	■	■	■	■	■	■	■	■	■
	K4	■	■	■	■	■	■	■	■	■	■	■	■
	K5	■	■	■	■	■	■	■	■	■	■	■	■
N	N1	■		■	■	■	■	■	■	■	■	■	■
	N2	■		■	■	■	■	■	■	■	■	■	■
	N3	■		■	■	■	■	■	■	■	■	■	■
	N4	■		■	■	■	■	■	■	■	■	■	■
	N5	■		■	■	■	■	■	■	■	■	■	■
S	S1		■										
	S2		■										
	S3		■										
	S4		■										
H	H1												
	H2												
	H3												
	H4												

	BSF	BA	G	EGM	EGM	M	UNC	UNF	NPT			
	ISO 529	ISO 529	ISO 2284	ISO DORMER	ISO DORMER	ISO DORMER	DIN DORMER	DIN DORMER	ANSI			
	Medium	Normal	Normal	6H	6H	6H	2B	Medium	Normal			
	1.5xD	1.5xD	1.5xD	1.5xD	2xD	1.5xD	1.5xD	1.5xD	1.5xD			
	HSS	HSS	HSS	HSS	HSS	HSS	HSS	HSS	HSS			
				C 2-3	C 2-3	C 2-3	C 2-3	C 2-3				
	R	R	R	R	R	R	R	R	R			
	Bright	Bright	Bright	Bright	Bright	ST	ST	ST	Bright			
	E536	E542	E547	E620	E621	E650	E651	E654	E653	L112	L120	L115
	3/16 - 1"	No.10 - No.0	1/8 - 2"	M3 - M16	M3 - M16	M3 - M16	No.6 - 5/8	No.8 - 5/8	1/8 - 1"	BT1 - No.7	Set	Set
	168	170	172	174	175	176	177	178	179	180	181	182
P1	■	■	■	■	■	■	■	■	■			
P2	▣	■	■	■	■	▣	▣	▣	▣			
P3	▣	▣	▣	▣	▣	▣	▣	▣	▣			
P4	▣	▣	▣	▣	▣							
M1												
M2												
M3												
M4												
K1	▣	▣	▣	▣								
K2	▣	▣	▣	▣								
K3	▣	▣	▣	▣								
K4	▣	▣	▣	▣								
K5	▣	▣	▣	▣								
N1	▣	▣	▣	▣		▣	▣	▣	▣			
N2	▣	▣	▣	▣	▣							
N3	■	▣	▣	▣		▣	▣	▣	▣			
N4	▣	▣	▣	▣		▣	▣	▣	▣			
N5												
S1												
S2												
S3												
S4												
H1												
H2												
H3												
H4												

Thread form (THFT)							
Basic standard group (BSG)							
Thread tolerance class (TCTR)							
Threading application							
Usable length (ULDR)							
Material code (BMC)							
Tap chamfer style (TCS)							
Flute Geometry (FDC)							
Flute helix angle (FHA)							
Hand (Cutting direction)							
Coating							
Product Family Code	L126	L119	L000	L001	L002		
	Set	Set	Set	Set	Set		
	183	184	185	186	187		
P	P1						
	P2						
	P3						
	P4						
M	M1						
	M2						
	M3						
	M4						
K	K1						
	K2						
	K3						
	K4						
	K5						
N	N1						
	N2						
	N3						
	N4						
	N5						
S	S1						
	S2						
	S3						
	S4						
H	H1						
	H2						
	H3						
	H4						

E100



HSS Straight Flute Serial Hand Taps, Metric, DIN Standard, Bright Finish

Ideal for hand tapping tough materials. The straight flute design makes it ideal for both through and blind holes. Available as a single finishing tap or as a set of three serial taps, which should be used one after the other to create the full thread. Bright finish.

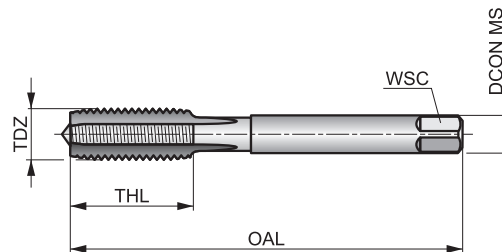

	DIN 352	6H
	1.5xD	HSS
C 2-3		
Bright		

Workpiece material group suitability.

P1.1	P1.2	P1.3	P2.1	P2.2	P2.3	P3.1	P3.2	P4.1	K1.1	K1.2	K1.3	K2.1	K2.2
■	■	■	■	■	■	■	■	■	■	■	■	■	■
K3.1	K3.2	K4.1	K4.2	K5.1	K5.2	N1.1	N1.2	N1.3	N2.1	N2.2	N2.3	N3.1	N3.2
■	■	■	■	■	■	■	■	■	■	■	■	■	■
N3.3	N4.2	N4.3											
■	■	■											

Products from this series are also available in set of sizes or with dies. Please see L119 or L120.

Product	TDZ	TP	OAL	THL	DCON MS	WSC	NOF	PHD
		(mm)	(mm)	(mm)	(mm)	(mm)		(mm)
E100M1.6N03	1.6	0.35	32.0	7	2.50	2.10	3	1.25
E100M1.6N08	1.6	0.35	32.0	7	2.50	2.10	3	1.25
E100M2N03	2	0.40	36.0	8	2.80	2.10	3	1.60
E100M2N08	2	0.40	36.0	8	2.80	2.10	3	1.60
E100M2.5N03	2.5	0.45	40.0	9	2.80	2.10	3	2.05
E100M2.5N08	2.5	0.45	40.0	9	2.80	2.10	3	2.05
E100M3N03	3	0.50	40.0	10	3.50	2.70	3	2.50
E100M3N08	3	0.50	40.0	10	3.50	2.70	3	2.50
E100M3.5N03	3.5	0.60	45.0	10	4.00	3.00	3	2.90
E100M3.5N08	3.5	0.60	45.0	10	4.00	3.00	3	2.90
E100M4N03	4	0.70	45.0	12	4.50	3.40	3	3.30
E100M4N08	4	0.70	45.0	12	4.50	3.40	3	3.30
E100M5N03	5	0.80	50.0	14	6.00	4.90	3	4.20
E100M5N08	5	0.80	50.0	14	6.00	4.90	3	4.20
E100M6N03	6	1.00	56.0	16	6.00	4.90	3	5.00
E100M6N08	6	1.00	56.0	16	6.00	4.90	3	5.00
E100M7N03	7	1.00	56.0	16	6.00	4.90	3	6.00
E100M7N08	7	1.00	56.0	16	6.00	4.90	3	6.00
E100M8N03	8	1.25	63.0	19	6.00	4.90	3	6.80
E100M8N08	8	1.25	63.0	19	6.00	4.90	3	6.80
E100M9N03	9	1.25	63.0	20	7.00	5.50	3	7.80
E100M9N08	9	1.25	63.0	20	7.00	5.50	3	7.80
E100M10N03	10	1.50	70.0	22	7.00	5.50	3	8.50
E100M10N08	10	1.50	70.0	22	7.00	5.50	3	8.50
E100M12N03	12	1.75	75.0	25	9.00	7.00	4	10.30
E100M12N08	12	1.75	75.0	25	9.00	7.00	4	10.30
E100M14N03	14	2.00	80.0	25	11.00	9.00	4	12.00



Product	TDZ	TP	OAL	THL	DCON MS	WSC	NOF	PHD
		(mm)	(mm)	(mm)	(mm)	(mm)		(mm)
E100M14N08	14	2.00	80.0	25	11.00	9.00	4	12.00
E100M16N03	16	2.00	80.0	25	12.00	9.00	4	14.00
E100M16N08	16	2.00	80.0	25	12.00	9.00	4	14.00
E100M18N03	18	2.50	95.0	32	14.00	11.00	4	15.50
E100M18N08	18	2.50	95.0	32	14.00	11.00	4	15.50
E100M20N03	20	2.50	95.0	32	16.00	12.00	4	17.50
E100M20N08	20	2.50	95.0	32	16.00	12.00	4	17.50
E100M22N03	22	2.50	100.0	34	18.00	14.50	4	19.50
E100M22N08	22	2.50	100.0	34	18.00	14.50	4	19.50
E100M24N03	24	3.00	110.0	38	18.00	14.50	4	21.00
E100M24N08	24	3.00	110.0	38	18.00	14.50	4	21.00
E100M27N03	27	3.00	110.0	38	20.00	16.00	4	24.00
E100M27N08	27	3.00	110.0	38	20.00	16.00	4	24.00
E100M30N03	30	3.50	125.0	45	22.00	18.00	4	26.50
E100M30N08	30	3.50	125.0	45	22.00	18.00	4	26.50
E100M33N03	33	3.50	125.0	50	25.00	20.00	4	29.50
E100M33N08	33	3.50	125.0	50	25.00	20.00	4	29.50
E100M36N03	36	4.00	150.0	56	28.00	22.00	4	32.00
E100M36N08	36	4.00	150.0	56	28.00	22.00	4	32.00
E100M39N03	39	4.00	150.0	60	32.00	24.00	4	35.00
E100M39N08	39	4.00	150.0	60	32.00	24.00	4	35.00
E100M42N03	42	4.50	150.0	60	32.00	24.00	4	37.50
E100M42N08	42	4.50	150.0	60	32.00	24.00	4	37.50
E100M45N03	45	4.50	160.0	65	36.00	29.00	6	40.50
E100M45N08	45	4.50	160.0	65	36.00	29.00	6	40.50
E100M48N03	48	5.00	180.0	70	36.00	29.00	6	43.00
E100M48N08	48	5.00	180.0	70	36.00	29.00	6	43.00
E100M52N03	52	5.00	180.0	70	40.00	32.00	6	47.00
E100M52N08	52	5.00	180.0	70	40.00	32.00	6	47.00

E102



HSS-E Straight Flute Serial Hand Taps, Metric, DIN Standard

Ideal for hand tapping tough materials. The straight flute design makes it ideal for both through and blind holes. Available as a set of three serial taps, which should be used one after the other to create the full thread. Steam tempered surface acts to retain cutting fluid to improve lubrication and provide smoother cutting.

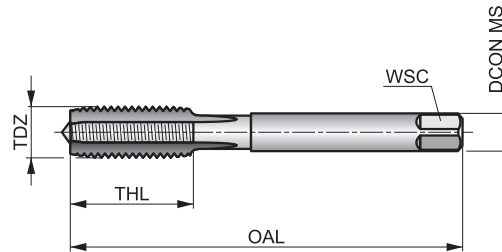

	DIN 352	6HX
	1.5xD	HSS-E

Workpiece material group suitability.

P1.1	P1.2	P1.3	P2.1	P2.2	P2.3	P3.1	P3.2	P3.3	P4.1	P4.2	M1.1	M1.2	M2.1
☑	☑	☑	☑	☑	☑	☑	☑	☑	☑	☑	☑	☑	☑
M2.2	M3.1	M3.2	M3.3	M4.1	K1.1	K1.2	K1.3	K2.1	K2.2	K2.3	K3.1	K3.2	K3.3
☑	☑	☑	☑	☑	☑	☑	☑	☑	☑	☑	☑	☑	☑
K4.1	K4.2	K4.3	K5.1	K5.2	K5.3	S1.1	S2.1	S3.1	S4.1				
☑	☑	☑	☑	☑	☑	☑	☑	☑	☑				

No4 with pilot guide.

Product	TDZ	TP	OAL	THL	DCON MS	WSC	NOF	PHD
		(mm)	(mm)	(mm)	(mm)	(mm)		(mm)
E102M3N08	3	0.50	40.0	10	3.50	2.70	3	2.50
E102M4N08	4	0.70	45.0	12	4.50	3.40	3	3.30
E102M5N08	5	0.80	50.0	14	6.00	4.90	3	4.20
E102M6N08	6	1.00	56.0	16	6.00	4.90	3	5.00
E102M8N08	8	1.25	63.0	19	6.00	4.90	3	6.80
E102M10N08	10	1.50	70.0	22	7.00	5.50	3	8.50
E102M12N08	12	1.75	75.0	25	9.00	7.00	4	10.30
E102M14N08	14	2.00	80.0	25	11.00	9.00	4	12.00
E102M16N08	16	2.00	80.0	25	12.00	9.00	4	14.00
E102M18N08	18	2.50	95.0	32	14.00	11.00	4	15.50
E102M20N08	20	2.50	95.0	32	16.00	12.00	4	17.50
E102M24N08	24	3.00	110.0	38	18.00	14.50	4	21.00
E102M27N08	27	3.00	110.0	38	20.00	16.00	4	24.00
E102M30N08	30	3.50	125.0	45	22.00	18.00	4	26.50

E101

HSS Straight Flute Serial Hand Taps, Metric, DIN Standard, Left-Handed

Ideal for hand tapping tough materials. The straight flute design makes it ideal for both through and blind holes. Available as a single finishing tap or as a set of three serial taps, which should be used one after the other to create the full thread. Bright finish.

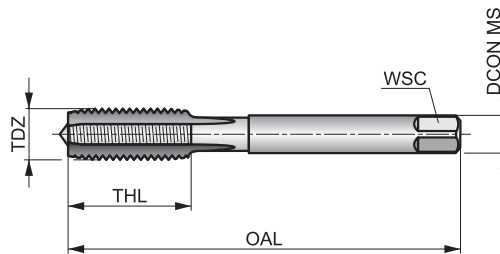

M	DIN 352	6H
	1.5×D	HSS
C 2-3		
Bright		

Workpiece material group suitability.

P1.1	P1.2	P1.3	P2.1	P2.2	P2.3	P3.1	P3.2	P4.1	K1.1	K1.2	K1.3	K2.1	K2.2
■	■	■	■	■	☑	■	☑	☑	☑	☑	☑	☑	☑
K3.1	K3.2	K4.1	K4.2	K5.1	K5.2	N1.1	N1.2	N1.3	N2.1	N2.2	N2.3	N3.1	N3.2
☑	☑	☑	☑	☑	☑	■	■	■	■	■	■	■	■
N3.3	N4.2	N4.3											
■	■	■											

Product	TDZ	TP	OAL	THL	DCON MS	WSC	NOF	PHD
		(mm)	(mm)	(mm)	(mm)	(mm)		(mm)
E101M4N03	4	0.70	45.0	12	4.50	3.40	3	3.30
E101M4N08	4	0.70	45.0	12	4.50	3.40	3	3.30
E101M5N03	5	0.80	50.0	14	6.00	4.90	3	4.20
E101M5N08	5	0.80	50.0	14	6.00	4.90	3	4.20
E101M6N03	6	1.00	56.0	16	6.00	4.90	3	5.00
E101M6N08	6	1.00	56.0	16	6.00	4.90	3	5.00
E101M8N03	8	1.25	63.0	19	6.00	4.90	3	6.80
E101M8N08	8	1.25	63.0	19	6.00	4.90	3	6.80
E101M10N03	10	1.50	70.0	22	7.00	5.50	3	8.50
E101M10N08	10	1.50	70.0	22	7.00	5.50	3	8.50
E101M12N03	12	1.75	75.0	25	9.00	7.00	4	10.30
E101M12N08	12	1.75	75.0	25	9.00	7.00	4	10.30
E101M14N03	14	2.00	80.0	25	11.00	9.00	4	12.00
E101M14N08	14	2.00	80.0	25	11.00	9.00	4	12.00
E101M16N03	16	2.00	80.0	25	12.00	9.00	4	14.00
E101M16N08	16	2.00	80.0	25	12.00	9.00	4	14.00

E105



HSS Straight Flute Serial Hand Tap, Metric-Fine, DIN Standard

Ideal for hand tapping tough materials. The straight flute design makes it ideal for both through and blind holes. Available as a single finishing tap or as a set of two serial taps, which should be used one after the other to create the full thread.

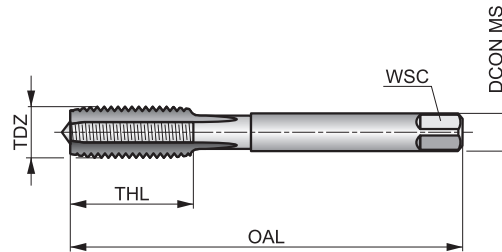

MF	DIN 2181	6H
	1.5xD	HSS
C 2-3		R
Bright		

Workpiece material group suitability.

P1.1	P1.2	P1.3	P2.1	P2.2	P2.3	P3.1	P3.2	P4.1	K1.1	K1.2	K1.3	K2.1	K2.2
■	■	■	■	■	■	■	■	■	■	■	■	■	■
K3.1	K3.2	K4.1	K4.2	K5.1	K5.2	N1.1	N1.2	N1.3	N2.1	N2.2	N2.3	N3.1	N3.2
■	■	■	■	■	■	■	■	■	■	■	■	■	■
N3.3	N4.2	N4.3											
■	■	■											

Product	TDZ	TP	OAL	THL	DCON MS	WSC	NOF	PHD
		(mm)	(mm)	(mm)	(mm)	(mm)		(mm)
E105M2.5X.35N03	2.5	0.35	40.0	9	2.80	2.10	3	2.15
E105M2.5X.35N09	2.5	0.35	40.0	9	2.80	2.10	3	2.15
E105M3X.35N03	3	0.35	40.0	9	3.50	2.70	3	2.65
E105M3X.35N09	3	0.35	40.0	9	3.50	2.70	3	2.65
E105M3.5X.35N03	3.5	0.35	45.0	10	4.00	3.00	3	3.20
E105M3.5X.35N09	3.5	0.35	45.0	10	4.00	3.00	3	3.20
E105M4X.5N03	4	0.50	45.0	12	4.50	3.40	3	3.50
E105M4X.5N09	4	0.50	45.0	12	4.50	3.40	3	3.50
E105M5X.5N03	5	0.50	50.0	14	6.00	4.90	3	4.50
E105M5X.5N09	5	0.50	50.0	14	6.00	4.90	3	4.50
E105M5.5X.5N09	5.5	0.50	56.0	16	6.00	4.90	3	5.00
E105M6X.75N03	6	0.75	56.0	16	6.00	4.90	3	5.30
E105M6X.75N09	6	0.75	56.0	16	6.00	4.90	3	5.30
E105M7X.75N03	7	0.75	56.0	16	6.00	4.90	3	6.30
E105M7X.75N09	7	0.75	56.0	16	6.00	4.90	3	6.30
E105M8X.75N03	8	0.75	56.0	16	6.00	4.90	3	7.30
E105M8X.75N09	8	0.75	56.0	16	6.00	4.90	3	7.30
E105M8X1.0N03	8	1.00	63.0	19	6.00	4.90	3	7.00
E105M8X1.0N09	8	1.00	63.0	19	6.00	4.90	3	7.00
E105M9X.75N03	9	0.75	63.0	19	7.00	5.50	3	8.30
E105M9X.75N09	9	0.75	63.0	19	7.00	5.50	3	8.30
E105M9X1.0N03	9	1.00	63.0	19	7.00	5.50	3	8.00
E105M9X1.0N09	9	1.00	63.0	19	7.00	5.50	3	8.00
E105M10X.75N03	10	0.75	63.0	16	7.00	5.50	3	9.30
E105M10X.75N09	10	0.75	63.0	16	7.00	5.50	3	9.30
E105M10X1.0N03	10	1.00	63.0	16	7.00	5.50	3	9.00
E105M10X1.0N09	10	1.00	63.0	16	7.00	5.50	3	9.00
E105M10X1.25N03	10	1.25	70.0	22	7.00	5.50	3	8.80



Product	TDZ	TP	OAL	THL	DCON MS	WSC	NOF	PHD
		(mm)	(mm)	(mm)	(mm)	(mm)		(mm)
E105M10X1.25N09	10	1.25	70.0	22	7.00	5.50	3	8.80
E105M11X.75N03	11	0.75	63.0	15	8.00	6.20	3	10.30
E105M11X.75N09	11	0.75	63.0	15	8.00	6.20	3	10.30
E105M11X1.0N03	11	1.00	63.0	15	8.00	6.20	3	10.00
E105M11X1.0N09	11	1.00	63.0	15	8.00	6.20	3	10.00
E105M12X1.0N03	12	1.00	70.0	16	9.00	7.00	3	11.00
E105M12X1.0N09	12	1.00	70.0	16	9.00	7.00	3	11.00
E105M12X1.25N03	12	1.25	70.0	16	9.00	7.00	3	10.80
E105M12X1.25N09	12	1.25	70.0	16	9.00	7.00	3	10.80
E105M12X1.5N03	12	1.50	70.0	16	9.00	7.00	3	10.50
E105M12X1.5N09	12	1.50	70.0	16	9.00	7.00	3	10.50
E105M14X1.0N03	14	1.00	70.0	16	11.00	9.00	4	13.00
E105M14X1.0N09	14	1.00	70.0	16	11.00	9.00	4	13.00
E105M14X1.25N03	14	1.25	70.0	16	11.00	9.00	4	12.80
E105M14X1.25N09	14	1.25	70.0	16	11.00	9.00	4	12.80
E105M14X1.5N03	14	1.50	70.0	16	11.00	9.00	4	12.50
E105M14X1.5N09	14	1.50	70.0	16	11.00	9.00	4	12.50
E105M15X1.0N03	15	1.00	70.0	16	12.00	9.00	4	14.00
E105M15X1.0N09	15	1.00	70.0	16	12.00	9.00	4	14.00
E105M15X1.5N03	15	1.50	70.0	16	12.00	9.00	4	13.50
E105M15X1.5N09	15	1.50	70.0	16	12.00	9.00	4	13.50
E105M16X1.0N03	16	1.00	70.0	16	12.00	9.00	4	15.00
E105M16X1.0N09	16	1.00	70.0	16	12.00	9.00	4	15.00
E105M16X1.5N03	16	1.50	70.0	16	12.00	9.00	4	14.50
E105M16X1.5N09	16	1.50	70.0	16	12.00	9.00	4	14.50
E105M18X1.0N03	18	1.00	80.0	18	14.00	11.00	4	17.00
E105M18X1.0N09	18	1.00	80.0	18	14.00	11.00	4	17.00
E105M18X1.5N03	18	1.50	80.0	18	14.00	11.00	4	16.50
E105M18X1.5N09	18	1.50	80.0	18	14.00	11.00	4	16.50
E105M20X1.0N03	20	1.00	80.0	18	16.00	12.00	4	19.00
E105M20X1.0N09	20	1.00	80.0	18	16.00	12.00	4	19.00
E105M20X1.5N03	20	1.50	80.0	18	16.00	12.00	4	18.50
E105M20X1.5N09	20	1.50	80.0	18	16.00	12.00	4	18.50
E105M22X1.0N03	22	1.00	80.0	22	18.00	14.50	4	21.00
E105M22X1.0N09	22	1.00	80.0	22	18.00	14.50	4	21.00
E105M22X1.5N03	22	1.50	80.0	22	18.00	14.50	4	20.50
E105M22X1.5N09	22	1.50	80.0	22	18.00	14.50	4	20.50
E105M24X1.0N03	24	1.00	90.0	22	18.00	14.50	4	23.00
E105M24X1.0N09	24	1.00	90.0	22	18.00	14.50	4	23.00
E105M24X1.5N03	24	1.50	90.0	22	18.00	14.50	4	22.50
E105M24X1.5N09	24	1.50	90.0	22	18.00	14.50	4	22.50
E105M24X2.0N03	24	2.00	90.0	22	18.00	14.50	4	22.00
E105M24X2.0N09	24	2.00	90.0	22	18.00	14.50	4	22.00
E105M25X1.5N03	25	1.50	90.0	22	18.00	14.50	4	23.50
E105M25X1.5N09	25	1.50	90.0	22	18.00	14.50	4	23.50
E105M25X2.0N03	25	2.00	90.0	22	18.00	14.50	4	23.00
E105M25X2.0N09	25	2.00	90.0	22	18.00	14.50	4	23.00
E105M27X1.5N03	27	1.50	90.0	22	20.00	16.00	4	25.50
E105M27X1.5N09	27	1.50	90.0	22	20.00	16.00	4	25.50
E105M27X2.0N03	27	2.00	90.0	22	20.00	16.00	4	25.00
E105M27X2.0N09	27	2.00	90.0	22	20.00	16.00	4	25.00
E105M28X1.5N03	28	1.50	90.0	22	20.00	16.00	4	26.50
E105M28X1.5N09	28	1.50	90.0	22	20.00	16.00	4	26.50
E105M28X2.0N03	28	2.00	90.0	22	20.00	16.00	4	26.00
E105M28X2.0N09	28	2.00	90.0	22	20.00	16.00	4	26.00
E105M30X1.5N03	30	1.50	90.0	22	22.00	18.00	4	28.50
E105M30X1.5N09	30	1.50	90.0	22	22.00	18.00	4	28.50
E105M30X2.0N03	30	2.00	90.0	22	22.00	18.00	4	28.00
E105M30X2.0N09	30	2.00	90.0	22	22.00	18.00	4	28.00
E105M32X1.5N03	32	1.50	90.0	22	22.00	18.00	4	30.50
E105M32X1.5N09	32	1.50	90.0	22	22.00	18.00	4	30.50
E105M32X2.0N03	32	2.00	90.0	22	22.00	18.00	4	30.00



Product	TDZ	TP	OAL	THL	DCON MS	WSC	NOF	PHD
		(mm)	(mm)	(mm)	(mm)	(mm)		(mm)
E105M32X2.0N09	32	2.00	90.0	22	22.00	18.00	4	30.00
E105M36X1.5N03	36	1.50	100.0	25	28.00	22.00	4	34.50
E105M36X1.5N09	36	1.50	100.0	25	28.00	22.00	4	34.50
E105M36X2.0N03	36	2.00	125.0	40	28.00	22.00	4	34.00
E105M36X2.0N09	36	2.00	125.0	40	28.00	22.00	4	34.00
E105M36X3.0N03	36	3.00	125.0	40	28.00	22.00	4	33.00
E105M36X3.0N09	36	3.00	125.0	40	28.00	22.00	4	33.00
E105M40X1.5N03	40	1.50	110.0	25	32.00	24.00	4	38.50
E105M40X1.5N09	40	1.50	110.0	25	32.00	24.00	4	38.50
E105M40X2.0N03	40	2.00	125.0	40	32.00	24.00	4	38.00
E105M40X2.0N09	40	2.00	125.0	40	32.00	24.00	4	38.00
E105M40X3.0N03	40	3.00	125.0	40	32.00	24.00	4	37.00
E105M40X3.0N09	40	3.00	125.0	40	32.00	24.00	4	37.00
E105M42X1.5N03	42	1.50	110.0	25	32.00	24.00	4	40.50
E105M42X1.5N09	42	1.50	110.0	25	32.00	24.00	4	40.50
E105M42X2.0N03	42	2.00	125.0	40	32.00	24.00	4	40.00
E105M42X2.0N09	42	2.00	125.0	40	32.00	24.00	4	40.00
E105M42X3.0N03	42	3.00	125.0	40	32.00	24.00	4	39.00
E105M42X3.0N09	42	3.00	125.0	40	32.00	24.00	4	39.00
E105M45X1.5N03	45	1.50	110.0	25	36.00	29.00	6	43.50
E105M45X1.5N09	45	1.50	110.0	25	36.00	29.00	6	43.50
E105M45X2.0N03	45	2.00	125.0	40	36.00	29.00	6	43.00
E105M45X2.0N09	45	2.00	125.0	40	36.00	29.00	6	43.00
E105M45X3.0N03	45	3.00	125.0	40	36.00	29.00	6	42.00
E105M45X3.0N09	45	3.00	125.0	40	36.00	29.00	6	42.00
E105M48X1.5N03	48	1.50	140.0	40	36.00	29.00	6	46.50
E105M48X1.5N09	48	1.50	140.0	40	36.00	29.00	6	46.50
E105M48X2.0N03	48	2.00	140.0	40	36.00	29.00	6	46.00
E105M48X2.0N09	48	2.00	140.0	40	36.00	29.00	6	46.00
E105M48X3.0N03	48	3.00	140.0	40	36.00	29.00	6	45.00
E105M48X3.0N09	48	3.00	140.0	40	36.00	29.00	6	45.00
E105M50X1.5N03	50	1.50	140.0	40	36.00	29.00	6	48.50
E105M50X1.5N09	50	1.50	140.0	40	36.00	29.00	6	48.50
E105M50X2.0N03	50	2.00	140.0	40	36.00	29.00	6	48.00
E105M50X2.0N09	50	2.00	140.0	40	36.00	29.00	6	48.00
E105M50X3.0N03	50	3.00	140.0	40	36.00	29.00	6	47.00
E105M50X3.0N09	50	3.00	140.0	40	36.00	29.00	6	47.00

E108

HSS Straight Flute Serial Hand Tap, UNC, DIN Standard

Ideal for hand tapping tough materials. The straight flute design makes it ideal for both through and blind holes. Available as a single finishing tap or as a set of three serial taps, which should be used one after the other to create the full thread.

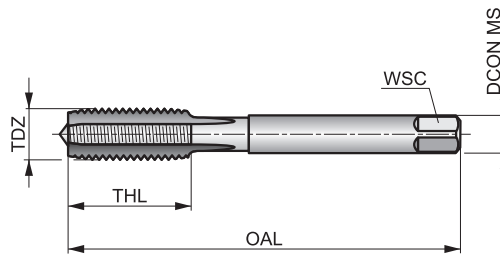

	DIN 352	2B
	1.5xD	HSS
C 2-3		
Bright		

Workpiece material group suitability.

P1.1	P1.2	P1.3	P2.1	P2.2	P2.3	P3.1	P3.2	P4.1	K1.1	K1.2	K1.3	K2.1	K2.2
■	■	■	■	■	■	■	■	■	■	■	■	■	■
K3.1	K3.2	K4.1	K4.2	K5.1	K5.2	N1.1	N1.2	N1.3	N2.1	N2.2	N2.3	N3.1	N3.2
■	■	■	■	■	■	■	■	■	■	■	■	■	■
N3.3	N4.2	N4.3											
■	■	■											

Product	TDZ	TPI	TD	OAL	THL	DCON MS	WSC	NOF	PHD
			(mm)	(mm)	(mm)	(mm)	(mm)		
E1085-40N03	5	40	3.180	45.0	13	4.00	3.00	3	2.65
E1085-40N08	5	40	3.180	45.0	13	4.00	3.00	3	2.65
E1086-32N03	6	32	3.510	45.0	10	4.00	3.00	3	2.85
E1086-32N08	6	32	3.510	45.0	10	4.00	3.00	3	2.85
E1088-32N03	8	32	4.170	50.0	14	6.00	4.90	3	3.50
E1088-32N08	8	32	4.170	50.0	14	6.00	4.90	3	3.50
E10810-24N03	10	24	4.830	50.0	14	6.00	4.90	3	3.90
E10810-24N08	10	24	4.830	50.0	14	6.00	4.90	3	3.90
E10812-24N03	12	24	5.490	56.0	16	6.00	4.90	3	4.50
E10812-24N08	12	24	5.490	56.0	16	6.00	4.90	3	4.50
E1081/4N03	1/4	20	6.350	56.0	17	6.00	4.90	3	5.10
E1081/4N08	1/4	20	6.350	56.0	17	6.00	4.90	3	5.10
E1085/16N03	5/16	18	7.940	63.0	19	6.00	4.90	3	6.60
E1085/16N08	5/16	18	7.940	63.0	19	6.00	4.90	3	6.60
E1083/8N03	3/8	16	9.530	70.0	22	7.00	5.50	3	8.00
E1083/8N08	3/8	16	9.530	70.0	22	7.00	5.50	3	8.00
E1087/16N03	7/16	14	11.110	75.0	30	8.00	6.20	3	9.40
E1087/16N08	7/16	14	11.110	75.0	30	8.00	6.20	3	9.40
E1081/2N03	1/2	13	12.700	75.0	27	9.00	7.00	3	10.80
E1081/2N08	1/2	13	12.700	75.0	27	9.00	7.00	3	10.80
E1089/16N03	9/16	12	14.290	80.0	30	11.00	9.00	4	12.20
E1089/16N08	9/16	12	14.290	80.0	30	11.00	9.00	4	12.20
E1085/8N03	5/8	11	15.880	80.0	32	12.00	9.00	4	13.50
E1085/8N08	5/8	11	15.880	80.0	32	12.00	9.00	4	13.50
E1083/4N03	3/4	10	19.050	95.0	34	14.00	11.00	4	16.50
E1083/4N08	3/4	10	19.050	95.0	34	14.00	11.00	4	16.50
E1087/8N03	7/8	9	22.230	110.0	38	18.00	14.50	4	19.50
E1087/8N08	7/8	9	22.230	110.0	38	18.00	14.50	4	19.50
E1081N08	1"	8	25.400	110.0	38	20.00	16.00	4	22.25

E111

HSS Straight Flute Serial Hand Tap, UNF, DIN Standard

Ideal for hand tapping tough materials. The straight flute design makes it suited for both through and blind holes. Available as a single finishing tap or as a set of two serial taps, which should be used one after the other to create the full thread.

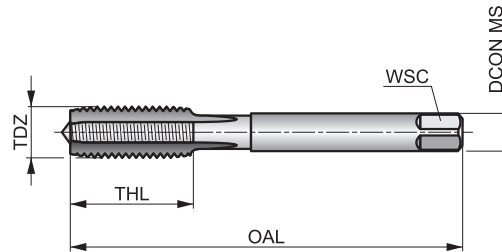

	DIN 2181	2B
	1.5xD	HSS
C 2-3		
Bright		

Workpiece material group suitability.

P1.1	P1.2	P1.3	P2.1	P2.2	P2.3	P3.1	P3.2	P4.1	K1.1	K1.2	K1.3	K2.1	K2.2
■	■	■	■	■	■	■	■	■	■	■	■	■	■
K3.1	K3.2	K4.1	K4.2	K5.1	K5.2	N1.1	N1.2	N1.3	N2.1	N2.2	N2.3	N3.1	N3.2
■	■	■	■	■	■	■	■	■	■	■	■	■	■
N3.3	N4.2	N4.3											
■	■	■											

Product	TDZ	TPI	TD	OAL	THL	DCON MS	WSC	NOF	PHD
			(mm)	(mm)	(mm)	(mm)	(mm)		(mm)
E1115-44N03	5	44	3.180	45.0	13	4.00	3.00	3	2.70
E1115-44N09	5	44	3.180	45.0	13	4.00	3.00	3	2.70
E1116-40N03	6	40	3.510	45.0	10	4.00	3.00	3	2.95
E1116-40N09	6	40	3.510	45.0	10	4.00	3.00	3	2.95
E1118-36N03	8	36	4.170	50.0	14	6.00	4.90	3	3.50
E1118-36N09	8	36	4.170	50.0	14	6.00	4.90	3	3.50
E11110-32N03	10	32	4.820	50.0	14	6.00	4.90	3	4.10
E11110-32N09	10	32	4.820	50.0	14	6.00	4.90	3	4.10
E1111/4N03	1/4	28	6.350	56.0	17	6.00	4.90	3	5.50
E1111/4N09	1/4	28	6.350	56.0	17	6.00	4.90	3	5.50
E1115/16N03	5/16	24	7.940	63.0	19	6.00	4.90	3	6.90
E1115/16N09	5/16	24	7.940	63.0	19	6.00	4.90	3	6.90
E1113/8N03	3/8	24	9.530	63.0	16	7.00	5.50	3	8.50
E1113/8N09	3/8	24	9.530	63.0	16	7.00	5.50	3	8.50
E1117/16N03	7/16	20	11.110	63.0	15	8.00	6.20	3	9.90
E1117/16N09	7/16	20	11.110	63.0	15	8.00	6.20	3	9.90
E1111/2N03	1/2	20	12.700	70.0	22	9.00	7.00	3	11.50
E1111/2N09	1/2	20	12.700	70.0	22	9.00	7.00	3	11.50
E1119/16N03	9/16	18	14.290	70.0	16	11.00	9.00	4	12.90
E1119/16N09	9/16	18	14.290	70.0	16	11.00	9.00	4	12.90
E1115/8N03	5/8	18	15.880	70.0	16	12.00	9.00	4	14.50
E1115/8N09	5/8	18	15.880	70.0	16	12.00	9.00	4	14.50
E1113/4N03	3/4	16	19.050	80.0	22	14.00	11.00	4	17.50
E1113/4N09	3/4	16	19.050	80.0	22	14.00	11.00	4	17.50
E1117/8N03	7/8	14	22.230	90.0	22	18.00	14.50	4	20.40
E1117/8N09	7/8	14	22.230	90.0	22	18.00	14.50	4	20.40
E1111N03	1"	12	25.400	90.0	22	20.00	16.00	4	23.25
E1111N09	1"	12	25.400	90.0	22	20.00	16.00	4	23.25

E115

HSS Straight Flute Serial Hand Tap, BSW, DIN352 Standard

Ideal for hand tapping tough materials. The straight flute design makes it ideal for both through and blind holes. Available as a single finishing tap or as a set of three serial taps, which should be used one after the other to create the full thread.

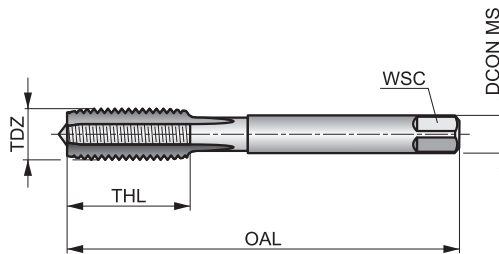

	DIN 351	Medium
	1.5xD	HSS
C 2-3		
Bright		

Workpiece material group suitability.

P1.1	P1.2	P1.3	P2.1	P2.2	P2.3	P3.1	P3.2	P4.1	K1.1	K1.2	K1.3	K2.1	K2.2
■	■	■	■	■	■	■	■	■	■	■	■	■	■
K3.1	K3.2	K4.1	K4.2	K5.1	K5.2	N1.1	N1.2	N1.3	N2.1	N2.2	N2.3	N3.1	N3.2
■	■	■	■	■	■	■	■	■	■	■	■	■	■
N3.3	N4.2	N4.3											
■	■	■											

Product	TDZ	TPI	TD	OAL	THL	DCON MS	WSC	NOF	PHD
			(mm)	(mm)	(mm)	(mm)	(mm)		(mm)
E1151/8N03	1/8	40	3.175	40.0	10	3.50	2.70	3	2.55
E1151/8N08	1/8	40	3.175	40.0	10	3.50	2.70	3	2.55
E1155/32N03	5/32	32	3.969	45.0	12	4.50	3.40	3	3.20
E1155/32N08	5/32	32	3.969	45.0	12	4.50	3.40	3	3.20
E1153/16N03	3/16	24	4.763	50.0	16	5.50	4.30	3	3.70
E1153/16N08	3/16	24	4.763	50.0	16	5.50	4.30	3	3.70
E1151/4N03	1/4	20	6.350	56.0	17	6.00	4.90	3	5.10
E1151/4N08	1/4	20	6.350	56.0	17	6.00	4.90	3	5.10
E1155/16N03	5/16	18	7.938	63.0	25	6.00	4.90	3	6.50
E1155/16N08	5/16	18	7.938	63.0	25	6.00	4.90	3	6.50
E1153/8N03	3/8	16	9.525	70.0	22	7.00	5.50	3	7.90
E1153/8N08	3/8	16	9.525	70.0	22	7.00	5.50	3	7.90
E1157/16N03	7/16	14	11.113	75.0	30	8.00	6.20	3	9.20
E1157/16N08	7/16	14	11.113	75.0	30	8.00	6.20	3	9.20
E1151/2N03	1/2	12	12.700	80.0	30	9.00	7.00	3	10.50
E1151/2N08	1/2	12	12.700	80.0	30	9.00	7.00	3	10.50
E1159/16N03	9/16	12	14.288	80.0	30	11.00	9.00	4	12.00
E1159/16N08	9/16	12	14.288	80.0	30	11.00	9.00	4	12.00
E1155/8N03	5/8	11	15.875	90.0	36	12.00	9.00	4	13.50
E1155/8N08	5/8	11	15.875	90.0	36	12.00	9.00	4	13.50
E1153/4N03	3/4	10	19.050	105.0	40	14.00	11.00	4	16.50
E1153/4N08	3/4	10	19.050	105.0	40	14.00	11.00	4	16.50
E1157/8N03	7/8	9	22.225	110.0	45	18.00	14.50	4	19.25
E1157/8N08	7/8	9	22.225	110.0	45	18.00	14.50	4	19.25
E1151N03	1"	8	25.400	110.0	50	20.00	16.00	4	22.00
E1151N08	1"	8	25.400	110.0	50	20.00	16.00	4	22.00

E119



HSS Straight Flute Serial Hand Tap, G(BSP), DIN Standard

Ideal for hand tapping tough materials. The straight flute design makes it ideal for both through and blind holes. Available as a single finishing tap or as a set of two serial taps, which should be used one after the other to create the full thread.

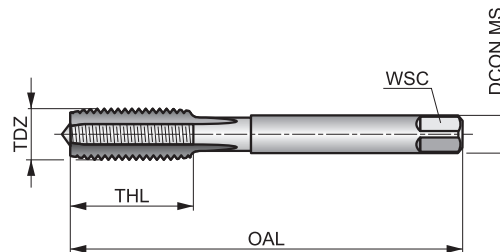

	DIN 5157	Normal
	1.5xD	HSS
C 2-3		
Bright		

Workpiece material group suitability.

P1.1	P1.2	P1.3	P2.1	P2.2	P2.3	P3.1	P3.2	P4.1	K1.1	K1.2	K1.3	K2.1	K2.2
■	■	■	■	■	■	■	■	■	■	■	■	■	■
K3.1	K3.2	K4.1	K4.2	K5.1	K5.2	N1.1	N1.2	N1.3	N2.1	N2.2	N2.3	N3.1	N3.2
■	■	■	■	■	■	■	■	■	■	■	■	■	■
N3.3	N4.2	N4.3											
■	■	■											

Product	TDZ	TPI	TD	OAL	THL	DCON MS	WSC	NOF	PHD
			(mm)	(mm)	(mm)	(mm)	(mm)		(mm)
E1191/8N03	1/8	28	9.730	63.0	15	7.00	5.50	3	8.80
E1191/8N09	1/8	28	9.730	63.0	15	7.00	5.50	3	8.80
E1191/4N03	1/4	19	13.160	70.0	16	11.00	9.00	4	11.80
E1191/4N09	1/4	19	13.160	70.0	16	11.00	9.00	4	11.80
E1193/8N03	3/8	19	16.660	70.0	16	12.00	9.00	4	15.25
E1193/8N09	3/8	19	16.660	70.0	16	12.00	9.00	4	15.25
E1191/2N03	1/2	14	20.960	80.0	18	16.00	12.00	4	19.00
E1191/2N09	1/2	14	20.960	80.0	18	16.00	12.00	4	19.00
E1195/8N03	5/8	14	22.910	80.0	22	18.00	14.50	4	21.00
E1195/8N09	5/8	14	22.910	80.0	22	18.00	14.50	4	21.00
E1193/4N03	3/4	14	26.440	90.0	22	20.00	16.00	4	24.50
E1193/4N09	3/4	14	26.440	90.0	22	20.00	16.00	4	24.50
E1197/8N03	7/8	14	30.200	90.0	22	22.00	18.00	6	28.25
E1197/8N09	7/8	14	30.200	90.0	22	22.00	18.00	6	28.25
E1191N03	1"	11	33.250	100.0	25	25.00	20.00	6	30.75
E1191N09	1"	11	33.250	100.0	25	25.00	20.00	6	30.75
E1191.1/8N03	1.1/8	11	37.900	125.0	40	28.00	22.00	6	35.00
E1191.1/8N09	1.1/8	11	37.900	125.0	40	28.00	22.00	6	35.00
E1191.1/4N03	1.1/4	11	41.910	125.0	40	32.00	24.00	6	39.50
E1191.1/4N09	1.1/4	11	41.910	125.0	40	32.00	24.00	6	39.50
E1191.1/2N03	1.1/2	11	47.800	140.0	40	36.00	29.00	6	45.00
E1191.1/2N09	1.1/2	11	47.800	140.0	40	36.00	29.00	6	45.00
E1191.3/4N03	1.3/4	11	53.750	140.0	40	40.00	32.00	6	51.00
E1191.3/4N09	1.3/4	11	53.750	140.0	40	40.00	32.00	6	51.00
E1192N03	2"	11	59.610	160.0	40	45.00	35.00	6	57.00
E1192N09	2"	11	59.610	160.0	40	45.00	35.00	6	57.00
E1192.1/4N03	2.1/4	11	65.710	160.0	40	50.00	39.00	6	63.00
E1192.1/4N09	2.1/4	11	65.710	160.0	40	50.00	39.00	6	63.00



Product	TDZ	TPI	TD	OAL	THL	DCON MS	WSC	NOF	PHD
			(mm)	(mm)	(mm)	(mm)	(mm)	(mm)	
E1192.1/2N03	2.1/2	11	75.180	160.0	40	50.00	39.00	6	72.50
E1192.1/2N09	2.1/2	11	75.180	160.0	40	50.00	39.00	6	72.50
E1192.3/4N03	2.3/4	11	81.530	160.0	40	50.00	39.00	8	79.00
E1192.3/4N09	2.3/4	11	81.530	160.0	40	50.00	39.00	8	79.00
E1193N03	3"	11	87.880	160.0	40	50.00	39.00	8	85.50
E1193N09	3"	11	87.880	160.0	40	50.00	39.00	8	85.50

E500



Straight Flute Hand Taps, Metric, ISO Standard

A versatile tool, suitable for hand and machine tapping, with a straight flute design for both through and blind holes. As a hand tap set of three NO6 or two NO7 with different chamfer length, each producing a full thread. Or as a set NO8 with three serial taps to be used in sequence to create the full thread.

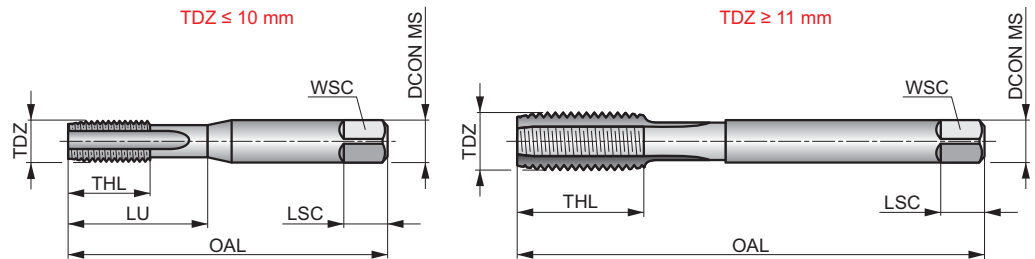

	ISO 529	6H
	1.5xD	HSS
	R	Bright

Workpiece material group suitability and starting values for cutting speed (m/min).

P1.1 ■7	P1.2 ■7	P1.3 ■8	P2.1 ■6	P2.2 ■5	P2.3 ▣4	P3.1 ■4	P3.2 ▣4	P4.1 ▣3	P4.2 ▣2	K1.1 ▣12	K1.2 ▣9	K1.3 ▣7	K2.1 ▣12
K2.2 ▣10	K3.1 ▣11	K3.2 ▣8	K4.1 ▣10	K4.2 ▣8	K5.1 ▣11	K5.2 ▣9	N1.3 ▣8	N2.1 ▣11	N2.2 ▣10	N2.3 ▣7	N3.1 ▣17	N3.2 ▣10	N3.3 ▣5
N4.2 ▣5	N4.3 ▣3												

Products from this series are also available in sets with drills or dies. Please see L115, L000 or L120.

Product	TDZ	TP	OAL	THL	DCON MS	WSC	LSC	NOF	PHD	LU
		(mm)	(mm)	(mm)	(mm)	(mm)	(mm)		(mm)	(mm)
E500M1N01 ¹⁾	1	0.25	38.0	4.5	2.50	2.00	4	2	0.75	4.50
E500M1N02 ¹⁾	1	0.25	38.0	4.5	2.50	2.00	4	2	0.75	4.50
E500M1N03 ¹⁾	1	0.25	38.0	4.5	2.50	2.00	4	2	0.75	4.50
E500M1.2N01 ¹⁾	1.2	0.25	38.0	4.5	2.50	2.00	4	2	0.95	4.50
E500M1.2N02 ¹⁾	1.2	0.25	38.0	4.5	2.50	2.00	4	2	0.95	4.50
E500M1.2N03 ¹⁾	1.2	0.25	38.0	4.5	2.50	2.00	4	2	0.95	4.50
E500M1.4N01 ¹⁾	1.4	0.30	40.0	6	2.50	2.00	4	2	1.10	6.00
E500M1.4N02 ¹⁾	1.4	0.30	40.0	6	2.50	2.00	4	2	1.10	6.00
E500M1.4N03 ¹⁾	1.4	0.30	40.0	6	2.50	2.00	4	2	1.10	6.00
E500M1.6N01	1.6	0.35	41.0	8	2.50	2.00	4	2	1.25	8.00
E500M1.6N02	1.6	0.35	41.0	8	2.50	2.00	4	2	1.25	8.00
E500M1.6N03	1.6	0.35	41.0	8	2.50	2.00	4	2	1.25	8.00
E500M1.6N06	1.6	0.35	41.0	8	2.50	2.00	4	2	1.25	8.00
E500M1.7N01	1.7	0.35	41.0	8	2.50	2.00	4	2	1.35	8.00
E500M1.7N02	1.7	0.35	41.0	8	2.50	2.00	4	2	1.35	8.00
E500M1.7N03	1.7	0.35	41.0	8	2.50	2.00	4	2	1.35	8.00
E500M1.7N06	1.7	0.35	41.0	8	2.50	2.00	4	2	1.35	8.00
E500M1.7N08	1.7	0.35	41.0	8	2.50	2.00	4	2	1.35	8.00
E500M1.8N01	1.8	0.35	41.0	8	2.50	2.00	4	2	1.45	8.00
E500M1.8N02	1.8	0.35	41.0	8	2.50	2.00	4	2	1.45	8.00
E500M1.8N03	1.8	0.35	41.0	8	2.50	2.00	4	2	1.45	8.00
E500M2N01	2	0.40	41.0	8	2.50	2.00	4	3	1.60	8.00
E500M2N02	2	0.40	41.0	8	2.50	2.00	4	3	1.60	8.00
E500M2N03	2	0.40	41.0	8	2.50	2.00	4	3	1.60	8.00
E500M2N06	2	0.40	41.0	8	2.50	2.00	4	3	1.60	8.00
E500M2N08	2	0.40	41.0	8	2.50	2.00	4	3	1.60	8.00
E500M2X.45N01	2	0.45	41.0	8	2.50	2.00	4	3	1.55	8.00



Product	TDZ	TP	OAL	THL	DCON MS	WSC	LSC	NOF	PHD	LU
		(mm)	(mm)	(mm)	(mm)	(mm)	(mm)	(mm)	(mm)	(mm)
E500M2X.45N02	2	0.45	41.0	8	2.50	2.00	4	3	1.55	8.00
E500M2X.45N03	2	0.45	41.0	8	2.50	2.00	4	3	1.55	8.00
E500M2.2N01	2.2	0.45	44.5	9.5	2.80	2.24	5	3	1.75	9.50
E500M2.2N02	2.2	0.45	44.5	9.5	2.80	2.24	5	3	1.75	9.50
E500M2.2N03	2.2	0.45	44.5	9.5	2.80	2.24	5	3	1.75	9.50
E500M2.3N01	2.3	0.45	44.5	9.5	2.80	2.24	5	3	1.85	9.50
E500M2.3N02	2.3	0.45	44.5	9.5	2.80	2.24	5	3	1.85	9.50
E500M2.3N03	2.3	0.45	44.5	9.5	2.80	2.24	5	3	1.85	9.50
E500M2.5N01	2.5	0.45	44.5	9.5	2.80	2.24	5	3	2.05	9.50
E500M2.5N02	2.5	0.45	44.5	9.5	2.80	2.24	5	3	2.05	9.50
E500M2.5N03	2.5	0.45	44.5	9.5	2.80	2.24	5	3	2.05	9.50
E500M2.5N06	2.5	0.45	44.5	9.5	2.80	2.24	5	3	2.05	9.50
E500M2.5N08	2.5	0.45	44.5	9.5	2.80	2.24	5	3	2.05	9.50
E500M2.6N01	2.6	0.45	44.5	9.5	2.80	2.24	5	3	2.15	9.50
E500M2.6N02	2.6	0.45	44.5	9.5	2.80	2.24	5	3	2.15	9.50
E500M2.6N03	2.6	0.45	44.5	9.5	2.80	2.24	5	3	2.15	9.50
E500M3N01	3	0.50	48.0	12.5	3.15	2.50	5	3	2.50	12.50
E500M3N02	3	0.50	48.0	12.5	3.15	2.50	5	3	2.50	12.50
E500M3N03	3	0.50	48.0	12.5	3.15	2.50	5	3	2.50	12.50
E500M3N06	3	0.50	48.0	12.5	3.15	2.50	5	3	2.50	12.50
E500M3N07	3	0.50	48.0	12.5	3.15	2.50	5	3	2.50	12.50
E500M3N08	3	0.50	48.0	12.5	3.15	2.50	5	3	2.50	12.50
E500M3X.6N01	3	0.60	48.0	12.5	3.15	2.50	5	3	2.40	12.50
E500M3X.6N02	3	0.60	48.0	12.5	3.15	2.50	5	3	2.40	12.50
E500M3X.6N03	3	0.60	48.0	12.5	3.15	2.50	5	3	2.40	12.50
E500M3.5N01	3.5	0.60	50.0	14	3.55	2.80	5	3	2.90	14.00
E500M3.5N02	3.5	0.60	50.0	14	3.55	2.80	5	3	2.90	14.00
E500M3.5N03	3.5	0.60	50.0	14	3.55	2.80	5	3	2.90	14.00
E500M3.5N06	3.5	0.60	50.0	14	3.55	2.80	5	3	2.90	14.00
E500M4N01	4	0.70	53.0	14	4.00	3.15	6	3	3.30	14.00
E500M4N02	4	0.70	53.0	14	4.00	3.15	6	3	3.30	14.00
E500M4N03	4	0.70	53.0	14	4.00	3.15	6	3	3.30	14.00
E500M4N06	4	0.70	53.0	14	4.00	3.15	6	3	3.30	14.00
E500M4N07	4	0.70	53.0	14	4.00	3.15	6	3	3.30	14.00
E500M4N08	4	0.70	53.0	14	4.00	3.15	6	3	3.30	14.00
E500M4X.75N01	4	0.75	53.0	14	4.00	3.15	6	3	3.25	14.00
E500M4X.75N02	4	0.75	53.0	14	4.00	3.15	6	3	3.25	14.00
E500M4X.75N03	4	0.75	53.0	14	4.00	3.15	6	3	3.25	14.00
E500M4.5N01	4.5	0.75	53.0	9.5	4.50	3.55	6	3	3.80	18.00
E500M4.5N02	4.5	0.75	53.0	9.5	4.50	3.55	6	3	3.80	18.00
E500M4.5N03	4.5	0.75	53.0	9.5	4.50	3.55	6	3	3.80	18.00
E500M4.5N06	4.5	0.75	53.0	9.5	4.50	3.55	6	3	3.80	18.00
E500M5N01	5	0.80	58.0	11	5.00	4.00	7	3	4.20	22.00
E500M5N02	5	0.80	58.0	11	5.00	4.00	7	3	4.20	22.00
E500M5N03	5	0.80	58.0	11	5.00	4.00	7	3	4.20	22.00
E500M5N06	5	0.80	58.0	11	5.00	4.00	7	3	4.20	22.00
E500M5N07	5	0.80	58.0	11	5.00	4.00	7	3	4.20	22.00
E500M5N08	5	0.80	58.0	11	5.00	4.00	7	3	4.20	22.00
E500M5X.9N01	5	0.90	58.0	11	5.00	4.00	7	3	4.10	22.00
E500M5X.9N02	5	0.90	58.0	11	5.00	4.00	7	3	4.10	22.00
E500M5X.9N03	5	0.90	58.0	11	5.00	4.00	7	3	4.10	22.00
E500M5.5X.9N01	5.5	0.90	62.0	12	5.60	4.50	7	3	4.60	21.00
E500M5.5X.9N02	5.5	0.90	62.0	12	5.60	4.50	7	3	4.60	21.00
E500M5.5X.9N03	5.5	0.90	62.0	12	5.60	4.50	7	3	4.60	21.00
E500M6N01	6	1.00	66.0	13	6.30	5.00	8	3	5.00	26.00
E500M6N02	6	1.00	66.0	13	6.30	5.00	8	3	5.00	26.00
E500M6N03	6	1.00	66.0	13	6.30	5.00	8	3	5.00	26.00
E500M6N06	6	1.00	66.0	13	6.30	5.00	8	3	5.00	26.00
E500M6N07	6	1.00	66.0	13	6.30	5.00	8	3	5.00	26.00
E500M6N08	6	1.00	66.0	13	6.30	5.00	8	3	5.00	26.00
E500M7N01	7	1.00	66.0	13	7.10	5.60	8	3	6.00	26.00
E500M7N02	7	1.00	66.0	13	7.10	5.60	8	3	6.00	26.00



Product	TDZ	TP	OAL	THL	DCON MS	WSC	LSC	NOF	PHD	LU
		(mm)	(mm)	(mm)	(mm)	(mm)	(mm)	(mm)	(mm)	(mm)
E500M7N03	7	1.00	66.0	13	7.10	5.60	8	3	6.00	26.00
E500M7N06	7	1.00	66.0	13	7.10	5.60	8	3	6.00	26.00
E500M8N01	8	1.25	72.0	16	8.00	6.30	9	3	6.80	29.00
E500M8N02	8	1.25	72.0	16	8.00	6.30	9	3	6.80	29.00
E500M8N03	8	1.25	72.0	16	8.00	6.30	9	3	6.80	29.00
E500M8N06	8	1.25	72.0	16	8.00	6.30	9	3	6.80	29.00
E500M8N07	8	1.25	72.0	16	8.00	6.30	9	3	6.80	29.00
E500M8N08	8	1.25	72.0	16	8.00	6.30	9	3	6.80	29.00
E500M9N01	9	1.25	72.0	16	9.00	7.10	10	3	7.80	29.00
E500M9N02	9	1.25	72.0	16	9.00	7.10	10	3	7.80	29.00
E500M9N03	9	1.25	72.0	16	9.00	7.10	10	3	7.80	29.00
E500M9N06	9	1.25	72.0	16	9.00	7.10	10	3	7.80	29.00
E500M10N01	10	1.50	80.0	18	10.00	8.00	11	3	8.50	34.00
E500M10N02	10	1.50	80.0	18	10.00	8.00	11	3	8.50	34.00
E500M10N03	10	1.50	80.0	18	10.00	8.00	11	3	8.50	34.00
E500M10N06	10	1.50	80.0	18	10.00	8.00	11	3	8.50	34.00
E500M10N07	10	1.50	80.0	18	10.00	8.00	11	3	8.50	34.00
E500M10N08	10	1.50	80.0	18	10.00	8.00	11	3	8.50	34.00
E500M11N01	11	1.50	85.0	19	8.00	6.30	9	3	9.50	–
E500M11N02	11	1.50	85.0	19	8.00	6.30	9	3	9.50	–
E500M11N03	11	1.50	85.0	19	8.00	6.30	9	3	9.50	–
E500M11N06	11	1.50	85.0	19	8.00	6.30	9	3	9.50	–
E500M12N01	12	1.75	89.0	22	9.00	7.10	10	3	10.30	–
E500M12N02	12	1.75	89.0	22	9.00	7.10	10	3	10.30	–
E500M12N03	12	1.75	89.0	22	9.00	7.10	10	3	10.30	–
E500M12N06	12	1.75	89.0	22	9.00	7.10	10	3	10.30	–
E500M12N07	12	1.75	89.0	22	9.00	7.10	10	3	10.30	–
E500M12N08	12	1.75	89.0	22	9.00	7.10	10	3	10.30	–
E500M14N01	14	2.00	95.0	24	11.20	9.00	12	4	12.00	–
E500M14N02	14	2.00	95.0	24	11.20	9.00	12	4	12.00	–
E500M14N03	14	2.00	95.0	24	11.20	9.00	12	4	12.00	–
E500M14N06	14	2.00	95.0	24	11.20	9.00	12	4	12.00	–
E500M14N07	14	2.00	95.0	24	11.20	9.00	12	4	12.00	–
E500M14N08	14	2.00	95.0	24	11.20	9.00	12	4	12.00	–
E500M16N01	16	2.00	102.0	24	12.50	10.00	13	4	14.00	–
E500M16N02	16	2.00	102.0	24	12.50	10.00	13	4	14.00	–
E500M16N03	16	2.00	102.0	24	12.50	10.00	13	4	14.00	–
E500M16N06	16	2.00	102.0	24	12.50	10.00	13	4	14.00	–
E500M16N07	16	2.00	102.0	24	12.50	10.00	13	4	14.00	–
E500M16N08	16	2.00	102.0	24	12.50	10.00	13	4	14.00	–
E500M18N01	18	2.50	112.0	29	14.00	11.20	14	4	15.50	–
E500M18N02	18	2.50	112.0	29	14.00	11.20	14	4	15.50	–
E500M18N03	18	2.50	112.0	29	14.00	11.20	14	4	15.50	–
E500M18N06	18	2.50	112.0	29	14.00	11.20	14	4	15.50	–
E500M20N01	20	2.50	112.0	29	14.00	11.20	14	4	17.50	–
E500M20N02	20	2.50	112.0	29	14.00	11.20	14	4	17.50	–
E500M20N03	20	2.50	112.0	29	14.00	11.20	14	4	17.50	–
E500M20N06	20	2.50	112.0	29	14.00	11.20	14	4	17.50	–
E500M20N07	20	2.50	112.0	29	14.00	11.20	14	4	17.50	–
E500M20N08	20	2.50	112.0	29	14.00	11.20	14	4	17.50	–
E500M22N01	22	2.50	118.0	29	16.00	12.50	16	4	19.50	–
E500M22N02	22	2.50	118.0	29	16.00	12.50	16	4	19.50	–
E500M22N03	22	2.50	118.0	29	16.00	12.50	16	4	19.50	–
E500M22N06	22	2.50	118.0	29	16.00	12.50	16	4	19.50	–
E500M24N01	24	3.00	130.0	35	18.00	14.00	18	4	21.00	–
E500M24N02	24	3.00	130.0	35	18.00	14.00	18	4	21.00	–
E500M24N03	24	3.00	130.0	35	18.00	14.00	18	4	21.00	–
E500M24N06	24	3.00	130.0	35	18.00	14.00	18	4	21.00	–
E500M24N07	24	3.00	130.0	35	18.00	14.00	18	4	21.00	–
E500M27N01	27	3.00	135.0	35	20.00	16.00	20	4	24.00	–
E500M27N02	27	3.00	135.0	35	20.00	16.00	20	4	24.00	–
E500M27N03	27	3.00	135.0	35	20.00	16.00	20	4	24.00	–



Product	TDZ	TP	OAL	THL	DCON MS	WSC	LSC	NOF	PHD	LU
		(mm)	(mm)	(mm)	(mm)	(mm)	(mm)	(mm)	(mm)	(mm)
E500M30N01	30	3.50	138.0	41	20.00	16.00	20	4	26.50	—
E500M30N02	30	3.50	138.0	41	20.00	16.00	20	4	26.50	—
E500M30N03	30	3.50	138.0	41	20.00	16.00	20	4	26.50	—
E500M33N01	33	3.50	151.0	41	22.40	18.00	22	4	29.50	—
E500M33N02	33	3.50	151.0	41	22.40	18.00	22	4	29.50	—
E500M33N03	33	3.50	151.0	41	22.40	18.00	22	4	29.50	—
E500M36N01	36	4.00	162.0	47	25.00	20.00	24	4	32.00	—
E500M36N02	36	4.00	162.0	47	25.00	20.00	24	4	32.00	—
E500M36N03	36	4.00	162.0	47	25.00	20.00	24	4	32.00	—
E500M39N01	39	4.00	170.0	47	28.00	22.40	26	4	35.00	—
E500M39N02	39	4.00	170.0	47	28.00	22.40	26	4	35.00	—
E500M39N03	39	4.00	170.0	47	28.00	22.40	26	4	35.00	—
E500M42N01	42	4.50	170.0	53	28.00	22.40	26	6	37.50	—
E500M42N02	42	4.50	170.0	53	28.00	22.40	26	6	37.50	—
E500M42N03	42	4.50	170.0	53	28.00	22.40	26	6	37.50	—
E500M45N01	45	4.50	187.0	54	31.50	25.00	28	6	40.50	—
E500M45N02	45	4.50	187.0	54	31.50	25.00	28	6	40.50	—
E500M45N03	45	4.50	187.0	54	31.50	25.00	28	6	40.50	—
E500M48N01	48	5.00	187.0	60	31.50	25.00	28	6	43.00	—
E500M48N02	48	5.00	187.0	60	31.50	25.00	28	6	43.00	—
E500M48N03	48	5.00	187.0	60	31.50	25.00	28	6	43.00	—
E500M52N03	52	5.00	200.0	60	35.50	28.00	31	6	47.00	—
E500M56N03	56	5.50	200.0	60	35.50	28.00	31	6	50.50	—

¹⁾ Supplied in 5H tolerance.

E513



HSS Straight Flute Hand Tap, Metric Fine, ISO Standard

A versatile tool, suitable for hand and machine tapping, with a straight flute design for both through and blind holes. Available with taper lead NO1 for short through holes, plug lead NO2 for deeper through holes or bottoming lead NO3 for blind holes. Also, as a set NO7 with a plug lead and bottoming lead tap.

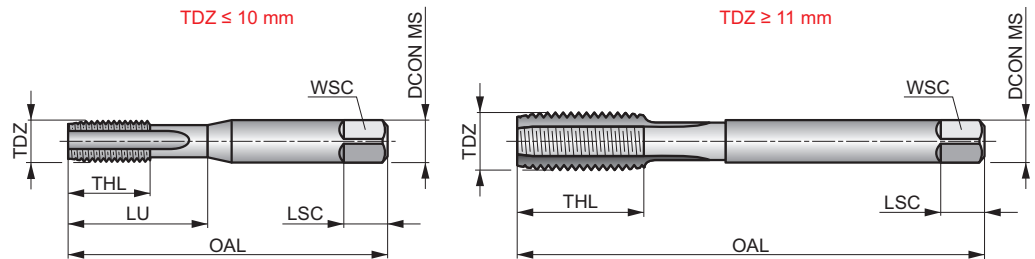

	ISO 529	6H
	1.5xD	HSS
	R	Bright

Workpiece material group suitability and starting values for cutting speed (m/min).

P1.1 ■7	P1.2 ■7	P1.3 ■8	P2.1 ■6	P2.2 ■5	P2.3 ▣4	P3.1 ■4	P3.2 ▣4	P4.1 ▣3	K1.1 ▣12	K1.2 ▣9	K1.3 ▣7	K2.1 ▣12	K2.2 ▣10
K3.1 ▣11	K3.2 ▣8	K4.1 ▣10	K4.2 ▣8	K5.1 ▣11	K5.2 ▣9	N1.3 ▣8	N2.1 ▣11	N2.2 ▣10	N2.3 ▣7	N3.1 ■17	N3.2 ■10	N3.3 ▣5	N4.2 ▣5
N4.3 ▣3													

Product	TDZ	TP	OAL	THL	DCON MS	WSC	LSC	NOF	PHD	LU
	(mm)	(mm)	(mm)	(mm)	(mm)	(mm)	(mm)		(mm)	(mm)
E513M3X.35N01	3	0.35	48.0	12.5	3.15	2.50	5	3	2.65	12.50
E513M3X.35N02	3	0.35	48.0	12.5	3.15	2.50	5	3	2.65	12.50
E513M3X.35N03	3	0.35	48.0	12.5	3.15	2.50	5	3	2.65	12.50
E513M3.5X.35N03	3.5	0.35	48.0	12.5	3.15	2.50	5	3	3.20	12.50
E513M4X.5N01	4	0.50	53.0	14	4.00	3.15	6	3	3.50	14.00
E513M4X.5N02	4	0.50	53.0	14	4.00	3.15	6	3	3.50	14.00
E513M4X.5N03	4	0.50	53.0	14	4.00	3.15	6	3	3.50	14.00
E513M4X.5N07	4	0.50	53.0	14	4.00	3.15	6	3	3.50	14.00
E513M5X.5N01	5	0.50	58.0	11	5.00	4.00	7	3	4.50	22.00
E513M5X.5N02	5	0.50	58.0	11	5.00	4.00	7	3	4.50	22.00
E513M5X.5N03	5	0.50	58.0	11	5.00	4.00	7	3	4.50	22.00
E513M5X.5N07	5	0.50	58.0	11	5.00	4.00	7	3	4.50	22.00
E513M5X.75N01	5	0.75	58.0	11	5.00	4.00	7	3	4.30	22.00
E513M5X.75N02	5	0.75	58.0	11	5.00	4.00	7	3	4.30	22.00
E513M5X.75N03	5	0.75	58.0	11	5.00	4.00	7	3	4.30	22.00
E513M6X.5N01	6	0.50	66.0	13	6.30	5.00	8	3	5.50	26.00
E513M6X.5N02	6	0.50	66.0	13	6.30	5.00	8	3	5.50	26.00
E513M6X.5N03	6	0.50	66.0	13	6.30	5.00	8	3	5.50	26.00
E513M6X.75N01	6	0.75	66.0	13	6.30	5.00	8	3	5.30	26.00
E513M6X.75N02	6	0.75	66.0	13	6.30	5.00	8	3	5.30	26.00
E513M6X.75N03	6	0.75	66.0	13	6.30	5.00	8	3	5.30	26.00
E513M6X.75N07	6	0.75	66.0	13	6.30	5.00	8	3	5.30	26.00
E513M7X.75N01	7	0.75	66.0	13	7.10	5.60	8	3	6.30	26.00
E513M7X.75N02	7	0.75	66.0	13	7.10	5.60	8	3	6.30	26.00
E513M7X.75N03	7	0.75	66.0	13	7.10	5.60	8	3	6.30	26.00
E513M8X.5N01	8	0.50	72.0	16	8.00	6.30	9	3	7.50	29.00
E513M8X.5N02	8	0.50	72.0	16	8.00	6.30	9	3	7.50	29.00
E513M8X.5N03	8	0.50	72.0	16	8.00	6.30	9	3	7.50	29.00



Product	TDZ	TP	OAL	THL	DCON MS	WSC	LSC	NOF	PHD	LU
		(mm)	(mm)	(mm)	(mm)	(mm)	(mm)	(mm)	(mm)	(mm)
E513M8X.75N01	8	0.75	72.0	16	8.00	6.30	9	3	7.30	29.00
E513M8X.75N02	8	0.75	72.0	16	8.00	6.30	9	3	7.30	29.00
E513M8X.75N03	8	0.75	72.0	16	8.00	6.30	9	3	7.30	29.00
E513M8X.75N07	8	0.75	72.0	16	8.00	6.30	9	3	7.30	29.00
E513M8X1.0N01	8	1.00	72.0	16	8.00	6.30	9	3	7.00	29.00
E513M8X1.0N02	8	1.00	72.0	16	8.00	6.30	9	3	7.00	29.00
E513M8X1.0N03	8	1.00	72.0	16	8.00	6.30	9	3	7.00	29.00
E513M8X1.0N07	8	1.00	72.0	16	8.00	6.30	9	3	7.00	29.00
E513M9X.75N03	9	0.75	72.0	16	9.00	7.10	10	3	8.30	29.00
E513M9X1.0N01	9	1.00	72.0	16	9.00	7.10	10	3	8.00	29.00
E513M9X1.0N02	9	1.00	72.0	16	9.00	7.10	10	3	8.00	29.00
E513M9X1.0N03	9	1.00	72.0	16	9.00	7.10	10	3	8.00	29.00
E513M10X.5N03	10	0.50	80.0	18	10.00	8.00	11	3	9.50	34.00
E513M10X.75N01	10	0.75	80.0	18	10.00	8.00	11	3	9.30	34.00
E513M10X.75N02	10	0.75	80.0	18	10.00	8.00	11	3	9.30	34.00
E513M10X.75N03	10	0.75	80.0	18	10.00	8.00	11	3	9.30	34.00
E513M10X1.0N01	10	1.00	80.0	18	10.00	8.00	11	3	9.00	34.00
E513M10X1.0N02	10	1.00	80.0	18	10.00	8.00	11	3	9.00	34.00
E513M10X1.0N03	10	1.00	80.0	18	10.00	8.00	11	3	9.00	34.00
E513M10X1.0N06	10	1.00	80.0	18	10.00	8.00	11	3	9.00	34.00
E513M10X1.0N07	10	1.00	80.0	18	10.00	8.00	11	3	9.00	34.00
E513M10X1.25N01	10	1.25	80.0	18	10.00	8.00	11	3	8.80	34.00
E513M10X1.25N02	10	1.25	80.0	18	10.00	8.00	11	3	8.80	34.00
E513M10X1.25N03	10	1.25	80.0	18	10.00	8.00	11	3	8.80	34.00
E513M10X1.25N06	10	1.25	80.0	18	10.00	8.00	11	3	8.80	34.00
E513M10X1.25N07	10	1.25	80.0	18	10.00	8.00	11	3	8.80	34.00
E513M11X.75N01	11	0.75	85.0	19	8.00	6.30	9	3	10.30	—
E513M11X.75N02	11	0.75	85.0	19	8.00	6.30	9	3	10.30	—
E513M11X.75N03	11	0.75	85.0	19	8.00	6.30	9	3	10.30	—
E513M11X1.0N01	11	1.00	85.0	19	8.00	6.30	9	3	10.00	—
E513M11X1.0N02	11	1.00	85.0	19	8.00	6.30	9	3	10.00	—
E513M11X1.0N03	11	1.00	85.0	19	8.00	6.30	9	3	10.00	—
E513M11X1.25N03	11	1.25	85.0	19	8.00	6.30	9	3	9.80	—
E513M12X.75N03	12	0.75	89.0	22	9.00	7.10	10	3	11.30	—
E513M12X1.0N01	12	1.00	89.0	22	9.00	7.10	10	3	11.00	—
E513M12X1.0N02	12	1.00	89.0	22	9.00	7.10	10	3	11.00	—
E513M12X1.0N03	12	1.00	89.0	22	9.00	7.10	10	3	11.00	—
E513M12X1.0N07	12	1.00	89.0	22	9.00	7.10	10	3	11.00	—
E513M12X1.25N01	12	1.25	89.0	22	9.00	7.10	10	3	10.80	—
E513M12X1.25N02	12	1.25	89.0	22	9.00	7.10	10	3	10.80	—
E513M12X1.25N03	12	1.25	89.0	22	9.00	7.10	10	3	10.80	—
E513M12X1.25N06	12	1.25	89.0	22	9.00	7.10	10	3	10.80	—
E513M12X1.25N07	12	1.25	89.0	22	9.00	7.10	10	3	10.80	—
E513M12X1.5N01	12	1.50	89.0	22	9.00	7.10	10	3	10.50	—
E513M12X1.5N02	12	1.50	89.0	22	9.00	7.10	10	3	10.50	—
E513M12X1.5N03	12	1.50	89.0	22	9.00	7.10	10	3	10.50	—
E513M12X1.5N06	12	1.50	89.0	22	9.00	7.10	10	3	10.50	—
E513M12X1.5N07	12	1.50	89.0	22	9.00	7.10	10	3	10.50	—
E513M13X1.5N03	13	1.50	89.0	22	9.00	7.10	10	3	11.50	—
E513M14X1.0N01	14	1.00	95.0	24	11.20	9.00	12	4	13.00	—
E513M14X1.0N02	14	1.00	95.0	24	11.20	9.00	12	4	13.00	—
E513M14X1.0N03	14	1.00	95.0	24	11.20	9.00	12	4	13.00	—
E513M14X1.0N07	14	1.00	95.0	24	11.20	9.00	12	4	13.00	—
E513M14X1.25N01	14	1.25	95.0	24	11.20	9.00	12	4	12.80	—
E513M14X1.25N02	14	1.25	95.0	24	11.20	9.00	12	4	12.80	—
E513M14X1.25N03	14	1.25	95.0	24	11.20	9.00	12	4	12.80	—
E513M14X1.25N06	14	1.25	95.0	24	11.20	9.00	12	4	12.80	—
E513M14X1.5N01	14	1.50	95.0	24	11.20	9.00	12	4	12.50	—
E513M14X1.5N02	14	1.50	95.0	24	11.20	9.00	12	4	12.50	—
E513M14X1.5N03	14	1.50	95.0	24	11.20	9.00	12	4	12.50	—
E513M14X1.5N06	14	1.50	95.0	24	11.20	9.00	12	4	12.50	—
E513M14X1.5N07	14	1.50	95.0	24	11.20	9.00	12	4	12.50	—



Product	TDZ	TP	OAL	THL	DCON MS	WSC	LSC	NOF	PHD	LU
		(mm)	(mm)	(mm)	(mm)	(mm)	(mm)	(mm)	(mm)	(mm)
E513M15X1.5N02	15	1.50	95.0	24	11.20	9.00	12	4	13.50	–
E513M15X1.5N03	15	1.50	95.0	24	11.20	9.00	12	4	13.50	–
E513M16X1.0N01	16	1.00	102.0	24	12.50	10.00	13	4	15.00	–
E513M16X1.0N02	16	1.00	102.0	24	12.50	10.00	13	4	15.00	–
E513M16X1.0N03	16	1.00	102.0	24	12.50	10.00	13	4	15.00	–
E513M16X1.0N07	16	1.00	102.0	24	12.50	10.00	13	4	15.00	–
E513M16X1.25N03	16	1.25	102.0	24	12.50	10.00	13	4	14.80	–
E513M16X1.5N01	16	1.50	102.0	24	12.50	10.00	13	4	14.50	–
E513M16X1.5N02	16	1.50	102.0	24	12.50	10.00	13	4	14.50	–
E513M16X1.5N03	16	1.50	102.0	24	12.50	10.00	13	4	14.50	–
E513M16X1.5N06	16	1.50	102.0	24	12.50	10.00	13	4	14.50	–
E513M16X1.5N07	16	1.50	102.0	24	12.50	10.00	13	4	14.50	–
E513M18X1.0N01	18	1.00	112.0	29	14.00	11.20	14	4	17.00	–
E513M18X1.0N02	18	1.00	112.0	29	14.00	11.20	14	4	17.00	–
E513M18X1.0N03	18	1.00	112.0	29	14.00	11.20	14	4	17.00	–
E513M18X1.0N07	18	1.00	112.0	29	14.00	11.20	14	4	17.00	–
E513M18X1.5N01	18	1.50	112.0	29	14.00	11.20	14	4	16.50	–
E513M18X1.5N02	18	1.50	112.0	29	14.00	11.20	14	4	16.50	–
E513M18X1.5N03	18	1.50	112.0	29	14.00	11.20	14	4	16.50	–
E513M18X1.5N06	18	1.50	112.0	29	14.00	11.20	14	4	16.50	–
E513M18X1.5N07	18	1.50	112.0	29	14.00	11.20	14	4	16.50	–
E513M18X2.0N01	18	2.00	112.0	29	14.00	11.20	14	4	16.00	–
E513M18X2.0N02	18	2.00	112.0	29	14.00	11.20	14	4	16.00	–
E513M18X2.0N03	18	2.00	112.0	29	14.00	11.20	14	4	16.00	–
E513M18X2.0N07	18	2.00	112.0	29	14.00	11.20	14	4	16.00	–
E513M20X1.0N01	20	1.00	112.0	29	14.00	11.20	14	4	19.00	–
E513M20X1.0N02	20	1.00	112.0	29	14.00	11.20	14	4	19.00	–
E513M20X1.0N03	20	1.00	112.0	29	14.00	11.20	14	4	19.00	–
E513M20X1.0N07	20	1.00	112.0	29	14.00	11.20	14	4	19.00	–
E513M20X1.5N01	20	1.50	112.0	29	14.00	11.20	14	4	18.50	–
E513M20X1.5N02	20	1.50	112.0	29	14.00	11.20	14	4	18.50	–
E513M20X1.5N03	20	1.50	112.0	29	14.00	11.20	14	4	18.50	–
E513M20X1.5N06	20	1.50	112.0	29	14.00	11.20	14	4	18.50	–
E513M20X1.5N07	20	1.50	112.0	29	14.00	11.20	14	4	18.50	–
E513M20X2.0N01	20	2.00	112.0	29	14.00	11.20	14	4	18.00	–
E513M20X2.0N02	20	2.00	112.0	29	14.00	11.20	14	4	18.00	–
E513M20X2.0N03	20	2.00	112.0	29	14.00	11.20	14	4	18.00	–
E513M20X2.0N07	20	2.00	112.0	29	14.00	11.20	14	4	18.00	–
E513M22X1.0N02	22	1.00	118.0	29	16.00	12.50	16	4	21.00	–
E513M22X1.0N03	22	1.00	118.0	29	16.00	12.50	16	4	21.00	–
E513M22X1.0N07	22	1.00	118.0	29	16.00	12.50	16	4	21.00	–
E513M22X1.5N01	22	1.50	118.0	29	16.00	12.50	16	4	20.50	–
E513M22X1.5N02	22	1.50	118.0	29	16.00	12.50	16	4	20.50	–
E513M22X1.5N03	22	1.50	118.0	29	16.00	12.50	16	4	20.50	–
E513M22X1.5N07	22	1.50	118.0	29	16.00	12.50	16	4	20.50	–
E513M22X2.0N01	22	2.00	118.0	29	16.00	12.50	16	4	20.00	–
E513M22X2.0N02	22	2.00	118.0	29	16.00	12.50	16	4	20.00	–
E513M22X2.0N03	22	2.00	118.0	29	16.00	12.50	16	4	20.00	–
E513M22X2.0N07	22	2.00	118.0	29	16.00	12.50	16	4	20.00	–
E513M24X1.0N02	24	1.00	130.0	35	18.00	14.00	18	4	23.00	–
E513M24X1.0N03	24	1.00	130.0	35	18.00	14.00	18	4	23.00	–
E513M24X1.5N01	24	1.50	130.0	35	18.00	14.00	18	4	22.50	–
E513M24X1.5N02	24	1.50	130.0	35	18.00	14.00	18	4	22.50	–
E513M24X1.5N03	24	1.50	130.0	35	18.00	14.00	18	4	22.50	–
E513M24X1.5N07	24	1.50	130.0	35	18.00	14.00	18	4	22.50	–
E513M24X2.0N01	24	2.00	130.0	35	18.00	14.00	18	4	22.00	–
E513M24X2.0N02	24	2.00	130.0	35	18.00	14.00	18	4	22.00	–
E513M24X2.0N03	24	2.00	130.0	35	18.00	14.00	18	4	22.00	–
E513M24X2.0N07	24	2.00	130.0	35	18.00	14.00	18	4	22.00	–
E513M25X1.5N01	25	1.50	130.0	35	18.00	14.00	18	4	23.50	–
E513M25X1.5N02	25	1.50	130.0	35	18.00	14.00	18	4	23.50	–
E513M25X1.5N03	25	1.50	130.0	35	18.00	14.00	18	4	23.50	–



Product	TDZ	TP	OAL	THL	DCON MS	WSC	LSC	NOF	PHD	LU
		(mm)	(mm)	(mm)	(mm)	(mm)	(mm)	(mm)	(mm)	(mm)
E513M25X1.5N06	25	1.50	130.0	35	18.00	14.00	18	4	23.50	—
E513M25X1.5N07	25	1.50	130.0	35	18.00	14.00	18	4	23.50	—
E513M26X1.5N02	26	1.50	130.0	35	18.00	14.00	18	4	24.50	—
E513M26X1.5N03	26	1.50	130.0	35	18.00	14.00	18	4	24.50	—
E513M27X1.5N02	27	1.50	135.0	35	20.00	16.00	20	4	25.50	—
E513M27X1.5N03	27	1.50	135.0	35	20.00	16.00	20	4	25.50	—
E513M27X2.0N03	27	2.00	135.0	35	20.00	16.00	20	4	25.00	—
E513M28X1.5N02	28	1.50	138.0	35	20.00	16.00	20	4	26.50	—
E513M28X1.5N03	28	1.50	138.0	35	20.00	16.00	20	4	26.50	—
E513M30X1.5N02	30	1.50	138.0	41	20.00	16.00	20	4	28.50	—
E513M30X1.5N03	30	1.50	138.0	41	20.00	16.00	20	4	28.50	—
E513M30X2.0N02	30	2.00	138.0	41	20.00	16.00	20	4	28.00	—
E513M30X2.0N03	30	2.00	138.0	41	20.00	16.00	20	4	28.00	—
E513M32X1.5N01	32	1.50	151.0	41	22.40	18.00	22	4	30.50	—
E513M32X1.5N02	32	1.50	151.0	41	22.40	18.00	22	4	30.50	—
E513M32X1.5N03	32	1.50	151.0	41	22.40	18.00	22	4	30.50	—
E513M33X2.0N02	33	2.00	151.0	41	22.40	18.00	22	4	31.00	—
E513M33X2.0N03	33	2.00	151.0	41	22.40	18.00	22	4	31.00	—
E513M35X1.5N02	35	1.50	162.0	47	25.00	20.00	24	4	33.50	—
E513M35X1.5N03	35	1.50	162.0	47	25.00	20.00	24	4	33.50	—
E513M36X1.5N03	36	1.50	162.0	47	25.00	20.00	24	4	34.50	—
E513M36X2.0N02	36	2.00	162.0	47	25.00	20.00	24	4	34.00	—
E513M36X2.0N03	36	2.00	162.0	47	25.00	20.00	24	4	34.00	—
E513M36X3.0N02	36	3.00	162.0	47	25.00	20.00	24	4	33.00	—
E513M36X3.0N03	36	3.00	162.0	47	25.00	20.00	24	4	33.00	—
E513M39X3.0N02	39	3.00	170.0	47	28.00	22.40	26	4	36.00	—
E513M39X3.0N03	39	3.00	170.0	47	28.00	22.40	26	4	36.00	—
E513M40X1.5N02	40	1.50	170.0	53	28.00	22.40	26	6	38.50	—
E513M40X1.5N03	40	1.50	170.0	53	28.00	22.40	26	6	38.50	—
E513M42X1.5N02	42	1.50	170.0	53	28.00	22.40	26	6	40.50	—
E513M42X1.5N03	42	1.50	170.0	53	28.00	22.40	26	6	40.50	—
E513M42X3.0N03	42	3.00	170.0	53	28.00	22.40	26	6	39.00	—
E513M45X1.5N02	45	1.50	187.0	54	31.50	25.00	28	6	43.50	—
E513M45X1.5N03	45	1.50	187.0	54	31.50	25.00	28	6	43.50	—
E513M48X1.5N03	48	1.50	187.0	60	31.50	25.00	28	6	46.50	—
E513M48X2.0N03	48	2.00	187.0	60	31.50	25.00	28	6	46.00	—
E513M48X3.0N03	48	3.00	187.0	60	31.50	25.00	28	6	45.00	—
E513M50X1.5N02	50	1.50	187.0	60	31.50	25.00	28	6	48.50	—
E513M50X1.5N03	50	1.50	187.0	60	31.50	25.00	28	6	48.50	—

E515



HSS Straight Flute Hand Tap, UNC, ISO Standard

A versatile tool, suitable for hand and machine tapping. With a straight flute design for both through and blind holes. Available as a set of three NO6 or as separate taps with taper lead NO1 for short through holes, plug lead NO2 for deeper through holes or bottoming lead NO3 for blind holes.

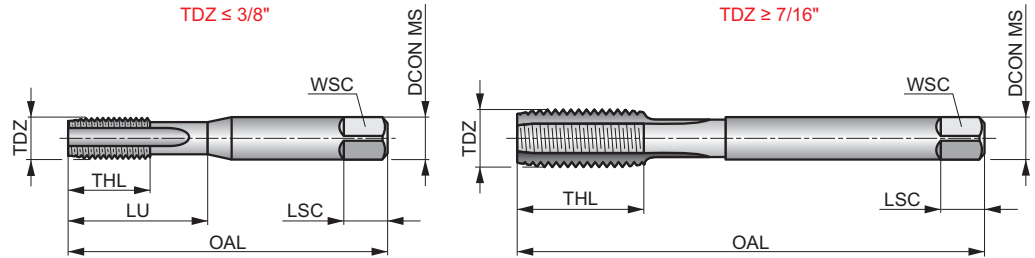

	ISO 529	2B
	1.5×D	HSS
	R	Bright

Workpiece material group suitability and starting values for cutting speed (m/min).

P1.1 ■7	P1.2 ■7	P1.3 ■8	P2.1 ■6	P2.2 ■5	P2.3 ▣4	P3.1 ■4	P3.2 ▣4	P4.1 ▣3	K1.1 ▣12	K1.2 ▣9	K1.3 ▣7	K2.1 ▣12	K2.2 ▣10
K3.1 ▣11	K3.2 ▣8	K4.1 ▣10	K4.2 ▣8	K5.1 ▣11	K5.2 ▣9	N1.3 ▣8	N2.1 ▣11	N2.2 ▣10	N2.3 ▣7	N3.1 ■17	N3.2 ■10	N3.3 ▣5	N4.2 ▣5
N4.3 ▣3													

Products from this series are also available in set with dies. Please see L120.

Product	TDZ	TPI	TD	OAL	THL	DCON MS	WSC	LSC	NOF	PHD	LU
E5151-64N01	1	64	1.854	41.0	8	2.50	2.00	4	2	1.55	8.00
E5151-64N02	1	64	1.854	41.0	8	2.50	2.00	4	2	1.55	8.00
E5151-64N03	1	64	1.854	41.0	8	2.50	2.00	4	2	1.55	8.00
E5151-64N06	1	64	1.854	41.0	8	2.50	2.00	4	2	1.55	8.00
E5152-56N01	2	56	2.184	44.5	9.5	2.80	2.24	5	3	1.85	9.50
E5152-56N02	2	56	2.184	44.5	9.5	2.80	2.24	5	3	1.85	9.50
E5152-56N03	2	56	2.184	44.5	9.5	2.80	2.24	5	3	1.85	9.50
E5152-56N06	2	56	2.184	44.5	9.5	2.80	2.24	5	3	1.85	9.50
E5153-48N01	3	48	2.515	44.5	9.5	2.80	2.24	5	3	2.10	9.50
E5153-48N02	3	48	2.515	44.5	9.5	2.80	2.24	5	3	2.10	9.50
E5153-48N03	3	48	2.515	44.5	9.5	2.80	2.24	5	3	2.10	9.50
E5153-48N06	3	48	2.515	44.5	9.5	2.80	2.24	5	3	2.10	9.50
E5154-40N01	4	40	2.845	48.0	12.5	3.15	2.50	5	3	2.35	12.50
E5154-40N02	4	40	2.845	48.0	12.5	3.15	2.50	5	3	2.35	12.50
E5154-40N03	4	40	2.845	48.0	12.5	3.15	2.50	5	3	2.35	12.50
E5154-40N06	4	40	2.845	48.0	12.5	3.15	2.50	5	3	2.35	12.50
E5155-40N01	5	40	3.175	48.0	12.5	3.15	2.50	5	3	2.65	12.50
E5155-40N02	5	40	3.175	48.0	12.5	3.15	2.50	5	3	2.65	12.50
E5155-40N03	5	40	3.175	48.0	12.5	3.15	2.50	5	3	2.65	12.50
E5155-40N06	5	40	3.175	48.0	12.5	3.15	2.50	5	3	2.65	12.50
E5156-32N01	6	32	3.505	50.0	14	3.55	2.80	5	3	2.85	14.00
E5156-32N02	6	32	3.505	50.0	14	3.55	2.80	5	3	2.85	14.00
E5156-32N03	6	32	3.505	50.0	14	3.55	2.80	5	3	2.85	14.00
E5156-32N06	6	32	3.505	50.0	14	3.55	2.80	5	3	2.85	14.00
E5158-32N01	8	32	4.166	53.0	9.5	4.50	3.55	6	3	3.50	17.00
E5158-32N02	8	32	4.166	53.0	9.5	4.50	3.55	6	3	3.50	17.00
E5158-32N03	8	32	4.166	53.0	9.5	4.50	3.55	6	3	3.50	17.00



Product	TDZ	TPI	TD	OAL	THL	DCON MS	WSC	LSC	NOF	PHD	LU
			(mm)	(mm)	(mm)	(mm)	(mm)	(mm)		(mm)	
E5158-32N06	8	32	4.166	53.0	9.5	4.50	3.55	6	3	3.50	17.00
E51510-24N01	10	24	4.826	58.0	11	5.00	4.00	7	3	3.90	20.00
E51510-24N02	10	24	4.826	58.0	11	5.00	4.00	7	3	3.90	20.00
E51510-24N03	10	24	4.826	58.0	11	5.00	4.00	7	3	3.90	20.00
E51510-24N06	10	24	4.826	58.0	11	5.00	4.00	7	3	3.90	20.00
E51512-24N01	12	24	5.486	62.0	12	5.60	4.50	7	3	4.50	21.00
E51512-24N02	12	24	5.486	62.0	12	5.60	4.50	7	3	4.50	21.00
E51512-24N03	12	24	5.486	62.0	12	5.60	4.50	7	3	4.50	21.00
E51512-24N06	12	24	5.486	62.0	12	5.60	4.50	7	3	4.50	21.00
E5151/4N01	1/4	20	6.350	66.0	13	6.30	5.00	8	3	5.10	26.00
E5151/4N02	1/4	20	6.350	66.0	13	6.30	5.00	8	3	5.10	26.00
E5151/4N03	1/4	20	6.350	66.0	13	6.30	5.00	8	3	5.10	26.00
E5151/4N06	1/4	20	6.350	66.0	13	6.30	5.00	8	3	5.10	26.00
E5155/16N01	5/16	18	7.938	72.0	16	8.00	6.30	9	3	6.60	29.00
E5155/16N02	5/16	18	7.938	72.0	16	8.00	6.30	9	3	6.60	29.00
E5155/16N03	5/16	18	7.938	72.0	16	8.00	6.30	9	3	6.60	29.00
E5155/16N06	5/16	18	7.938	72.0	16	8.00	6.30	9	3	6.60	29.00
E5153/8N01	3/8	16	9.525	80.0	18	10.00	8.00	11	3	8.00	32.00
E5153/8N02	3/8	16	9.525	80.0	18	10.00	8.00	11	3	8.00	32.00
E5153/8N03	3/8	16	9.525	80.0	18	10.00	8.00	11	3	8.00	32.00
E5153/8N06	3/8	16	9.525	80.0	18	10.00	8.00	11	3	8.00	32.00
E5157/16N01	7/16	14	11.112	85.0	19	8.00	6.30	9	3	9.40	-
E5157/16N02	7/16	14	11.112	85.0	19	8.00	6.30	9	3	9.40	-
E5157/16N03	7/16	14	11.112	85.0	19	8.00	6.30	9	3	9.40	-
E5157/16N06	7/16	14	11.112	85.0	19	8.00	6.30	9	3	9.40	-
E5151/2N01	1/2	13	12.700	89.0	22	9.00	7.10	10	3	10.80	-
E5151/2N02	1/2	13	12.700	89.0	22	9.00	7.10	10	3	10.80	-
E5151/2N03	1/2	13	12.700	89.0	22	9.00	7.10	10	3	10.80	-
E5151/2N06	1/2	13	12.700	89.0	22	9.00	7.10	10	3	10.80	-
E5159/16N01	9/16	12	14.288	95.0	24	11.20	9.00	12	4	12.20	-
E5159/16N02	9/16	12	14.288	95.0	24	11.20	9.00	12	4	12.20	-
E5159/16N03	9/16	12	14.288	95.0	24	11.20	9.00	12	4	12.20	-
E5159/16N06	9/16	12	14.288	95.0	24	11.20	9.00	12	4	12.20	-
E5155/8N01	5/8	11	15.875	102.0	24	12.50	10.00	13	4	13.50	-
E5155/8N02	5/8	11	15.875	102.0	24	12.50	10.00	13	4	13.50	-
E5155/8N03	5/8	11	15.875	102.0	24	12.50	10.00	13	4	13.50	-
E5155/8N06	5/8	11	15.875	102.0	24	12.50	10.00	13	4	13.50	-
E5153/4N01	3/4	10	19.050	112.0	29	14.00	11.20	14	4	16.50	-
E5153/4N02	3/4	10	19.050	112.0	29	14.00	11.20	14	4	16.50	-
E5153/4N03	3/4	10	19.050	112.0	29	14.00	11.20	14	4	16.50	-
E5153/4N06	3/4	10	19.050	112.0	29	14.00	11.20	14	4	16.50	-
E5157/8N01	7/8	9	22.225	118.0	29	16.00	12.50	16	4	19.50	-
E5157/8N02	7/8	9	22.225	118.0	29	16.00	12.50	16	4	19.50	-
E5157/8N03	7/8	9	22.225	118.0	29	16.00	12.50	16	4	19.50	-
E5157/8N06	7/8	9	22.225	118.0	29	16.00	12.50	16	4	19.50	-
E5151N03	1"	8	25.400	130.0	35	18.00	14.00	18	4	22.25	-
E5151N01	1"	8	25.400	130.0	35	18.00	14.00	18	4	22.25	-
E5151N02	1"	8	25.400	130.0	35	18.00	14.00	18	4	22.25	-
E5151N06	1"	8	25.400	130.0	35	18.00	14.00	18	4	22.25	-
E5151.1/8N01	1.1/8	7	28.575	138.0	35	20.00	16.00	20	4	25.00	-
E5151.1/8N02	1.1/8	7	28.575	138.0	35	20.00	16.00	20	4	25.00	-
E5151.1/8N03	1.1/8	7	28.575	138.0	35	20.00	16.00	20	4	25.00	-
E5151.1/4N01	1.1/4	7	31.750	151.0	41	22.40	18.00	22	4	28.00	-
E5151.1/4N02	1.1/4	7	31.750	151.0	41	22.40	18.00	22	4	28.00	-
E5151.1/4N03	1.1/4	7	31.750	151.0	41	22.40	18.00	22	4	28.00	-
E5151.3/8N01	1.3/8	6	34.925	162.0	47	25.00	20.00	24	4	30.75	-
E5151.3/8N02	1.3/8	6	34.925	162.0	47	25.00	20.00	24	4	30.75	-
E5151.3/8N03	1.3/8	6	34.925	162.0	47	25.00	20.00	24	4	30.75	-
E5151.1/2N01	1.1/2	6	38.100	170.0	47	28.00	22.40	26	4	34.00	-
E5151.1/2N02	1.1/2	6	38.100	170.0	47	28.00	22.40	26	4	34.00	-
E5151.1/2N03	1.1/2	6	38.100	170.0	47	28.00	22.40	26	4	34.00	-
E5151.3/4N01	1.3/4	5	44.450	187.0	54	31.50	25.00	28	6	39.50	-
E5151.3/4N02	1.3/4	5	44.450	187.0	54	31.50	25.00	28	6	39.50	-
E5151.3/4N03	1.3/4	5	44.450	187.0	54	31.50	25.00	28	6	39.50	-
E5152N03	2"	4.5	50.800	200.0	60	35.50	28.00	31	6	45.00	-
E5152N01	2"	4.5	50.800	200.0	60	35.50	28.00	31	6	45.00	-
E5152N02	2"	4.5	50.800	200.0	60	35.50	28.00	31	6	45.00	-

E524



HSS Straight Flute Hand Tap, UNF, ISO Standard

A versatile tool, suitable for hand and machine tapping. With a straight flute design for both through and blind holes. Available as a set of three NO6 or as separate taps with taper lead NO1 for short through holes, plug lead NO2 for deeper through holes or bottoming lead NO3 for blind holes.

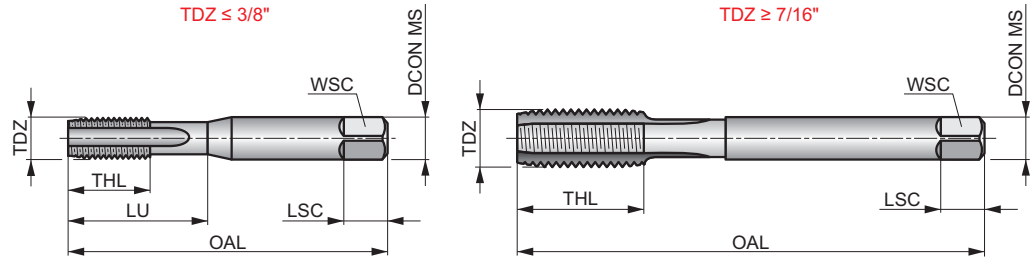

	ISO 529	2B
	1.5xD	HSS
	R	Bright

Workpiece material group suitability and starting values for cutting speed (m/min).

P1.1 ■7	P1.2 ■7	P1.3 ■8	P2.1 ■6	P2.2 ■5	P2.3 ▣4	P3.1 ■4	P3.2 ▣4	P4.1 ▣3	K1.1 ▣12	K1.2 ▣9	K1.3 ▣7	K2.1 ▣12	K2.2 ▣10
K3.1 ▣11	K3.2 ▣8	K4.1 ▣10	K4.2 ▣8	K5.1 ▣11	K5.2 ▣9	N1.3 ▣8	N2.1 ▣11	N2.2 ▣10	N2.3 ▣7	N3.1 ■17	N3.2 ■10	N3.3 ▣5	N4.2 ▣5
N4.3 ▣3													

Products from this series are also available in set with dies. Please see L120.

Product	TDZ	TPI	TD	OAL	THL	DCON MS	WSC	LSC	NOF	PHD	LU
E5240-80N01	0	80	1.524	41.0	7	2.50	2.00	4	2	1.25	7.00
E5240-80N02	0	80	1.524	41.0	7	2.50	2.00	4	2	1.25	7.00
E5240-80N03	0	80	1.524	41.0	7	2.50	2.00	4	2	1.25	7.00
E5241-72N01	1	72	1.854	41.0	8	2.50	2.00	4	2	1.55	8.00
E5241-72N02	1	72	1.854	41.0	8	2.50	2.00	4	2	1.55	8.00
E5241-72N03	1	72	1.854	41.0	8	2.50	2.00	4	2	1.55	8.00
E5242-64N01	2	64	2.184	44.5	9.5	2.80	2.24	5	3	1.90	9.50
E5242-64N02	2	64	2.184	44.5	9.5	2.80	2.24	5	3	1.90	9.50
E5242-64N03	2	64	2.184	44.5	9.5	2.80	2.24	5	3	1.90	9.50
E5244-48N01	4	48	2.845	48.0	12.5	3.15	2.50	5	3	2.40	12.50
E5244-48N02	4	48	2.845	48.0	12.5	3.15	2.50	5	3	2.40	12.50
E5244-48N03	4	48	2.845	48.0	12.5	3.15	2.50	5	3	2.40	12.50
E5245-44N01	5	44	3.175	48.0	12.5	3.15	2.50	5	3	2.70	12.50
E5245-44N02	5	44	3.175	48.0	12.5	3.15	2.50	5	3	2.70	12.50
E5245-44N03	5	44	3.175	48.0	12.5	3.15	2.50	5	3	2.70	12.50
E5246-40N01	6	40	3.505	50.0	14	3.55	2.80	5	3	2.95	14.00
E5246-40N02	6	40	3.505	50.0	14	3.55	2.80	5	3	2.95	14.00
E5246-40N03	6	40	3.505	50.0	14	3.55	2.80	5	3	2.95	14.00
E5248-36N01	8	36	4.166	53.0	9.5	4.50	3.55	6	3	3.50	17.00
E5248-36N02	8	36	4.166	53.0	9.5	4.50	3.55	6	3	3.50	17.00
E5248-36N03	8	36	4.166	53.0	9.5	4.50	3.55	6	3	3.50	17.00
E52410-32N01	10	32	4.826	58.0	11	5.00	4.00	7	3	4.10	20.00
E52410-32N02	10	32	4.826	58.0	11	5.00	4.00	7	3	4.10	20.00
E52410-32N03	10	32	4.826	58.0	11	5.00	4.00	7	3	4.10	20.00
E52410-32N06	10	32	4.826	58.0	11	5.00	4.00	7	3	4.10	20.00
E52412-28N01	12	28	5.486	62.0	12	5.60	4.50	7	3	4.70	21.00
E52412-28N02	12	28	5.486	62.0	12	5.60	4.50	7	3	4.70	21.00



Product	TDZ	TPI	TD	OAL	THL	DCON MS	WSC	LSC	NOF	PHD	LU
			(mm)	(mm)	(mm)	(mm)	(mm)	(mm)	(mm)	(mm)	(mm)
E52412-28N03	12	28	5.486	62.0	12	5.60	4.50	7	3	4.70	21.00
E52412-28N06	12	28	5.486	62.0	12	5.60	4.50	7	3	4.70	21.00
E5241/4N01	1/4	28	6.350	66.0	13	6.30	5.00	8	3	5.50	26.00
E5241/4N02	1/4	28	6.350	66.0	13	6.30	5.00	8	3	5.50	26.00
E5241/4N03	1/4	28	6.350	66.0	13	6.30	5.00	8	3	5.50	26.00
E5241/4N06	1/4	28	6.350	66.0	13	6.30	5.00	8	3	5.50	26.00
E5245/16N01	5/16	24	7.938	72.0	16	8.00	6.30	9	3	6.90	29.00
E5245/16N02	5/16	24	7.938	72.0	16	8.00	6.30	9	3	6.90	29.00
E5245/16N03	5/16	24	7.938	72.0	16	8.00	6.30	9	3	6.90	29.00
E5245/16N06	5/16	24	7.938	72.0	16	8.00	6.30	9	3	6.90	29.00
E5243/8N01	3/8	24	9.525	80.0	18	10.00	8.00	11	3	8.50	32.00
E5243/8N02	3/8	24	9.525	80.0	18	10.00	8.00	11	3	8.50	32.00
E5243/8N03	3/8	24	9.525	80.0	18	10.00	8.00	11	3	8.50	32.00
E5243/8N06	3/8	24	9.525	80.0	18	10.00	8.00	11	3	8.50	32.00
E5247/16N01	7/16	20	11.112	85.0	19	8.00	6.30	9	3	9.90	-
E5247/16N02	7/16	20	11.112	85.0	19	8.00	6.30	9	3	9.90	-
E5247/16N03	7/16	20	11.112	85.0	19	8.00	6.30	9	3	9.90	-
E5247/16N06	7/16	20	11.112	85.0	19	8.00	6.30	9	3	9.90	-
E5241/2N01	1/2	20	12.700	89.0	22	9.00	7.10	10	3	11.50	-
E5241/2N02	1/2	20	12.700	89.0	22	9.00	7.10	10	3	11.50	-
E5241/2N03	1/2	20	12.700	89.0	22	9.00	7.10	10	3	11.50	-
E5241/2N06	1/2	20	12.700	89.0	22	9.00	7.10	10	3	11.50	-
E5249/16N01	9/16	18	14.288	95.0	24	11.20	9.00	12	4	12.90	-
E5249/16N02	9/16	18	14.288	95.0	24	11.20	9.00	12	4	12.90	-
E5249/16N03	9/16	18	14.288	95.0	24	11.20	9.00	12	4	12.90	-
E5249/16N06	9/16	18	14.288	95.0	24	11.20	9.00	12	4	12.90	-
E5245/8N01	5/8	18	15.875	102.0	24	12.50	10.00	13	4	14.50	-
E5245/8N02	5/8	18	15.875	102.0	24	12.50	10.00	13	4	14.50	-
E5245/8N03	5/8	18	15.875	102.0	24	12.50	10.00	13	4	14.50	-
E5245/8N06	5/8	18	15.875	102.0	24	12.50	10.00	13	4	14.50	-
E5243/4N01	3/4	16	19.050	112.0	29	14.00	11.20	14	4	17.50	-
E5243/4N02	3/4	16	19.050	112.0	29	14.00	11.20	14	4	17.50	-
E5243/4N03	3/4	16	19.050	112.0	29	14.00	11.20	14	4	17.50	-
E5243/4N06	3/4	16	19.050	112.0	29	14.00	11.20	14	4	17.50	-
E5247/8N01	7/8	14	22.225	118.0	29	16.00	12.50	16	4	20.40	-
E5247/8N02	7/8	14	22.225	118.0	29	16.00	12.50	16	4	20.40	-
E5247/8N03	7/8	14	22.225	118.0	29	16.00	12.50	16	4	20.40	-
E5247/8N06	7/8	14	22.225	118.0	29	16.00	12.50	16	4	20.40	-
E5241N01	1"	12	25.400	130.0	35	18.00	14.00	18	4	23.25	-
E5241N02	1"	12	25.400	130.0	35	18.00	14.00	18	4	23.25	-
E5241N03	1"	12	25.400	130.0	35	18.00	14.00	18	4	23.25	-
E5241N06	1"	12	25.400	130.0	35	18.00	14.00	18	4	23.25	-
E5241.1/8N01	1.1/8	12	28.575	138.0	35	20.00	16.00	20	4	26.50	-
E5241.1/8N02	1.1/8	12	28.575	138.0	35	20.00	16.00	20	4	26.50	-
E5241.1/8N03	1.1/8	12	28.575	138.0	35	20.00	16.00	20	4	26.50	-
E5241.1/4N01	1.1/4	12	31.750	151.0	41	22.40	18.00	22	4	29.50	-
E5241.1/4N02	1.1/4	12	31.750	151.0	41	22.40	18.00	22	4	29.50	-
E5241.1/4N03	1.1/4	12	31.750	151.0	41	22.40	18.00	22	4	29.50	-
E5241.3/8N01	1.3/8	12	34.925	162.0	47	25.00	20.00	24	4	32.75	-
E5241.3/8N02	1.3/8	12	34.925	162.0	47	25.00	20.00	24	4	32.75	-
E5241.3/8N03	1.3/8	12	34.925	162.0	47	25.00	20.00	24	4	32.75	-
E5241.1/2N01	1.1/2	12	38.100	170.0	47	28.00	22.40	26	4	36.00	-
E5241.1/2N02	1.1/2	12	38.100	170.0	47	28.00	22.40	26	4	36.00	-
E5241.1/2N03	1.1/2	12	38.100	170.0	47	28.00	22.40	26	4	36.00	-

E531



HSS Straight Flute Hand Tap, BSW, ISO Standard

A versatile tool, suitable for hand and machine tapping, with a straight flute design for both through and blind holes. Available as a set of three NO6 or as separate taps with taper lead NO1 for short through holes, plug lead NO2 for deeper through holes or bottoming lead NO3 for blind holes.

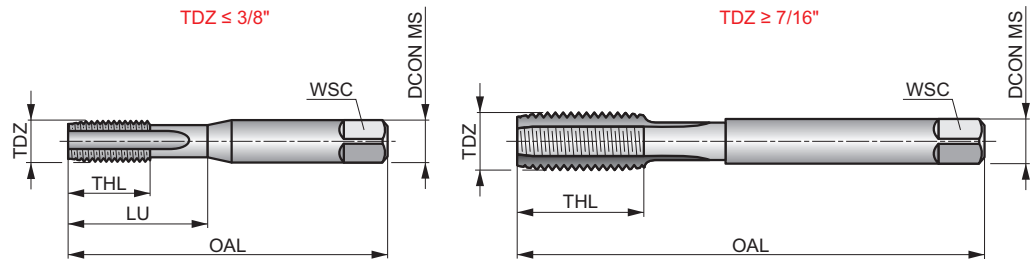

	ISO 529	Medium
	1.5xD	HSS
	R	Bright

Workpiece material group suitability and starting values for cutting speed (m/min).

P1.1 ■7	P1.2 ■7	P1.3 ■8	P2.1 ■6	P2.2 ■5	P2.3 ▣4	P3.1 ■4	P3.2 ▣4	P4.1 ▣3	K1.1 ▣12	K1.2 ▣9	K1.3 ▣7	K2.1 ▣12	K2.2 ▣10
K3.1 ▣11	K3.2 ▣8	K4.1 ▣10	K4.2 ▣8	K5.1 ▣11	K5.2 ▣9	N1.3 ▣8	N2.1 ▣11	N2.2 ▣10	N2.3 ▣7	N3.1 ■17	N3.2 ■10	N3.3 ▣5	N4.2 ▣5
N4.3 ▣3													

Product	TDZ	TPI	TD	OAL	THL	DCON MS	WSC	NOF	PHD	LU
			(mm)	(mm)	(mm)	(mm)	(mm)		(mm)	(mm)
E5311/8N01	1/8	40	3.175	48.0	12.5	3.15	2.50	3	2.55	12.50
E5311/8N02	1/8	40	3.175	48.0	12.5	3.15	2.50	3	2.55	12.50
E5311/8N03	1/8	40	3.175	48.0	12.5	3.15	2.50	3	2.55	12.50
E5311/8N06	1/8	40	3.175	48.0	12.5	3.15	2.50	3	2.55	12.50
E5315/32N01	5/32	32	3.969	53.0	14	4.00	3.15	3	3.20	14.00
E5315/32N02	5/32	32	3.969	53.0	14	4.00	3.15	3	3.20	14.00
E5315/32N03	5/32	32	3.969	53.0	14	4.00	3.15	3	3.20	14.00
E5315/32N06	5/32	32	3.969	53.0	14	4.00	3.15	3	3.20	14.00
E5313/16N01	3/16	24	4.763	58.0	11	5.00	4.00	3	3.70	20.00
E5313/16N02	3/16	24	4.763	58.0	11	5.00	4.00	3	3.70	20.00
E5313/16N03	3/16	24	4.763	58.0	11	5.00	4.00	3	3.70	20.00
E5313/16N06	3/16	24	4.763	58.0	11	5.00	4.00	3	3.70	20.00
E5311/4N01	1/4	20	6.350	66.0	13	6.30	5.00	3	5.10	26.00
E5311/4N02	1/4	20	6.350	66.0	13	6.30	5.00	3	5.10	26.00
E5311/4N03	1/4	20	6.350	66.0	13	6.30	5.00	3	5.10	26.00
E5311/4N06	1/4	20	6.350	66.0	13	6.30	5.00	3	5.10	26.00
E5315/16N01	5/16	18	7.938	72.0	16	8.00	6.30	3	6.50	29.00
E5315/16N02	5/16	18	7.938	72.0	16	8.00	6.30	3	6.50	29.00
E5315/16N03	5/16	18	7.938	72.0	16	8.00	6.30	3	6.50	29.00
E5315/16N06	5/16	18	7.938	72.0	16	8.00	6.30	3	6.50	29.00
E5313/8N01	3/8	16	9.525	80.0	18	10.00	8.00	3	7.90	32.00
E5313/8N02	3/8	16	9.525	80.0	18	10.00	8.00	3	7.90	32.00
E5313/8N03	3/8	16	9.525	80.0	18	10.00	8.00	3	7.90	32.00
E5313/8N06	3/8	16	9.525	80.0	18	10.00	8.00	3	7.90	32.00
E5317/16N01	7/16	14	11.112	85.0	19	8.00	6.30	3	9.20	—
E5317/16N02	7/16	14	11.112	85.0	19	8.00	6.30	3	9.20	—
E5317/16N03	7/16	14	11.112	85.0	19	8.00	6.30	3	9.20	—
E5317/16N06	7/16	14	11.112	85.0	19	8.00	6.30	3	9.20	—



Product	TDZ	TPI	TD	OAL	THL	DCON MS	WSC	NOF	PHD	LU
			(mm)	(mm)	(mm)	(mm)	(mm)	(mm)	(mm)	(mm)
E5311/2N01	1/2	12	12.700	89.0	22	9.00	7.10	3	10.50	—
E5311/2N02	1/2	12	12.700	89.0	22	9.00	7.10	3	10.50	—
E5311/2N03	1/2	12	12.700	89.0	22	9.00	7.10	3	10.50	—
E5311/2N06	1/2	12	12.700	89.0	22	9.00	7.10	3	10.50	—
E5315/8N01	5/8	11	15.875	102.0	24	12.50	10.00	4	13.50	—
E5315/8N02	5/8	11	15.875	102.0	24	12.50	10.00	4	13.50	—
E5315/8N03	5/8	11	15.875	102.0	24	12.50	10.00	4	13.50	—
E5315/8N06	5/8	11	15.875	102.0	24	12.50	10.00	4	13.50	—
E5313/4N01	3/4	10	19.050	112.0	29	14.00	11.20	4	16.50	—
E5313/4N02	3/4	10	19.050	112.0	29	14.00	11.20	4	16.50	—
E5313/4N03	3/4	10	19.050	112.0	29	14.00	11.20	4	16.50	—
E5313/4N06	3/4	10	19.050	112.0	29	14.00	11.20	4	16.50	—
E5311N01	1"	8	25.400	130.0	35	18.00	14.00	4	22.00	—
E5311N02	1"	8	25.400	130.0	35	18.00	14.00	4	22.00	—
E5311N03	1"	8	25.400	130.0	35	18.00	14.00	4	22.00	—
E5311N06	1"	8	25.400	130.0	35	18.00	14.00	4	22.00	—

E536



HSS Straight Flute Hand Tap, BSF, ISO Standard

A versatile tool, suitable for hand and machine tapping, with a straight flute design for both through and blind holes. Available as a set of three NO6 or as separate taps with taper lead NO1 for short through holes, plug lead NO2 for deeper through holes or bottoming lead NO3 for blind holes.

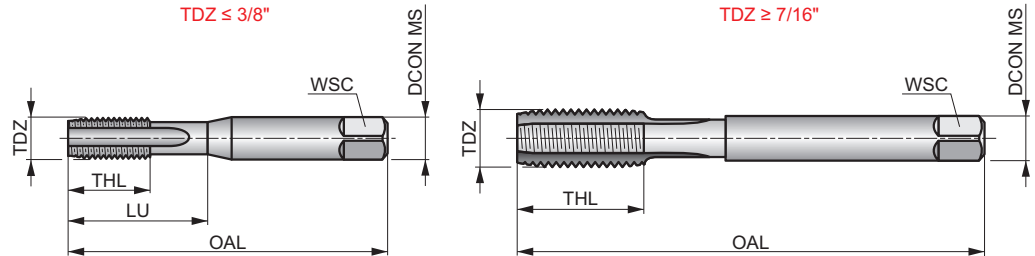

	ISO 529	Medium
	1.5xD	HSS
	R	Bright

Workpiece material group suitability and starting values for cutting speed (m/min).

P1.1 ■7	P1.2 ■7	P1.3 ■8	P2.1 ■6	P2.2 ■5	P2.3 ▣4	P3.1 ■4	P3.2 ▣4	P4.1 ▣3	K1.1 ▣12	K1.2 ▣9	K1.3 ▣7	K2.1 ▣12	K2.2 ▣10
K3.1 ▣11	K3.2 ▣8	K4.1 ▣10	K4.2 ▣8	K5.1 ▣11	K5.2 ▣9	N1.3 ▣8	N2.1 ▣11	N2.2 ▣10	N2.3 ▣7	N3.1 ■17	N3.2 ■10	N3.3 ▣5	N4.2 ▣5
N4.3 ▣3													

Product	TDZ	TPI	TD	OAL	THL	DCON MS	WSC	NOF	PHD	LU
			(mm)	(mm)	(mm)	(mm)	(mm)			
E5363/16N01	3/16	32	4.760	58.0	12	5.00	4.00	3	4.00	20.00
E5363/16N02	3/16	32	4.760	58.0	12	5.00	4.00	3	4.00	20.00
E5363/16N03	3/16	32	4.760	58.0	12	5.00	4.00	3	4.00	20.00
E5363/16N06	3/16	32	4.760	58.0	12	5.00	4.00	3	4.00	20.00
E5361/4N01	1/4	26	6.350	66.0	14	6.30	5.00	3	5.30	26.00
E5361/4N02	1/4	26	6.350	66.0	14	6.30	5.00	3	5.30	26.00
E5361/4N03	1/4	26	6.350	66.0	14	6.30	5.00	3	5.30	26.00
E5361/4N06	1/4	26	6.350	66.0	14	6.30	5.00	3	5.30	26.00
E5365/16N01	5/16	22	7.940	72.0	18	8.00	6.30	3	6.80	29.00
E5365/16N02	5/16	22	7.940	72.0	18	8.00	6.30	3	6.80	29.00
E5365/16N03	5/16	22	7.940	72.0	18	8.00	6.30	3	6.80	29.00
E5365/16N06	5/16	22	7.940	72.0	18	8.00	6.30	3	6.80	29.00
E5363/8N01	3/8	20	9.530	80.0	20	10.00	8.00	3	8.30	32.00
E5363/8N02	3/8	20	9.530	80.0	20	10.00	8.00	3	8.30	32.00
E5363/8N03	3/8	20	9.530	80.0	20	10.00	8.00	3	8.30	32.00
E5363/8N06	3/8	20	9.530	80.0	20	10.00	8.00	3	8.30	32.00
E5367/16N01	7/16	18	11.110	85.0	20	8.00	6.30	3	9.70	—
E5367/16N02	7/16	18	11.110	85.0	20	8.00	6.30	3	9.70	—
E5367/16N03	7/16	18	11.110	85.0	20	8.00	6.30	3	9.70	—
E5361/2N01	1/2	16	12.700	89.0	23	9.00	7.10	3	11.00	—
E5361/2N02	1/2	16	12.700	89.0	23	9.00	7.10	3	11.00	—
E5361/2N03	1/2	16	12.700	89.0	23	9.00	7.10	3	11.00	—
E5361/2N06	1/2	16	12.700	89.0	23	9.00	7.10	3	11.00	—
E5369/16N01	9/16	16	14.280	95.0	25	11.20	9.00	4	12.70	—
E5369/16N02	9/16	16	14.280	95.0	25	11.20	9.00	4	12.70	—
E5369/16N03	9/16	16	14.280	95.0	25	11.20	9.00	4	12.70	—
E5365/8N01	5/8	14	15.880	102.0	25	12.50	10.00	4	14.00	—
E5365/8N02	5/8	14	15.880	102.0	25	12.50	10.00	4	14.00	—



Product	TDZ	TPI	TD	OAL	THL	DCON MS	WSC	NOF	PHD	LU
			(mm)	(mm)	(mm)	(mm)	(mm)	(mm)	(mm)	(mm)
E5365/8N03	5/8	14	15.880	102.0	25	12.50	10.00	4	14.00	—
E5363/4N01	3/4	12	19.050	112.0	30	14.00	11.20	4	17.00	—
E5363/4N02	3/4	12	19.050	112.0	30	14.00	11.20	4	17.00	—
E5363/4N03	3/4	12	19.050	112.0	30	14.00	11.20	4	17.00	—
E5367/8N01	7/8	11	22.230	118.0	30	16.00	12.50	4	19.75	—
E5367/8N02	7/8	11	22.230	118.0	30	16.00	12.50	4	19.75	—
E5367/8N03	7/8	11	22.230	118.0	30	16.00	12.50	4	19.75	—
E5367/8N06	7/8	11	22.230	118.0	30	16.00	12.50	4	19.75	—
E5361N01	1"	10	25.400	130.0	36	18.00	14.00	4	22.75	—
E5361N02	1"	10	25.400	130.0	36	18.00	14.00	4	22.75	—
E5361N03	1"	10	25.400	130.0	36	18.00	14.00	4	22.75	—

E542

HSS Straight Flute Hand Tap, BA, ISO Standard

A versatile tool, suitable for hand and machine tapping, with a straight flute design for both through and blind holes. Available as a set of three NO6 or as separate taps with taper lead NO1 for short through holes, plug lead NO2 for deeper through holes or bottoming lead NO3 for blind holes.

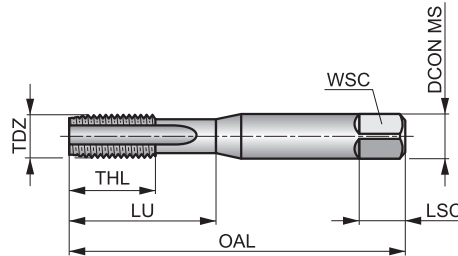

	ISO 529	Normal
	1.5xD	HSS
		Bright

Workpiece material group suitability and starting values for cutting speed (m/min).

P1.1 ■7	P1.2 ■7	P1.3 ■8	P2.1 ■6	P2.2 ■5	P2.3 ▣4	P3.1 ■4	P3.2 ▣4	P4.1 ▣3	K1.1 ▣12	K1.2 ▣9	K1.3 ▣7	K2.1 ▣12	K2.2 ▣10
K3.1 ▣11	K3.2 ▣8	K4.1 ▣10	K4.2 ▣8	K5.1 ▣11	K5.2 ▣9	N1.3 ▣8	N2.1 ▣11	N2.2 ▣10	N2.3 ▣7	N3.1 ■17	N3.2 ■10	N3.3 ▣5	N4.2 ▣5
N4.3 ▣3													

Product	TDZ	TP	TD	OAL	THL	DCON MS	WSC	LSC	NOF	PHD	LU
	(mm)	(mm)	(mm)	(mm)	(mm)	(mm)	(mm)	(mm)	(mm)	(mm)	(mm)
E542BA10N01	BA10	0.35	1.700	41.0	7	2.50	2.00	4	2	1.30	7.00
E542BA10N02	BA10	0.35	1.700	41.0	7	2.50	2.00	4	2	1.30	7.00
E542BA10N03	BA10	0.35	1.700	41.0	7	2.50	2.00	4	2	1.30	7.00
E542BA10N06	BA10	0.35	1.700	41.0	7	2.50	2.00	4	2	1.30	7.00
E542BA8N01	BA 8	0.43	2.200	44.5	9.5	2.80	2.20	5	3	1.80	9.50
E542BA8N02	BA 8	0.43	2.200	44.5	9.5	2.80	2.20	5	3	1.80	9.50
E542BA8N03	BA 8	0.43	2.200	44.5	9.5	2.80	2.20	5	3	1.80	9.50
E542BA8N06	BA 8	0.43	2.200	44.5	9.5	2.80	2.20	5	3	1.80	9.50
E542BA6N01	BA 6	0.53	2.800	44.5	9.5	2.80	2.20	5	3	2.30	9.50
E542BA6N02	BA 6	0.53	2.800	44.5	9.5	2.80	2.20	5	3	2.30	9.50
E542BA6N03	BA 6	0.53	2.800	44.5	9.5	2.80	2.20	5	3	2.30	9.50
E542BA6N06	BA 6	0.53	2.800	44.5	9.5	2.80	2.20	5	3	2.30	9.50
E542BA5N01	BA 5	0.59	3.200	48.0	14.5	3.15	2.50	5	3	2.65	14.50
E542BA5N02	BA 5	0.59	3.200	48.0	14.5	3.15	2.50	5	3	2.65	14.50
E542BA5N03	BA 5	0.59	3.200	48.0	14.5	3.15	2.50	5	3	2.65	14.50
E542BA5N06	BA 5	0.59	3.200	48.0	14.5	3.15	2.50	5	3	2.65	14.50
E542BA4N01	BA 4	0.66	3.600	50.0	16.5	3.55	2.80	5	3	3.00	16.50
E542BA4N02	BA 4	0.66	3.600	50.0	16.5	3.55	2.80	5	3	3.00	16.50
E542BA4N03	BA 4	0.66	3.600	50.0	16.5	3.55	2.80	5	3	3.00	16.50
E542BA4N06	BA 4	0.66	3.600	50.0	16.5	3.55	2.80	5	3	3.00	16.50
E542BA3N01	BA 3	0.73	4.100	53.0	10	4.50	3.50	6	3	3.40	17.00
E542BA3N02	BA 3	0.73	4.100	53.0	10	4.50	3.50	6	3	3.40	17.00
E542BA3N03	BA 3	0.73	4.100	53.0	10	4.50	3.50	6	3	3.40	17.00
E542BA3N06	BA 3	0.73	4.100	53.0	10	4.50	3.50	6	3	3.40	17.00
E542BA2N01	BA 2	0.81	4.700	58.0	12	5.00	4.00	7	3	4.00	20.00
E542BA2N02	BA 2	0.81	4.700	58.0	12	5.00	4.00	7	3	4.00	20.00
E542BA2N03	BA 2	0.81	4.700	58.0	12	5.00	4.00	7	3	4.00	20.00
E542BA2N06	BA 2	0.81	4.700	58.0	12	5.00	4.00	7	3	4.00	20.00



Product	TDZ	TP	TD	OAL	THL	DCON MS	WSC	LSC	NOF	PHD	LU
		(mm)	(mm)	(mm)	(mm)	(mm)	(mm)	(mm)	(mm)	(mm)	(mm)
E542BA0N01	BA 0	1.00	6.000	66.0	14	6.30	5.00	8	3	5.10	26.00
E542BA0N02	BA 0	1.00	6.000	66.0	14	6.30	5.00	8	3	5.10	26.00
E542BA0N03	BA 0	1.00	6.000	66.0	14	6.30	5.00	8	3	5.10	26.00
E542BA0N06	BA 0	1.00	6.000	66.0	14	6.30	5.00	8	3	5.10	26.00

E547



HSS Straight Flute Hand Tap G(BSP), ISO Standard

A versatile tool, suitable for hand and machine tapping, with a straight flute design for both through and blind holes. Available with taper lead N01 for short through holes, plug lead N02 for deeper through holes or bottoming lead N03 for blind holes. Also, as set N07 with a plug lead and bottoming lead tap.

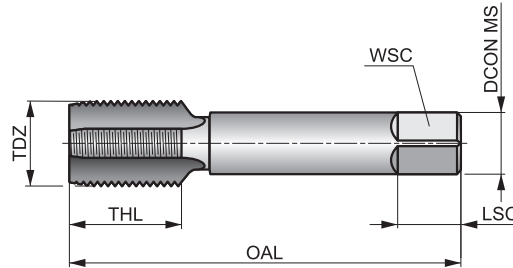

	ISO 2284	Normal
	1.5xD	HSS
	R	Bright

Workpiece material group suitability and starting values for cutting speed (m/min).

P1.1 ■7	P1.2 ■7	P1.3 ■8	P2.1 ■6	P2.2 ■5	P2.3 ▣4	P3.1 ■4	P3.2 ▣4	P4.1 ▣3	K1.1 ▣12	K1.2 ▣9	K1.3 ▣7	K2.1 ▣12	K2.2 ▣10
K3.1 ▣11	K3.2 ▣8	K4.1 ▣10	K4.2 ▣8	K5.1 ▣11	K5.2 ▣9	N1.3 ▣8	N2.1 ▣11	N2.2 ▣10	N2.3 ▣7	N3.1 ▣17	N3.2 ▣10	N3.3 ▣5	N4.2 ▣5
N4.3 ▣3													

Product	TDZ	TPI	TD	OAL	THL	DCON MS	WSC	LSC	NOF	PHD
			(mm)	(mm)	(mm)	(mm)	(mm)	(mm)		(mm)
E5471/8N01	1/8	28	9.728	59.0	15	8.00	8.00	9	4	8.80
E5471/8N02	1/8	28	9.728	59.0	15	8.00	6.30	9	4	8.80
E5471/8N03	1/8	28	9.728	59.0	15	8.00	6.30	9	4	8.80
E5471/8N07	1/8	28	9.728	59.0	15	8.00	6.30	9	4	8.80
E5471/4N01	1/4	19	13.157	67.0	19	10.00	8.00	11	4	11.80
E5471/4N02	1/4	19	13.157	67.0	19	10.00	8.00	11	4	11.80
E5471/4N03	1/4	19	13.157	67.0	19	10.00	8.00	11	4	11.80
E5471/4N07	1/4	19	13.157	67.0	19	10.00	8.00	11	4	11.80
E5473/8N01	3/8	19	16.662	75.0	21	12.50	10.00	13	4	15.25
E5473/8N02	3/8	19	16.662	75.0	21	12.50	10.00	13	4	15.25
E5473/8N03	3/8	19	16.662	75.0	21	12.50	10.00	13	4	15.25
E5473/8N07	3/8	19	16.662	75.0	21	12.50	10.00	13	4	15.25
E5471/2N01	1/2	14	20.955	87.0	26	16.00	12.50	16	4	19.00
E5471/2N02	1/2	14	20.955	87.0	26	16.00	12.50	16	4	19.00
E5471/2N03	1/2	14	20.955	87.0	26	16.00	12.50	16	4	19.00
E5471/2N07	1/2	14	20.955	87.0	26	16.00	12.50	16	4	19.00
E5475/8N01	5/8	14	22.911	91.0	26	18.00	14.00	18	4	21.00
E5475/8N02	5/8	14	22.911	91.0	26	18.00	14.00	18	4	21.00
E5475/8N03	5/8	14	22.911	91.0	26	18.00	14.00	18	4	21.00
E5475/8N07	5/8	14	22.911	91.0	26	18.00	14.00	18	4	21.00
E5473/4N01	3/4	14	26.441	96.0	28	20.00	16.00	20	4	24.50
E5473/4N02	3/4	14	26.441	96.0	28	20.00	16.00	20	4	24.50
E5473/4N03	3/4	14	26.441	96.0	28	20.00	16.00	20	4	24.50
E5473/4N07	3/4	14	26.441	96.0	28	20.00	16.00	20	4	24.50
E5477/8N01	7/8	14	30.201	102.0	29	22.40	18.00	22	4	28.25
E5477/8N02	7/8	14	30.201	102.0	29	22.40	18.00	22	4	28.25
E5477/8N03	7/8	14	30.201	102.0	29	22.40	18.00	22	4	28.25
E5471N01	1"	11	33.249	109.0	33	25.00	20.00	24	4	30.75



Product	TDZ	TPI	TD	OAL	THL	DCON MS	WSC	LSC	NOF	PHD
			(mm)	(mm)	(mm)	(mm)	(mm)	(mm)		(mm)
E5471N02	1"	11	33.249	109.0	33	25.00	20.00	24	4	30.75
E5471N03	1"	11	33.249	109.0	33	25.00	20.00	24	4	30.75
E5471.1/4N01	1.1/4	11	41.910	119.0	36	31.50	25.00	28	6	39.50
E5471.1/4N02	1.1/4	11	41.910	119.0	36	31.50	25.00	28	6	39.50
E5471.1/4N03	1.1/4	11	41.910	119.0	36	31.50	25.00	28	6	39.50
E5471.1/2N01	1.1/2	11	47.803	125.0	37	35.50	28.00	31	6	45.00
E5471.1/2N02	1.1/2	11	47.803	125.0	37	35.50	28.00	31	6	45.00
E5471.1/2N03	1.1/2	11	47.803	125.0	37	35.50	28.00	31	6	45.00
E5472N01	2"	11	59.614	140.0	41	40.00	31.50	34	6	57.00
E5472N02	2"	11	59.614	140.0	41	40.00	31.50	34	6	57.00
E5472N03	2"	11	59.614	140.0	41	40.00	31.50	34	6	57.00

E620



HSS Straight Flute Machine Tap, Metric for Helicoil Insert, ISO Standard

General purpose straight flute machine tap for through and blind holes. Bright finish to produce more accurate and cleaner threads for Screw-Thread-Inserts. These STIs are inserted into the threaded hole, produced with this tap, to reinforce the original thread or repair damaged ones.

	ISO DORMER	6H
	1.5×D	HSS
C 2-3		
Bright		

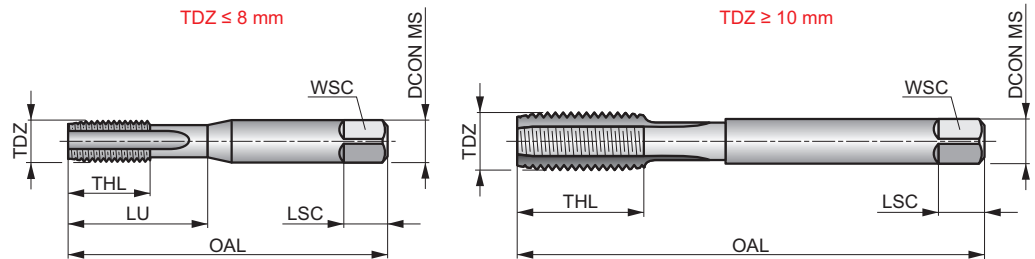

Workpiece material group suitability and starting values for cutting speed (m/min).

P1.1 ■7	P1.2 ■7	P1.3 ■8	P2.1 ■6	P2.2 ■5	P2.3 ▣4	P3.1 ■4	P3.2 ▣4	P4.1 ▣3	K1.1 ▣12	K1.2 ▣9	K1.3 ▣7	K2.1 ▣12	K2.2 ▣10
K3.1 ▣11	K3.2 ▣8	K4.1 ▣10	K4.2 ▣8	K5.1 ▣11	K5.2 ▣9	N1.3 ▣8	N2.1 ▣11	N2.2 ▣10	N2.3 ▣7	N3.1 ■17	N3.2 ■10	N3.3 ▣5	N4.2 ▣5
N4.3 ▣3													

Product	TDZ	TP	TD	OAL	THL	DCON MS	WSC	LSC	NOF	PHD	LU
		(mm)	(mm)	(mm)	(mm)	(mm)	(mm)	(mm)		(mm)	(mm)
E620M3	3	0.50	3.650	53.0	14	4.00	3.15	6	3	3.20	14.00
E620M4	4	0.70	4.910	58.0	11	5.00	4.00	7	3	4.20	20.00
E620M5	5	0.80	6.040	66.0	13	6.30	5.00	8	3	5.20	26.00
E620M6	6	1.00	7.300	72.0	16	8.00	6.30	9	3	6.30	29.00
E620M8	8	1.25	9.620	80.0	18	10.00	8.00	11	3	8.40	32.00
E620M10	10	1.50	11.950	89.0	22	9.00	7.10	10	3	10.50	–
E620M12	12	1.75	14.270	95.0	24	11.20	9.00	12	4	12.50	–
E620M14	14	2.00	16.600	112.0	29	14.00	11.20	14	4	14.50	–
E620M16	16	2.00	18.600	112.0	29	14.00	11.20	14	4	16.50	–

E621



HSS Spiral Flute Machine Tap, Metric for Helicoil Insert, ISO Standard

Machine tap with spiral flute suited for blind holes. Bright finish to produce more accurate and cleaner threads for Screw-Thread-Inserts. These STIs are inserted into the threaded hole, produced with this tap, to reinforce the original thread or repair damaged ones.

		6H
	2xD	HSS
C 2-3		λ 40°
	Bright	

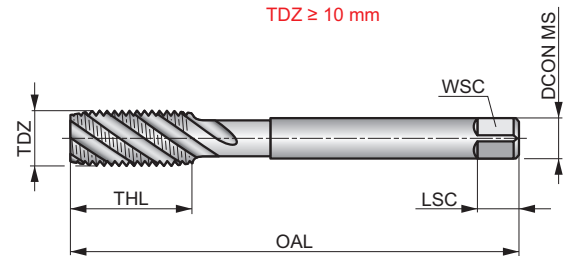
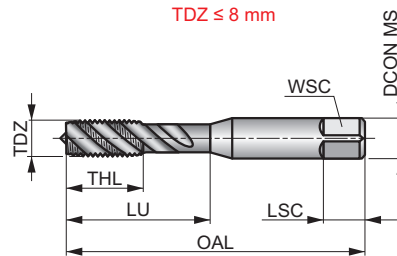

Workpiece material group suitability and starting values for cutting speed (m/min).

P1.1 ■ 10	P1.2 ■ 11	P1.3 ■ 13	P2.1 ■ 8	P2.2 ■ 7	P2.3 ▣ 6	P3.1 ■ 7	P3.2 ▣ 5	P4.1 ▣ 4	N1.3 ▣ 5	N2.1 ▣ 12	N2.2 ▣ 10	N2.3 ▣ 8
---------------------	---------------------	---------------------	--------------------	--------------------	--------------------	--------------------	--------------------	--------------------	--------------------	---------------------	---------------------	--------------------

Product	TDZ	TP	TD	OAL	THL	DCON MS	WSC	LSC	NOF	PHD	LU
		(mm)	(mm)	(mm)	(mm)		(mm)	(mm)		(mm)	(mm)
E621M3	3	0.50	3.650	53.0	14	4.00	3.15	6	3	3.20	14.00
E621M4	4	0.70	4.910	58.0	11	5.00	4.00	7	3	4.20	20.00
E621M5	5	0.80	6.040	66.0	13	6.30	5.00	8	3	5.20	26.00
E621M6	6	1.00	7.300	72.0	16	8.00	6.30	9	3	6.30	31.00
E621M8	8	1.25	9.620	80.0	18	10.00	8.00	11	3	8.40	34.00
E621M10	10	1.50	11.950	89.0	22	9.00	7.10	10	3	10.50	–
E621M12	12	1.75	14.270	95.0	24	11.20	9.00	12	3	12.50	–
E621M14	14	2.00	16.600	112.0	29	14.00	11.20	14	3	14.50	–
E621M16	16	2.00	18.600	112.0	29	14.00	11.20	14	3	16.50	–

E650



HSS Drill-Tap Combination Tool with 30° Spiral Flute, Metric, ISO Standard

Combination of a core-hole drill and tap to produce a thread in one pass. This significantly reduces the time needed to produce the thread on site with the use of a hand-held power tool. There is no need for a tap wrench or tool change. Steam tempered surface acts to retain the lubricant and provide smoother cutting.

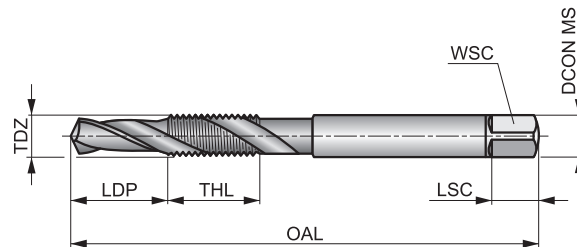

Workpiece material group suitability and starting values for cutting speed (m/min).

Product	TDZ	TP	TD	OAL	THL	LDP	DCON MS	WSC	LSC	NOF	Workpiece material group suitability and starting values for cutting speed (m/min)												
											P1.1	P1.2	P1.3	P2.1	P2.2	P3.1	P3.2	N1.2	N1.3	N3.1	N3.2	N4.1	
E650M3	3	0.50	2.500	56.0	10	6.00	3.15	2.50	5	2	■ 18	■ 20	■ 22	■ 20	▣ 18	▣ 15	▣ 12	▣ 14	▣ 9	▣ 20	▣ 15	▣ 25	
E650M4	4	0.70	3.300	65.0	12	8.00	4.00	3.15	6	2													
E650M5	5	0.80	4.200	69.0	15	10.00	5.00	4.00	7	2													
E650M6	6	1.00	5.000	84.0	18	12.00	6.30	5.00	8	2													
E650M8	8	1.25	6.800	96.0	21	16.00	8.00	6.30	9	2													
E650M10	10	1.50	8.500	108.0	22	20.00	10.00	8.00	11	2													
E650M12	12	1.75	10.200	113.0	29	24.00	9.00	7.10	10	2													
E650M14	14	2.00	12.000	123.0	30	28.00	11.20	9.00	12	2													
E650M16	16	2.00	14.000	134.0	32	32.00	12.50	10.00	13	2													

E651



HSS Drill-Tap Combination Tool with 30° Spiral Flute, UNC, DIN Standard

Combination of a core-hole drill and tap to produce a thread in one pass. This significantly reduces the time needed to produce the thread on site with the use of a hand-held power tool. There is no need for a tap wrench or tool change. Steam tempered surface acts to retain the lubricant and provide smoother cutting.

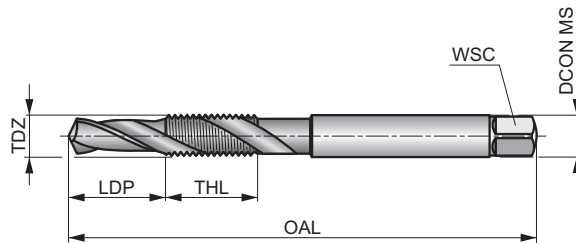

		2B
	1.5xD	HSS
C 2-3		λ 30°

Workpiece material group suitability and starting values for cutting speed (m/min).

P1.1 ■ 18	P1.2 ■ 20	P1.3 ■ 22	P2.1 ■ 20	P2.2 ▣ 18	P3.1 ▣ 15	P3.2 ▣ 12	N1.2 ▣ 14	N1.3 ▣ 9	N3.1 ▣ 20	N3.2 ▣ 15	N4.1 ▣ 25
---------------------	---------------------	---------------------	---------------------	---------------------	---------------------	---------------------	---------------------	--------------------	---------------------	---------------------	---------------------

Product	TDZ	TPI	TD	OAL	THL	LDP	DCON MS	WSC	NOF
			(mm)	(mm)	(mm)	(mm)	(mm)	(mm)	
E6516-32	6	32	2.850	56.9	12	6.00	3.50	2.90	2
E6518-32	8	32	3.500	64.0	12	8.00	4.50	3.55	2
E65110-24	10	24	3.900	72.0	15	10.00	5.00	4.00	2
E65112-24	12	24	4.500	77.0	15	11.00	5.60	4.50	2
E6511/4	1/4	20	5.100	83.0	17	13.00	6.30	5.00	2
E6515/16	5/16	18	6.600	94.0	21	16.00	8.00	6.30	2
E6513/8	3/8	16	8.000	107.0	23	19.00	10.00	8.00	2
E6517/16	7/16	14	9.400	107.0	25	22.00	8.00	6.30	2
E6511/2	1/2	13	10.800	114.0	29	25.00	9.00	7.10	2
E6519/16	9/16	12	12.200	124.0	29	28.00	11.20	9.00	2
E6515/8	5/8	11	13.500	134.0	31	32.50	12.50	10.00	2

E654



HSS Drill-Tap Combination Tool with 30° Spiral Flute, UNF, DIN Standard

Combination of a core-hole drill and tap to produce a thread in one pass. This significantly reduces the time needed to produce the thread on site with the use of a hand-held power tool. There is no need for a tap wrench or tool change. Steam tempered surface acts to retain the lubricant and provide smoother cutting.

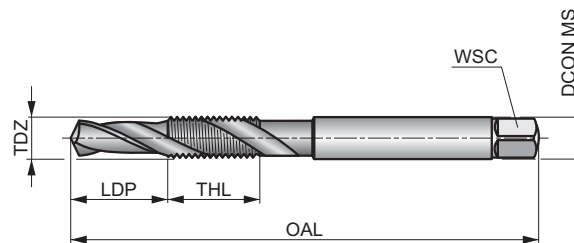

		Medium
	1.5×D	HSS
C 2-3		λ 30°

Workpiece material group suitability and starting values for cutting speed (m/min).

P1.1 ■ 18	P1.2 ■ 20	P1.3 ■ 22	P2.1 ■ 20	P2.2 ■ 18	P3.1 ■ 15	P3.2 ■ 12	N1.2 ■ 14	N1.3 ■ 9	N3.1 ■ 20	N3.2 ■ 15	N4.1 ■ 25
---------------------	---------------------	---------------------	---------------------	---------------------	---------------------	---------------------	---------------------	--------------------	---------------------	---------------------	---------------------

Product	TDZ	TPI	TD	OAL	THL	LDP	DCON MS	WSC	NOF
			(mm)	(mm)	(mm)	(mm)			
E6548-36	8	36	3.500	64.0	13	8.00	4.50	3.55	2
E65410-32	10	32	4.100	72.0	16	10.00	5.00	4.00	2
E65412-28	12	28	4.700	77.0	17	11.00	5.60	4.50	2
E6541/4	1/4	28	5.500	83.0	19	13.00	6.30	5.00	2
E6545/16	5/16	24	6.900	94.0	22	16.00	8.00	6.30	2
E6543/8	3/8	24	8.500	104.0	24	19.00	10.00	8.00	2
E6547/16	7/16	20	9.900	107.0	25	22.00	8.00	6.30	2
E6541/2	1/2	20	11.500	114.0	29	25.00	9.00	7.10	2
E6545/8	5/8	18	14.500	134.0	32	32.00	12.50	10.00	2

E653



HSS Drill-Tap Combination Tool with 27° Spiral Flute, NPT, ANSI Standard

Combination of a core-hole drill and tap to produce a thread in one pass. This significantly reduces the time needed to produce the thread on site with the use of a hand-held power tool. There is no need for a tap wrench or tool change. Steam tempered surface acts to retain the lubricant and provide smoother cutting.

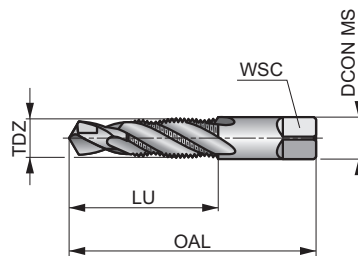

	ANSI	Normal
	1.5×D	HSS
	λ 27°	

Workpiece material group suitability and starting values for cutting speed (m/min).

Product	TDZ	TPI	TD (inch)	OAL (inch)	LU (inch)	DCON MS (inch)	WSC (inch)	NOF	Workpiece material group suitability and starting values for cutting speed (m/min)												
									P1.1	P1.2	P1.3	P2.1	P2.2	P3.1	P3.2	N1.2	N1.3	N3.1	N3.2	N4.1	
									■ 18	■ 20	■ 22	■ 20	▣ 18	▣ 15	▣ 12	▣ 14	▣ 9	▣ 20	▣ 15	▣ 25	
E6531/8	1/8	27	0.3346	2.7/8	3/4	0.4370	0.3280	2													
E6531/4	1/4	18	0.4331	3.5/16	1.1/16	0.5620	0.4210	2													
E6533/8	3/8	18	0.5709	3.1/2	1.1/16	0.7000	0.5310	2													
E6531/2	1/2	14	0.7087	4.3/8	1.3/8	0.6870	0.5150	2													
E6533/4	3/4	14	0.9055	4.9/16	1.3/8	0.9060	0.6790	2													
E6531	1"	11.5	1.1417	5.3/8	1.3/4	1.1250	0.8430	2													

L112



Tap Wrench

Adjustable, so one tap wrench can be used to hold several different tap sizes. The square end of the tap is inserted into the wrench which is then tightened to hold the tap securely. The two metal bars on either side of the wrench are used to rotate the tap in the hole of the workpiece to create the thread.

BT1-BT2

NO0-NO7

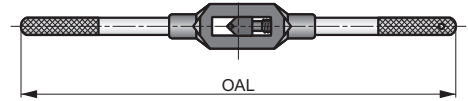

Products from this series are also available in set with taps and dies. Please see L120.

Product	Nr.	OAL	WSCN	WSCX	WSCN	WSCX	Tap Range (M)	Tap Range (Inch)
		(mm)	(mm)	(mm)	(inch)	(inch)		
L112BT1	BT1	105.0	1.00	6.50	0.0394	0.2559	M1 – M8	No. 0 – 5/16
L112BT2	BT2	162.0	1.00	10.00	0.0394	0.3937	M1 – M14	No. 0 – 5/8
L112N00	No. 0	130.0	2.00	5.00	0.0787	0.1969	M1 – M5	No. 0 – 1/4
L112N01.1/2	No. 1.1/2	205.0	2.10	8.00	0.0827	0.3150	M2.2 – M12	No. 0 – 1/2
L112N03	No. 3	380.0	4.90	12.00	0.1929	0.4724	M5 – M20	5/16 – 3/4
L112N04	No. 4	500.0	5.50	16.00	0.2165	0.6299	M7 – M30	5/16 – 1"
L112N06	No. 6	1000.0	11.00	24.00	0.4331	0.9449	M18 – M42	3/4 – 1.1/2
L112N07	No. 7	1250.0	16.00	32.00	0.6299	1.2598	M27 – M48	1.1/8 – 2"

L120



Set of Taps, Dies and Tap Wrenches, Various Sizes

Threading kit for either ISO-Metric, UNC or UNF thread. Containing sets of hand or serial hand taps, dies, tap wrenches and die stocks, all together in a smart metal case with carry handle and latch-lock fasteners.

Nr. =Set number, A=No. in Set, B=Styles in Set, C=Diameters in set.

Product	Nr.	A	B	C
L12021	21	21	E100	E100M3N08, E100M4N08, E100M5N08, E100M6N08, E100M8N08, E100M10N08, E100M12N08
			F100	F100M3, F100M4, F100M5, F100M6, F100M8, F100M10, F100M12
			L112	L112N01.1/2, L112N03
			L110	L1102A, L1102B, L1103, L1104, L1105
L12030	30	30	E100	E100M3N08, E100M4N08, E100M5N08, E100M6N08, E100M8N08, E100M10N08, E100M12N08, E100M14N08, E100M16N08, E100M18N08, E100M20N08
			F100	F100M3, F100M4, F100M5, F100M6, F100M8, F100M10, F100M12, F100M14, F100M16, F100M18, F100M20
			L112	L112N01.1/2, L112N04
			L110	L1102A, L1102B, L1103, L1104, L1105, L1106
L1202M	HS-2M	23	E500	E500M2N01, E500M2N03, E500M2.5N01, E500M2.5N03, E500M3N01, E500M3N03, E500M3.5N01, E500M3.5N03, E500M4N01, E500M4N03, E500M5N01, E500M5N03, E500M6N01, E500M6N03
			F300	F300M2X13/16, F300M2.5X13/16, F300M3X13/16, F300M3.5X13/16, F300M4X13/16, F300M5X13/16, F300M6X13/16
			L112	L112BT1
			L110	L11013/16
L1204M	HS-4M	32	E500	E500M5N01, E500M5N03, E500M6N01, E500M6N03, E500M7N01, E500M7N03, E500M8N01, E500M8N03, E500M9N01, E500M9N03, E500M10N01, E500M10N03, E500M11N01, E500M11N03, E500M12N01, E500M12N03
			F300	F300M5X13/16, F300M6X13/16, F300M7X13/16, F300M8X1.5/16, F300M9X1.5/16, F300M10X1.5/16, F300M11X1.5/16, F300M12X1.5/16, F300M5X13/16, F300M6X13/16, F300M7X13/16, F300M8X1.5/16, F300M9X1.5/16
			L112	L112BT2
			L110	L11013/16, L1101.5/16
L1208M	HS-8M	17	E500	E500M2N01, E500M2N03, E500M3N01, E500M3N03, E500M4N01, E500M4N03, E500M5N01, E500M5N03, E500M6N01, E500M6N03
			F300	F300M2X13/16, F300M3X13/16, F300M4X13/16, F300M5X13/16, F300M6X13/16
			L112	L112BT1
			L110	L11013/16
L12010M	HS-10M	27	E500	E500M3N01, E500M3N03, E500M4N01, E500M4N03, E500M5N01, E500M5N03, E500M6N01, E500M6N03, E500M7N01, E500M7N03, E500M8N01, E500M8N03, E500M9N01, E500M9N03, E500M10N01, E500M10N03
			F300	F300M3X13/16, F300M4X13/16, F300M5X13/16, F300M6X1, F300M7X1, F300M8X1, F300M9X1, F300M10X1
			L112	L112BT2
			L110	L11013/16, L1101INCH
L12012M	HS-12M	35	E500	E500M2N01, E500M2N03, E500M3N01, E500M3N03, E500M4N01, E500M4N03, E500M5N01, E500M5N03, E500M6N01, E500M6N03, E500M7N01, E500M7N03, E500M8N01, E500M8N03, E500M9N01, E500M9N03, E500M10N01, E500M10N03, E500M12N01, E500M12N03
			F300	F300M2X13/16, F300M3X13/16, F300M4X13/16, F300M5X13/16, F300M6X13/16, F300M7X13/16, F300M8X1, F300M9X1, F300M10X1, F300M12X1.5/16
			L112	L112BT1, L112BT2
			L110	L11013/16, L1101INCH, L1101.5/16
L12014M	HS-14M	34	E500	E500M6N01, E500M6N03, E500M7N01, E500M7N03, E500M8N01, E500M8N03, E500M9N01, E500M9N03, E500M10N01, E500M10N03, E500M12N01, E500M12N03, E500M14N01, E500M14N03, E500M16N01, E500M16N03, E500M18N01, E500M18N03, E500M20N01, E500M20N03
			F300	F300M6X1, F300M7X1, F300M8X1, F300M9X1, F300M10X1, F300M12X1.5/16, F300M14X1.5/16, F300M16X1.1/2, F300M18X1.1/2, F300M20X1.1/2
			L112	L112N03
			L110	L1101INCH, L1101.5/16, L1101.1/2

L115



Set of E500 Taps and A002 or A022 Drills

Shock-proof plastic box containing straight flute taps according to ISO standard with corresponding drills. Suitable for hand and machine tapping. Nr.101 with bottoming lead taps NO3 for blind holes and A002 jobber drills or Nr.100 with NO3 and NO2 plug lead taps for through holes and A022 stub drills.

Nr. =Set number, A=Styles in Set, B=No. in Set, C=Tap diameters in Set, D=Drill diameters in Set.

Product	Nr.	A	B	C	D
L115100	Nr.100	E500 + A022	21	E500M3NO2, E500M3NO3, E500M4NO2, E500M4NO3, E500M5NO2, E500M5NO3, E500M6NO2, E500M6NO3, E500M8NO2, E500M8NO3, E500M10NO2, E500M10NO3, E500M12NO2, E500M12NO3	A0222.5, A0223.3, A0224.2, A0225.0, A0226.8, A0228.5, A02210.2
L115101	Nr.101	E500 + A002	14	E500M3NO3, E500M4NO3, E500M5NO3, E500M6NO3, E500M8NO3, E500M10NO3, E500M12NO3	A0022.5, A0023.3, A0024.2, A0025.0, A0026.8, A0028.5, A00210.2

L126



HSS Drill-Taps with 30° Spiral Flute, Set of 6 pieces, Metric, ISO Standard

Metal cassette containing six drill-taps to produce threads in one pass. This significantly reduces the time needed to produce the thread on site with the use of a hand-held power tool. There is no need for a tap wrench or tool change. Steam tempered surface acts to retain the lubricant and provide smoother cutting.

Nr. =Set number, A=Styles in Set, B=No. in Set, C=Tap diameters in Set

Product	Nr.	A	B	C
L126650	Nr. 650	E650	6	E650M4, E650M5, E650M6, E650M8, E650M10, E650M12



L119



HSS Straight Flute Serial Hand Tap, Set of 21 Pieces, Metric, DIN Standard

Metal cassette containing seven sets of serial hand taps according to DIN standard. Ideal for hand tapping tough materials. The straight flute design makes it suitable for both through and blind holes. Each set of three serial taps should be used one after the other to create the full thread.

Nr. =Set number, A=Styles in Set, B=No. in Set, C=Tap diameters in Set

Product	Nr.	A	B	C
L11917	Nr.17	E100	21	E100M3N08, E100M4N08, E100M5N08, E100M6N08, E100M8N08, E100M10N08, E100M12N08

L000



DuoPack with E500 Tap and A002 Drill, Various Sizes

DuoPack containing a straight flute hand tap according to ISO standard with corresponding drill. Suitable for hand and machine tapping. Available with plug lead N02 for through holes or bottoming lead N03 for blind holes. The convenient packaging ensures the right drill size to make a perfect thread.

Nr. =Set number, A=Styles in Set, B=No. in Set, C=Tap diameters in Set, D=Drill diameters in Set.

Product	Nr.	A	B	C	D
L000E500M3N02XA002	Nr.1	E500 + A002	2	E500M3N02	A0022.5
L000E500M4N02XA002	Nr.2	E500 + A002	2	E500M4N02	A0023.3
L000E500M5N02XA002	Nr.3	E500 + A002	2	E500M5N02	A0024.2
L000E500M6N02XA002	Nr.4	E500 + A002	2	E500M6N02	A0025.0
L000E500M8N02XA002	Nr.5	E500 + A002	2	E500M8N02	A0026.8
L000E500M10N02XA002	Nr.6	E500 + A002	2	E500M10N02	A0028.5
L000E500M12N02XA002	Nr.7	E500 + A002	2	E500M12N02	A00210.2
L000E500M3N03XA002	Nr.8	E500 + A002	2	E500M3N03	A0022.5
L000E500M4N03XA002	Nr.9	E500 + A002	2	E500M4N03	A0023.3
L000E500M5N03XA002	Nr.10	E500 + A002	2	E500M5N03	A0024.2
L000E500M6N03XA002	Nr.11	E500 + A002	2	E500M6N03	A0025.0
L000E500M8N03XA002	Nr.12	E500 + A002	2	E500M8N03	A0026.8
L000E500M10N03XA002	Nr.13	E500 + A002	2	E500M10N03	A0028.5
L000E500M12N03XA002	Nr.14	E500 + A002	2	E500M12N03	A00210.2

L001



DuoPack with EP00 or EX00 Tap and A002 Drill, Various Sizes

DuoPack containing a machine tap according to DIN standard with corresponding drill. Either with a spiral point tap EP00 for through holes only or spiral flute tap EX00 for blind holes. The convenient packaging ensures the right drill size to make a perfect thread.

Nr. =Set number, A=Styles in Set, B=No. in Set, C=Tap diameters in Set, D=Drill diameters in Set.

Product	Nr.	A	B	C	D
L001EP00M3XA002	Nr.1	EP006H + A002	2	EP00M3	A0022.5
L001EP00M4XA002	Nr.2	EP006H + A002	2	EP00M4	A0023.3
L001EP00M5XA002	Nr.3	EP006H + A002	2	EP00M5	A0024.2
L001EP00M6XA002	Nr.4	EP006H + A002	2	EP00M6	A0025.0
L001EP00M8XA002	Nr.5	EP006H + A002	2	EP00M8	A0026.8
L001EP00M10XA002	Nr.6	EP006H + A002	2	EP00M10	A0028.5
L001EP00M12XA002	Nr.7	EP006H + A002	2	EP00M12	A00210.2
L001EX00M3XA002	Nr.8	EX006H + A002	2	EX00M3	A0022.5
L001EX00M4XA002	Nr.9	EX006H + A002	2	EX00M4	A0023.3
L001EX00M5XA002	Nr.10	EX006H + A002	2	EX00M5	A0024.2
L001EX00M6XA002	Nr.11	EX006H + A002	2	EX00M6	A0025.0
L001EX00M8XA002	Nr.12	EX006H + A002	2	EX00M8	A0026.8
L001EX00M10XA002	Nr.13	EX006H + A002	2	EX00M10	A0028.5
L001EX00M12XA002	Nr.14	EX006H + A002	2	EX00M12	A00210.2

L002



DuoPack with E000 or E002 Tap and A002 Drill, Various Sizes

DuoPack containing a machine tap according to ISO standard with corresponding drill. Either with a spiral point tap E000 for through holes only or spiral flute tap E002 for blind holes. The convenient packaging ensures the right drill size to make a perfect thread.

Nr. =Set number, A=Styles in Set, B=No. in Set, C=Tap diameters in Set, D=Drill diameters in Set.





Product	Nr.	A	B	C	D
L002E000M3XA002	Nr.1	E000 + A002	2	E000M3	A0022.5
L002E000M4XA002	Nr.2	E000 + A002	2	E000M4	A0023.3
L002E000M5XA002	Nr.3	E000 + A002	2	E000M5	A0024.2
L002E000M6XA002	Nr.4	E000 + A002	2	E000M6	A0025.0
L002E000M8XA002	Nr.5	E000 + A002	2	E000M8	A0026.8
L002E000M10XA002	Nr.6	E000 + A002	2	E000M10	A0028.5
L002E000M12XA002	Nr.7	E000 + A002	2	E000M12	A00210.2
L002E002M3XA002	Nr.8	E002 + A002	2	E002M3	A0022.5
L002E002M4XA002	Nr.9	E002 + A002	2	E002M4	A0023.3
L002E002M5XA002	Nr.10	E002 + A002	2	E002M5	A0024.2
L002E002M6XA002	Nr.11	E002 + A002	2	E002M6	A0025.0
L002E002M8XA002	Nr.12	E002 + A002	2	E002M8	A0026.8
L002E002M10XA002	Nr.13	E002 + A002	2	E002M10	A0028.5
L002E002M12XA002	Nr.14	E002 + A002	2	E002M12	A00210.2

An abstract technical graphic featuring a central cluster of interconnected hexagons in white, grey, and orange. The hexagons are surrounded by various geometric shapes, including circles, triangles, and lines, creating a complex, layered composition. The background is a light grey gradient with faint, larger-scale geometric patterns.

TAPS
TECHNICAL INFORMATION

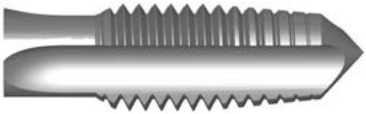

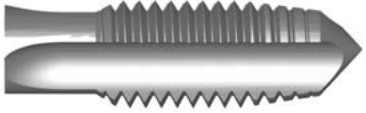
TAP NO1 – NO9 – TECHNICAL SECTION

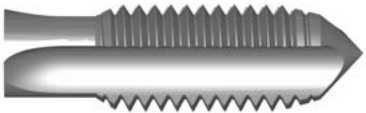
Hand taps (ISO standard) with different chamfer lengths each producing a full thread profile.

N01 =		A 6-8	
N02 =		B 4-6	
N03 =		C 2-3	
ISO	N06 =	N01 + N02 + N03	
	N07 =	N02 + N03 *	
ANSI	N06 =	N01 (taper) + N02 (plug) + N03 (bottoming)	

* **E550, E710** N07 = N03 (truncated) + N03

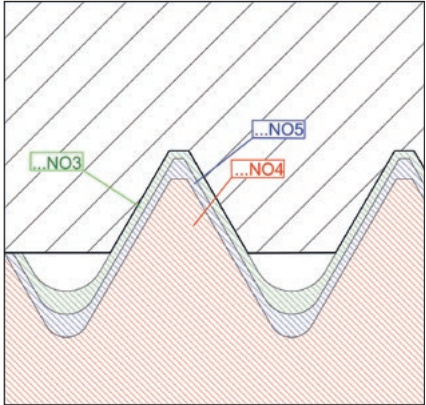
Serial taps (DIN standard) with each sequencing tap cutting a part of the profile, the N03 tap is needed to complete a full thread profile.

N04 =		A 6-8	
N05 =		B 3.5-5	
N03 =		C 2-3	
DIN ISO	N08 =	N03 + N04 + N05	
	N09 =	N03 + N05	

DIES

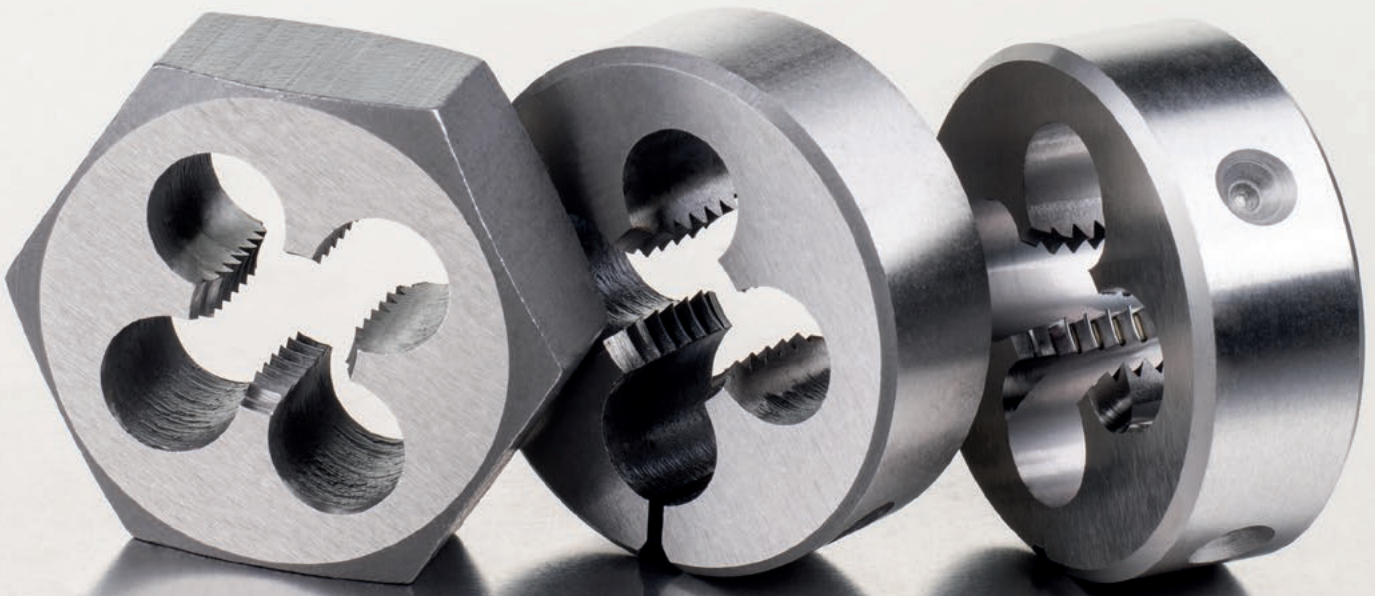



1 F310



HSS Adjustable Split Hand Die, Metric Fine, Right Hand

Split die to produce external thread by hand in multiple passes, adjustable in each pass. By tightening the die stock holder, different classes of thread fit can be achieved - tight, regular or loose fit. Slightly tightened in the holder, it can be used to clean up or produce a partial thread.

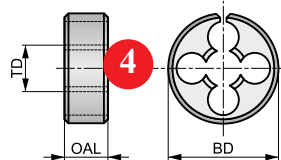

MF BS 1.75 XP
1127:1950
HSS R Bright

Workpiece material group suitability and starting values for cutting speed (m/min).

P1.1	P1.2	P1.3	P2.1	P2.2	P2.3	P3.1	P3.2	P4.1	M1.1	M1.2	M2.1	M2.2	K1.1
12	13	14	10	9	8	9	7	5	7	6	6	5	11
K1.2	K1.3	K2.1	K2.2	K2.3	K3.1	K3.2	K3.3	K5.1	K5.2	K5.3	N1.1	N1.2	N1.3
8	6	11	9	7	10	8	6	10	8	6	20	15	10
N2.1	N2.2	N2.3	N3.1	N3.2	N3.3	N4.1	N4.2	N4.3					
10	9	6	11	6	3	11	4	4					

Product	TD	TP	BD	OAL
	(mm)	(mm)	(inch)	(inch)
F310M3X.35X13/16	3.000	0.35	13/16	1/4
F310M4X.5X13/16	4.000	0.50	13/16	1/4
F310M4X.75X13/16	4.000	0.75	13/16	1/4
F310M5X.5X13/16	5.000	0.50	13/16	1/4
F310M5X.9X13/16	5.000	0.90	13/16	1/4
F310M6X.75X13/16	6.000	0.75	13/16	1/4
F310M8X.75X1	8.000	0.75	1"	3/8
F310M8X1.0X1	8.000	1.00	1"	3/8
F310M9X1.0X1	9.000	1.00	1"	3/8
F310M10X.75X1	10.000	0.75	1"	3/8
F310M10X1.0X1	10.000	1.00	1"	3/8
F310M10X1.25X1	10.000	1.25	1"	3/8

Product	TD	TP	BD	OAL
	(mm)	(mm)	(inch)	(inch)
F310M12X1.5X1.5/16	12.000	1.50	1.5/16	7/16
F310M14X1.25X1.5/16	14.000	1.25	1.5/16	7/16
F310M14X1.5X1.5/16	14.000	1.50	1.5/16	7/16
F310M16X1.0X1.1/2	16.000	1.00	1.1/2	1/2
F310M16X1.5X1.1/2	16.000	1.50	1.1/2	1/2
F310M18X1.5X1.1/2	18.000	1.50	1.1/2	1/2
F310M20X1.0X1.1/2	20.000	1.00	1.1/2	1/2
F310M20X1.5X2	20.000	1.50	2"	5/8
F310M20X2.0X1.1/2	20.000	2.00	1.1/2	1/2
F310M22X1.5X2	22.000	1.50	2"	5/8
F310M24X1.5X2	24.000	1.50	2"	5/8
F310M24X2.0X2	24.000	2.00	2"	5/8

Pos.	Description
1	Designation of dies
2	Product description
3	Illustrative picture
4	Schematic drawing of tool

Pos.	Description
5	Product features
6	Material group recommendations incl. speed and feed guidance
7	Product code
8	Product dimensions



HSS DIES – ICONS OVERVIEW

General Icons

	Primary use
	Possible use

Basic Standard Group (BSG)

	BS 1127:1950 – Round Dies Standards
	DIN 382 – Hex Die Standards

Material Code (BMC)

	High Speed Steel Tool Material
--	--------------------------------

Coating

	Bright (uncoated)
--	-------------------

Die Chamfer to Pitch Ratio (DCPR)

	Die Thread Chamfer to Pitch Ratio (1.75×TP)
--	---

Hand (Cutting direction)

	Right Hand Rotation / Cutting
--	-------------------------------

Thread Form Type (THFT)

	Thread Form, British Standard Pipe		Thread Form, Metric Fine		Thread Form, Unified Fine
	Thread Form, Metric Coarse		Thread Form, Unified Coarse		

Thread Tolerance Class (TCTR)

	Thread Tolerance Class (TCTR)		Medium Inch Thread Class of Fit
--	-------------------------------	--	---------------------------------



HSS DIES – TOOL MATERIAL NAVIGATOR

Tool materials

High Speed Steel		A medium-alloyed high speed steel that has good machinability and good performance. HSS exhibits hardness, toughness and wear resistance characteristics that make it attractive in a wide range of applications, for example in drills and taps.
-------------------------	---	---

Surface Coatings

Bright (uncoated)		Bright finish (uncoated surface) improves chip flow in soft or non-ferrous materials and maintains sharp cutting edges in abrasive materials.
--------------------------	---	---

Thread form (THFT)						
Basic standard group (BSG)	BS 1127:1950	BS 1127:1950	BS 1127:1950	BS 1127:1950	BS 1127:1950	DIN 382
Thread tolerance class (TCTR)						6G
Die chamfer to pitch ratio (DCPR)	1.75 XP	1.75 XP	1.75 XP	1.75 XP	1.75 XP	1.75 XP
Material code (BMC)	HSS	HSS	HSS	HSS	HSS	HSS
Hand (Cutting direction)						
Coating						
Product Family Code	F300	F310	F320	F330	F370	F202
	M2 - M36	M3 - M30	No.4 - 1.1/4	No.4 - 1.1/2	1/8 - 1.1/2	M3 - M36
	196	197	198	199	200	201
P	P1	■	■	■	■	■
	P2	■	■	■	■	■
	P3	▣	▣	▣	▣	▣
	P4	▣	▣	▣	▣	▣
M	M1	■	■	■	■	■
	M2	▣	▣	▣	▣	▣
	M3					
	M4					
K	K1	■	■	■	■	■
	K2	■	■	■	■	■
	K3	■	■	■	■	■
	K4					
	K5	■	■	■	■	■
N	N1	▣	▣	▣	▣	▣
	N2	▣	▣	▣	▣	▣
	N3	▣	▣	▣	▣	▣
	N4	▣	▣	▣	▣	▣
	N5					
S	S1					
	S2					
	S3					
	S4					
H	H1					
	H2					
	H3					
	H4					

■ Primary use ▣ Possible use



F302	F312	F272	L110					
------	------	------	------	--	--	--	--	--

M3 - M36	M8 - M24	1/8 - 1.1/2	16.00 - 4"					
----------	----------	-------------	------------	--	--	--	--	--

202	203	204	205					
-----	-----	-----	-----	--	--	--	--	--

P1	■	■	■					
P2	■	■	■					
P3	☑	☑	☑					
P4	☑	☑	☑					
M1	■	■	■					
M2	☑	☑	☑					
M3								
M4								
K1	■	■	■					
K2	■	■	■					
K3	■	■	■					
K4								
K5	■	■	■					
N1	☑	☑	☑					
N2	☑	☑	☑					
N3	☑	☑	☑					
N4	☑	☑	☑					
N5								
S1								
S2								
S3								
S4								
H1								
H2								
H3								
H4								

F300



HSS Adjustable Split Hand Die, Metric, Right Hand

Split die to produce external thread by hand in multiple passes, adjusting each pass. By tightening the die stock holder, different classes of thread fit can be achieved - tight, regular or loose fit. Slightly tightened in the holder, it can be used to clean up or produce a partial thread.

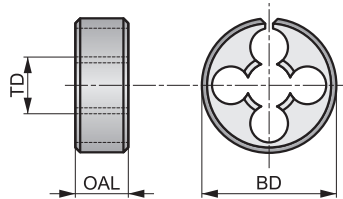

	BS 1127:1950	1.75 XP
HSS		Bright

Workpiece material group suitability and starting values for cutting speed (m/min).

P1.1 ■ 12	P1.2 ■ 13	P1.3 ■ 14	P2.1 ■ 10	P2.2 ■ 9	P2.3 ▣ 8	P3.1 ■ 8	P3.2 ▣ 7	P4.1 ▣ 5	M1.1 ■ 7	M1.2 ■ 6	M2.1 ■ 6	M2.2 ▣ 5	K1.1 ■ 11
K1.2 ■ 8	K1.3 ▣ 6	K2.1 ■ 11	K2.2 ■ 9	K2.3 ▣ 7	K3.1 ■ 10	K3.2 ■ 8	K3.3 ▣ 6	K5.1 ■ 10	K5.2 ■ 8	K5.3 ▣ 6	N1.1 ▣ 20	N1.2 ▣ 15	N1.3 ▣ 10
N2.1 ▣ 10	N2.2 ▣ 9	N2.3 ▣ 6	N3.1 ■ 11	N3.2 ▣ 6	N3.3 ▣ 3	N4.1 ▣ 11	N4.2 ▣ 4	N4.3 ▣ 4					

Products from this series are also available in set with taps. Please see L120.

Product	TD	TP	BD	OAL
	(mm)	(mm)	(inch)	(inch)
F300M2X13/16	2.000	0.40	13/16	1/4
F300M2.5X13/16	2.500	0.45	13/16	1/4
F300M3X13/16	3.000	0.50	13/16	1/4
F300M3.5X13/16	3.500	0.60	13/16	1/4
F300M4X13/16	4.000	0.70	13/16	1/4
F300M5X13/16	5.000	0.80	13/16	1/4
F300M5X1	5.000	0.80	1"	3/8
F300M6X13/16	6.000	1.00	13/16	1/4
F300M6X1	6.000	1.00	1"	3/8
F300M6X1.5/16	6.000	1.00	1.5/16	7/16
F300M7X13/16	7.000	1.00	13/16	1/4
F300M7X1	7.000	1.00	1"	3/8
F300M8X1	8.000	1.25	1"	3/8
F300M8X1.5/16	8.000	1.25	1.5/16	7/16
F300M9X1	9.000	1.25	1"	3/8
F300M9X1.5/16	9.000	1.25	1.5/16	7/16
F300M10X1	10.000	1.50	1"	3/8
F300M10X1.5/16	10.000	1.50	1.5/16	7/16

Product	TD	TP	BD	OAL
	(mm)	(mm)	(inch)	(inch)
F300M10X1.1/2	10.000	1.50	1.1/2	1/2
F300M11X1.5/16	11.000	1.50	1.5/16	7/16
F300M12X1.5/16	12.000	1.75	1.5/16	7/16
F300M12X1.1/2	12.000	1.75	1.1/2	1/2
F300M14X1.5/16	14.000	2.00	1.5/16	7/16
F300M14X1.1/2	14.000	2.00	1.1/2	1/2
F300M16X1.1/2	16.000	2.00	1.1/2	1/2
F300M16X2	16.000	2.00	2"	5/8
F300M18X1.1/2	18.000	2.50	1.1/2	1/2
F300M18X2	18.000	2.50	2"	5/8
F300M20X1.1/2	20.000	2.50	1.1/2	1/2
F300M20X2	20.000	2.50	2"	5/8
F300M22X2	22.000	2.50	2"	5/8
F300M24X2	24.000	3.00	2"	5/8
F300M27X3	27.000	3.00	3"	7/8
F300M30X3	30.000	3.50	3"	7/8
F300M36X3	36.000	4.00	3"	7/8

F310



HSS Adjustable Split Hand Die, Metric Fine, Right Hand

Split die to produce external thread by hand in multiple passes, adjusting each pass. By tightening the die stock holder, different classes of thread fit can be achieved - tight, regular or loose fit. Slightly tightened in the holder, it can be used to clean up or produce a partial thread.

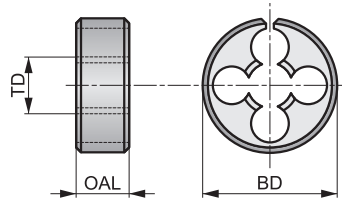

MF	BS 1127:1950	1.75 XP
HSS	R	Bright

Workpiece material group suitability and starting values for cutting speed (m/min).

P1.1 ■ 12	P1.2 ■ 13	P1.3 ■ 14	P2.1 ■ 10	P2.2 ■ 9	P2.3 ▣ 8	P3.1 ■ 8	P3.2 ▣ 7	P4.1 ▣ 5	M1.1 ■ 7	M1.2 ■ 6	M2.1 ■ 6	M2.2 ▣ 5	K1.1 ■ 11
K1.2 ■ 8	K1.3 ▣ 6	K2.1 ■ 11	K2.2 ■ 9	K2.3 ▣ 7	K3.1 ■ 10	K3.2 ■ 8	K3.3 ▣ 6	K5.1 ■ 10	K5.2 ■ 8	K5.3 ▣ 6	N1.1 ▣ 20	N1.2 ▣ 15	N1.3 ▣ 10
N2.1 ▣ 10	N2.2 ▣ 9	N2.3 ▣ 6	N3.1 ■ 11	N3.2 ▣ 6	N3.3 ▣ 3	N4.1 ▣ 11	N4.2 ▣ 4	N4.3 ▣ 4					

Product	TD (mm)	TP (mm)	BD (inch)	OAL (inch)
F310M3X.35X13/16	3.000	0.35	13/16	1/4
F310M4X.5X13/16	4.000	0.50	13/16	1/4
F310M4X.75X13/16	4.000	0.75	13/16	1/4
F310M5X.5X13/16	5.000	0.50	13/16	1/4
F310M5X.9X13/16	5.000	0.90	13/16	1/4
F310M6X.75X13/16	6.000	0.75	13/16	1/4
F310M8X.75X1	8.000	0.75	1"	3/8
F310M8X1.0X1	8.000	1.00	1"	3/8
F310M9X1.0X1	9.000	1.00	1"	3/8
F310M10X.75X1	10.000	0.75	1"	3/8
F310M10X1.0X1	10.000	1.00	1"	3/8
F310M10X1.25X1	10.000	1.25	1"	3/8
F310M10X1.25X1.5/16	10.000	1.25	1.5/16	7/16
F310M12X1.0X1.5/16	12.000	1.00	1.5/16	7/16
F310M12X1.25X1.5/16	12.000	1.25	1.5/16	7/16

Product	TD (mm)	TP (mm)	BD (inch)	OAL (inch)
F310M12X1.5X1.5/16	12.000	1.50	1.5/16	7/16
F310M14X1.25X1.5/16	14.000	1.25	1.5/16	7/16
F310M14X1.5X1.5/16	14.000	1.50	1.5/16	7/16
F310M16X1.0X1.1/2	16.000	1.00	1.1/2	1/2
F310M16X1.5X1.1/2	16.000	1.50	1.1/2	1/2
F310M18X1.5X1.1/2	18.000	1.50	1.1/2	1/2
F310M20X1.0X1.1/2	20.000	1.00	1.1/2	1/2
F310M20X1.5X2	20.000	1.50	2"	5/8
F310M20X2.0X1.1/2	20.000	2.00	1.1/2	1/2
F310M22X1.5X2	22.000	1.50	2"	5/8
F310M24X1.5X2	24.000	1.50	2"	5/8
F310M24X2.0X2	24.000	2.00	2"	5/8
F310M25X1.5X2	25.000	1.50	2"	5/8
F310M27X2.0X2.1/4	27.000	2.00	2.1/4	11/16
F310M30X2.0X2.1/4	30.000	2.00	2.1/4	11/16

F320



HSS Adjustable Split Hand Die, UNC, Right Hand

Split die to produce external thread by hand in multiple passes, adjusting each pass. By tightening the die stock holder, different classes of thread fit can be achieved - tight, regular or loose fit. Slightly tightened in the holder it can be used to clean up or produce a partial thread.

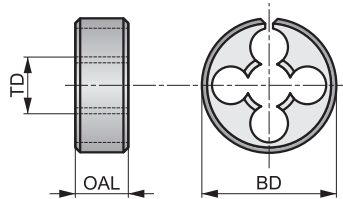

Workpiece material group suitability and starting values for cutting speed (m/min).

P1.1 ■ 12	P1.2 ■ 13	P1.3 ■ 14	P2.1 ■ 10	P2.2 ■ 9	P2.3 ▣ 8	P3.1 ■ 8	P3.2 ▣ 7	P4.1 ▣ 5	M1.1 ■ 7	M1.2 ■ 6	M2.1 ■ 6	M2.2 ▣ 5	K1.1 ■ 11
K1.2 ■ 8	K1.3 ▣ 6	K2.1 ■ 11	K2.2 ■ 9	K2.3 ▣ 7	K3.1 ■ 10	K3.2 ■ 8	K3.3 ▣ 6	K5.1 ■ 10	K5.2 ■ 8	K5.3 ▣ 6	N1.1 ▣ 20	N1.2 ▣ 15	N1.3 ▣ 10
N2.1 ▣ 10	N2.2 ▣ 9	N2.3 ▣ 6	N3.1 ■ 11	N3.2 ▣ 6	N3.3 ▣ 3	N4.1 ▣ 11	N4.2 ▣ 4	N4.3 ▣ 4					

Products from this series are also available in set with taps. Please see L120.

Product	TDZ	TPI	TD	BD	OAL
			(mm)	(inch)	(inch)
F3204-40X13/16	4	40	2.850	13/16	1/4
F3205-40X13/16	5	40	3.180	13/16	1/4
F3206-32X13/16	6	32	3.510	13/16	1/4
F3208-32X13/16	8	32	4.170	13/16	1/4
F3208-32X1	8	32	4.170	1"	3/8
F32010-24X13/16	10	24	4.830	13/16	1/4
F32010-24X1	10	24	4.830	1"	3/8
F32012-24X13/16	12	24	5.490	13/16	1/4
F3201/4X13/16	1/4	20	6.350	13/16	1/4
F3201/4X1	1/4	20	6.350	1"	3/8
F3201/4X1.5/16	1/4	20	6.350	1.5/16	7/16
F3201/4X1.1/2	1/4	20	6.350	1.1/2	1/2
F3205/16X1	5/16	18	7.940	1"	3/8
F3205/16X1.1/2	5/16	18	7.940	1.1/2	1/2
F3203/8X1	3/8	16	9.530	1"	3/8
F3203/8X1.5/16	3/8	16	9.530	1.5/16	7/16

Product	TDZ	TPI	TD	BD	OAL
			(mm)	(inch)	(inch)
F3203/8X1.1/2	3/8	16	9.530	1.1/2	1/2
F3207/16X1.5/16	7/16	14	11.110	1.5/16	7/16
F3207/16X1.1/2	7/16	14	11.110	1.1/2	1/2
F3201/2X1.5/16	1/2	13	12.700	1.5/16	7/16
F3201/2X1.1/2	1/2	13	12.700	1.1/2	1/2
F3201/2X2	1/2	13	12.700	2"	5/8
F3209/16X1.1/2	9/16	12	14.290	1.1/2	1/2
F3205/8X1.1/2	5/8	11	15.880	1.1/2	1/2
F3205/8X2	5/8	11	15.880	2"	5/8
F3203/4X1.1/2	3/4	10	19.050	1.1/2	1/2
F3203/4X2	3/4	10	19.050	2"	5/8
F3207/8X2	7/8	9	22.230	2"	5/8
F3201X2	1"	8	25.400	2"	5/8
F3201.1/8X3	1.1/8	7	28.580	3"	7/8
F3201.1/4X3	1.1/4	7	31.750	3"	7/8

F330

HSS Adjustable Split Hand Die, UNF, Right Hand

Split die to produce external thread by hand in multiple passes, adjusting each pass. By tightening the die stock holder, different classes of thread fit can be achieved - tight, regular or loose fit. Slightly tightened in the holder it can be used to clean up or produce a partial thread.

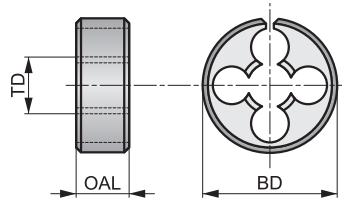

UNF	BS 1127:1950	1.75 XP
HSS	R	Bright

Workpiece material group suitability and starting values for cutting speed (m/min).

P1.1 ■ 12	P1.2 ■ 13	P1.3 ■ 14	P2.1 ■ 10	P2.2 ■ 9	P2.3 ■ 8	P3.1 ■ 8	P3.2 ■ 7	P4.1 ■ 5	M1.1 ■ 7	M1.2 ■ 6	M2.1 ■ 6	M2.2 ■ 5	K1.1 ■ 11
K1.2 ■ 8	K1.3 ■ 6	K2.1 ■ 11	K2.2 ■ 9	K2.3 ■ 7	K3.1 ■ 10	K3.2 ■ 8	K3.3 ■ 6	K5.1 ■ 10	K5.2 ■ 8	K5.3 ■ 6	N1.1 ■ 20	N1.2 ■ 15	N1.3 ■ 10
N2.1 ■ 10	N2.2 ■ 9	N2.3 ■ 6	N3.1 ■ 11	N3.2 ■ 6	N3.3 ■ 3	N4.1 ■ 11	N4.2 ■ 4	N4.3 ■ 4					

Products from this series are also available in set with taps. Please see L120.

Product	TDZ	TPI	TD	BD	OAL
			(mm)	(inch)	(inch)
F3304-48X13/16	4	48	2.850	13/16	1/4
F3305-44X13/16	5	44	3.180	13/16	1/4
F3306-40X13/16	6	40	3.510	13/16	1/4
F3308-36X13/16	8	36	4.170	13/16	1/4
F33010-32X13/16	10	32	4.830	13/16	1/4
F33010-32X1	10	32	4.830	1"	3/8
F33012-28X13/16	12	28	5.490	13/16	1/4
F3301/4X13/16	1/4	28	6.350	13/16	1/4
F3301/4X1	1/4	28	6.350	1"	3/8
F3301/4X1.1/2	1/4	28	6.350	1.1/2	1/2
F3305/16X1	5/16	24	7.940	1"	3/8
F3305/16X1.5/16	5/16	24	7.940	1.5/16	7/16
F3305/16X1.1/2	5/16	24	7.940	1.1/2	1/2
F3303/8X1	3/8	24	9.530	1"	3/8
F3303/8X1.5/16	3/8	24	9.530	1.5/16	7/16
F3303/8X1.1/2	3/8	24	9.530	1.1/2	1/2
F3307/16X1	7/16	20	11.110	1"	3/8
F3307/16X1.5/16	7/16	20	11.110	1.5/16	7/16
F3307/16X1.1/2	7/16	20	11.110	1.1/2	1/2
F3301/2X1.5/16	1/2	20	12.700	1.5/16	7/16
F3301/2X1.1/2	1/2	20	12.700	1.1/2	1/2
F3309/16X1.5/16	9/16	18	14.290	1.5/16	7/16
F3309/16X1.1/2	9/16	18	14.290	1.1/2	1/2
F3305/8X1.1/2	5/8	18	15.880	1.1/2	1/2
F3305/8X2	5/8	18	15.880	2"	5/8
F3303/4X1.1/2	3/4	16	19.050	1.1/2	1/2
F3303/4X2	3/4	16	19.050	2"	5/8
F3307/8X2	7/8	14	22.230	2"	5/8
F3301X2	1"	12	25.400	2"	5/8
F3301.1/8X3	1.1/8	12	28.580	3"	7/8
F3301.1/4X3	1.1/4	12	31.750	3"	7/8
F3301.1/2X3	1.1/2	12	38.100	3"	7/8

F370



HSS Adjustable Split Hand Die, G(BSP) Right Hand

Split die to produce external thread by hand in multiple passes, adjusting each pass. By tightening the die stock holder, different classes of thread fit can be achieved - tight, regular or loose fit. Slightly tightened in the holder it can be used to clean up or produce a partial thread.

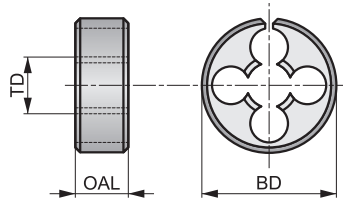

	BS 1127:1950	1.75 XP
HSS		Bright

Workpiece material group suitability and starting values for cutting speed (m/min).

P1.1 ■ 12	P1.2 ■ 13	P1.3 ■ 14	P2.1 ■ 10	P2.2 ■ 9	P2.3 ▧ 8	P3.1 ■ 8	P3.2 ▧ 7	P4.1 ▧ 5	M1.1 ■ 7	M1.2 ■ 6	M2.1 ■ 6	M2.2 ▧ 5	K1.1 ■ 11
K1.2 ■ 8	K1.3 ▧ 6	K2.1 ■ 11	K2.2 ■ 9	K2.3 ▧ 7	K3.1 ■ 10	K3.2 ■ 8	K3.3 ▧ 6	K5.1 ■ 10	K5.2 ■ 8	K5.3 ▧ 6	N1.1 ▧ 20	N1.2 ▧ 15	N1.3 ▧ 10
N2.1 ▧ 10	N2.2 ▧ 9	N2.3 ▧ 6	N3.1 ■ 11	N3.2 ▧ 6	N3.3 ▧ 3	N4.1 ▧ 11	N4.2 ▧ 4	N4.3 ▧ 4					

Product	TDZ	TPI	TD		BD		OAL	
			(mm)	(inch)	(mm)	(inch)	(mm)	(inch)
F3701/8X1	1/8	28	9.730	1"	13.160	1/2	16.660	3/8
F3701/4X1.5/16	1/4	19	13.160	1.5/16	20.960	2"	22.910	7/16
F3703/8X1.1/2	3/8	19	16.660	1.1/2	26.440	2"	26.440	1/2
F3701/2X2	1/2	14	20.960	2"	30.200	2.1/4	33.250	5/8
F3705/8X2	5/8	14	22.910	2"	33.250	2.1/4	33.250	5/8
F3703/4X2	3/4	14	26.440	2"	41.910	3"	41.910	5/8
F3707/8X2.1/4	7/8	14	30.200	2.1/4	47.800	4"	47.800	11/16
F3701X2.1/4	1"	11	33.250	2.1/4				11/16
F3701.1/4X3	1.1/4	11	41.910	3"				7/8
F3701.1/2X4	1.1/2	11	47.800	4"				1"

F202

HSS Die Nut Metric, Right Hand

Hexagon die nut designed to repair or clean out damaged external threads by re-cutting the original thread form by hand. A wrench or spanner can be used to rotate the die nut around the outside of the bolt, thus it can be used in difficult to access locations.

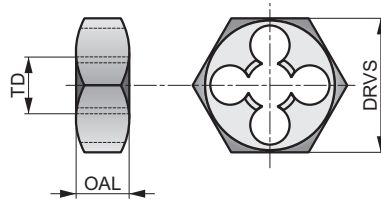

M	DIN 382	6G
1.75 XP	HSS	R
Bright		

Workpiece material group suitability and starting values for cutting speed (m/min).

P1.1 ■ 12	P1.2 ■ 13	P1.3 ■ 14	P2.1 ■ 10	P2.2 ■ 9	P2.3 ▧ 8	P3.1 ■ 8	P3.2 ▧ 7	P4.1 ▧ 5	M1.1 ■ 7	M1.2 ■ 6	M2.1 ■ 6	M2.2 ▧ 5	K1.1 ■ 11
K1.2 ■ 8	K1.3 ▧ 6	K2.1 ■ 11	K2.2 ■ 9	K2.3 ▧ 7	K3.1 ■ 10	K3.2 ■ 8	K3.3 ▧ 6	K5.1 ■ 10	K5.2 ■ 8	K5.3 ▧ 6	N1.1 ▧ 20	N1.2 ▧ 15	N1.3 ▧ 10
N2.1 ▧ 10	N2.2 ▧ 9	N2.3 ▧ 6	N3.1 ■ 11	N3.2 ▧ 6	N3.3 ▧ 3	N4.1 ▧ 11	N4.2 ▧ 4	N4.3 ▧ 4					

Product	TD	TP	DRVS	OAL
	(mm)	(mm)	(mm)	(mm)
F202M3	3.000	0.50	19.00	5.0
F202M4	4.000	0.70	19.00	5.0
F202M5	5.000	0.80	19.00	7.0
F202M6	6.000	1.00	19.00	7.0
F202M7	7.000	1.00	22.00	9.0
F202M8	8.000	1.25	22.00	9.0
F202M10	10.000	1.50	27.00	11.0
F202M12	12.000	1.75	36.00	14.0
F202M14	14.000	2.00	36.00	14.0
F202M16	16.000	2.00	41.00	18.0
F202M18	18.000	2.50	41.00	18.0
F202M20	20.000	2.50	41.00	18.0
F202M22	22.000	2.50	50.00	22.0
F202M24	24.000	3.00	50.00	22.0
F202M27	27.000	3.00	60.00	25.0
F202M30	30.000	3.50	60.00	25.0
F202M36	36.000	4.00	60.00	25.0

F302



HSS Die Nut Metric, Right Hand

Hexagon die nut designed to repair or clean out damaged external threads by re-cutting the original thread form by hand. A wrench or spanner can be used to rotate the die nut around the outside of the bolt, thus it can be used in difficult to access locations.

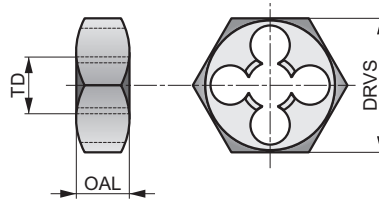

M	BS 1127-1950	6G
1.75 XP	HSS	R
Bright		

Workpiece material group suitability and starting values for cutting speed (m/min).

P1.1 ■ 12	P1.2 ■ 13	P1.3 ■ 14	P2.1 ■ 10	P2.2 ■ 9	P2.3 ▣ 8	P3.1 ■ 8	P3.2 ▣ 7	P4.1 ▣ 5	M1.1 ■ 7	M1.2 ■ 6	M2.1 ■ 6	M2.2 ▣ 5	K1.1 ■ 11
K1.2 ■ 8	K1.3 ▣ 6	K2.1 ■ 11	K2.2 ■ 9	K2.3 ▣ 7	K3.1 ■ 10	K3.2 ■ 8	K3.3 ▣ 6	K5.1 ■ 10	K5.2 ■ 8	K5.3 ▣ 6	N1.1 ▣ 20	N1.2 ▣ 15	N1.3 ▣ 10
N2.1 ▣ 10	N2.2 ▣ 9	N2.3 ▣ 6	N3.1 ■ 11	N3.2 ▣ 6	N3.3 ▣ 3	N4.1 ▣ 11	N4.2 ▣ 4	N4.3 ▣ 4					

Product	TD	TP	DRVS	OAL
	(mm)	(mm)	(inch)	(inch)
F302M3	3.000	0.50	0.7100	1/4
F302M4	4.000	0.70	0.7100	1/4
F302M5	5.000	0.80	0.7100	1/4
F302M6	6.000	1.00	0.7100	1/4
F302M7	7.000	1.00	0.8200	5/16
F302M8	8.000	1.25	0.8200	5/16
F302M10	10.000	1.50	0.9200	3/8
F302M11	11.000	1.50	1.0100	7/16
F302M12	12.000	1.75	1.1000	1/2
F302M14	14.000	2.00	1.3000	5/8
F302M16	16.000	2.00	1.3000	5/8
F302M18	18.000	2.50	1.4800	11/16
F302M20	20.000	2.50	1.4800	11/16
F302M22	22.000	2.50	1.6700	13/16
F302M24	24.000	3.00	2.0500	15/16
F302M27	27.000	3.00	2.2200	1.1/16
F302M30	30.000	3.50	2.2200	1.1/16
F302M33	33.000	3.50	2.5800	1.1/8
F302M36	36.000	4.00	2.7600	1.1/4

F312

HSS Die Nut Metric Fine, Right Hand

Hexagon die nut designed to repair or clean out damaged external threads by re-cutting the original thread form by hand. A wrench or spanner can be used to rotate the die nut around the outside of the bolt, thus it can be used in difficult to access locations.

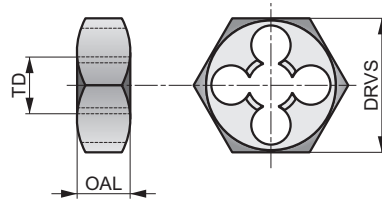

MF	BS 1127:1950	6G
1.75 XP	HSS	R
Bright		

Workpiece material group suitability and starting values for cutting speed (m/min).

P1.1 ■ 12	P1.2 ■ 13	P1.3 ■ 14	P2.1 ■ 10	P2.2 ■ 9	P2.3 ▣ 8	P3.1 ■ 8	P3.2 ▣ 7	P4.1 ▣ 5	M1.1 ■ 7	M1.2 ■ 6	M2.1 ■ 6	M2.2 ▣ 5	K1.1 ■ 11
K1.2 ■ 8	K1.3 ▣ 6	K2.1 ■ 11	K2.2 ■ 9	K2.3 ▣ 7	K3.1 ■ 10	K3.2 ■ 8	K3.3 ▣ 6	K5.1 ■ 10	K5.2 ■ 8	K5.3 ▣ 6	N1.1 ▣ 20	N1.2 ▣ 15	N1.3 ▣ 10
N2.1 ▣ 10	N2.2 ▣ 9	N2.3 ▣ 6	N3.1 ■ 11	N3.2 ▣ 6	N3.3 ▣ 3	N4.1 ▣ 11	N4.2 ▣ 4	N4.3 ▣ 4					

Product	TD	TP	DRVS	OAL
	(mm)	(mm)	(inch)	(inch)
F312M8X.75	8.000	0.75	0.8200	5/16
F312M8X1.0	8.000	1.00	0.8200	5/16
F312M10X1.0	10.000	1.00	0.9200	3/8
F312M10X1.25	10.000	1.25	0.9200	3/8
F312M12X1.0	12.000	1.00	1.0100	7/16
F312M12X1.25	12.000	1.25	1.0100	7/16
F312M12X1.5	12.000	1.50	1.0100	7/16
F312M14X1.5	14.000	1.50	1.3000	5/8
F312M16X1.5	16.000	1.50	1.3000	5/8
F312M18X1.5	18.000	1.50	1.4800	11/16
F312M20X1.5	20.000	1.50	1.4800	11/16
F312M22X1.5	22.000	1.50	1.6700	13/16
F312M24X1.5	24.000	1.50	2.0500	15/16
F312M24X2.0	24.000	2.00	2.0500	15/16

F272



HSS Die Nut G(BSP) Right Hand

Hexagon die nut designed to repair or clean out damaged external threads by re-cutting the original thread form by hand. A wrench or spanner can be used to rotate the die nut around the outside of the bolt, thus it can be used in difficult to access locations.

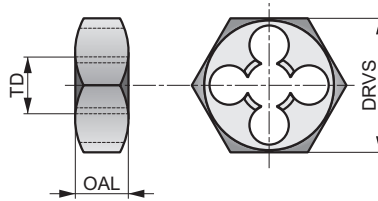

G	DIN 382	Class A
1.75 XP	HSS	R
Bright		

Workpiece material group suitability and starting values for cutting speed (m/min).

P1.1 ■ 12	P1.2 ■ 13	P1.3 ■ 14	P2.1 ■ 10	P2.2 ■ 9	P2.3 ▧ 8	P3.1 ■ 8	P3.2 ▧ 7	P4.1 ▧ 5	M1.1 ■ 7	M1.2 ■ 6	M2.1 ■ 6	M2.2 ▧ 5	K1.1 ■ 11
K1.2 ■ 8	K1.3 ▧ 6	K2.1 ■ 11	K2.2 ■ 9	K2.3 ▧ 7	K3.1 ■ 10	K3.2 ■ 8	K3.3 ▧ 6	K5.1 ■ 10	K5.2 ■ 8	K5.3 ▧ 6	N1.1 ▧ 20	N1.2 ▧ 15	N1.3 ▧ 10
N2.1 ▧ 10	N2.2 ▧ 9	N2.3 ▧ 6	N3.1 ■ 11	N3.2 ▧ 6	N3.3 ▧ 3	N4.1 ▧ 11	N4.2 ▧ 4	N4.3 ▧ 4					

Product	TDZ	TPI	TD	DRVS	OAL
			(mm)		
F2721/8	1/8	28	9.730	27.00	11.0
F2721/4	1/4	19	13.160	36.00	10.0
F2723/8	3/8	19	16.660	41.00	14.0
F2721/2	1/2	14	20.960	41.00	14.0
F2723/4	3/4	14	26.440	60.00	18.0
F2721	1"	11	33.250	60.00	18.0
F2721.1/4	1.1/4	11	41.910	70.00	20.0
F2721.1/2	1.1/2	11	47.800	85.00	22.0

L110



Die Stock

The die stock is an accessory to make it easy to use dies by hand. The die is held securely in the metal ring, whilst the arms at either end are used to rotate the die around the outside of the metal cylinder to be threaded. The L110 series comes in an extensive range to hold all sizes of round dies.

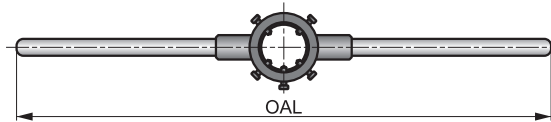

Products from this series are also available in set with taps and dies. Please see L120.

Product	Nr.	OAL (mm)	BD × OAL
L1101	1"	160.0	16 × 5
L1102A	2a	200.0	20 × 5
L1102B	2b	200.0	20 × 7
L1103	3	224.0	25 × 9
L1104	4"	280.0	30 × 11
L1105	5	315.0	38 × 14
L1105F	5f	315.0	38 × 10
L1106	6	450.0	45 × 18
L1106F	6f	450.0	45 × 14
L1107	7	560.0	55 × 22
L1107F	7f	560.0	55 × 16
L1108	8	630.0	65 × 25
L1108F	8f	630.0	65 × 18
L1109	9	800.0	75 × 30
L1109F	9f	800.0	75 × 20
L11010	10	900.0	90 × 36
L11010F	10f	900.0	90 × 22
L11013/16	–	200.0	13/16 × 1/4
L1101INCH	–	224.0	1 × 3/8
L1101.5/16	–	270.0	1.5/16 × 7/16
L1101.1/2	–	315.0	1.1/2 × 1/2
L1102INCH	–	560.0	2 × 5/8
L1102.1/4	–	560.0	2.1/4 × 11/16
L1103INCH	–	900.0	3 × 7/8
L1104INCH	–	1000.0	4 × 1

Nomenclature

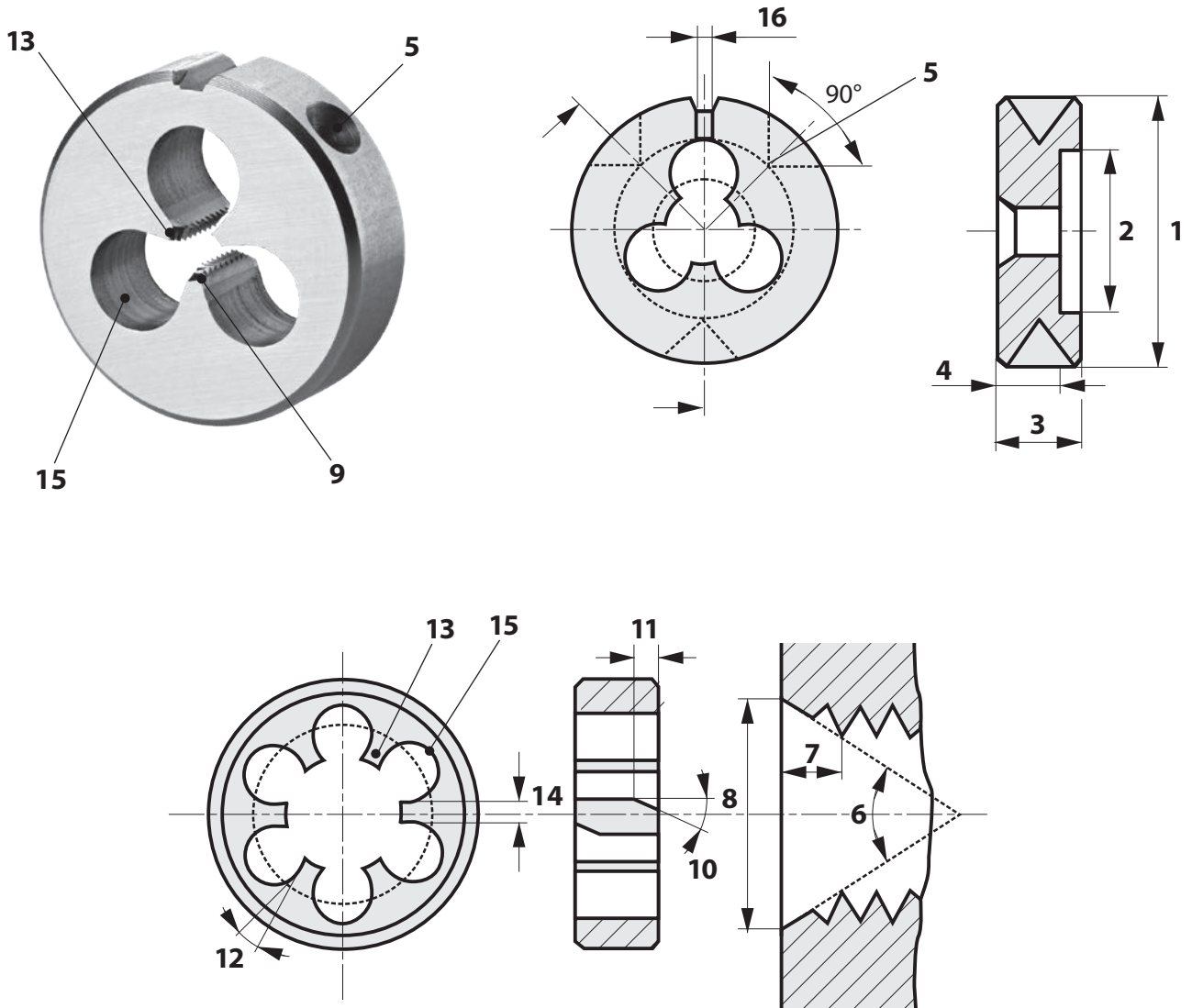

1	Outside Diameter
2	Recess Diameter
3	Thickness
4	Thread Length
5	Conical Hole for Fixing Screw
6	Chamfer Angle
7	Chamfer Length
8	Chamfer Diameter

9	Gun-nose
10	Spiral Angle
11	Spiral Length
12	Rake Angle
13	Land
14	Width of Land
15	Clearance Hole
16	Split of Adjustment

Technical Tips on Threading with Dies

1. Before starting the die or dienut, chamfer the end of the bar at an angle of 45 degrees to eliminate sudden loading of the leading edges. Ensure the die or dienut is presented to the bolt squarely.
2. Make use of the large tolerances associated with the major diameter of the bolt, by reducing the diameter of the bar (see below). This will reduce the cutting force to a minimum.
3. Use the gun nose type of die, as this ensures the chips are directed away from the cutting area.
4. Ensure a good supply of the correct lubricant is aimed at the cutting area.
5. When adjusting split dies, avoid opening out as this will cause rubbing. Split dies may be closed down by approximately 0.15 mm, by turning the adjustment screws equally. Pressure on one side of the die only may cause breakage.
6. Generally speaking, dienuts are used for reclaiming or cleaning out existing threads by hand. They tend to be of a more robust construction and should only be used in exceptional circumstances to cut a thread from solid.

Pre-machining Dimensions

The diameter of the bolt blank must be smaller than the max. external diameter of the screw thread.

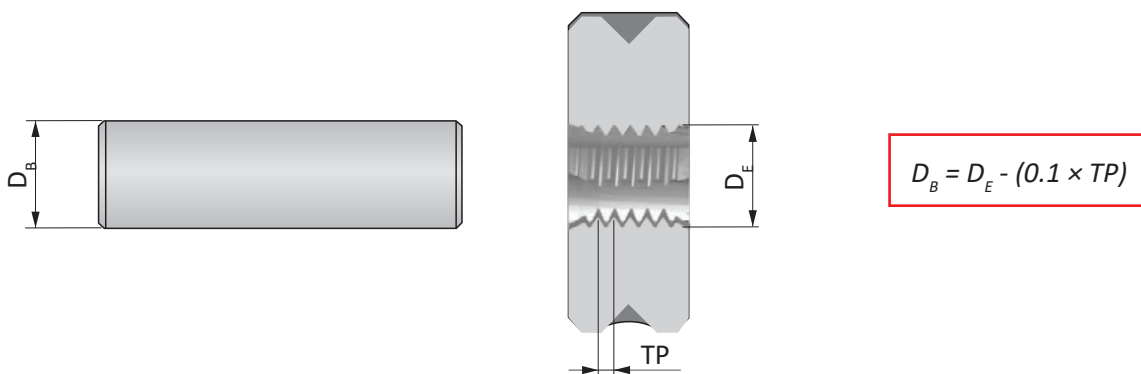

Trouble Shooting When Threading With Dies

Problem	Cause	Solution
Oversize/Undersize	Misalignment	Correct alignment, ensure cleanliness
	Incorrect axial feed rate	Ensure axial feed rate is controlled accurately
Poor finish	Incorrect rake angle for the material	Try alternative dies or special die
	Incorrect/lack of lubricant	See lubricants section
	Incorrect speed	Follow recommendations in Catalogue
	Bar diameter too large	Reduce to appropriate size
	Bar end not chamfered	Ensure bar end is chamfered
Chipping/Breakage	Wrong type of die	Follow recommendations in Catalogue
	Speed too high	Follow recommendations in Catalogue
	Bar diameter too large	Reduce to appropriate size
	Bar end not chamfered	Ensure bar end is chamfered
	Misalignment	Correct alignment, ensure cleanliness
Rapid wear	Incorrect/lack of lubricant	See lubricants section
	Speed too high	Follow recommendations in Catalogue
Built up edge	Incorrect/lack of lubricant	See section lubricants
	Bar diameter too large	Reduce to appropriate size
	Speed too low	Follow recommendations in Catalogue

**SOLID
HM & HSS MILLS**



1 C110



Solid Carbide Jobber Drill, Bright Finish

Improved wear resistance for increased productivity and extended tool life. A 120°, 4-facet point helps with self-centering and reduces cutting forces. Can be used with all CNC machine applications.

2

HSS-E PM	N	NOF 2
	λ 30°	γ 12°
DIN 1835B	Bright	DC e8
	DIN 327D	

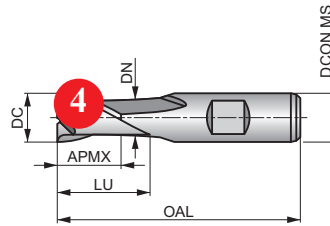

Workpiece material group suitability, starting values for cutting speed (m/min) and feed Alpha Code. Tables with feed per revolution can be found starting from page 240.

P1.1 ■ 53 E	P1.2 ■ 59 E	P1.3 ■ 61 E	P2.1 ■ 45 E	P2.2 ■ 40 E	P3.1 ■ 37 E	P3.2 ■ 30 D	P4.1 ■ 22 D	M1.1 ■ 41 E	M1.2 ■ 35 E	M2.1 ■ 37 E	M2.2 ■ 30 D	K1.1 ■ 35 E	K1.2 ■ 26 E
K1.3 ■ 19 E	K2.1 ■ 62 E	K2.2 ■ 50 E	K2.3 ■ 40 D	K3.1 ■ 54 E	K3.2 ■ 42 E	K3.3 ■ 34 D	K4.1 ■ 50 D	K4.2 ■ 38 D	K4.3 ■ 28 D	K4.4 ■ 24 C	K4.5 ■ 20 C	K5.1 ■ 57 D	K5.2 ■ 43 D
K5.3 ■ 33 D	N1.1 ■ 95 G	N1.2 ■ 71 F	N1.3 ■ 48 F	N2.1 ■ 48 E	N2.2 ■ 43 E	N2.3 ■ 31 E	N3.1 ■ 50 E	N3.2 ■ 29 E	N3.3 ■ 15 E	N4.1 ■ 50 E	S1.1 ■ 35 D	S1.2 ■ 25 D	S2.1 ■ 20 C
S3.1 ■ 15 C	S4.1 ■ 12 C												

DCON MS tolerance h6.

Product	DC (inch)	DC (mm)	DCON MS (mm)	APMX (mm)	OAL (mm)	NOF	LU (mm)	DN (mm)
8 C110.0	–	1.00	6.00	2.50	47.0	2	–	–
C1101.5	–	1.50	6.00	3.00	47.0	2	–	–
C1101/16	1/16	1.59	6.00	3.00	47.0	2	–	–
C1101.8	–	1.80	6.00	4.00	48.0	2	–	–
C1102.0	–	2.00	6.00	4.00	48.0	2	–	–
C1103/32	3/32	2.38	6.00	5.00	49.0	2	–	–
C1102.5	–	2.50	6.00	5.00	49.0	2	–	–
C1102.8	–	2.80	6.00	5.00	49.0	2	–	–
C1103.0	–	3.00	6.00	5.00	49.0	2	–	–
C1101/8	1/8	3.18	6.00	6.00	50.0	2	–	–
C1103.5	–	3.50	6.00	6.00	50.0	2	–	–
C1103.8	–	3.80	6.00	7.00	51.0	2	–	–
C1104.0	–	4.00	6.00	7.00	51.0	2	–	–
C1104.5	–	4.50	6.00	7.00	51.0	2	–	–
C1103/16	3/16	4.76	6.00	8.00	52.0	2	–	–
C1104.8 ²⁾	–	4.80	6.00	8.00	52.0	2	–	–
C1105.0	–	5.00	6.00	8.00	52.0	2	–	–
C1105.5	–	5.50	6.00	8.00	52.0	2	–	–
C1105.75 ²⁾	–	5.75	6.00	8.00	52.0	2	–	–
C1106.0	–	6.00	6.00	8.00	52.0	2	–	–
C1101/4	1/4	6.35	10.00	10.00	60.0	2	–	–
C1106.5	–	6.50	10.00	10.00	60.0	2	–	–
C1107.0	–	7.00	10.00	10.00	60.0	2	–	–
C1107.5	–	7.50	10.00	10.00	60.0	2	–	–
C1107.75 ²⁾	–	7.75	10.00	11.00	61.0	2	–	–



SOLID MILLS – PAGE OVERVIEW



Pos.	Description	Pos.	Description
1	Designation of solid mills	6	Milling operations
2	Product description	7	Material group recommendations incl. speed and feed guidance
3	Illustrative picture	8	Product code
4	Schematic drawing of tool	9	Product dimensions
5	Product features		

SOLID HM & HSS MILLS – ICONS OVERVIEW

General icons

	Primary use
	Possible use





Material code (BMC)

 HM	Hard Material (Solid Carbide)	 HSS-E PM	High Speed Cobalt Powder Metal Tool Material	 HSS-E	High Speed Cobalt Steel Tool Material
---	-------------------------------	---	--	--	---------------------------------------

Mill Profile

 N	General Purpose Cutter Type for Low to High Resistance Materials	 NF	Coarse Pitch Flat Profile Chipbreaker	 NRA	Coarse Pitch Asymmetrical Rounded Profile Chipbreaker
--	--	---	---------------------------------------	--	---

Number of flutes (NOF)

 NOF 2	Number of Flutes = 2 (teeth)	 NOF 4	Number of Flutes = 4 (teeth)	 NOF 4-8	Number of Flutes = 4 – 8 (teeth)
 NOF 3	Number of Flutes = 3 (teeth)	 NOF 4-6	Number of Flutes = 4 – 6 (teeth)		

Cut length

	Cut Length, Extra Short		Cut Length, Medium
	Cut Length, Short		Cut Length, Long

Flute Helix (FHA)

 30°	30° Helix Angle (Flute)	 35°	35° Helix Angle (Flute)
--	-------------------------	--	-------------------------

Radial rake angle (GAMF)

 12°	12° Radial Rake Angle (cutting)
---	---------------------------------

Shank

 DIN 1835B	DIN 1835B Weldon Shank	 DIN 6535HA	DIN 6535 HA Cylindrical Shank	 DIN 6535HB	DIN 6535 HB Weldon Shank
--	------------------------	---	-------------------------------	---	--------------------------

SOLID HM & HSS MILLS – ICONS OVERVIEW

Coating



Bright (uncoated)



Titanium Aluminium Nitride Coating

Cutting Diameter Tolerance Class (TCDC)



e8 – Industry Standard Tool Tolerance Zone (based on diameter range)



h12 – Industry Standard Tool Tolerance Zone (based on diameter range)



k12 – Industry Standard Tool Tolerance Zone (based on diameter range)



h10 – Industry Standard Tool Tolerance Zone (based on diameter range)



k10 – Industry Standard Tool Tolerance Zone (based on diameter range)

Cutting Direction



Radial



Radial, Diagonal



Radial, Diagonal, Axial

Basic Standard Group (BSG)



DIN 327 D – Slot Drill Standards



DIN 844 L – HSS End Mills Standards



DORMER Standards



DIN 844 K – End Mill Standards

Operations Milling



Deep Shoulder Milling



P9 Slotting (Keyway)



Progressive Plunging



Deep Slot Milling



Ramping



Drilling



Shallow Slot Milling



Plunge Milling



Helical Interpolation



Shallow Shoulder Milling

SOLID HM MILLS – TOOL MATERIALS AND SURFACE COATINGS NAVIGATOR

HM materials

Carbide Materials (or Hard Materials)		<p>A sintered powder metallurgy substrate, consisting of a metallic carbide composite with binder metal. The most central raw material is tungsten carbide (WC). Tungsten carbide contributes to the hardness of the material. Tantalum carbide (TaC), titanium carbide (TiC) and niobium carbide (NbC) complements WC and adjusts the properties to what is desired. These three materials are called cubic carbides. Cobalt (Co) acts as a binder and keeps the material together.</p> <p>Carbide materials are often characterised by high compression strength, high hardness and therefore high wear resistance, but also by limited flexural strength and toughness. Carbide is used in taps, reamers, milling cutters, drills and thread milling cutters.</p>
--	---	--

Surface Treatments



Bright (uncoated)		<p>Bright finish (uncoated surface) improves chip flow in soft or non-ferrous materials and maintains sharp cutting edges in abrasive materials.</p>
--------------------------	---	--

Surface Coatings

Titanium Aluminium Nitride Coating (TiAlN)		<p>Titanium Aluminium Nitride is a multi layer ceramic coating applied by PVD coating technology, which exhibits high toughness and oxidation stability. These properties make it ideal for higher speeds and feeds, while at the same time improving tool life. TiAlN is used in drilling, tapping, and milling applications and can be suitable for use when machining without coolant.</p>
---	---	---

SOLID HSS MILLS – TOOL MATERIALS NAVIGATOR

Tool materials

Cobalt High Speed Steel		<p>This high speed steel contains cobalt for increased hot hardness. The composition of HSCo is a good combination of toughness and hardness. It has good machinability and good wear resistance, which makes it usable for drills, taps, milling cutters and reamers.</p>
Cobalt Powder Metallurgy Steel		<p>Sintered Cobalt High Speed Steel (HSCo powder metal) is a substrate produced using powder metallurgy technology. Tools using substrates produced by this method exhibit superior toughness and grindability.</p>

SOLID HSS MILLS – SURFACE TREATMENTS AND COATINGS NAVIGATOR

Surface Treatments

Bright (uncoated)		<p>Bright finish (uncoated surface) improves chip flow in soft or non-ferrous materials and maintains sharp cutting edges in abrasive materials.</p>
--------------------------	---	--



Material code (BMC)	HSS-E PM	HSS-E PM	HSS-E PM	HSS-E PM	HSS-E PM	HSS-E PM	HSS-E PM	HSS-E	HSS-E	HM	HM	HM	HM
Mill Profile	N	N	N	N	N	N	NRA	NF	NF	N	N	N	N
Number of flutes (NOF)	NOF 2	NOF 2	NOF 3	NOF 3	NOF 4-8	NOF 4-6	NOF 4	NOF 4	NOF 4-6	NOF 2	NOF 2	NOF 3	NOF 3
Cut length													
Flute Helix (FHA)	λ 30°	λ 30°	λ 30°	λ 30°	λ 30°	λ 30°	λ 35°	λ 30°	λ 30°	λ 30°	λ 30°	λ 30°	λ 30°
Radial rake angle (GAMF)	γ 12°	γ 12°	γ 12°	γ 12°	γ 12°	γ 12°	γ 12°	γ 12°	γ 12°	γ 12°	γ 12°	γ 12°	γ 12°
Shank	 DIN 1835B	 DIN 1835B	 DIN 1835B	 DIN 1835B	 DIN 1835B	 DIN 1835B	 DIN 1835B	 DIN 1835B	 DIN 1835B	 DIN 6535HA	 DIN 6535HB	 DIN 6535HA	 DIN 6535HB
Coating	Bright	Bright	Bright	Bright	Bright	Bright	Bright	Bright	Bright	Bright	TIAIN	Bright	TIAIN
Cutting diameter tolerance class (TDC)	DC e8	DC e8	DC e8	DC e8	DC k10	DC k10	DC k12	DC k12	DC k12	DC h10	DC h10	DC h10	DC h10
Direction													
Basic standard group (BSG)	DIN 327D	DIN 844K	DIN 327D	DIN 844K	DIN 844K	DIN 844L	DIN 844K	DIN 844K	DIN 844L	DORMER	DORMER	DORMER	DORMER
Product Family Code	C110	C123	C306	C305	C247	C273	C407	C400	C403	S902	S922	S903	S933
	1.00 - 40.00	1/16 - 30.00	3.00 - 30.00	2.00 - 32.00	2.00 - 50.00	2.00 - 40.00	6.00 - 20.00	6.00 - 20.00	10.00 - 50.00	2.00 - 20.00	2.00 - 20.00	2.00 - 20.00	2.00 - 20.00
	216	218	220	221	223	225	227	228	229	230	231	232	233
P	P1	■	■	■	■	■	■	■	■	■	■	■	■
	P2	■	■	■	■	■	■	■	■	■	■	■	■
	P3	■	■	■	■	■	■	■	■	■	■	■	■
	P4	■	■	■	■	■	■	■	■	■	■	■	■
M	M1	■	■	■	■	■	■	■	■	■	■	■	■
	M2	■	■	■	■	■	■	■	■	■	■	■	■
	M3	■	■	■	■	■	■	■	■	■	■	■	■
	M4	■	■	■	■	■	■	■	■	■	■	■	■
K	K1	■	■	■	■	■	■	■	■	■	■	■	■
	K2	■	■	■	■	■	■	■	■	■	■	■	■
	K3	■	■	■	■	■	■	■	■	■	■	■	■
	K4	■	■	■	■	■	■	■	■	■	■	■	■
	K5	■	■	■	■	■	■	■	■	■	■	■	■
N	N1	■	■	■	■	■	■	■	■	■	■	■	■
	N2	■	■	■	■	■	■	■	■	■	■	■	■
	N3	■	■	■	■	■	■	■	■	■	■	■	■
	N4	■	■	■	■	■	■	■	■	■	■	■	■
	N5	■	■	■	■	■	■	■	■	■	■	■	■
S	S1	■	■	■	■	■	■	■	■	■	■	■	■
	S2	■	■	■	■	■	■	■	■	■	■	■	■
	S3	■	■	■	■	■	■	■	■	■	■	■	■
	S4	■	■	■	■	■	■	■	■	■	■	■	■
H	H1	■	■	■	■	■	■	■	■	■	■	■	■
	H2	■	■	■	■	■	■	■	■	■	■	■	■
	H3	■	■	■	■	■	■	■	■	■	■	■	■
	H4	■	■	■	■	■	■	■	■	■	■	■	■

■ Primary use ■ Possible use

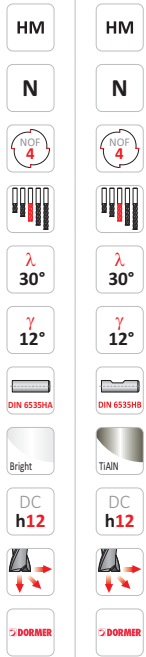

S904	S944	S991																	
------	------	------	--	--	--	--	--	--	--	--	--	--	--	--	--	--	--	--	--

2.00 - 20.00	2.00 - 20.00	Set																	
--------------	--------------	-----	--	--	--	--	--	--	--	--	--	--	--	--	--	--	--	--	--

📖 234	📖 235	📖 236																	
-------	-------	-------	--	--	--	--	--	--	--	--	--	--	--	--	--	--	--	--	--

P1	■	■																	
P2	■	■																	
P3	■	■																	
P4	☑	■																	
M1																			
M2																			
M3																			
M4																			
K1	☑	■																	
K2	■	■																	
K3	■	■																	
K4	☑	■																	
K5	■	■																	
N1	☑	☑																	
N2	☑	■																	
N3	■	■																	
N4	☑	☑																	
N5																			
S1	☑	☑																	
S2	☑	☑																	
S3	☑	☑																	
S4	☑	☑																	
H1																			
H2																			
H3																			
H4																			

C110



2-Flute HSS-E-PM Slot End Mill, Bright Finish

Extra short cut length, 2-flute design provides high rigidity. Suitable for milling shallow slots and ramping. The accurate diameter means the tools are designed for milling standard keyway slots to a P9 tolerance. Versatile and can be used in mild steels, non-ferrous materials and medium strength titanium alloys.

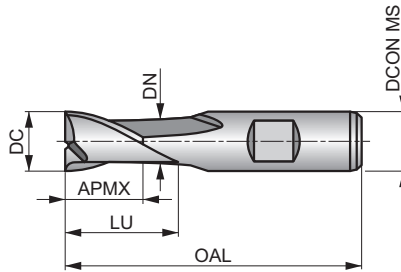

HSS-E PM	N	NOF 2
	λ 30°	γ 12°
	Bright	DC e8
	DIN 327D	



Workpiece material group suitability, starting values for cutting speed (m/min) and Alpha Code. Tables with feed per tooth and correction factors can be found starting from page 240.

P1.1 ■ 53 E	P1.2 ■ 59 E	P1.3 ■ 61 E	P2.1 ■ 45 E	P2.2 ■ 40 E	P3.1 ■ 37 E	P3.2 ■ 30 D	P4.1 ■ 22 D	M1.1 ■ 41 E	M1.2 ■ 35 E	M2.1 ■ 37 E	M2.2 ■ 30 D	K1.1 ■ 35 E	K1.2 ■ 26 E
K1.3 ■ 19 E	K2.1 ■ 62 E	K2.2 ■ 50 E	K2.3 ■ 40 D	K3.1 ■ 54 E	K3.2 ■ 42 E	K3.3 ■ 34 D	K4.1 ■ 50 D	K4.2 ■ 38 D	K4.3 ■ 28 D	K4.4 ■ 24 C	K4.5 ■ 20 C	K5.1 ■ 57 D	K5.2 ■ 43 D
K5.3 ■ 33 D	N1.1 ■ 95 G	N1.2 ■ 71 F	N1.3 ■ 48 F	N2.1 ■ 48 E	N2.2 ■ 43 E	N2.3 ■ 31 E	N3.1 ■ 50 E	N3.2 ■ 29 E	N3.3 ■ 15 E	N4.1 ■ 50 E	S1.1 ■ 35 D	S1.2 ■ 25 D	S2.1 ■ 20 C
S3.1 ■ 15 C	S4.1 ■ 12 C												

DCON MS tolerance h6.

Product	DC (inch)	DC (mm)	DCON MS (mm)	APMX (mm)	OAL (mm)	NOF	LU (mm)	DN (mm)
C1101.0	–	1.00	6.00	2.50	47.0	2	–	–
C1101.5	–	1.50	6.00	3.00	47.0	2	–	–
C1101/16	1/16	1.59	6.00	3.00	47.0	2	–	–
C1101.8	–	1.80	6.00	4.00	48.0	2	–	–
C1102.0	–	2.00	6.00	4.00	48.0	2	–	–
C1103/32	3/32	2.38	6.00	5.00	49.0	2	–	–
C1102.5	–	2.50	6.00	5.00	49.0	2	–	–
C1102.8	–	2.80	6.00	5.00	49.0	2	–	–
C1103.0	–	3.00	6.00	5.00	49.0	2	–	–
C1101/8	1/8	3.18	6.00	6.00	50.0	2	–	–
C1103.5	–	3.50	6.00	6.00	50.0	2	–	–
C1103.8	–	3.80	6.00	7.00	51.0	2	–	–
C1104.0	–	4.00	6.00	7.00	51.0	2	–	–
C1104.5	–	4.50	6.00	7.00	51.0	2	–	–
C1103/16	3/16	4.76	6.00	8.00	52.0	2	–	–
C1104.8 ²⁾	–	4.80	6.00	8.00	52.0	2	–	–
C1105.0	–	5.00	6.00	8.00	52.0	2	–	–
C1105.5	–	5.50	6.00	8.00	52.0	2	–	–
C1105.75 ²⁾	–	5.75	6.00	8.00	52.0	2	–	–
C1106.0	–	6.00	6.00	8.00	52.0	2	–	–
C1101/4	1/4	6.35	10.00	10.00	60.0	2	–	–
C1106.5	–	6.50	10.00	10.00	60.0	2	–	–
C1107.0	–	7.00	10.00	10.00	60.0	2	–	–
C1107.5	–	7.50	10.00	10.00	60.0	2	–	–
C1107.75 ²⁾	–	7.75	10.00	11.00	61.0	2	–	–



Product	DC	DC	DCON MS	APMX	OAL	NOF	LU	DN
	(inch)	(mm)	(mm)	(mm)	(mm)		(mm)	(mm)
C1105/16	5/16	7.94	10.00	11.00	61.0	2	–	–
C1108.0	–	8.00	10.00	11.00	61.0	2	–	–
C1108.5	–	8.50	10.00	11.00	61.0	2	–	–
C1109.0	–	9.00	10.00	11.00	61.0	2	–	–
C1109.5	–	9.50	10.00	11.00	61.0	2	–	–
C1103/8	3/8	9.52	10.00	13.00	63.0	2	22.50	9.50
C11010.0	–	10.00	10.00	13.00	63.0	2	22.50	9.50
C11013/32	13/32	10.32	12.00	13.00	70.0	2	–	–
C11010.5	–	10.50	12.00	13.00	70.0	2	–	–
C11011.0	–	11.00	12.00	13.00	70.0	2	–	–
C1107/16	7/16	11.11	12.00	13.00	70.0	2	–	–
C11011.5	–	11.50	12.00	13.00	70.0	2	–	–
C11012.0	–	12.00	12.00	16.00	73.0	2	27.50	11.50
C11012.5	–	12.50	12.00	16.00	73.0	2	27.50	11.50
C1101/2	1/2	12.70	12.00	16.00	73.0	2	27.50	11.50
C11013.0	–	13.00	12.00	16.00	73.0	2	27.50	11.50
C11017/32	17/32	13.49	12.00	16.00	73.0	2	27.50	11.50
C11014.0	–	14.00	12.00	16.00	73.0	2	27.50	11.50
C1109/16	9/16	14.29	12.00	16.00	73.0	2	27.50	11.50
C11015.0	–	15.00	12.00	16.00	73.0	2	27.50	11.50
C1105/8	5/8	15.88	16.00	19.00	79.0	2	30.50	15.50
C11016.0	–	16.00	16.00	19.00	79.0	2	30.50	15.50
C11017.0	–	17.00	16.00	19.00	79.0	2	30.50	15.50
C11011/16	11/16	17.46	16.00	19.00	79.0	2	30.50	15.50
C11018.0	–	18.00	16.00	19.00	79.0	2	30.50	15.50
C11019.0	–	19.00	16.00	19.00	79.0	2	30.50	15.50
C1103/4	3/4	19.05	20.00	22.00	88.0	2	37.50	18.50
C11020.0	–	20.00	20.00	22.00	88.0	2	37.50	19.50
C11022.0	–	22.00	20.00	22.00	88.0	2	37.50	19.50
C1107/8	7/8	22.22	20.00	22.00	88.0	2	37.50	19.50
C11024.0	–	24.00	25.00	26.00	102.0	2	45.50	23.50
C11025.0	–	25.00	25.00	26.00	102.0	2	45.50	24.50
C1101	1"	25.40	25.00	26.00	102.0	2	45.50	24.50
C11026.0	–	26.00	25.00	26.00	102.0	2	45.50	24.50
C11028.0	–	28.00	25.00	26.00	102.0	2	45.50	24.50
C11030.0	–	30.00	25.00	26.00	102.0	2	45.50	24.50
C11032.0	–	32.00	32.00	32.00	112.0	2	51.50	31.50
C11035.0 ¹⁾	–	35.00	32.00	32.00	112.0	2	51.50	31.50
C11036.0 ¹⁾	–	36.00	32.00	32.00	112.0	2	51.50	31.50
C11040.0 ¹⁾	–	40.00	40.00	38.00	130.0	2	59.50	39.00

¹⁾ DC tolerance h10; available in HSS-E only.

²⁾ DC tolerance h10; slot not in P9 tolerance.

C123



2-Flute HSS-E-PM Slot End Mill, Bright Finish

Short cut length, 2-flute design provides high rigidity. Suitable for milling shallow slots and ramping. The accurate diameter means the tools are designed for milling standard keyway slots to a P9 tolerance. Versatile and can be used in mild steels, non-ferrous materials and medium strength titanium alloys.

HSS-E PM	N	NOF 2
	λ 30°	γ 12°
	Bright	DC e8
	DIN 844K	

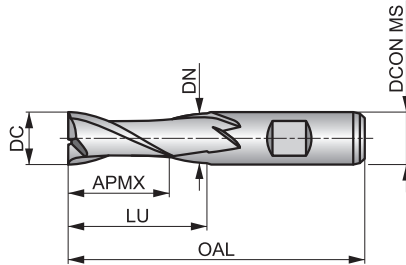

Workpiece material group suitability, starting values for cutting speed (m/min) and Alpha Code. Tables with feed per tooth and correction factors can be found starting from page 240.

P1.1 ■ 53 D	P1.2 ■ 59 D	P1.3 ■ 61 D	P2.1 ■ 45 D	P2.2 ■ 40 D	P3.1 ■ 37 D	P3.2 ■ 30 C	P4.1 ■ 22 C	M1.1 ■ 34 D	M1.2 ■ 29 D	M2.1 ■ 31 D	M2.2 ■ 25 C	K1.1 ■ 30 D	K1.2 ■ 22 D
K1.3 ■ 17 D	K2.1 ■ 55 D	K2.2 ■ 45 D	K2.3 ■ 36 C	K3.1 ■ 49 D	K3.2 ■ 37 D	K3.3 ■ 30 B	K4.1 ■ 45 C	K4.2 ■ 34 C	K4.3 ■ 25 C	K4.4 ■ 22 B	K4.5 ■ 18 B	K5.1 ■ 51 C	K5.2 ■ 39 C
K5.3 ■ 30 C	N1.1 ■ 95 F	N1.2 ■ 71 E	N1.3 ■ 48 E	N2.1 ■ 48 D	N2.2 ■ 43 D	N2.3 ■ 31 D	N3.1 ■ 50 D	N3.2 ■ 29 D	N3.3 ■ 15 D	N4.1 ■ 50 D	S1.1 ■ 30 C	S1.2 ■ 25 C	S2.1 ■ 20 B
S3.1 ■ 15 B	S4.1 ■ 12 B												

DCON MS tolerance h6.

Product	DC (inch)	DC (mm)	DCON MS (mm)	APMX (mm)	OAL (mm)	NOF	LU (mm)	DN (mm)
C1231/16 ¹⁾	1/16	1.59	6.00	7.00	51.0	2	–	–
C1232.0	–	2.00	6.00	7.00	51.0	2	–	–
C1232.5	–	2.50	6.00	8.00	52.0	2	–	–
C1233.0	–	3.00	6.00	8.00	52.0	2	–	–
C1231/8 ¹⁾	1/8	3.18	6.00	10.00	54.0	2	–	–
C1233.5	–	3.50	6.00	10.00	54.0	2	–	–
C1235/32 ¹⁾	5/32	3.97	6.00	11.00	55.0	2	–	–
C1234.0	–	4.00	6.00	11.00	55.0	2	–	–
C1234.5	–	4.50	6.00	11.00	55.0	2	–	–
C1233/16 ¹⁾	3/16	4.76	6.00	13.00	57.0	2	–	–
C1235.0	–	5.00	6.00	13.00	57.0	2	–	–
C1235.5	–	5.50	6.00	13.00	57.0	2	–	–
C1236.0	–	6.00	6.00	13.00	57.0	2	–	–
C1231/4 ¹⁾	1/4	6.35	10.00	16.00	66.0	2	–	–
C1236.5	–	6.50	10.00	16.00	66.0	2	–	–
C1237.0	–	7.00	10.00	16.00	66.0	2	–	–
C1237.5	–	7.50	10.00	16.00	66.0	2	–	–
C1235/16 ¹⁾	5/16	7.94	10.00	19.00	69.0	2	–	–
C1238.0	–	8.00	10.00	19.00	69.0	2	–	–
C1238.5	–	8.50	10.00	19.00	69.0	2	–	–
C1239.0	–	9.00	10.00	19.00	69.0	2	–	–
C1239.5	–	9.50	10.00	19.00	69.0	2	–	–
C1233/8 ¹⁾	3/8	9.52	10.00	22.00	72.0	2	31.50	9.50
C12310.0	–	10.00	10.00	22.00	72.0	2	31.50	9.50
C12311.0	–	11.00	12.00	22.00	79.0	2	–	–



Product	DC	DC	DCON MS	APMX	OAL	NOF	LU	DN
	(inch)	(mm)	(mm)	(mm)	(mm)		(mm)	(mm)
C12312.0	–	12.00	12.00	26.00	83.0	2	37.50	11.50
C1231/2¹⁾	1/2	12.70	12.00	26.00	83.0	2	37.50	11.50
C12313.0	–	13.00	12.00	26.00	83.0	2	37.50	11.50
C12314.0	–	14.00	12.00	26.00	83.0	2	37.50	11.50
C12315.0	–	15.00	12.00	26.00	83.0	2	37.50	11.50
C12316.0	–	16.00	16.00	32.00	92.0	2	43.50	15.50
C12318.0	–	18.00	16.00	32.00	92.0	2	43.50	15.50
C12320.0	–	20.00	20.00	38.00	104.0	2	53.50	19.50
C12322.0	–	22.00	20.00	38.00	104.0	2	53.50	19.50
C12325.0	–	25.00	25.00	45.00	121.0	2	64.50	24.50
C12330.0	–	30.00	25.00	45.00	121.0	2	64.50	24.50

¹⁾ DC tolerance -0.0005 inches/-0.0013 inches.

C306



3-Flute HSS-E-PM Slot End Mill, Bright Finish

Extra short cut length, 3-flute design provides high rigidity and is suitable for milling shallow slots and ramping. The accurate diameter means the tools are designed for milling standard keyway slots to a P9 tolerance. Versatile and can be used in mild steels and non-ferrous materials.

HSS-E PM	N	NOF 3
	λ 30°	γ 12°
	Bright	DC e8
	DIN 327D	

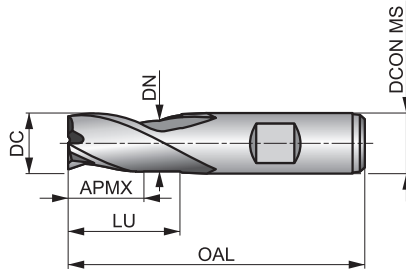

Workpiece material group suitability, starting values for cutting speed (m/min) and Alpha Code. Tables with feed per tooth and correction factors can be found starting from page 240.

P1.1 ■ 54 E	P1.2 ■ 61 E	P1.3 ■ 63 E	P2.1 ■ 47 E	P2.2 ■ 41 E	P3.1 ■ 38 E	P3.2 ■ 31 D	P4.1 ■ 23 D	M1.1 ■ 36 E	M1.2 ■ 30 E	M2.1 ■ 32 E	M2.2 ■ 26 D	K1.1 ■ 32 E	K1.2 ■ 24 E
K1.3 ■ 18 E	K2.1 ■ 59 E	K2.2 ■ 48 E	K2.3 ■ 38 D	K3.1 ■ 52 E	K3.2 ■ 40 E	K3.3 ■ 32 D	K4.1 ■ 48 D	K4.2 ■ 37 D	K4.3 ■ 27 D	K4.4 ■ 23 C	K4.5 ■ 19 C	K5.1 ■ 55 D	K5.2 ■ 41 D
K5.3 ■ 32 D	N1.3 ■ 50 F	N2.1 ■ 50 E	N2.2 ■ 45 E	N2.3 ■ 32 E	N3.1 ■ 52 E	N3.2 ■ 30 E	N3.3 ■ 16 E	N4.1 ■ 52 E	S1.1 ■ 33 D	S1.2 ■ 26 D	S2.1 ■ 20 C	S3.1 ■ 15 C	S4.1 ■ 12 C

DCON MS tolerance h6.

Product	DC (mm)	DCON MS (mm)	APMX (mm)	OAL (mm)	NOF	LU (mm)	DN (mm)
C3063.0	3.00	6.00	5.00	49.0	3	–	–
C3064.0	4.00	6.00	7.00	51.0	3	–	–
C3065.0	5.00	6.00	8.00	52.0	3	–	–
C3066.0	6.00	6.00	8.00	52.0	3	–	–
C3067.0	7.00	10.00	10.00	60.0	3	–	–
C3068.0	8.00	10.00	11.00	61.0	3	–	–
C3069.0	9.00	10.00	11.00	61.0	3	–	–
C3069.5	9.50	10.00	11.00	61.0	3	–	–
C30610.0	10.00	10.00	13.00	63.0	3	22.50	9.50
C30611.0	11.00	12.00	13.00	70.0	3	–	–
C30612.0	12.00	12.00	16.00	73.0	3	27.50	11.50
C30614.0	14.00	12.00	16.00	73.0	3	27.50	11.50
C30615.0	15.00	12.00	16.00	73.0	3	27.50	11.50
C30616.0	16.00	16.00	19.00	79.0	3	30.50	15.50
C30618.0	18.00	16.00	19.00	79.0	3	30.50	15.50
C30620.0	20.00	20.00	22.00	88.0	3	37.50	19.50
C30622.0	22.00	20.00	22.00	88.0	3	37.50	19.50
C30625.0	25.00	25.00	26.00	102.0	3	45.50	24.50
C30630.0	30.00	25.00	26.00	102.0	3	45.50	24.50

C305



3-Flute HSS-E-PM Slot End Mill, Bright Finish

Short cut length, 3-flute design provides high rigidity for milling slots whilst the accurate diameter means that standard keyway slots to P9 tolerance can be milled. Suitable also for ramping and profile milling in mild steels, non-ferrous materials and medium strength high temperature alloys.

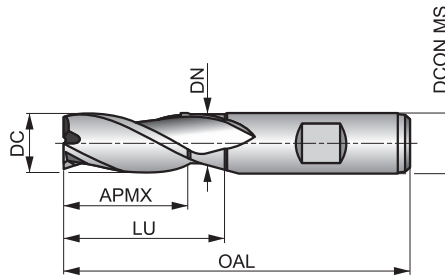

HSS-E PM	N	NOF 3
	λ 30°	γ 12°
DIN 1835B	Bright	DC e8
	DIN 844K	



Workpiece material group suitability, starting values for cutting speed (m/min) and Alpha Code. Tables with feed per tooth and correction factors can be found starting from page 240.

P1.1 ■ 52 D	P1.2 ■ 58 D	P1.3 ■ 60 D	P2.1 ■ 44 D	P2.2 ■ 39 D	P3.1 ■ 36 D	P3.2 ■ 29 C	P4.1 ■ 21 C	M1.1 ■ 36 D	M1.2 ■ 30 D	M2.1 ■ 32 D	M2.2 ■ 26 C	K1.1 ■ 30 D	K1.2 ■ 22 D
K1.3 ■ 17 D	K2.1 ■ 55 D	K2.2 ■ 45 D	K2.3 ■ 36 C	K3.1 ■ 49 D	K3.2 ■ 37 D	K3.3 ■ 30 B	K4.1 ■ 45 C	K4.2 ■ 34 C	K4.3 ■ 25 C	K4.4 ■ 22 B	K4.5 ■ 18 B	K5.1 ■ 51 C	K5.2 ■ 39 C
K5.3 ■ 30 C	N1.3 ■ 48 E	N2.1 ■ 48 D	N2.2 ■ 43 D	N2.3 ■ 31 D	N3.1 ■ 50 D	N3.2 ■ 29 D	N3.3 ■ 15 D	N4.1 ■ 50 D	S1.1 ■ 29 C	S1.2 ■ 24 C	S2.1 ■ 17 B	S3.1 ■ 13 B	S4.1 ■ 10 B

DCON MS tolerance h6.

Product	DC (mm)	DCON MS (mm)	APMX (mm)	OAL (mm)	NOF	LU (mm)	DN (mm)
C3052.0	2.00	6.00	7.00	51.0	3	–	–
C3052.5	2.50	6.00	8.00	52.0	3	–	–
C3053.0	3.00	6.00	8.00	52.0	3	–	–
C3053.5	3.50	6.00	10.00	54.0	3	–	–
C3054.0	4.00	6.00	11.00	55.0	3	–	–
C3054.5	4.50	6.00	11.00	55.0	3	–	–
C3055.0	5.00	6.00	13.00	57.0	3	–	–
C3055.5	5.50	6.00	13.00	57.0	3	–	–
C3056.0	6.00	6.00	13.00	57.0	3	–	–
C3056.5	6.50	10.00	16.00	66.0	3	–	–
C3057.0	7.00	10.00	16.00	66.0	3	–	–
C3057.5	7.50	10.00	16.00	66.0	3	–	–
C3058.0	8.00	10.00	19.00	69.0	3	–	–
C3058.5	8.50	10.00	19.00	69.0	3	–	–
C3059.0	9.00	10.00	19.00	69.0	3	–	–
C30510.0	10.00	10.00	22.00	72.0	3	31.50	9.50
C30511.0	11.00	12.00	22.00	79.0	3	–	–
C30512.0	12.00	12.00	26.00	83.0	3	37.50	11.50
C30513.0	13.00	12.00	26.00	83.0	3	37.50	11.50
C30514.0	14.00	12.00	26.00	83.0	3	37.50	11.50
C30515.0	15.00	12.00	26.00	83.0	3	37.50	11.50
C30516.0	16.00	16.00	32.00	92.0	3	43.50	15.50
C30517.0	17.00	16.00	32.00	92.0	3	43.50	15.50
C30518.0	18.00	16.00	32.00	92.0	3	43.50	15.50
C30519.0	19.00	16.00	32.00	92.0	3	43.50	15.50
C30520.0	20.00	20.00	38.00	104.0	3	53.50	19.50
C30522.0	22.00	20.00	38.00	104.0	3	53.50	19.50



Product	DC	DCON MS	APMX	OAL	NOF	LU	DN
	(mm)	(mm)	(mm)	(mm)		(mm)	(mm)
C30525.0	25.00	25.00	45.00	121.0	3	–	–
C30528.0	28.00	25.00	45.00	121.0	3	–	–
C30530.0	30.00	25.00	45.00	121.0	3	–	–
C30532.0	32.00	32.00	53.00	133.0	3	–	–

C247



Multi-Flute HSS-E-PM End Mill, Bright Finish

Short cut length, 4, 5, 6 or 8 flute design provides high rigidity for general profile and ramp milling applications in mild steels and non-ferrous materials.

HSS-E PM	N	NOF 4-8
	λ 30°	γ 12°
DIN 1835B	Bright	DC k10
	DIN 844K	

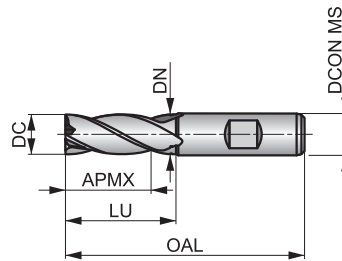

Workpiece material group suitability, starting values for cutting speed (m/min) and Alpha Code. Tables with feed per tooth and correction factors can be found starting from page 240.

P1.1 ■ 53 D	P1.2 ■ 59 D	P1.3 ■ 61 D	P2.1 ■ 45 D	P2.2 ■ 40 D	P3.1 ■ 36 D	P3.2 ■ 29 C	P4.1 ■ 22 C	M1.1 ■ 34 D	M1.2 ■ 29 D	M2.1 ■ 31 D	M2.2 ■ 25 C	K1.1 ■ 30 D	K1.2 ■ 22 D
K1.3 ■ 17 D	K2.1 ■ 55 D	K2.2 ■ 45 D	K2.3 ■ 36 C	K3.1 ■ 49 D	K3.2 ■ 37 D	K3.3 ■ 30 B	K4.1 ■ 45 C	K4.2 ■ 34 C	K4.3 ■ 25 C	K4.4 ■ 22 B	K4.5 ■ 18 B	K5.1 ■ 51 C	K5.2 ■ 39 C
K5.3 ■ 30 C	N1.1 ■ 95 F	N1.2 ■ 71 E	N1.3 ■ 48 E	N2.1 ■ 48 D	N2.2 ■ 43 D	N2.3 ■ 31 D	N3.1 ■ 50 D	N3.2 ■ 29 D	N3.3 ■ 15 D	N4.1 ■ 50 D	S1.1 ■ 30 C	S1.2 ■ 25 C	S2.1 ■ 20 B
S3.1 ■ 15 B	S4.1 ■ 12 B												

DCON MS tolerance h6.

Product	DC (inch)	DC (mm)	DCON MS (mm)	APMX (mm)	OAL (mm)	NOF	LU (mm)	DN (mm)
C2472.0	–	2.00	6.00	7.00	51.0	4	–	–
C2472.5	–	2.50	6.00	8.00	52.0	4	–	–
C2473.0	–	3.00	6.00	8.00	52.0	4	–	–
C2471/8 ²⁾	1/8	3.18	6.00	10.00	54.0	4	–	–
C2473.5	–	3.50	6.00	10.00	54.0	4	–	–
C2474.0	–	4.00	6.00	11.00	55.0	4	–	–
C2474.5	–	4.50	6.00	11.00	55.0	4	–	–
C2473/16 ²⁾	3/16	4.76	6.00	13.00	57.0	4	–	–
C2475.0	–	5.00	6.00	13.00	57.0	4	–	–
C2475.5	–	5.50	6.00	13.00	57.0	4	–	–
C2476.0	–	6.00	6.00	13.00	57.0	4	–	–
C2471/4 ²⁾	1/4	6.35	10.00	16.00	66.0	4	–	–
C2476.5	–	6.50	10.00	16.00	66.0	4	–	–
C2477.0	–	7.00	10.00	16.00	66.0	4	–	–
C2477.5	–	7.50	10.00	16.00	66.0	4	–	–
C2475/16 ²⁾	5/16	7.94	10.00	19.00	69.0	4	–	–
C2478.0	–	8.00	10.00	19.00	69.0	4	–	–
C2478.5	–	8.50	10.00	19.00	69.0	4	–	–
C2479.0	–	9.00	10.00	19.00	69.0	4	–	–
C2479.5	–	9.50	10.00	19.00	69.0	4	–	–
C2473/8 ²⁾	3/8	9.52	10.00	22.00	72.0	4	31.50	9.50
C24710.0	–	10.00	10.00	22.00	72.0	4	31.50	9.50
C24711.0	–	11.00	12.00	22.00	79.0	4	–	–
C24712.0	–	12.00	12.00	26.00	83.0	4	37.50	11.50
C2471/2 ²⁾	1/2	12.70	12.00	26.00	83.0	4	37.50	11.50



Product	DC	DC	D CON MS	APMX	OAL	NOF	LU	DN
	(inch)	(mm)	(mm)	(mm)	(mm)		(mm)	(mm)
C24713.0	–	13.00	12.00	26.00	83.0	4	37.50	11.50
C24714.0	–	14.00	12.00	26.00	83.0	4	37.50	11.50
C2479/16²⁾	9/16	14.29	12.00	26.00	83.0	4	37.50	11.50
C24715.0	–	15.00	12.00	26.00	83.0	4	37.50	11.50
C2475/8²⁾	5/8	15.88	16.00	32.00	92.0	4	43.50	15.50
C24716.0	–	16.00	16.00	32.00	92.0	4	43.50	15.50
C24717.0	–	17.00	16.00	32.00	92.0	4	43.50	15.50
C24718.0	–	18.00	16.00	32.00	92.0	4	43.50	15.50
C24719.0	–	19.00	16.00	32.00	92.0	4	43.50	15.50
C2473/4²⁾	3/4	19.05	20.00	38.00	104.0	4	53.50	18.50
C24720.0	–	20.00	20.00	38.00	104.0	4	53.50	19.50
C24721.0	–	21.00	20.00	38.00	104.0	4	53.50	19.50
C24722.0	–	22.00	20.00	38.00	104.0	5	53.50	19.50
C2477/8²⁾	7/8	22.22	20.00	38.00	104.0	5	53.50	19.50
C24723.0	–	23.00	20.00	38.00	104.0	5	53.50	19.50
C24724.0	–	24.00	25.00	45.00	121.0	5	64.50	23.50
C24725.0	–	25.00	25.00	45.00	121.0	5	64.50	24.50
C2471²⁾	1"	25.40	25.00	45.00	121.0	5	64.50	24.50
C24726.0	–	26.00	25.00	45.00	121.0	6	64.50	24.50
C24728.0	–	28.00	25.00	45.00	121.0	6	64.50	24.50
C24730.0	–	30.00	25.00	45.00	121.0	6	64.50	24.50
C24732.0	–	32.00	32.00	53.00	133.0	6	72.50	31.50
C24736.0¹⁾	–	36.00	32.00	53.00	133.0	6	72.50	31.50
C24740.0¹⁾	–	40.00	40.00	63.00	155.0	6	84.50	39.00
C24750.0¹⁾	–	50.00	50.00	75.00	177.0	8	96.50	48.00

¹⁾ Available in HSS-E only; no centre cutting.

²⁾ DC tolerance +0.0025 inches/-0.0005 inches.

C273

Multi-Flute HSS-E-PM Long Series End Mill, Bright Finish

Long cut length, 4, 5 or 6 flute design provides high rigidity for finishing deep profiles in mild steels and non-ferrous materials, such as aluminium and medium strength titanium alloys.

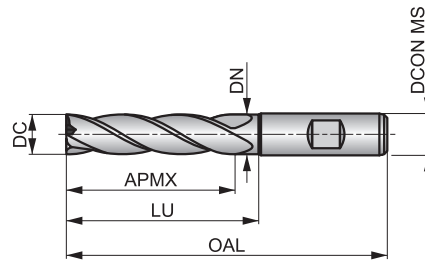

HSS-E PM	N	NOF 4-6
	λ 30°	γ 12°
DIN 1835B	Bright	DC k10
	DIN 844L	



Workpiece material group suitability, starting values for cutting speed (m/min) and Alpha Code. Tables with feed per tooth and correction factors can be found starting from page 240.

P1.1 ■ 46 C	P1.2 ■ 52 C	P1.3 ■ 54 C	P2.1 ■ 40 C	P2.2 ■ 35 C	P3.1 ■ 32 C	P3.2 ■ 26 B	P4.1 ■ 19 B	M1.1 ■ 14 C	M1.2 ■ 12 C	M2.1 ■ 12 C	M2.2 ■ 10 B	K1.1 ■ 25 C	K1.2 ■ 19 C
K1.3 ■ 14 C	K2.1 ■ 49 C	K2.2 ■ 40 C	K2.3 ■ 32 B	K3.1 ■ 44 C	K3.2 ■ 33 C	K3.3 ■ 27 A	K4.1 ■ 40 B	K4.2 ■ 30 B	K4.3 ■ 22 B	K4.4 ■ 19 A	K4.5 ■ 16 A	K5.1 ■ 46 B	K5.2 ■ 34 B
K5.3 ■ 27 B	N1.1 ■ 81 E	N1.2 ■ 60 D	N1.3 ■ 41 D	N2.1 ■ 41 C	N2.2 ■ 37 C	N2.3 ■ 26 C	N3.1 ■ 43 C	N3.2 ■ 25 C	N3.3 ■ 13 C	N4.1 ■ 43 C	S1.1 ■ 25 B	S1.2 ■ 20 B	S2.1 ■ 13 A
S3.1 ■ 10 A	S4.1 ■ 8 A												

DCON MS tolerance h6.

Product	DC (inch)	DC (mm)	DCON MS (mm)	APMX (mm)	OAL (mm)	NOF	LU (mm)	DN (mm)
C2732.0	–	2.00	6.00	10.00	54.0	4	–	–
C2732.5	–	2.50	6.00	12.00	56.0	4	–	–
C2733.0	–	3.00	6.00	12.00	56.0	4	–	–
C2731/8 ²⁾	1/8	3.18	6.00	15.00	59.0	4	–	–
C2733.5	–	3.50	6.00	15.00	59.0	4	–	–
C2734.0	–	4.00	6.00	19.00	63.0	4	–	–
C2734.5	–	4.50	6.00	19.00	63.0	4	–	–
C2733/16 ²⁾	3/16	4.76	6.00	24.00	68.0	4	–	–
C2735.0	–	5.00	6.00	24.00	68.0	4	–	–
C2735.5	–	5.50	6.00	24.00	68.0	4	–	–
C2736.0	–	6.00	6.00	24.00	68.0	4	–	–
C2731/4 ²⁾	1/4	6.35	10.00	30.00	80.0	4	–	–
C2737.0	–	7.00	10.00	30.00	80.0	4	–	–
C2738.0	–	8.00	10.00	38.00	88.0	4	–	–
C2739.0	–	9.00	10.00	38.00	88.0	4	–	–
C2733/8 ²⁾	3/8	9.52	10.00	45.00	95.0	4	54.50	9.50
C27310.0	–	10.00	10.00	45.00	95.0	4	54.50	9.50
C27311.0	–	11.00	12.00	45.00	102.0	4	–	–
C27312.0	–	12.00	12.00	53.00	110.0	4	64.50	11.50
C2731/2 ²⁾	1/2	12.70	12.00	53.00	110.0	4	64.50	11.50
C27313.0	–	13.00	12.00	53.00	110.0	4	64.50	11.50
C27314.0	–	14.00	12.00	53.00	110.0	4	64.50	11.50
C27315.0	–	15.00	12.00	53.00	110.0	4	64.50	11.50
C2735/8 ²⁾	5/8	15.88	16.00	63.00	123.0	4	74.50	15.50
C27316.0	–	16.00	16.00	63.00	123.0	4	74.50	15.50



Product	DC	DC	DCON MS	APMX	OAL	NOF	LU	DN
	(inch)	(mm)	(mm)	(mm)	(mm)		(mm)	(mm)
C27318.0	–	18.00	16.00	63.00	123.0	4	74.50	15.50
C2733/4 ²⁾	3/4	19.05	20.00	75.00	141.0	4	90.50	18.50
C27320.0	–	20.00	20.00	75.00	141.0	4	90.50	19.50
C27322.0	–	22.00	20.00	75.00	141.0	5	90.50	19.50
C27325.0	–	25.00	25.00	90.00	166.0	5	109.50	24.50
C2731 ²⁾	1"	25.40	25.00	90.00	166.0	5	109.50	24.50
C27328.0	–	28.00	25.00	90.00	166.0	6	109.50	24.50
C27330.0	–	30.00	25.00	90.00	166.0	6	109.50	24.50
C27332.0	–	32.00	32.00	106.00	186.0	6	125.50	31.50
C27340.0 ¹⁾	–	40.00	40.00	125.00	217.0	6	146.50	39.00

¹⁾ Available in HSS-E only; no centre cutting.

²⁾ DC tolerance +0.0025 inches/-0.0005 inches.

C407

4-Flute HSS-E-PM Roughing End Mill, Bright Finish

Short cut length, 4-flute design with neck recess on big cutting diameter sizes and an NRA profile to break chips for efficient roughing applications. A 35° helix reduces vibration and improves performance in roughing operations.

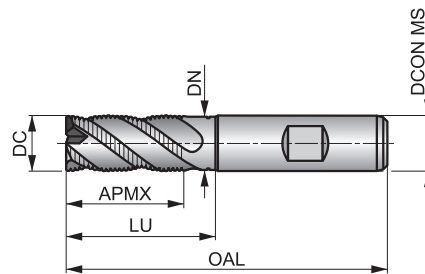

HSS-E PM	NRA	NOF 4
	λ 35°	γ 12°
	Bright	DC k12
	DIN 844K	



Workpiece material group suitability, starting values for cutting speed (m/min) and Alpha Code. Tables with feed per tooth and correction factors can be found starting from page 240.

P1.1 ■ 50 G	P1.2 ■ 56 G	P1.3 ■ 58 G	P2.1 ■ 43 G	P2.2 ■ 38 G	P2.3 ■ 34 F	P3.1 ■ 32 G	P3.2 ■ 26 F	P3.3 ■ 22 F	P4.1 ■ 19 F	P4.2 ■ 16 F	P4.3 ▣ 13 F	M1.1 ■ 34 G	M1.2 ■ 29 G
M2.1 ■ 31 G	M2.2 ■ 25 F	M3.1 ▣ 24 F	M3.2 ▣ 21 F	M3.3 ■ 19 E	M4.1 ■ 13 E	K1.1 ■ 30 G	K1.2 ■ 22 G	K1.3 ■ 17 G	K2.1 ■ 54 G	K2.2 ■ 44 G	K2.3 ■ 35 F	K3.1 ■ 48 G	K3.2 ■ 37 G
K3.3 ■ 30 F	K4.1 ■ 44 F	K4.2 ■ 33 F	K4.3 ■ 25 F	K4.4 ■ 21 E	K4.5 ■ 18 E	K5.1 ■ 50 F	K5.2 ■ 38 F	K5.3 ■ 29 F	N3.1 ■ 43 G	N3.2 ■ 25 G	S1.1 ▣ 30 F	S1.2 ■ 25 F	S1.3 ■ 11 E
S2.1 ■ 19 E	S2.2 ■ 8 E	S3.1 ■ 14 E	S3.2 ■ 6 E	S4.1 ■ 11 E	S4.2 ■ 5 E								

DCON MS tolerance h6.

Product	DC (mm)	DCON MS (mm)	APMX (mm)	OAL (mm)	NOF	LU (mm)	DN (mm)
C4076.0	6.00	6.00	13.00	57.0	4	–	–
C4077.0	7.00	10.00	16.00	66.0	4	–	–
C4078.0	8.00	10.00	19.00	69.0	4	–	–
C4079.0	9.00	10.00	19.00	69.0	4	–	–
C40710.0	10.00	10.00	22.00	72.0	4	31.50	9.50
C40711.0	11.00	12.00	22.00	79.0	4	–	–
C40712.0	12.00	12.00	26.00	83.0	4	37.50	11.50
C40713.0	13.00	12.00	26.00	83.0	4	37.50	11.50
C40714.0	14.00	12.00	26.00	83.0	4	37.50	11.50
C40715.0	15.00	12.00	26.00	83.0	4	37.50	11.50
C40716.0	16.00	16.00	32.00	92.0	4	43.50	15.50
C40718.0	18.00	16.00	32.00	92.0	4	43.50	15.50
C40720.0	20.00	20.00	38.00	104.0	4	53.50	19.50

C400



4-Flute HSS-E Roughing End Mill, Bright Finish

Short cut length, 4-flute design without center cut, for peripheral roughing operations only. The NF profile breaks chips for an efficient roughing operation. A 30° helix reduces vibrations and improves performance when roughing mild materials.

HSS-E	NF	NOF 4
	λ 30°	γ 12°
DIN 1835B	Bright	DC k12
	DIN 844K	

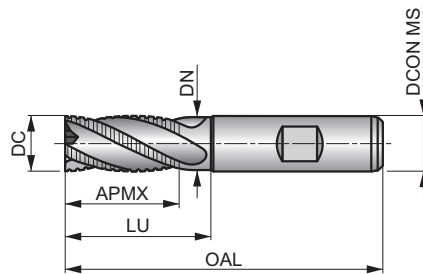

Workpiece material group suitability, starting values for cutting speed (m/min) and Alpha Code. Tables with feed per tooth and correction factors can be found starting from page 240.

P1.1 ■ 46 E	P1.2 ■ 52 E	P1.3 ■ 54 E	P2.1 ■ 40 E	P2.2 ■ 35 E	P3.1 ■ 32 E	P3.2 ■ 26 D	P4.1 ■ 19 D	M1.1 ■ 34 E	M1.2 ■ 29 E	M2.1 ■ 31 E	M2.2 ■ 25 D	K1.1 ■ 30 E	K1.2 ■ 22 E
K1.3 ■ 17 E	K2.1 ■ 49 E	K2.2 ■ 40 E	K2.3 ■ 32 D	K3.1 ■ 44 E	K3.2 ■ 33 E	K3.3 ■ 27 D	K4.1 ■ 40 D	K4.2 ■ 30 D	K4.3 ■ 22 D	K4.4 ■ 19 C	K4.5 ■ 16 C	K5.1 ■ 46 D	K5.2 ■ 34 D
K5.3 ■ 27 D	N1.3 ■ 41 F	N2.1 ■ 41 E	N2.2 ■ 37 E	N2.3 ■ 26 E	N3.1 ■ 43 E	N3.2 ■ 25 E	N3.3 ■ 13 E	N4.1 ■ 43 E	S1.1 ■ 30 D	S1.2 ■ 25 D	S2.1 ■ 20 C	S3.1 ■ 15 C	S4.1 ■ 12 C

DCON MS tolerance h6.

Product	DC (mm)	DCON MS (mm)	APMX (mm)	OAL (mm)	NOF	LU (mm)	DN (mm)
C4006.0	6.00	6.00	13.00	57.0	4	–	–
C4008.0	8.00	10.00	19.00	69.0	4	–	–
C40010.0	10.00	10.00	22.00	72.0	4	–	–
C40012.0	12.00	12.00	26.00	83.0	4	–	–
C40014.0	14.00	12.00	26.00	83.0	4	37.50	11.50
C40016.0	16.00	16.00	32.00	92.0	4	43.50	15.50
C40018.0	18.00	16.00	32.00	92.0	4	43.50	15.50
C40020.0	20.00	20.00	38.00	104.0	4	53.50	19.50

C403



Multi-Flute HSS-E Long Series Roughing End Mill, Bright Finish

Long cut length, 4, 5 or 6 flute design with no center cut for peripheral roughing operations only. The NF profile breaks chips for an efficient roughing operation. A 30° helix reduces vibrations and improves performance when roughing mild materials. Neck recess on cutting diameter equal to 14 mm and above.

HSS-E	NF	NOF 4-6
	λ 30°	γ 12°
DIN 1835B	Bright	DC k12
	DIN 844L	

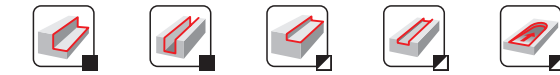
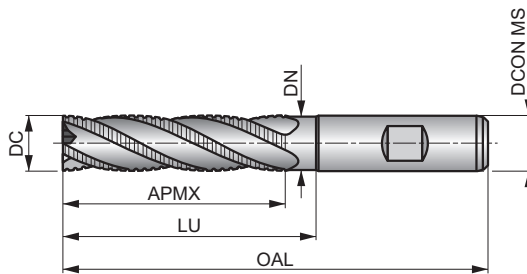

Workpiece material group suitability, starting values for cutting speed (m/min) and Alpha Code. Tables with feed per tooth and correction factors can be found starting from page 240.

P1.1 ■ 40 D	P1.2 ■ 45 D	P1.3 ■ 46 D	P2.1 ■ 34 D	P2.2 ■ 30 D	P3.1 ■ 28 D	P3.2 ■ 22 C	P4.1 ■ 16 C	M1.1 ■ 27 D	M1.2 ■ 23 D	M2.1 ■ 24 D	M2.2 ■ 20 C	K1.1 ■ 25 D	K1.2 ■ 19 D
K1.3 ■ 14 D	K2.1 ■ 43 D	K2.2 ■ 35 D	K2.3 ■ 28 C	K3.1 ■ 38 D	K3.2 ■ 29 D	K3.3 ■ 24 B	K4.1 ■ 35 C	K4.2 ■ 27 C	K4.3 ■ 20 C	K4.4 ■ 17 B	K4.5 ■ 14 B	K5.1 ■ 40 C	K5.2 ■ 30 C
K5.3 ■ 23 C	N1.3 ■ 38 E	N2.1 ■ 38 D	N2.2 ■ 34 D	N2.3 ■ 25 D	N3.1 ■ 40 D	N3.2 ■ 23 D	N3.3 ■ 12 D	N4.1 ■ 40 D	S1.1 ■ 25 C	S1.2 ■ 20 C	S2.1 ■ 13 B	S3.1 ■ 10 B	S4.1 ■ 8 B

DCON MS tolerance h6.

Product	DC (mm)	DCON MS (mm)	APMX (mm)	OAL (mm)	NOF	LU (mm)	DN (mm)
C40310.0	10.00	10.00	45.00	95.0	4	–	–
C40312.0	12.00	12.00	53.00	110.0	4	–	–
C40314.0	14.00	12.00	53.00	110.0	4	64.50	11.50
C40316.0	16.00	16.00	63.00	123.0	4	74.50	15.50
C40318.0	18.00	16.00	63.00	123.0	4	74.50	15.50
C40320.0	20.00	20.00	75.00	141.0	4	90.50	19.50
C40330.0	30.00	25.00	90.00	166.0	5	109.50	24.50
C40332.0	32.00	32.00	106.00	186.0	6	125.50	31.00
C40336.0	36.00	32.00	106.00	186.0	6	125.50	31.50
C40340.0	40.00	40.00	125.00	217.0	6	146.50	39.00
C40345.0	45.00	40.00	125.00	217.0	6	146.50	39.50
C40350.0	50.00	50.00	150.00	252.0	6	171.50	48.00

S902



2-Flute Solid Carbide End Mill

Medium cut length, 2-flute design with 30° helix provides high rigidity for milling standard slots.

HM	N	NOF 2
	λ 30°	γ 12°
DIN 6535HA	Bright	DC h10
	DORMER	

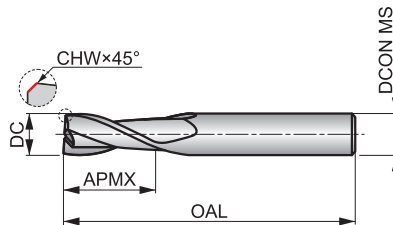

Workpiece material group suitability, starting values for cutting speed (m/min) and Alpha Code. Tables with feed per tooth and correction factors can be found starting from page 237.

P1.1 ■ 106 K	P1.2 ■ 119 K	P1.3 ■ 123 K	P2.1 ■ 91 K	P2.2 ■ 80 K	P2.3 ▣ 71 J	P3.1 ■ 66 K	P3.2 ■ 53 J	P3.3 ▣ 45 J	P4.1 ■ 40 J	P4.2 ▣ 34 J	K1.1 ■ 80 K	K1.2 ▣ 59 K	K1.3 ▣ 44 K
K2.1 ■ 98 K	K2.2 ■ 80 K	K2.3 ▣ 64 J	K3.1 ■ 87 K	K3.2 ■ 67 K	K3.3 ▣ 54 J	K4.1 ■ 81 J	K4.2 ■ 61 J	K4.3 ▣ 45 J	K4.4 ▣ 38 J	K4.5 ▣ 32 J	K5.1 ■ 91 J	K5.2 ■ 69 J	K5.3 ▣ 53 J
N1.1 ▣ 355 K	N1.2 ■ 267 K	N1.3 ■ 179 K	N2.1 ■ 179 K	N2.2 ▣ 160 K	N2.3 ▣ 115 K	N3.1 ■ 187 K	N3.2 ■ 109 K	N3.3 ■ 56 K	N4.1 ▣ 187 K	N4.2 ▣ 72 K	S1.1 ■ 38 J	S1.2 ▣ 36 J	S1.3 ▣ 15 J

DCON MS tolerance h6; DC≤10.00 mm: CHW ± 0.03x45° mm; DC>10.00 mm: CHW ± 0.05x45° mm.

Product	DC (mm)	CHW (mm)	DCON MS (mm)	APMX (mm)	OAL (mm)	NOF
S9022.0	2.00	0.08	3.00	6.00	38.0	2
S9022.5	2.50	0.08	3.00	9.00	38.0	2
S9023.0	3.00	0.08	3.00	12.00	38.0	2
S9024.0	4.00	0.08	4.00	14.00	50.0	2
S9025.0	5.00	0.13	5.00	16.00	50.0	2
S9026.0	6.00	0.13	6.00	19.00	57.0	2
S9027.0	7.00	0.13	8.00	19.00	63.0	2
S9028.0	8.00	0.13	8.00	19.00	63.0	2
S9029.0	9.00	0.13	10.00	21.00	72.0	2
S90210.0	10.00	0.18	10.00	22.00	72.0	2
S90212.0	12.00	0.20	12.00	25.00	73.0	2
S90214.0	14.00	0.20	14.00	30.00	83.0	2
S90216.0	16.00	0.20	16.00	32.00	92.0	2
S90218.0	18.00	0.20	18.00	32.00	92.0	2
S90220.0	20.00	0.30	20.00	38.00	104.0	2

S922



2-Flute Solid Carbide End Mill

Medium cut length, 2-flute design with 30° helix provides high rigidity for milling standard slots. Cylindrical shank for cutting diameter up to 5 mm. TiALN coating for higher temperature resistance and longer tool life.

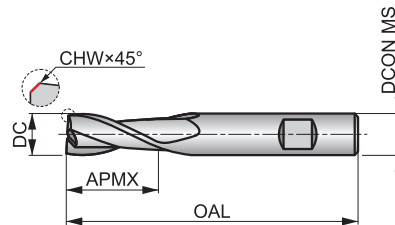

HM	N	NOF 2
	λ 30°	γ 12°
DIN 6535HB	TiALN	DC h10



Workpiece material group suitability, starting values for cutting speed (m/min) and Alpha Code. Tables with feed per tooth and correction factors can be found starting from page 237.

P1.1 ■ 132 K	P1.2 ■ 148 K	P1.3 ■ 153 K	P2.1 ■ 113 K	P2.2 ■ 100 K	P2.3 ■ 88 J	P3.1 ■ 98 K	P3.2 ■ 79 J	P3.3 ■ 67 J	P4.1 ■ 59 J	P4.2 ■ 50 J	P4.3 ▣ 41 J	K1.1 ■ 100 K	K1.2 ■ 74 K
K1.3 ■ 56 K	K2.1 ■ 107 K	K2.2 ■ 87 K	K2.3 ■ 70 J	K3.1 ■ 95 K	K3.2 ■ 72 K	K3.3 ■ 59 J	K4.1 ■ 88 J	K4.2 ■ 67 J	K4.3 ■ 49 J	K4.4 ■ 42 J	K4.5 ■ 35 J	K5.1 ■ 100 J	K5.2 ■ 75 J
K5.3 ■ 58 J	N1.1 ▣ 1296 K	N1.2 ▣ 1222 K	N1.3 ■ 149 K	N2.1 ■ 149 K	N2.2 ■ 133 K	N2.3 ■ 96 K	N3.1 ■ 156 K	N3.2 ■ 91 K	N3.3 ▣ 147 K	N4.1 ▣ 156 K	N4.2 ▣ 160 K	N4.3 ▣ 164 K	S1.1 ■ 47 J
S1.2 ▣ 45 J	S1.3 ▣ 20 J												

DCON MS tolerance h6; DC≤10.00 mm: CHW ± 0.03X45° mm; DC>10.00 mm: CHW ± 0.05X45° mm.
Products from this series are also available in set. Please see S991.

Product	DC (mm)	CHW (mm)	DCON MS (mm)	APMX (mm)	OAL (mm)	NOF
S9222.0 ¹⁾	2.00	0.08	3.00	6.00	38.0	2
S9222.5 ¹⁾	2.50	0.08	3.00	9.00	38.0	2
S9223.0 ¹⁾	3.00	0.08	3.00	12.00	38.0	2
S9224.0 ¹⁾	4.00	0.08	4.00	14.00	50.0	2
S9225.0 ¹⁾	5.00	0.13	5.00	16.00	50.0	2
S9226.0	6.00	0.13	6.00	19.00	57.0	2
S9227.0	7.00	0.13	8.00	19.00	63.0	2
S9228.0	8.00	0.13	8.00	19.00	63.0	2
S9229.0	9.00	0.13	10.00	21.00	72.0	2
S92210.0	10.00	0.18	10.00	22.00	72.0	2
S92212.0	12.00	0.20	12.00	25.00	73.0	2
S92214.0	14.00	0.20	14.00	30.00	83.0	2
S92216.0	16.00	0.20	16.00	32.00	92.0	2
S92218.0	18.00	0.20	18.00	32.00	92.0	2
S92220.0	20.00	0.30	20.00	38.00	104.0	2

¹⁾ Cylindrical shank.

S903



3-Flute Solid Carbide End Mill

Medium cut length, 3-flute design with 30° helix and provides high rigidity for milling standard slots.

HM	N	NOF 3
	λ 30°	γ 12°
DIN 6535HA	Bright	DC h10

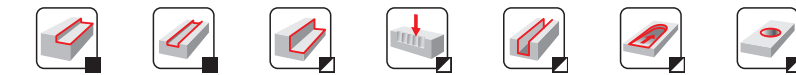
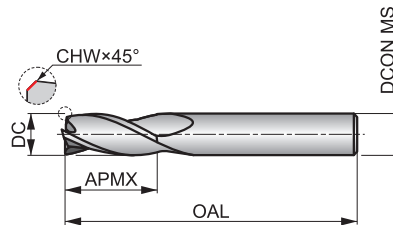

Workpiece material group suitability, starting values for cutting speed (m/min) and Alpha Code. Tables with feed per tooth and correction factors can be found starting from page 237.

P1.1 ■ 106 J	P1.2 ■ 119 J	P1.3 ■ 123 J	P2.1 ■ 91 J	P2.2 ■ 80 J	P2.3 ▣ 71 I	P3.1 ■ 66 J	P3.2 ■ 53 I	P3.3 ▣ 45 I	P4.1 ■ 40 I	P4.2 ▣ 34 I	K1.1 ■ 80 J	K1.2 ▣ 59 J	K1.3 ▣ 44 J
K2.1 ■ 98 J	K2.2 ■ 80 J	K2.3 ▣ 64 I	K3.1 ■ 87 J	K3.2 ■ 67 J	K3.3 ▣ 54 I	K4.1 ■ 81 I	K4.2 ■ 61 I	K4.3 ▣ 45 I	K4.4 ▣ 38 I	K4.5 ▣ 32 I	K5.1 ■ 91 I	K5.2 ■ 69 I	K5.3 ▣ 53 I
N1.1 ▣ 355 K	N1.2 ■ 267 K	N1.3 ■ 179 K	N2.1 ■ 179 J	N2.2 ▣ 160 J	N2.3 ▣ 115 J	N3.1 ■ 187 J	N3.2 ■ 109 J	N3.3 ■ 56 J	N4.1 ▣ 187 J	N4.2 ▣ 72 J	S1.1 ■ 38 I	S1.2 ▣ 36 I	S1.3 ▣ 43 I

DCON MS tolerance h6; DC≤9.00 mm: CHW ± 0.03X45° mm; DC>9.00 mm: CHW ± 0.05X45° mm.

Product	DC (mm)	CHW (mm)	DCON MS (mm)	APMX (mm)	OAL (mm)	NOF
S9032.0	2.00	0.08	3.00	6.00	38.0	3
S9032.5	2.50	0.08	3.00	9.00	38.0	3
S9033.0	3.00	0.08	3.00	12.00	38.0	3
S9034.0	4.00	0.08	4.00	14.00	50.0	3
S9035.0	5.00	0.13	5.00	16.00	50.0	3
S9036.0	6.00	0.13	6.00	19.00	57.0	3
S9037.0	7.00	0.13	8.00	19.00	63.0	3
S9038.0	8.00	0.13	8.00	19.00	63.0	3
S9039.0	9.00	0.13	10.00	21.00	72.0	3
S90310.0	10.00	0.20	10.00	22.00	72.0	3
S90312.0	12.00	0.20	12.00	25.00	73.0	3
S90314.0	14.00	0.20	14.00	30.00	83.0	3
S90316.0	16.00	0.20	16.00	32.00	92.0	3
S90318.0	18.00	0.20	18.00	32.00	92.0	3
S90320.0	20.00	0.30	20.00	38.00	104.0	3

S933



3-Flute Solid Carbide End Mill

Medium cut length, 3-flute design with 30° helix provides high rigidity for milling standard slots. Cylindrical shank for cutting diameter up to 5 mm. TiALN coating for higher temperature resistance and longer tool life.

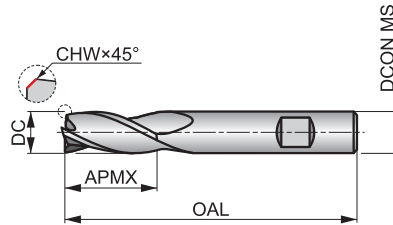

HM	N	NOF 3
	λ 30°	γ 12°
DIN 6535HB	TiALN	DC h10
	DORMER	



Workpiece material group suitability, starting values for cutting speed (m/min) and Alpha Code. Tables with feed per tooth and correction factors can be found starting from page 237.

P1.1 ■ 132 J	P1.2 ■ 148 J	P1.3 ■ 153 J	P2.1 ■ 113 J	P2.2 ■ 100 J	P2.3 ■ 88 I	P3.1 ■ 98 J	P3.2 ■ 79 I	P3.3 ■ 67 I	P4.1 ■ 59 I	P4.2 ■ 50 I	P4.3 ▣ 41 I	K1.1 ■ 100 J	K1.2 ■ 74 J
K1.3 ■ 56 J	K2.1 ■ 107 J	K2.2 ■ 87 J	K2.3 ■ 70 I	K3.1 ■ 95 J	K3.2 ■ 72 J	K3.3 ■ 59 I	K4.1 ■ 88 I	K4.2 ■ 67 I	K4.3 ■ 49 I	K4.4 ■ 42 I	K4.5 ■ 35 I	K5.1 ■ 100 I	K5.2 ■ 75 I
K5.3 ■ 58 I	N1.1 ▣ 296 K	N1.2 ▣ 222 K	N1.3 ■ 149 K	N2.1 ■ 149 J	N2.2 ■ 133 J	N2.3 ■ 96 J	N3.1 ■ 156 J	N3.2 ■ 91 J	N3.3 ▣ 47 J	N4.1 ▣ 156 J	N4.2 ▣ 60 J	N4.3 ▣ 64 J	S1.1 ■ 47 I
S1.2 ▣ 45 I	S1.3 ▣ 20 I												

DCON MS tolerance h6; DC≤9.00 mm: CHW ± 0.03X45° mm; DC>9.00 mm: CHW ± 0.05X45° mm.
Products from this series are also available in set. Please see S991.

Product	DC (mm)	CHW (mm)	DCON MS (mm)	APMX (mm)	OAL (mm)	NOF
S9332.0 ¹⁾	2.00	0.08	3.00	6.00	38.0	3
S9332.5 ¹⁾	2.50	0.08	3.00	9.00	38.0	3
S9333.0 ¹⁾	3.00	0.08	3.00	12.00	38.0	3
S9334.0 ¹⁾	4.00	0.08	4.00	14.00	50.0	3
S9335.0 ¹⁾	5.00	0.13	5.00	16.00	50.0	3
S9336.0	6.00	0.13	6.00	19.00	57.0	3
S9337.0	7.00	0.13	8.00	19.00	63.0	3
S9338.0	8.00	0.13	8.00	19.00	63.0	3
S9339.0	9.00	0.13	10.00	21.00	72.0	3
S93310.0	10.00	0.20	10.00	22.00	72.0	3
S93312.0	12.00	0.20	12.00	25.00	73.0	3
S93314.0	14.00	0.20	14.00	30.00	83.0	3
S93316.0	16.00	0.20	16.00	32.00	92.0	3
S93318.0	18.00	0.20	18.00	32.00	92.0	3
S93320.0	20.00	0.30	20.00	38.00	104.0	3

¹⁾ Cylindrical shank.

S904



4-Flute Solid Carbide End Mill

Medium cut length, 4-flute design with 30° helix provides high rigidity for milling standard slots.

HM	N	NOF 4
	λ 30°	γ 12°
DIN 6535HA	Bright	DC h12
	DORMER	

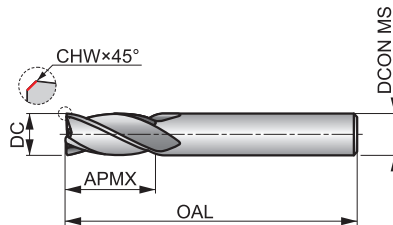

Workpiece material group suitability, starting values for cutting speed (m/min) and Alpha Code. Tables with feed per tooth and correction factors can be found starting from page 237.

P1.1 ■ 106 J	P1.2 ■ 119 J	P1.3 ■ 123 J	P2.1 ■ 91 J	P2.2 ■ 80 J	P2.3 ▧ 71 I	P3.1 ■ 66 J	P3.2 ■ 53 I	P3.3 ▧ 45 I	P4.1 ■ 40 I	P4.2 ▧ 34 I	P4.3 ▧ 18 I	K1.1 ■ 80 J	K1.2 ▧ 59 I
K1.3 ▧ 44 J	K2.1 ■ 98 J	K2.2 ■ 80 J	K2.3 ▧ 64 I	K3.1 ■ 87 J	K3.2 ■ 67 J	K3.3 ▧ 54 I	K4.1 ■ 81 I	K4.2 ■ 61 I	K4.3 ▧ 45 I	K4.4 ▧ 38 I	K4.5 ▧ 32 I	K5.1 ■ 91 I	K5.2 ■ 69 I
K5.3 ▧ 53 I	N1.1 ▧ 355 J	N1.2 ■ 267 J	N1.3 ■ 179 J	N2.1 ■ 179 J	N2.2 ▧ 160 J	N2.3 ▧ 115 J	N3.1 ■ 187 J	N3.2 ■ 109 J	N3.3 ■ 56 J	N4.1 ▧ 187 J	N4.2 ▧ 172 J	S1.1 ■ 38 I	S1.2 ▧ 36 I
S1.3 ▧ 43 I	S2.1 ▧ 40 I	S2.2 ▧ 35 I	S3.1 ▧ 30 I	S3.2 ▧ 25 I	S4.1 ▧ 23 I	S4.2 ▧ 20 I							

DCON MS tolerance h6; DC≤9.00 mm: CHW ± 0.03X45° mm; DC>9.00 mm: CHW ± 0.05X45° mm.

Product	DC (mm)	CHW (mm)	DCON MS (mm)	APMX (mm)	OAL (mm)	NOF
S9042.0	2.00	0.08	3.00	6.00	38.0	4
S9042.5	2.50	0.08	3.00	9.00	38.0	4
S9043.0	3.00	0.08	3.00	12.00	38.0	4
S9044.0	4.00	0.08	4.00	14.00	50.0	4
S9045.0	5.00	0.13	5.00	16.00	50.0	4
S9046.0	6.00	0.13	6.00	19.00	57.0	4
S9047.0	7.00	0.13	8.00	19.00	63.0	4
S9048.0	8.00	0.13	8.00	19.00	63.0	4
S9049.0	9.00	0.13	10.00	21.00	72.0	4
S90410.0	10.00	0.20	10.00	22.00	72.0	4
S90412.0	12.00	0.20	12.00	25.00	73.0	4
S90414.0	14.00	0.20	14.00	30.00	83.0	4
S90416.0	16.00	0.20	16.00	32.00	92.0	4
S90418.0	18.00	0.20	18.00	32.00	92.0	4
S90420.0	20.00	0.30	20.00	38.00	104.0	4



S944



4-Flute Solid Carbide End Mill

Medium cut length, 4-flute design with 30° helix provides high rigidity for milling standard slots. Cylindrical shank for cutting diameter up to 5 mm. TiALN coating for higher temperature resistance and longer tool life.

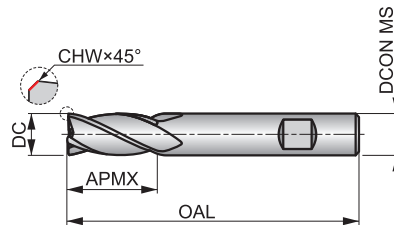

HM	N	NOF 4
	λ 30°	γ 12°
DIN 6535HB	TiALN	DC h12
	DORMER	



Workpiece material group suitability, starting values for cutting speed (m/min) and Alpha Code. Tables with feed per tooth and correction factors can be found starting from page 237.

P1.1 ■ 132 J	P1.2 ■ 148 J	P1.3 ■ 153 J	P2.1 ■ 113 J	P2.2 ■ 100 J	P2.3 ■ 88 I	P3.1 ■ 98 J	P3.2 ■ 79 I	P3.3 ■ 67 I	P4.1 ■ 59 I	P4.2 ■ 50 I	P4.3 ■ 41 I	K1.1 ■ 100 J	K1.2 ■ 74 J
K1.3 ■ 56 J	K2.1 ■ 107 J	K2.2 ■ 87 J	K2.3 ■ 70 I	K3.1 ■ 95 J	K3.2 ■ 72 J	K3.3 ■ 59 I	K4.1 ■ 88 I	K4.2 ■ 67 I	K4.3 ■ 49 I	K4.4 ■ 42 I	K4.5 ■ 35 I	K5.1 ■ 100 I	K5.2 ■ 75 I
K5.3 ■ 58 I	N1.1 ■ 1296 J	N1.2 ■ 222 J	N1.3 ■ 149 J	N2.1 ■ 149 J	N2.2 ■ 133 J	N2.3 ■ 96 J	N3.1 ■ 156 J	N3.2 ■ 91 J	N3.3 ■ 47 J	N4.1 ■ 156 J	N4.2 ■ 60 J	N4.3 ■ 64 J	S1.1 ■ 47 I
S1.2 ■ 45 I	S1.3 ■ 45 I	S2.1 ■ 60 I	S2.2 ■ 49 I	S3.1 ■ 45 I	S3.2 ■ 35 I	S4.1 ■ 35 I	S4.2 ■ 28 I						

DCON MS tolerance h6; DC≤9.00 mm: CHW ± 0.03X45° mm; DC>9.00 mm: CHW ± 0.05X45° mm.
Products from this series are also available in set. Please see S991.

Product	DC (mm)	CHW (mm)	DCON MS (mm)	APMX (mm)	OAL (mm)	NOF
S9442.0 ¹⁾	2.00	0.08	3.00	6.00	38.0	4
S9442.5 ¹⁾	2.50	0.08	3.00	9.00	38.0	4
S9443.0 ¹⁾	3.00	0.08	3.00	12.00	38.0	4
S9444.0 ¹⁾	4.00	0.08	4.00	14.00	50.0	4
S9445.0 ¹⁾	5.00	0.13	5.00	16.00	50.0	4
S9446.0	6.00	0.13	6.00	19.00	57.0	4
S9447.0	7.00	0.13	8.00	19.00	63.0	4
S9448.0	8.00	0.13	8.00	19.00	63.0	4
S9449.0	9.00	0.13	10.00	21.00	72.0	4
S94410.0	10.00	0.20	10.00	22.00	72.0	4
S94412.0	12.00	0.20	12.00	25.00	73.0	4
S94414.0	14.00	0.20	14.00	30.00	83.0	4
S94416.0	16.00	0.20	16.00	32.00	92.0	4
S94418.0	18.00	0.20	18.00	32.00	92.0	4
S94420.0	20.00	0.30	20.00	38.00	104.0	4

¹⁾ Cylindrical shank.



S991



Set of Solid Carbide End Mills

Sets of solid carbide End Mills with TiALN coating. Range of S922, S933 or S944 (2, 3 or 4 flute). Sets contain Ø3, 4, 5, 6, 8 and 10 mm. Carried in a plastic container for good overview.

A=Styles in Set, B=No. in Set, C=Diameters in Set.

Product	A	B	C
S991SET922	S922	6	3.00 mm, 4.00 mm, 5.00 mm, 6.00 mm, 8.00 mm, 10.00 mm
S991SET933	S933	6	3.00 mm, 4.00 mm, 5.00 mm, 6.00 mm, 8.00 mm, 10.00 mm
S991SET944	S944	6	3.00 mm, 4.00 mm, 5.00 mm, 6.00 mm, 8.00 mm, 10.00 mm

SOLID HM MILLS – FEED PER TOOTH TABLE

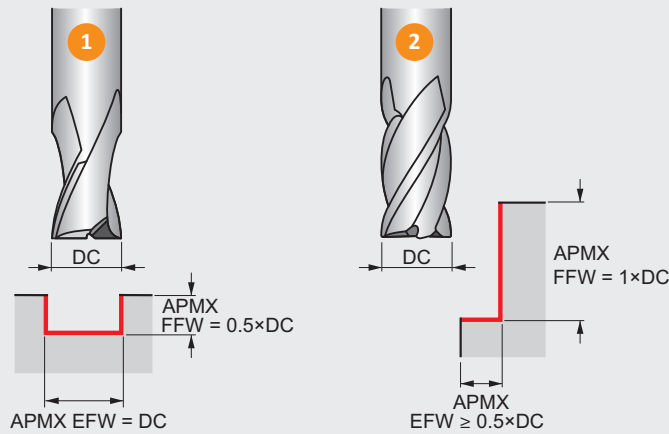

Feed per tooth (f_z in mm/rev) depending on the working conditions it might be necessary to adjust these values $\pm 25\%$.

ONLY if plunging into solid material with a centre cutting end mill the values in this table should be considered as f_n (feed per revolution).

How to use this table to find the feed per tooth (f_z):

1. Find your Alpha Code on the product page (example: 199K, "K" is the Alpha Code).
2. Find the closest diameter for your cutting application in the top row of the table.
3. Find your Alpha Code in the left column of the table.
4. The intersection (cell) of the Diameter and Alpha Code is the feed per tooth (f_z).

**FOR SOLID
CARBIDE
MILLING
CUTTERS ONLY**

		\varnothing DC [mm]																
		1.00	2.00	3.00	4.00	5.00	6.00	7.00	8.00	9.00	10.00	12.00	14.00	16.00	18.00	20.00	22.00	25.00
Feed rates	A	0.002	0.003	0.004	0.005	0.006	0.007	0.008	0.009	0.010	0.011	0.014	0.015	0.017	0.019	0.021	0.025	0.028
	B	0.002	0.003	0.004	0.005	0.006	0.007	0.008	0.009	0.010	0.011	0.014	0.015	0.017	0.019	0.021	0.025	0.028
	C	0.002	0.003	0.004	0.005	0.006	0.007	0.008	0.009	0.010	0.011	0.014	0.015	0.017	0.019	0.021	0.025	0.028
	D	0.002	0.003	0.004	0.005	0.007	0.008	0.009	0.010	0.011	0.012	0.014	0.015	0.017	0.019	0.021	0.025	0.028
	E	0.002	0.003	0.004	0.008	0.009	0.012	0.013	0.014	0.015	0.016	0.019	0.021	0.024	0.026	0.028	0.030	0.034
	F	0.002	0.003	0.006	0.010	0.013	0.016	0.017	0.019	0.021	0.022	0.026	0.029	0.032	0.035	0.039	0.042	0.047
	G	0.002	0.005	0.008	0.014	0.018	0.022	0.024	0.026	0.028	0.031	0.035	0.040	0.044	0.048	0.053	0.057	0.064
	I	0.003	0.006	0.011	0.019	0.024	0.030	0.032	0.036	0.039	0.042	0.049	0.054	0.061	0.066	0.073	0.079	0.088
	J	0.004	0.009	0.014	0.026	0.033	0.041	0.044	0.048	0.053	0.057	0.066	0.074	0.083	0.090	0.099	0.107	0.120
	K	0.006	0.012	0.019	0.035	0.044	0.054	0.059	0.064	0.070	0.076	0.088	0.098	0.110	0.120	0.132	0.142	0.160
	N	0.008	0.016	0.025	0.047	0.058	0.072	0.078	0.086	0.094	0.101	0.117	0.131	0.146	0.160	0.175	0.189	0.212
	O	0.010	0.021	0.034	0.062	0.078	0.096	0.104	0.114	0.124	0.135	0.156	0.174	0.195	0.213	0.233	0.252	0.283
	P	0.014	0.028	0.045	0.083	0.104	0.128	0.138	0.152	0.166	0.180	0.207	0.231	0.259	0.283	0.311	0.335	0.376
	R	0.018	0.037	0.060	0.110	0.138	0.170	0.184	0.202	0.221	0.239	0.276	0.308	0.345	0.377	0.414	0.446	0.501
	S	0.024	0.049	0.080	0.147	0.183	0.226	0.245	0.269	0.294	0.318	0.367	0.410	0.459	0.502	0.550	0.593	0.667

SOLID HM MILLS – FEED PER TOOTH TABLE

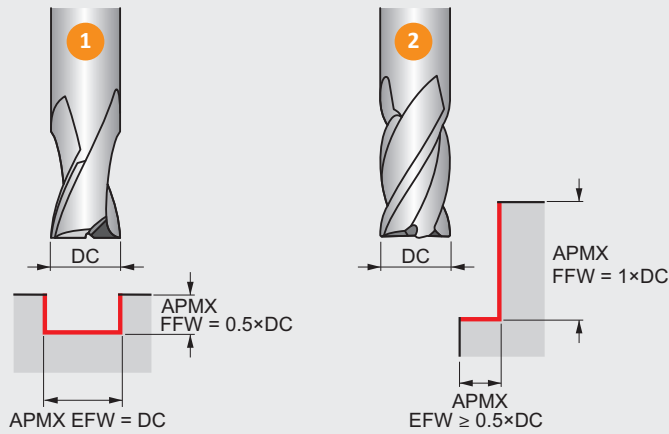

Feed per tooth (IPT or inch/tooth) depending on the working conditions it might be necessary to adjust these values $\pm 25\%$.

ONLY if plunging into solid material with a centre cutting end mill the values in this table should be considered as IPR (feed in inch per revolution).

How to use this table to find the feed per tooth (IPT):

1. Find your Alpha Code on the product page (example: 653K, "K" is the Alpha Code).
2. Find the closest diameter for your cutting application in the top row of the table.
3. Find your Alpha Code in the left column of the table.
4. The intersection (cell) of the Diameter and Alpha Code is the feed per tooth (IPT).



**FOR SOLID
CARBIDE
MILLING
CUTTERS ONLY**

		\varnothing DC [inch]															
		1/16	3/32	1/8	5/32	3/16	7/32	1/4	5/16	3/8	7/16	1/2	9/16	5/8	3/4	7/8	1
		.0625	.0938	.1250	.1563	.1875	.2188	.2500	.3125	.3750	.4375	.5000	.5625	.6250	.7500	.8750	1.0000
Feed rates	A	.0001	.0001	.0002	.0002	.0002	.0002	.0003	.0003	.0004	.0005	.0005	.0006	.0007	.0008	.0010	.0011
	B	.0001	.0001	.0002	.0002	.0002	.0002	.0003	.0003	.0004	.0005	.0005	.0006	.0007	.0008	.0010	.0011
	C	.0001	.0001	.0002	.0002	.0002	.0002	.0003	.0003	.0004	.0005	.0005	.0006	.0007	.0008	.0010	.0011
	D	.0001	.0001	.0002	.0002	.0002	.0003	.0004	.0004	.0004	.0005	.0006	.0006	.0007	.0008	.0010	.0011
	E	.0001	.0001	.0002	.0003	.0004	.0004	.0005	.0006	.0006	.0007	.0007	.0009	.0009	.0011	.0012	.0013
	F	.0001	.0002	.0002	.0004	.0005	.0006	.0006	.0007	.0009	.0009	.0011	.0012	.0013	.0015	.0017	.0019
	G	.0002	.0002	.0004	.0006	.0007	.0007	.0009	.0010	.0012	.0013	.0015	.0016	.0017	.0020	.0023	.0025
	I	.0002	.0003	.0005	.0007	.0009	.0011	.0012	.0014	.0016	.0018	.0020	.0022	.0024	.0028	.0031	.0035
	J	.0003	.0004	.0007	.0010	.0012	.0014	.0017	.0019	.0022	.0024	.0027	.0030	.0032	.0037	.0043	.0047
	K	.0004	.0006	.0009	.0014	.0016	.0019	.0022	.0025	.0029	.0032	.0036	.0040	.0043	.0050	.0056	.0063
	N	.0005	.0007	.0011	.0019	.0022	.0025	.0029	.0034	.0038	.0043	.0048	.0053	.0057	.0066	.0075	.0083
	O	.0006	.0010	.0015	.0024	.0029	.0034	.0039	.0045	.0051	.0057	.0063	.0070	.0076	.0088	.0100	.0111
	P	.0008	.0014	.0020	.0033	.0038	.0045	.0052	.0060	.0068	.0076	.0084	.0094	.0100	.0117	.0133	.0148
	R	.0011	.0018	.0027	.0043	.0051	.0060	.0069	.0080	.0091	.0101	.0112	.0125	.0134	.0156	.0177	.0197
	S	.0015	.0024	.0036	.0058	.0067	.0080	.0091	.0106	.0120	.0135	.0149	.0166	.0178	.0207	.0236	.0263

SOLID HM MILLS – CORRECTION FACTORS



1 Slot Milling

Correction factors for cutting speed v_c and feed per tooth f_z for slot milling operations at different depths of cut.

APMX FFW / DC	25 %	50 %	100 %	150 %
	1.25	1.00	0.75	0.50
	1.25	1.00	0.75	0.50

2 Shoulder Milling

Correction factors for cutting speed v_c and feed per tooth f_z for square shoulder milling with <50% radial immersion.

APMX EFW / DC	5 %	10 %	15 %	20 %	25 %	30 %	40 %	≥ 50 %
	1.48	1.35	1.27	1.22	1.19	1.16	1.11	1.00
	2.29	1.67	1.40	1.25	1.15	1.09	1.02	1.00

We recommend to avoid milling with 50% radial immersion.

SOLID HSS MILLS – FEED PER TOOTH TABLE

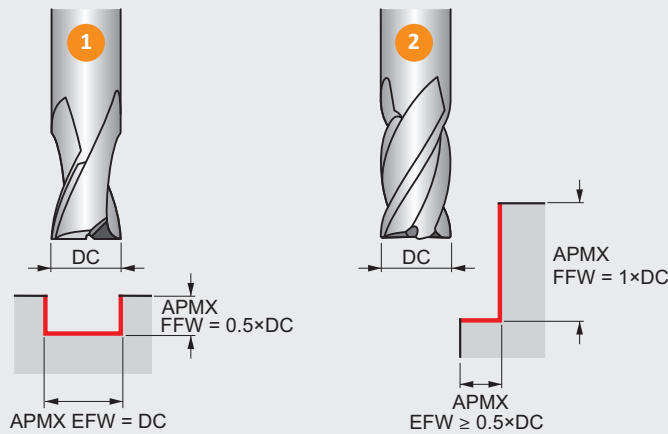

Feed per tooth (f_z in mm/rev) depending on the working conditions it might be necessary to adjust these values $\pm 25\%$.

ONLY if plunging into solid material with a centre cutting end mill the values in this table should be considered as f_n (feed per revolution).

How to use this table to find the feed per tooth (f_z):

1. Find your Alpha Code on the product page (example: 48C, "C" is the Alpha Code).
2. Find the closest diameter for your cutting application in the top row of the table.
3. Find your Alpha Code in the left column of the table.
4. The intersection (cell) of the Diameter and Alpha Code is the feed per tooth (f_z).

**FOR HSS,
HSS-E AND
HSS-E-PM MILLING
CUTTERS ONLY**

		ϕ DC [mm]																		
		1.00	2.00	3.00	4.00	5.00	6.00	8.00	10.00	12.00	16.00	20.00	25.00	28.00	32.00	36.00	40.00	63.00	80.00	100.00
Feed rates	A	0.002	0.003	0.003	0.005	0.005	0.005	0.007	0.009	0.011	0.015	0.018	0.023	0.027	0.030	0.033	0.034	0.043	0.045	0.042
	B	0.003	0.004	0.004	0.006	0.006	0.007	0.009	0.012	0.014	0.018	0.023	0.029	0.033	0.038	0.041	0.043	0.054	0.057	0.052
	C	0.004	0.004	0.005	0.007	0.008	0.008	0.011	0.015	0.017	0.023	0.029	0.036	0.042	0.047	0.051	0.054	0.067	0.071	0.065
	D	0.005	0.006	0.006	0.009	0.010	0.010	0.014	0.018	0.022	0.029	0.036	0.045	0.052	0.059	0.064	0.067	0.084	0.089	0.082
	E	0.006	0.007	0.008	0.011	0.012	0.013	0.017	0.023	0.027	0.036	0.045	0.056	0.065	0.074	0.080	0.084	0.105	0.111	0.102
	F	0.007	0.008	0.010	0.013	0.014	0.016	0.020	0.028	0.032	0.043	0.054	0.067	0.078	0.089	0.096	0.101	0.126	0.133	0.122
	G	0.009	0.010	0.012	0.016	0.017	0.019	0.024	0.033	0.039	0.052	0.065	0.081	0.094	0.107	0.115	0.121	0.151	0.160	0.147
	H	0.010	0.012	0.014	0.019	0.021	0.022	0.029	0.040	0.047	0.062	0.078	0.097	0.112	0.128	0.138	0.145	0.181	0.192	0.176
	I	0.012	0.015	0.017	0.023	0.025	0.027	0.035	0.048	0.056	0.075	0.093	0.116	0.135	0.153	0.166	0.174	0.218	0.230	0.212
	J	0.015	0.017	0.020	0.027	0.030	0.032	0.042	0.057	0.067	0.090	0.112	0.139	0.162	0.184	0.199	0.209	0.261	0.276	0.254

This table is valid for end mills and shell mills.

SOLID HSS MILLS – FEED PER TOOTH TABLE

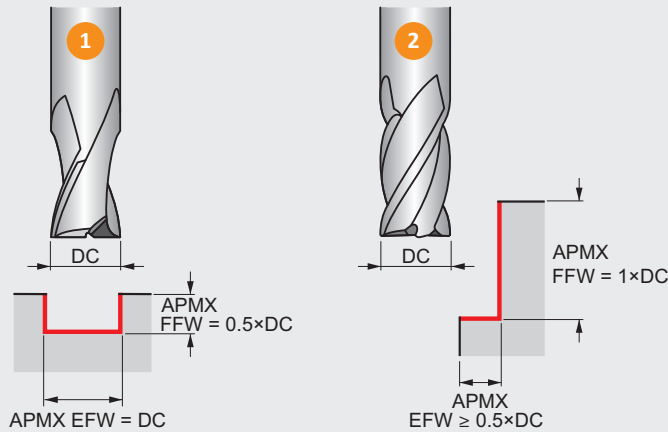

Feed per tooth (IPT or inch/tooth) depending on the working conditions it might be necessary to adjust these values $\pm 25\%$.

ONLY if plunging into solid material with a centre cutting end mill the values in this table should be considered as IPR (feed in inch per revolution).

How to use this table to find the feed per tooth (IPT):

1. Find your Alpha Code on the product page (example: 157C, "C" is the Alpha Code).
2. Find the closest diameter for your cutting application in the top row of the table.
3. Find your Alpha Code in the left column of the table.
4. The intersection (cell) of the Diameter and Alpha Code is the feed per tooth (IPT).

**FOR HSS,
HSS-E AND
HSS-E-PM MILLING
CUTTERS ONLY**



		ø DC [inch]																			
		1/16	3/32	1/8	5/32	3/16	7/32	1/4	5/16	3/8	7/16	1/2	9/16	5/8	3/4	7/8	1	1 1/8	1 1/4	1 1/2	
Feed rates		.0625	.0938	.1250	.1563	.1875	.2188	.2500	.3125	.3750	.4375	.5000	.5625	.6250	.7500	.8750	1,0000	1,1250	1,2500	1,5000	
	A	.0001	.0001	.0001	.0002	.0002	.0002	.0002	.0003	.0004	.0004	.0005	.0006	.0006	.0007	.0008	.0009	.0011	.0012	.0013	.0015
	B	.0001	.0002	.0002	.0002	.0002	.0002	.0003	.0004	.0004	.0005	.0006	.0007	.0007	.0009	.0011	.0012	.0014	.0015	.0017	.0019
	C	.0002	.0002	.0002	.0003	.0003	.0003	.0004	.0004	.0005	.0006	.0007	.0008	.0009	.0011	.0013	.0015	.0017	.0019	.0021	.0023
	D	.0002	.0002	.0002	.0004	.0004	.0004	.0004	.0006	.0007	.0008	.0009	.0010	.0011	.0013	.0017	.0019	.0021	.0023	.0025	.0027
	E	.0002	.0003	.0003	.0004	.0005	.0005	.0006	.0007	.0008	.0010	.0011	.0013	.0014	.0017	.0020	.0023	.0027	.0029	.0031	.0033
	F	.0003	.0003	.0004	.0005	.0006	.0006	.0007	.0008	.0010	.0012	.0014	.0016	.0017	.0020	.0024	.0028	.0032	.0035	.0039	.0042
	G	.0004	.0004	.0005	.0006	.0007	.0007	.0008	.0009	.0012	.0014	.0017	.0019	.0020	.0024	.0030	.0033	.0039	.0042	.0046	.0049
	H	.0004	.0005	.0006	.0007	.0008	.0008	.0009	.0011	.0014	.0017	.0020	.0022	.0024	.0029	.0035	.0040	.0046	.0050	.0054	.0058
	I	.0005	.0006	.0007	.0009	.0010	.0010	.0011	.0014	.0017	.0020	.0024	.0027	.0030	.0035	.0043	.0048	.0056	.0060	.0064	.0068
J	.0006	.0007	.0008	.0011	.0012	.0012	.0014	.0017	.0020	.0024	.0028	.0032	.0035	.0042	.0051	.0058	.0067	.0072	.0077	.0080	

This table is valid for end mills and shell mills.

SOLID HSS MILLS – CORRECTION FACTORS



1 Slot Milling

Correction factors for cutting speed v_c and feed per tooth f_z for slot milling operations at different depths of cut.

APMX FFW / DC	25%	50%	100%	150%
	1.25	1.00	0.75	0.50
	1.25	1.00	0.75	0.50

2 Shoulder Milling

Correction factors for cutting speed v_c and feed per tooth f_z for square shoulder milling with < 50% radial immersion.

APMX EFW / DC	5%	10%	15%	20%	25%	30%	40%	≥ 50%
	1.48	1.35	1.27	1.22	1.19	1.16	1.11	1.00
	2.29	1.67	1.40	1.25	1.15	1.09	1.02	1.00

We recommend to avoid milling with 50% radial immersion.



SOLID MILLS – TECHNICAL INFORMATION



HSS MATERIALS

HSS materials

Cobalt High Speed Steel	<div style="border: 1px solid black; border-radius: 5px; padding: 2px; display: inline-block;">HSS-E</div>	<p>This high speed steel contains cobalt for increased hot hardness. The composition of HSCo is a good combination of toughness and hardness. It has good machinability and good wear resistance, which makes it usable for drills, taps, milling cutters and reamers.</p>
Sintered Cobalt High Speed Steel	<div style="border: 1px solid black; border-radius: 5px; padding: 2px; display: inline-block;">HSS-E PM</div>	<p>Sintered Cobalt High Speed Steel (HSCo powder metal) is a substrate produced using powder metallurgy technology. Tools using substrates produced by this method exhibit superior toughness and grindability.</p>

	Grade	Hardness (HV10)	C %	W %	Mo %	Cr %	V %	Co %	Tool Material
HSS-E	M35	830 – 870	0.93	6.4	5.0	4.2	1.8	4.8	HSCO
	M42	870 – 960	1.08	1.5	9.4	3.9	1.2	8.0	
HSS-E PM	ASP 2017	860 – 900	0.8	3.0	3.0	4.0	1.0	8.0	HSCO Powder Metal
	ASP 2030	870 – 910	1.28	6.4	5.0	4.2	3.1	8.5	
	ASP 2052	870 – 910	1.6	10.5	2.0	4.8	5.0	8.0	

HM materials

<p>Carbide Materials (or Hard Materials)</p>	<p>HM</p>	<p>A sintered powder metallurgy substrate, consisting of a metallic carbide composite with binder metal. The most central raw material is tungsten carbide (WC). Tungsten carbide contributes to the hardness of the material. Tantalum carbide (TaC), titanium carbide (TiC) and niobium carbide (NbC) complements WC and adjusts the properties to what is desired. These three materials are called cubic carbides. Cobalt (Co) acts as a binder and keeps the material together.</p> <p>Carbide materials are often characterised by high compression strength, high hardness and therefore high wear resistance, but also by limited flexural strength and toughness. Carbide is used in taps, reamers, milling cutters, drills and thread milling cutters.</p>
---	-----------	--

Properties	HSS materials	HM materials	K10/30F (often used for solid tools)
Hardness (HV30)	800 – 950	1300 – 1800	1600
Density (g/cm ³)	8.0 – 9.0	7.2 – 15.0	14.45
Compressive strength (N/mm ²)	3000 – 4000	3000 – 8000	6250
Flexural strength, (bending) (N/mm ²)	2500 – 4000	1000 – 4700	4300
Heat resistance (°C)	550	1000	900
E-module (KN/mm ²)	260 – 300	460 – 630	580
Grain size (µm)	–	0.2 – 10.0	0.8

The combination of hard particle (WC) and binder metal (Co) give the following changes in characteristics.

Characteristic	Higher WC content give	Higher Co content give
Hardness	Higher hardness	Lower hardness
Compressive strength (CS)	Higher CS	Lower CS
Bending strength (BS)	Lower BS	Higher BS

Grain size also influences the material properties. Small grain sizes means higher hardness and coarse grains give more toughness.

SURFACE TREATMENTS / SURFACE COATINGS

Surface Treatments

Bright (uncoated)		Bright finish (uncoated surface) improves chip flow in soft or non-ferrous materials and maintains sharp cutting edges in abrasive materials.
--------------------------	---	---

Surface Coatings

Titanium Aluminium Nitride Coatings (TiAlN)		Titanium Aluminium Nitride is a multi layer ceramic coating applied by PVD coating technology, which exhibits high toughness and oxidation stability. These properties make it ideal for higher speeds and feeds, while at the same time improving tool life. TiAlN is used in drilling, tapping, and milling applications and can be suitable for use when machining without coolant.
--	---	--

Surface treatment / Coating properties examples

Surface Treatments	Color	Coating material	Hardness [HV]	Thickness [µm]	Coating structure	Frict. coeff. against steel	Max. appl. temp. [°C]
	Black grey	TiAlN	3300	3	Nano structured	0.3 – 0.35	900

Nomenclature

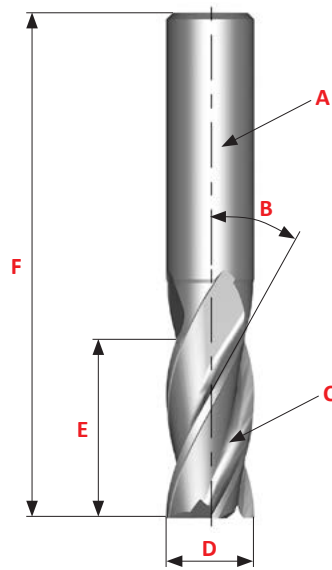

- A Shank
- B Helix Angle
- C Flute
- D Outside Diameter (DC)
- E Cutting Length (AP)
- F Overall Length (OAL)

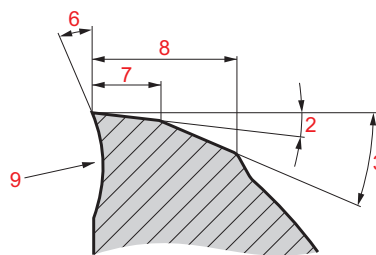
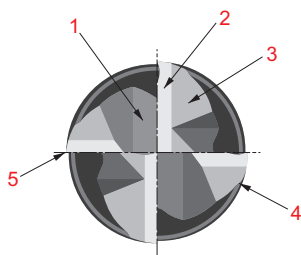

- 1 Gash
- 2 Primary Relief Angle
- 3 Secondary Relief Angle
- 4 Heel
- 5 Cutting Edge
- 6 Rake Angle
- 7 Width of Primary Relief Land
- 8 Width of Secondary Relief Land
- 9 Undercut Face

Features Of The End Mill - Choosing The Number Of Flutes (NOF)

Number of flutes should be determined by:

- Milled material
- Dimension of workpiece
- Milling conditions

2 Flutes	3 Flutes	4 Flutes (or multi-flutes)
LOW	DEFLECTION STRENGTH	HIGH
BIG	CHIP SPACE	SMALL
<ul style="list-style-type: none"> • Large chip space. • Easy chip ejection. • Good for slot milling. • Good for heavy duty milling. • Less rigidity due to small section area. • Lower quality surface finish 	<ul style="list-style-type: none"> • Chip space almost as large as for 2 flutes. • Larger section area - higher rigidity than 2 flutes • Improved surface finish 	<ul style="list-style-type: none"> • Highest rigidity. • Largest section area – small chip space. • Gives best surface finish. • Recommended for profiling, side milling and shallow slotting.

Features Of The End Mill – Helix Angle

Increasing the number of flutes makes the load on the single tooth more homogeneous and consequently, this allows for a better finish. But with a high helix angle, the load (FV) along the cutter axis is increased too.

A high FV can give:

- Load problems on the spindle bearings
- Cutter movement along the spindle axis. To avoid this problem it is necessary to use Weldon or better Mechanical or Hydraulical Tool-holder.



General hints on milling

Milling is a process of generating machined surfaces by progressively removing a predetermined amount of material or stock from the workpiece at a relatively slow rate of movement or feed by a milling cutter rotating at a comparatively high speed. The characteristic feature of the milling process is that each milling cutter tooth removes its share of the stock in the form of small individual chips.

Type of milling cutters

The three basic milling operations are shown below: (A) peripheral milling, (B) face milling and (C) end milling.

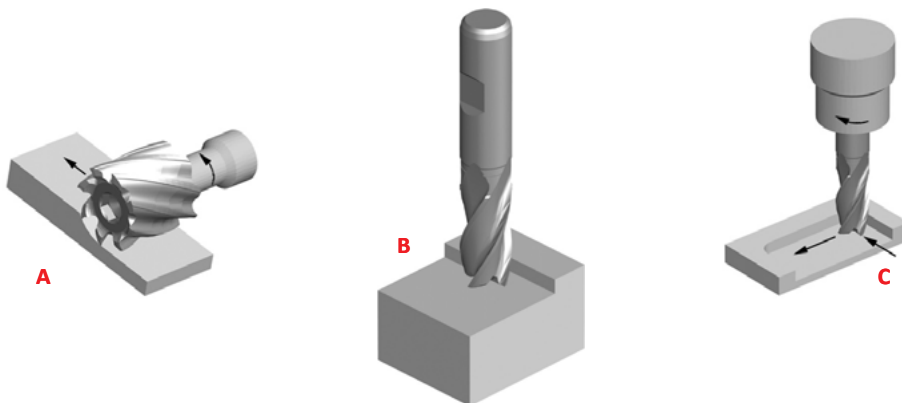

In peripheral milling (also called slab milling), the axis of cutter rotation is parallel to the workpiece surface to be machined. The cutter has a number of teeth along its circumference, each tooth acting like a single-point cutting tool called a plain mill. Cutters used in peripheral milling may have straight or helical teeth generating an orthogonal or oblique cutting action.





In face milling, the cutter is mounted on a spindle with an axis of rotation perpendicular to the workpiece surface. The milled surface results from the action of cutting edges located on the periphery and face of the cutter.

In end milling, the cutter generally rotates on an axis vertical to the workpiece. It can be tilted to machine tapered surfaces. Cutting teeth are located on both the end face of the cutter and the periphery of the cutter body.

MILLING TECHNICAL INFO

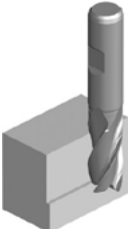
Different applications for end mills

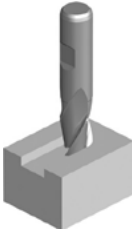
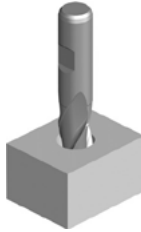
The Metal Removal Rate (MRR) and the applications are strongly related. For each different application we have a different MRR that increases with the engagement section of the cutter on the workpiece. The recent Dormer catalogue was produced with simple icons that show the different applications.

Side Milling	Face Milling	Slot Milling	Plunge Milling	Ramping
				
The radial depth of cut should be less than 0.25 of the diameter of the end mill.	The radial depth of cut should be no more than 0.9 of the diameter, axial depth of cut less than 0.1 of the diameter.	Machining of a slot for keyways. The radial depth of cut is equal to the diameter on the end mill.	It is possible to drill the workpiece with an end mill only with the cutting centre. In this operation the feed has to be halved.	Both axial and radial entering into the workpiece.

Milling Effectively

Types Of Cuts

Climb Milling Versus Conventional Milling

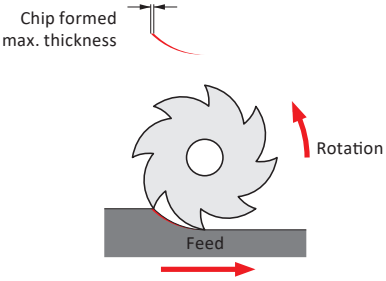
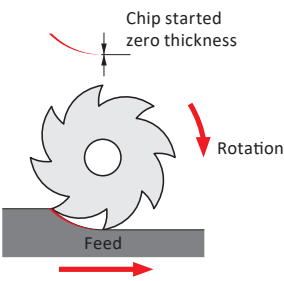
CLIMB MILLING	CONVENTIONAL MILLING
 <p>Chip formed max. thickness</p> <p>Rotation</p> <p>Feed</p>	 <p>Chip started zero thickness</p> <p>Rotation</p> <p>Feed</p>
<p>In climb milling, the cutter revolves in the same direction as the table feed. The tooth meets the work at the top of the cut, producing the thickest part of the chip first. In horizontal applications the resultant force created by climb milling can act as a clamping force, acting towards the machine table.</p> <p>It is important to make sure that the machine tool has no leadscrew backlash. Normally climb milling improves product surface finish and increases tool life.</p>	<p>In conventional milling, the cutter revolves opposite to the direction of table feed. Therefore the width of the chip starts at zero and increases to a maximum at the end of the cut. This can lead to accelerated tool wear under some conditions. Conventional milling may be advantageous when milling hot rolled steel, surface hardened and steels with a surface scale.</p>

PERIPHERAL (CYLINDRICAL, SLAB) MILLING

Peripheral Milling The milling of a surface which is parallel to the end mill axis.

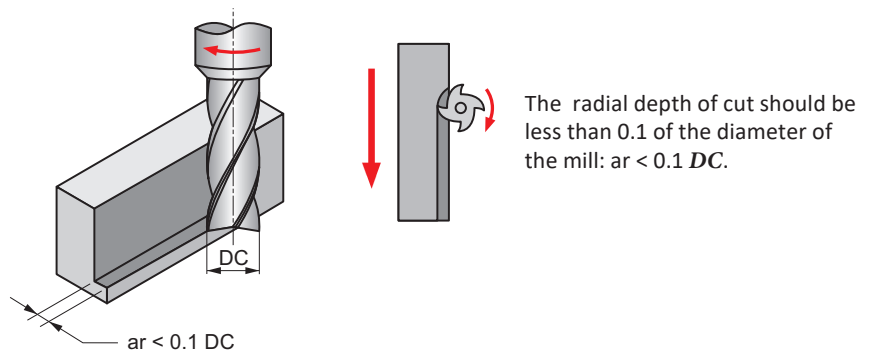

Plunge Milling

The direct movement between the workpiece and the centre line of the end mill when the end mill sinks directly into the workpiece.

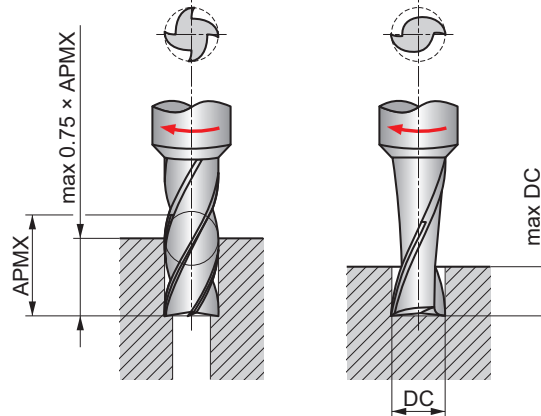

In order to be able to “drill,” i.e. mill with axial feed, an end mill must have an end face cutting edge that goes all the way to the centre. An example of such a solid drilling operation is keyway milling in the middle of a shaft.

In boring, the depth of a hole may be up to 75 % of the cutting edge length. In solid drilling, however, it should not exceed 0.5 – 1.0 *DC*.

Slot Milling

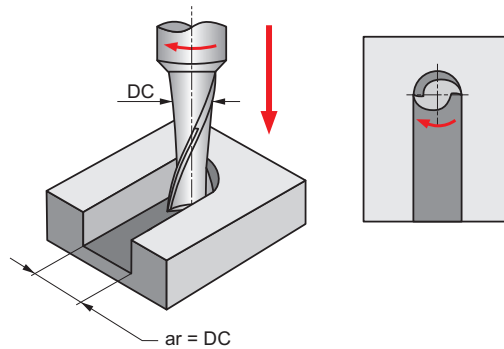

The radial depth of cut is equal to the diameter of the mill: $a_r = DC$.

All slotting applications are a combination of conventional and climb milling. Refer to adjacent section.

End Mill Selection

Utilize the shortest possible tool available for the application with the largest diameter permissible and the shortest flute length as depth of cut allows. Extra length end mills have excessive overhang, thus a reduction in feed up to 25 % may be required. Stub length end mills, due to their short overall and flute length, have more rigidity, thus an increase in feed rates of up to 25 % may be required.

Speeds

Solid Carbide end mills must be run at higher speeds than High Speed Steel end mills. Many times, lighter cuts at higher speeds can improve the finish of the workpiece.

When the application is a slotting cut, the speed should be reduced by approximately 20 %. Speeds should be decreased when milling hard or tough materials or when taking heavy cuts. Speeds should be increased when milling softer materials or when taking lighter cuts. Speeds should also be increased for finishing cuts.

Coolants

Coolants are recommended when milling mild steel and high temperature alloys. The purpose of the coolant media is to direct the chips away from the cutting tool and workpiece. This prevents damage to the cutting edges due to recutting the chips. When machining titanium, coolant flow must be heavy and directed at the area of cut to prevent overheating and assist in chip removal.

OPERATING FORMULAS

Milling Terminology/Operating Formulas

The following terms and formulas can be used to determine the appropriate operating parameters.

Formulas (Metric)			Terms	Formulas (Imperial)		
$V_c = \frac{n \times DC \times \pi}{1000}$	v_c	[m/min]	Cutting speed	<i>SFM</i>	[ft/min]	$SFM = \frac{RPM \times DC \times \pi}{12}$
	n	[rev/min]	Spindle speed	<i>RPM</i>	[rev/min]	
$n = \frac{v_c \times 1000}{DC \times \pi}$	V_f	[mm/min]	Feed rate	<i>IPM</i>	[in/min]	$RPM = \frac{SFM \times 12}{DC \times \pi}$
	f_z	[mm/z]	Feed per tooth	<i>IPT</i>	[in/T]	
$V_f = f_z \times z \times n$	<i>DC</i>	[mm]	Cutting diameter	<i>DC</i>	[in]	$IPM = IPT \times T \times RPM$
$f_z = \frac{V_f}{z \times n}$	z	[-]	Number of teeth	<i>T</i>	[-]	$IPT = \frac{IPM}{T \times RPM}$
$Q = \frac{V_f \times APMX FFW \times APMX EFW}{1000}$	<i>APMX FFW</i>	[mm]	Depth of cut	<i>DOC</i>	[in]	$MRR = IPM \times DOC \times WOC$
	<i>APMX EFW</i>	[mm]	Width of cut	<i>WOC</i>	[in]	
	<i>Q</i>	[cm ³ /min]	Metal removal rate	<i>MRR</i>	in ³ /min	

TROUBLESHOOTING

Problem	Solution	
Chipping of the Cutting Edge	<ul style="list-style-type: none"> • Try air blow or coolant • Reduce depth of cut • Check amount of wear on collet • Reduce feed per tooth • If wet cutting, change to dry cutting 	<ul style="list-style-type: none"> • Check tool runout • Improve the stability of the work-holding
Extreme Flank Wear	<ul style="list-style-type: none"> • Use coated end mill • If conventional milling, change to climb • If using water soluble cutting fluid, change to non-water soluble cutting fluid • Use a tool with a larger helix angle 	<ul style="list-style-type: none"> • If conventional milling, change to climb
Vibration/Chattering	<ul style="list-style-type: none"> • Use larger diameter end mill • Increase feed per tooth • Increase helix angle • Reduce length of flutes or overhang • Reduce cutting speed 	<ul style="list-style-type: none"> • Check or change the holder • Increase number of flutes • Tighten chuck or use stronger chuck
Deflection	<ul style="list-style-type: none"> • Reduce depth of cut • Increase feed per tooth • Increase helix angle • If using water soluble cutting fluid, change to non-water soluble cutting fluid 	<ul style="list-style-type: none"> • Use larger diameter end mill • Reduce length of flutes or overhang • If using 2-flute type, change to 4-flute type • If climb milling, change to conventional milling
Poor Surface Finish	<ul style="list-style-type: none"> • Reduce end mill runout • Increase cutting speed • Reduce feed per tooth • Increase helix angle • Increase number of flutes 	<ul style="list-style-type: none"> • Increase volume of air or cutting fluid • Reduce depth of cut • If dry cutting, change to wet cutting
Waviness	<ul style="list-style-type: none"> • Reduce helix angle • Check end mill runout • Reduce depth of cut • Check or change the holder 	
End Mill Fracturing	<ul style="list-style-type: none"> • Reduce depth of cut • Reduce feed per tooth • Reduce length of flutes or overhang • If chip jamming occurs, reduce the number of flutes 	
Poor Chip Disposal	<ul style="list-style-type: none"> • Use air blow • Reduce depth of cut • Reduce feed per tooth • Reduce the number of flutes • Increase volume of air or cutting fluid 	<ul style="list-style-type: none"> • Increase cutting speed
Burring Workpiece Chipping	<ul style="list-style-type: none"> • Reduce helix angle • Reduce feed per tooth • Reduce depth of cut 	
Chip Welding	<ul style="list-style-type: none"> • Use coolant • Use coated end mill • Increase volume of cutting fluid • Increase helix angle 	

ROTARY BURRS



CARBIDE ROTARY BURRS

Our range of carbide rotary burrs is a high quality and comprehensive program. This includes a variety of designs and shapes to offer an ideal option for the majority of applications in all major industry segments.

FEATURES AND BENEFITS

- The combination of premium grade materials for both the shank and head, with the precise production process, results in the creation of a consistent and secure program of tools.
- Each CUT STYLE has been designed to be the first choice for high performance machining in the relevant material. This includes steels (ST CUT), stainless

steels (VA CUT), non-ferrous materials and plastics (ALUMINIUM CUT), superalloys (AS CUT), fibreglass and composite materials (GRP CUT), and general machining (DC CUT).

SHANK

- Toughened and hardened steel shanks
- Provides rigidity and strength
- Prevents bending and reduces vibration, resulting in improved tool life
- Ground to h6 (carbide) and h7 (steel) for improved holding

BRAZING

- Special brazing elements provide excellent braze strength
- Excellent impact strength to withstand high forces
- Able to withstand higher temperature without failing

CUT STYLES



ST

ST CUT

First choice for high performance machining of **Steels**

- Material specific chip breaker design for higher machining output on steel parts
- Positive geometry, ensures smooth surface finish
- Creates less temperature which helps increase tool life



VA

VA CUT

First choice for high performance machining of **Stainless steels**

- Sharp cutting geometry, reducing the onset of work-hardening
- Increases metal removal rate



AL

ALUMINIUM CUT

First choice for **Non ferrous materials and Plastics**

- High helix and large flute volume for rapid metal removal

CARBIDE ROTARY BURRS



BALL NOSE GEOMETRY

- Skip flute grinding
- Increased strength at the centre
- Reduced chance of swarf congestion
- Improved cutting action closer to the centre



Skip

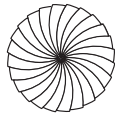

Normal

TiAlN COATING

- Increased tool life in difficult conditions
- Reduced friction improves swarf evacuation
- Helps resist “built-up edge” common with cutting tools with small flute volumes

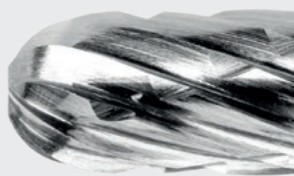

AS

AS CUT

First choice for **Superalloys**

- Ergonomic
- High quality surface finish
- Fast and smooth cutting action

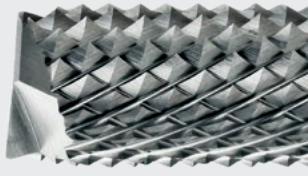

GRP

GRP CUT

First choice for **Fibreglass and Composite materials**

- Available with Drill Point and End Mill styles
- Designed to reduce splintering and improve entry and exit surface quality



DC

DOUBLE CUT

First choice for **General machining**

- Improves ease of control
- Increases metal removal rate

CARBIDE ROTARY BURRS

FOR BOLT REMOVAL

A specially designed range of burrs to prepare the surface of broken bolts to improve drill location and prevent damaging the threaded hole and component.

FEATURES AND BENEFITS

- Specific diameters and cutting lengths to suit various thread diameters
- Long reach and reduced shanks for easy access
- Developed cutting geometry for machining high tensile materials
- Reduces potential damage to existing threaded holes
- Improves drill location, ensuring damaged bolt is drilled on centre
- Prevents potential scrapage of component
- Highly consistent quality

OPERATIONS

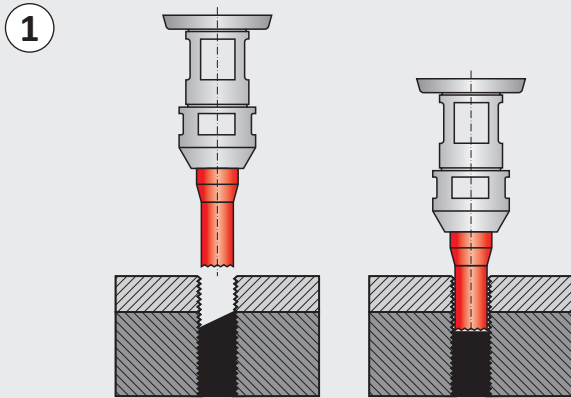

CUT STYLES

PLAIN CYLINDER WITH END CUT

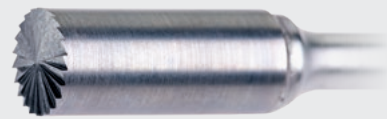

150° COUNTERSINK



HOW TO USE THE TOOLS

- Choose the correct size burr for the broken bolt
- Use a right-handed die grinder
- Ensure the burr is perpendicular to the broken bolt
- Grind the broken surface flat – Operation ①
- Grind into the prepared surface to form a countersink location at the centre point of the bolt – Operation ②

1

P811



3

Solid Carbide Jobber Drill, Bright Finish

Improved wear resistance for increased productivity and extended tool life. A 120°, 4-facet point helps with self-centering and reduces cutting forces. Can be used with all CNC machine applications.

2

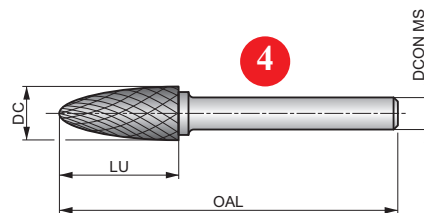

4

HM	F Bright
DC	

5



6

Workpiece material group suitability. Recommended operating speed (RPM) on page 267.

P1.1	P1.2	P1.3	P2.1	P2.2	P2.3	P3.1	P3.2	P3.3	P4.1	P4.2	P4.3	M1.1	M1.2
M2.1	M2.2	M2.3	M3.1	M3.2	M3.3	M4.1	M4.2	K1.1	K1.2	K1.3	K2.1	K2.2	K2.3
K3.1	K3.2	K3.3	K4.1	K4.2	K4.3	K4.4	K4.5	K5.1	K5.2	K5.3	N3.1	N3.2	N3.3
S1.1	S1.2	S1.3	S2.1	S2.2	S3.1	S3.2	S4.1	S4.2	H1.1	H2.1	H2.2	H3.1	H3.2
H4.1	H4.2												

7

DC≤6.00 mm: DCON MS tolerance h6; DC>6.00 mm: Brazed on steel shank with DCON MS tolerance h7.
Products from this series are also available in set. Please see P880 or P890.

8

Product	DC (mm)	DCON MS (mm)	LU (mm)	OAL (mm)
P8113.0X3.0	3.00	3.00	14.00	38.0
P8116.3X3.0	6.30	3.00	12.70	45.0
P8116.0X6.0	6.00	6.00	18.00	50.0
P8118.0X6.0	8.00	6.00	20.00	65.0
P8119.6X6.0	9.60	6.00	19.00	64.0
P81112.7X6.0	12.70	6.00	25.00	70.0
P81116.0X6.0	16.00	6.00	25.00	70.0

9



ROTARY BURRS – PAGE OVERVIEW

Pos.	Description	Pos.	Description
1	Designation of rotary burrs	6	Deburring operations
2	Product description	7	Material group recommendations
3	Illustrative picture	8	Product code
4	Schematic drawing of tool	9	Product dimensions
5	Product features		

ROTARY BURRS – ICONS OVERVIEW













General Icons

	Primary use
	Possible use

Material Code (BMC)

HM	Hard Material (Solid Carbide)
-----------	-------------------------------



Burr Shape

A 	Cylinder Shape without endcut	F 	Ball Nosed Tree Shape	L 	Ball Nosed Cone Shape
B 	Cylinder Shape with endcut	G 	Pointed Tree Shape	M 	Cone Shape
C 	Ball Nosed Cylinder Shape	H 	Flame Shape	N 	Inverted Cone Shape
D 	Ball Shape	J 	60° Countersink Shape		
E 	Oval Shape	K 	90° Countersink Shape		

Burr End Shot





	Drill Point Burr End
	End Cut Burr End
	End Mill Burr End

Coating







	Bright (uncoated)
	Titanium Aluminium Nitride Coating

ROTARY BURRS – ICONS OVERVIEW

Application Angle

 60° Countersink	 Drill Point 135°	 Spot Drill Point 150°
 90° Countersink	 Drill Point 180°	













Burr Cut Flute Style (BTC)

 Double Cut Geometry	 Aluminium Cut Geometry	 Superalloy Cut Geometry
 Steel Cut Geometry	 Fibreglass and Composite Materials Cut Geometry	
 Stainless Steel Cut Geometry	 Bolt Removal Cut Geometry	

Basic Standard Group (BSG)

 Dormer Standards
--

Operations Deburring

 Deburring - Bolt removal operation 1	 Curved surface deburring and carving	 Inverted back deburring
 Deburring - Bolt removal operation 2	 Fillet radii deburring	 Plain surface deburring
 Closed groove deburring and carving	 Free hand deburring and carving	 Shoulder deburring
 Composite fibre routing	 Chamfer deburring	 V-groove deburring

Other Icons

 Bolt size
--

ROTARY BURRS – TOOL MATERIALS NAVIGATOR

HM materials

<p>Carbide Materials (or Hard Materials)</p>		<p>A sintered powder metallurgy substrate, consisting of a metallic carbide composite with binder metal. The most central raw material is tungsten carbide (WC). Tungsten carbide contributes to the hardness of the material. Tantalum carbide (TaC), titanium carbide (TiC) and niobium carbide (NbC) complements WC and adjusts the properties to what is desired. These three materials are called cubic carbides. Cobalt (Co) acts as a binder and keeps the material together.</p> <p>Carbide materials are often characterised by high compression strength, high hardness and therefore high wear resistance, but also by limited flexural strength and toughness. Carbide is used in taps, reamers, milling cutters, drills and thread milling cutters.</p>
---	---	--

ROTARY BURRS – SURFACE AND TREATMENTS COATINGS NAVIGATOR

Surface Treatments

<p>Bright (uncoated)</p>		<p>Bright finish (uncoated surface) improves chip flow in soft or non-ferrous materials and maintains sharp cutting edges in abrasive materials.</p>
-------------------------------------	---	--

Surface Coatings

<p>Titanium Aluminium Nitride Coating (TiAlN)</p>		<p>Titanium Aluminium Nitride is a multi layer ceramic coating applied by PVD coating technology, which exhibits high toughness and oxidation stability. These properties make it ideal for higher speeds and feeds, while at the same time improving tool life. TiAlN is used in drilling, tapping, and milling applications and can be suitable for use when machining without coolant.</p>
--	---	---

Material code (BMC)	HM	HM	HM	HM	HM	HM	HM	HM	HM	HM	HM	HM	HM	
	Burr Shape	A	A	B	B	C	C	D	D	E	F	F	G	G
	Coating													
Application angle														
Burr Type Code (BTC)	DC	DC	DC	DC	DC	DC	DC	DC	DC	DC	DC	DC	DC	
Basic standard group (BSG)														
Product Family Code														
		P801	P801C	P803	P803C	P805	P805C	P807	P807C	P809	P811	P811C	P813	P813C
		3.00 - 16.00	3.00 - 12.70	3.00 - 16.00	3.00 - 12.70	3.00 - 16.00	3.00 - 12.70	3.00 - 16.00	3.00 - 12.70	3.00 - 16.00	3.00 - 16.00	3.00 - 12.70	3.00 - 16.00	3.00 - 12.70
	268	269	270	271	272	273	274	275	276	277	278	279	280	
P	P1	■	■	■	■	■	■	■	■	■	■	■	■	■
	P2	■	■	■	■	■	■	■	■	■	■	■	■	■
	P3	■	■	■	■	■	■	■	■	■	■	■	■	■
	P4	■	■	■	■	■	■	■	■	■	■	■	■	■
M	M1	■	■	■	■	■	■	■	■	■	■	■	■	■
	M2	■	■	■	■	■	■	■	■	■	■	■	■	■
	M3	■	■	■	■	■	■	■	■	■	■	■	■	■
	M4	■	■	■	■	■	■	■	■	■	■	■	■	■
K	K1	■	■	■	■	■	■	■	■	■	■	■	■	■
	K2	■	■	■	■	■	■	■	■	■	■	■	■	■
	K3	■	■	■	■	■	■	■	■	■	■	■	■	■
	K4	■	■	■	■	■	■	■	■	■	■	■	■	■
	K5	■	■	■	■	■	■	■	■	■	■	■	■	■
N	N1													
	N2													
	N3	■	■	■	■	■	■	■	■	■	■	■	■	■
	N4													
	N5													
S	S1	■	■	■	■	■	■	■	■	■	■	■	■	■
	S2	■	■	■	■	■	■	■	■	■	■	■	■	■
	S3	■	■	■	■	■	■	■	■	■	■	■	■	■
	S4	■	■	■	■	■	■	■	■	■	■	■	■	■
H	H1	■	■	■	■	■	■	■	■	■	■	■	■	■
	H2	■	■	■	■	■	■	■	■	■	■	■	■	■
	H3	■	■	■	■	■	■	■	■	■	■	■	■	■
	H4	■	■	■	■	■	■	■	■	■	■	■	■	■

■ Primary use ◻ Possible use

	HM H	HM H	HM L	HM L	HM M	HM J	HM K	HM N	HM A	HM B	HM C	HM D	HM E	HM F	HM G
	Bright	TIAIN	Bright	TIAIN	Bright	Bright 60°	Bright 90°	Bright	Bright	Bright	Bright	Bright	Bright	Bright	Bright
	DC	DC	DC	DC	DC	DC	DC	DC	ST	ST	ST	ST	ST	ST	ST
	DORMER	DORMER	DORMER	DORMER	DORMER	DORMER	DORMER	DORMER	DORMER	DORMER	DORMER	DORMER	DORMER	DORMER	DORMER
	P815	P815C	P821	P821C	P823	P817	P819	P825	P701	P703	P705	P707	P709	P711	P713
	3.00 - 16.00	8.00 - 12.70	3.00 - 16.00	3.00 - 12.70	3.00 - 16.00	3.00 - 16.00	3.00 - 16.00	3.00 - 16.00	6.00 - 12.70	6.00 - 12.70	6.00 - 12.70	6.00 - 12.70	12.70	6.00 - 12.70	6.00 - 12.70
	281	282	283	284	285	286	287	288	289	290	291	292	293	294	295
P1	■	■	■	■	■	■	■	■	■	■	■	■	■	■	■
P2	■	■	■	■	■	■	■	■	■	■	■	■	■	■	■
P3	■	■	■	■	■	■	■	■	■	■	■	■	■	■	■
P4	■	■	■	■	■	■	■	■	■	■	■	■	■	■	■
M1	■	■	■	■	■	■	■	■							
M2	■	■	■	■	■	■	■	■							
M3	■	■	■	■	■	■	■	■							
M4	■	■	■	■	■	■	■	■							
K1	■	■	■	■	■	■	■	■							
K2	■	■	■	■	■	■	■	■							
K3	■	■	■	■	■	■	■	■							
K4	■	■	■	■	■	■	■	■							
K5	■	■	■	■	■	■	■	■							
N1															
N2															
N3	■	■	■	■	■	■	■	■							
N4															
N5															
S1	■	■	■	■	■	■	■	■							
S2	■	■	■	■	■	■	■	■							
S3	■	■	■	■	■	■	■	■							
S4	■	■	■	■	■	■	■	■							
H1	■	■	■	■	■	■	■	■							
H2	■	■	■	■	■	■	■	■							
H3	■	■	■	■	■	■	■	■							
H4	■	■	■	■	■	■	■	■							



Material code (BMC)	HM	HM	HM	HM	HM	HM	HM	HM	HM	HM	HM	HM	HM	
	Burr Shape	H	L	A	C	D	E	F	G	H	L	A	B	C
		Burr end shot												
	Coating		Bright	Bright	Bright	Bright	Bright	Bright	Bright	Bright	Bright	Bright	Bright	Bright
Application angle														
	Burr Type Code (BTC)	ST	ST	VA	VA	VA	VA	VA	VA	VA	VA	AL	AL	AL
Basic standard group (BSG)		DORMER	DORMER	DORMER	DORMER	DORMER	DORMER	DORMER	DORMER	DORMER	DORMER	DORMER	DORMER	DORMER
	Product Family Code													
		P715	P721	P601	P605	P607	P609	P611	P613	P615	P621	P831	P833	P835
		8.00 - 12.70	10.00 - 12.70	3.00 - 12.70	3.00 - 12.70	3.00 - 12.70	8.00 - 12.70	3.00 - 12.70	6.00 - 12.70	8.00 - 12.70	8.00 - 12.70	6.00 - 12.70	6.00 - 12.70	6.00 - 12.70
P	P1	■	■											
	P2	■	■											
	P3	■	■											
	P4	■	■											
M	M1		■	■	■	■	■	■	■	■				
	M2		■	■	■	■	■	■	■	■				
	M3		■	■	■	■	■	■	■	■				
	M4		■	■	■	■	■	■	■	■				
K	K1									▣				
	K2													
	K3													
	K4			▣	▣	▣	▣	▣	▣	▣	▣			
	K5													
N	N1										■	■	■	
	N2										■	■	■	
	N3										▣	▣	▣	
	N4										■	■	■	
	N5													
S	S1										▣	▣	▣	
	S2													
	S3													
	S4													
H	H1													
	H2													
	H3													
	H4													

■ Primary use ▣ Possible use

	HM D Bright AL DORMER	HM F Bright AL DORMER	HM L Bright AL DORMER	HM A Bright AS DORMER	HM C Bright AS DORMER	HM D Bright AS DORMER	HM E Bright AS DORMER	HM F Bright AS DORMER	HM G Bright AS DORMER	HM H Bright AS DORMER	HM L Bright AS DORMER	HM M Bright AS DORMER	HM Bright GRP DORMER	HM Bright 135° GRP DORMER	HM Bright 180° GRP DORMER	HM Bright BR DORMER
				NEW	NEW	NEW	NEW	NEW	NEW	NEW	NEW	NEW				NEW
	P837	P841	P842	P501	P505	P507	P509	P511	P513	P515	P521	P523	P843	P844	P100	
	6.00 - 12.70	6.00 - 12.70	6.00 - 12.70	3.00	3.00	3.00	3.00	3.00	3.00	3.00	3.00	3.00	3.00 - 8.00	3.00 - 8.00	4.90 - 10.70	
	309	310	311	312	313	314	315	316	317	318	319	320	321	322	323	
P1																■
P2																■
P3																■
P4																■
M1																■
M2																■
M3				☑	☑	☑	☑	☑	☑	☑	☑	☑				■
M4				☑	☑	☑	☑	☑	☑	☑	☑	☑				■
K1																
K2																
K3																
K4																
K5																
N1	■	■	■													
N2	■	■	■													
N3	☑	☑	☑													
N4	■	■	■										■	■		
N5																
S1	☑	☑	☑	■	■	■	■	■	■	■	■	■				
S2				■	■	■	■	■	■	■	■	■				
S3				■	■	■	■	■	■	■	■	■				
S4				■	■	■	■	■	■	■	■	■				
H1																
H2																
H3																
H4																

Material code (BMC)	HM																				
Burr Shape																					
Burr end shot																					
Coating	Bright																				
Application angle	150°																				
Burr Type Code (BTC)	BR																				
Basic standard group (BSG)	DORNER																				
Product Family Code	NEW	NEW																			
	P101	P880	P890																		
	4.90 - 10.70	Set	Set																		
	📖 325	📖 326	📖 327																		
P	P1	■																			
	P2	■																			
	P3	■																			
	P4	■																			
M	M1	■																			
	M2	■																			
	M3	■																			
	M4																				
K	K1																				
	K2																				
	K3																				
	K4																				
	K5																				
N	N1																				
	N2																				
	N3																				
	N4																				
	N5																				
S	S1																				
	S2																				
	S3																				
	S4																				
H	H1																				
	H2																				
	H3																				
	H4																				



RECOMMENDED OPERATING SPEED

		RPM							
		DC (mm)							
		3	6	8	10	12	16	20	
AL	DC	ISO	RPM						
			DC (mm)						
P	min.	64 000	32 000	24 000	20 000	16 000	12 000	10 000	
	max.	83 000	42 000	32 000	25 000	21 000	16 000	13 000	
M	min.	45 000	23 000	17 000	14 000	12 000	9 000	7 000	
	max.	64 000	32 000	24 000	20 000	16 000	12 000	10 000	
K	min.	58 000	29 000	22 000	19 000	15 000	11 000	9 000	
	max.	77 000	39 000	29 000	23 000	20 000	15 000	12 000	
N	min.	64 000	32 000	24 000	20 000	16 000	12 000	10 000	
	max.	96 000	48 000	36 000	29 000	24 000	18 000	15 000	
S	min.	45 000	23 000	17 000	14 000	12 000	9 000	7 000	
	max.	58 000	29 000	22 000	18 000	15 000	11 000	9 000	
H	min.	51 000	26 000	20 000	16 000	13 000	10 000	8 000	
	max.	71 000	36 000	27 000	22 000	18 000	14 000	11 000	

		RPM					
		DC (mm)					
		3	6	8	10	12	
ST	BR	ISO	RPM				
			DC (mm)				
P	min.	100 000	65 000	60 000	55 000	35 000	
	max.	60 000	45 000	35 000	30 000	20 000	

		RPM					
		DC (mm)					
		3	6	8	10	12	
VA	BR	ISO	RPM				
			DC (mm)				
M	min.	100 000	65 000	60 000	55 000	35 000	
	max.	60 000	30 000	25 000	20 000	15 000	

		RPM		
		DC (mm)		
		3	6	8
GRP	ISO	RPM		
		DC (mm)		
N4	min.	25 000	20 000	18 000
	max.	30 000	25 000	22 000

		RPM
		DC (mm)
		3
AS	ISO	RPM
		DC (mm)
S	min.	60 000
	max.	80 000

P801



Rotary Burr - Cylinder without endcut, Shape A, Bright Finish

DC double cut flute style with close spaced edges for trimming and deburring surfaces. Carbide design for cutting diameter up to 6 mm; above 6 mm carbide head with toughened and hardened steel shank.

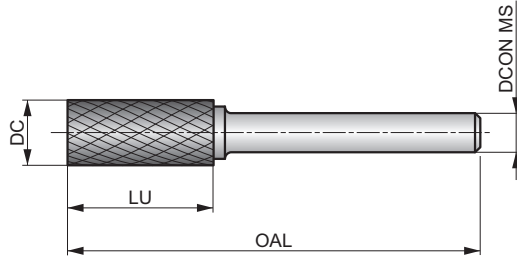

HM	A	Bright
DC	DORMER	



Workpiece material group suitability. Recommended operating speed (RPM) on page 267.

P1.1	P1.2	P1.3	P2.1	P2.2	P2.3	P3.1	P3.2	P3.3	P4.1	P4.2	P4.3	M1.1	M1.2
M2.1	M2.2	M2.3	M3.1	M3.2	M3.3	M4.1	M4.2	K1.1	K1.2	K1.3	K2.1	K2.2	K2.3
K3.1	K3.2	K3.3	K4.1	K4.2	K4.3	K4.4	K4.5	K5.1	K5.2	K5.3	N3.1	N3.2	N3.3
S1.1	S1.2	S1.3	S2.1	S2.2	S3.1	S3.2	S4.1	S4.2	H1.1	H2.1	H2.2	H3.1	H3.2
H4.1	H4.2												

DC ≤ 6.00 mm: DCON MS tolerance h6; DC > 6.00 mm: Brazed on steel shank with DCON MS tolerance h7.
 Products from this series are also available in set. Please see P880.

Product	DC (mm)	DCON MS (mm)	LU (mm)	OAL (mm)
P8013.0X3.0	3.00	3.00	14.00	38.0
P8016.3X3.0	6.30	3.00	12.70	45.0
P8016.0X6.0	6.00	6.00	18.00	50.0
P8018.0X6.0	8.00	6.00	19.00	64.0
P8019.6X6.0	9.60	6.00	19.00	64.0
P80112.7X6.0	12.70	6.00	25.00	70.0
P80116.0X6.0	16.00	6.00	25.00	70.0

P801C



Rotary Burr - Cylinder without endcut, Shape A, TiAlN Coating

DC double cut flute style with close spaced edges for trimming and deburring surfaces. Carbide design for cutting diameter up to 6 mm; above 6 mm carbide head with toughened and hardened steel shank. TiAlN coating for increased tool life, reduced friction and improved swarf evacuation.

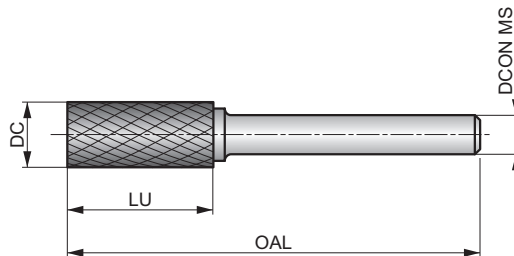

HM	A	TiAlN
DC	DORMER	



Workpiece material group suitability. Recommended operating speed (RPM) on page 267.

P1.1	P1.2	P1.3	P2.1	P2.2	P2.3	P3.1	P3.2	P3.3	P4.1	P4.2	P4.3	M1.1	M1.2
M2.1	M2.2	M2.3	M3.1	M3.2	M3.3	M4.1	M4.2	K1.1	K1.2	K1.3	K2.1	K2.2	K2.3
K3.1	K3.2	K3.3	K4.1	K4.2	K4.3	K4.4	K4.5	K5.1	K5.2	K5.3	N3.1	N3.2	N3.3
S1.1	S1.2	S1.3	S2.1	S2.2	S3.1	S3.2	S4.1	S4.2	H1.1	H2.1	H2.2	H3.1	H3.2
H4.1	H4.2												

DC≤6.00 mm: DCON MS tolerance h6; DC>6.00 mm: Brazed on steel shank with DCON MS tolerance h7.

Product	DC (mm)	DCON MS (mm)	LU (mm)	OAL (mm)
P801C3.0X3.0	3.00	3.00	14.00	38.0
P801C6.0X6.0	6.00	6.00	18.00	50.0
P801C8.0X6.0	8.00	6.00	19.00	64.0
P801C9.6X6.0	9.60	6.00	19.00	64.0
P801C12.7X6.0	12.70	6.00	25.00	70.0

P803



Rotary Burr - Cylinder with endcut, Shape B, Bright Finish

DC double cut flute style with close spaced edges for trimming and deburring surfaces and right-angled corners. Carbide design for cutting diameter up to 6 mm; above 6 mm carbide head with toughened and hardened steel shank.

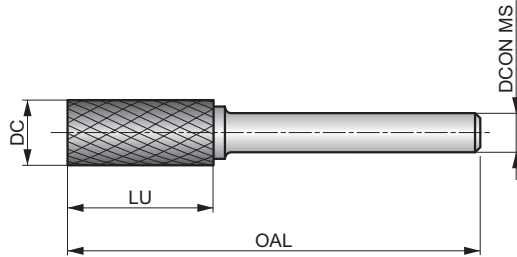

HM	B	
Bright	DC	



Workpiece material group suitability. Recommended operating speed (RPM) on page 267.

P1.1	P1.2	P1.3	P2.1	P2.2	P2.3	P3.1	P3.2	P3.3	P4.1	P4.2	P4.3	M1.1	M1.2
M2.1	M2.2	M2.3	M3.1	M3.2	M3.3	M4.1	M4.2	K1.1	K1.2	K1.3	K2.1	K2.2	K2.3
K3.1	K3.2	K3.3	K4.1	K4.2	K4.3	K4.4	K4.5	K5.1	K5.2	K5.3	N3.1	N3.2	N3.3
S1.1	S1.2	S1.3	S2.1	S2.2	S3.1	S3.2	S4.1	S4.2	H1.1	H2.1	H2.2	H3.1	H3.2
H4.1	H4.2												

DC ≤ 6.00 mm: DCON MS tolerance h6; DC > 6.00 mm: Brazed on steel shank with DCON MS tolerance h7.
 Products from this series are also available in set. Please see P880 or P890.

Product	DC	DCON MS	LU	OAL
	(mm)	(mm)	(mm)	(mm)
P8033.0X3.0	3.00	3.00	14.00	38.0
P8036.3X3.0	6.30	3.00	12.70	45.0
P8036.0X6.0	6.00	6.00	18.00	50.0
P8038.0X6.0	8.00	6.00	19.00	64.0
P8039.6X6.0	9.60	6.00	19.00	64.0
P80312.7X6.0	12.70	6.00	25.00	70.0
P80316.0X6.0	16.00	6.00	25.00	70.0

P803C



Rotary Burr - Cylinder with endcut, Shape B, TiAlN Coating

DC double cut flute style with close spaced edges for trimming and deburring surfaces and right-angled corners. Carbide design for cutting diameter up to 6 mm; above 6 mm carbide head with toughened and hardened steel shank. TiAlN coating for increased tool life, reduced friction and improved swarf evacuation.

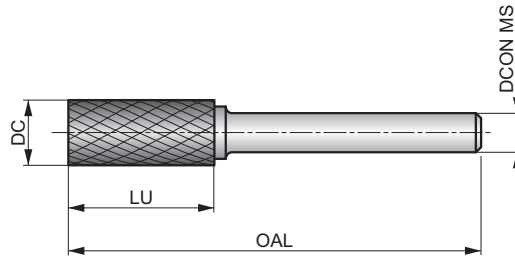

Workpiece material group suitability. Recommended operating speed (RPM) on page 267.

P1.1	P1.2	P1.3	P2.1	P2.2	P2.3	P3.1	P3.2	P3.3	P4.1	P4.2	P4.3	M1.1	M1.2
M2.1	M2.2	M2.3	M3.1	M3.2	M3.3	M4.1	M4.2	K1.1	K1.2	K1.3	K2.1	K2.2	K2.3
K3.1	K3.2	K3.3	K4.1	K4.2	K4.3	K4.4	K4.5	K5.1	K5.2	K5.3	N3.1	N3.2	N3.3
S1.1	S1.2	S1.3	S2.1	S2.2	S3.1	S3.2	S4.1	S4.2	H1.1	H2.1	H2.2	H3.1	H3.2
H4.1	H4.2												

DC≤6.00 mm: DCON MS tolerance h6; DC>6.00 mm: Brazed on steel shank with DCON MS tolerance h7.
 Products from this series are also available in set. Please see P880.

Product	DC (mm)	DCON MS (mm)	LU (mm)	OAL (mm)
P803C3.0X3.0	3.00	3.00	14.00	38.0
P803C6.0X6.0	6.00	6.00	18.00	50.0
P803C8.0X6.0	8.00	6.00	19.00	64.0
P803C9.6X6.0	9.60	6.00	19.00	64.0
P803C12.7X6.0	12.70	6.00	25.00	70.0

P805



Rotary Burr - Ball Nosed Cylinder, Shape C, Bright Finish

DC double cut flute style with close spaced edges for trimming and deburring contours and circular arcs. Carbide design for cutting diameter up to 6 mm; above 6 mm carbide head with toughened and hardened steel shank.

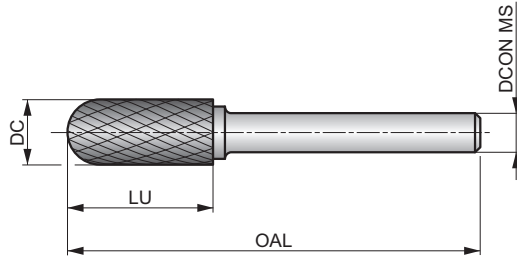

HM	C	Bright
DC		



Workpiece material group suitability. Recommended operating speed (RPM) on page 267.

P1.1	P1.2	P1.3	P2.1	P2.2	P2.3	P3.1	P3.2	P3.3	P4.1	P4.2	P4.3	M1.1	M1.2
M2.1	M2.2	M2.3	M3.1	M3.2	M3.3	M4.1	M4.2	K1.1	K1.2	K1.3	K2.1	K2.2	K2.3
K3.1	K3.2	K3.3	K4.1	K4.2	K4.3	K4.4	K4.5	K5.1	K5.2	K5.3	N3.1	N3.2	N3.3
S1.1	S1.2	S1.3	S2.1	S2.2	S3.1	S3.2	S4.1	S4.2	H1.1	H2.1	H2.2	H3.1	H3.2
H4.1	H4.2												

DC ≤ 6.00 mm: DCON MS tolerance h6; DC > 6.00 mm: Brazed on steel shank with DCON MS tolerance h7.
 Products from this series are also available in set. Please see P880 or P890.

Product	DC (mm)	DCON MS (mm)	LU (mm)	OAL (mm)
P8053.0X3.0	3.00	3.00	14.00	38.0
P8056.3X3.0	6.30	3.00	12.70	45.0
P8056.0X6.0	6.00	6.00	18.00	50.0
P8058.0X6.0	8.00	6.00	19.00	64.0
P8059.6X6.0	9.60	6.00	19.00	64.0
P80512.7X6.0	12.70	6.00	25.00	70.0
P80516.0X6.0	16.00	6.00	25.00	70.0

P805C



Rotary Burr - Ball Nosed Cylinder, Shape C, TiAlN Coating

DC double cut flute style with close spaced edges for trimming and deburring contours and circular arcs. Carbide design for cutting diameter up to 6 mm; above 6 mm carbide head with toughened and hardened steel shank. TiAlN coating for increased tool life, reduced friction and improved swarf evacuation.

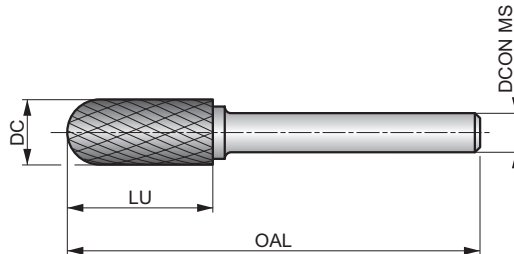

HM	C	TiAlN
DC	DORMER	



Workpiece material group suitability. Recommended operating speed (RPM) on page 267.

P1.1	P1.2	P1.3	P2.1	P2.2	P2.3	P3.1	P3.2	P3.3	P4.1	P4.2	P4.3	M1.1	M1.2
M2.1	M2.2	M2.3	M3.1	M3.2	M3.3	M4.1	M4.2	K1.1	K1.2	K1.3	K2.1	K2.2	K2.3
K3.1	K3.2	K3.3	K4.1	K4.2	K4.3	K4.4	K4.5	K5.1	K5.2	K5.3	N3.1	N3.2	N3.3
S1.1	S1.2	S1.3	S2.1	S2.2	S3.1	S3.2	S4.1	S4.2	H1.1	H2.1	H2.2	H3.1	H3.2
H4.1	H4.2												

DC≤6.00 mm: DCON MS tolerance h6; DC>6.00 mm: Brazed on steel shank with DCON MS tolerance h7.
 Products from this series are also available in set. Please see P880 or P890.

Product	DC (mm)	DCON MS (mm)	LU (mm)	OAL (mm)
P805C3.0X3.0	3.00	3.00	14.00	38.0
P805C6.0X6.0	6.00	6.00	18.00	50.0
P805C8.0X6.0	8.00	6.00	19.00	64.0
P805C9.6X6.0	9.60	6.00	19.00	64.0
P805C12.7X6.0	12.70	6.00	25.00	70.0

P807



Rotary Burr - Ball, Shape D, Bright Finish

DC double cut flute style with close spaced edges for intricate carving, metal engraving and welding preparation. Carbide design for cutting diameter up to 6 mm; above 6 mm carbide head with toughened and hardened steel shank.

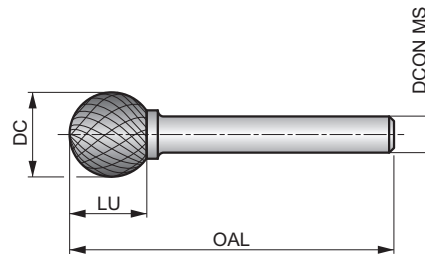

HM	Bright
DC	



Workpiece material group suitability. Recommended operating speed (RPM) on page 267.

P1.1	P1.2	P1.3	P2.1	P2.2	P2.3	P3.1	P3.2	P3.3	P4.1	P4.2	P4.3	M1.1	M1.2
M2.1	M2.2	M2.3	M3.1	M3.2	M3.3	M4.1	M4.2	K1.1	K1.2	K1.3	K2.1	K2.2	K2.3
K3.1	K3.2	K3.3	K4.1	K4.2	K4.3	K4.4	K4.5	K5.1	K5.2	K5.3	N3.1	N3.2	N3.3
S1.1	S1.2	S1.3	S2.1	S2.2	S3.1	S3.2	S4.1	S4.2	H1.1	H2.1	H2.2	H3.1	H3.2
H4.1	H4.2												

DC ≤ 6.00 mm: DCON MS tolerance h6; DC > 6.00 mm: Brazed on steel shank with DCON MS tolerance h7.
 Products from this series are also available in set. Please see P880.

Product	DC (mm)	DCON MS (mm)	LU (mm)	OAL (mm)
P8073.0X3.0	3.00	3.00	2.50	38.0
P8074.0X3.0	4.00	3.00	3.40	38.0
P8076.3X3.0	6.30	3.00	5.00	38.0
P8076.0X6.0	6.00	6.00	4.70	50.0
P8078.0X6.0	8.00	6.00	6.00	52.0
P8079.6X6.0	9.60	6.00	8.00	54.0
P80712.7X6.0	12.70	6.00	11.00	56.0
P80716.0X6.0	16.00	6.00	14.00	59.0

P807C



Rotary Burr - Ball, Shape D, TiAlN Coating

DC double cut flute style with close spaced edges for intricate carving, metal engraving and welding preparation. Carbide design for cutting diameter up to 6 mm; above 6 mm carbide head with toughened and hardened steel shank. TiAlN coating for increased tool life, reduced friction and improved swarf evacuation.

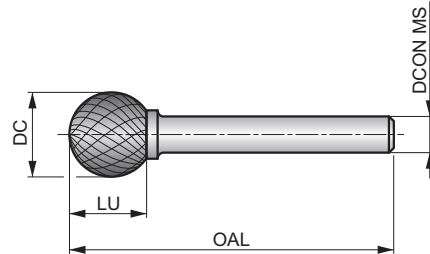

HM		
DC		



Workpiece material group suitability. Recommended operating speed (RPM) on page 267.

P1.1	P1.2	P1.3	P2.1	P2.2	P2.3	P3.1	P3.2	P3.3	P4.1	P4.2	P4.3	M1.1	M1.2
M2.1	M2.2	M2.3	M3.1	M3.2	M3.3	M4.1	M4.2	K1.1	K1.2	K1.3	K2.1	K2.2	K2.3
K3.1	K3.2	K3.3	K4.1	K4.2	K4.3	K4.4	K4.5	K5.1	K5.2	K5.3	N3.1	N3.2	N3.3
S1.1	S1.2	S1.3	S2.1	S2.2	S3.1	S3.2	S4.1	S4.2	H1.1	H2.1	H2.2	H3.1	H3.2
H4.1	H4.2												

DC≤6.00 mm: DCON MS tolerance h6; DC>6.00 mm: Brazed on steel shank with DCON MS tolerance h7.
 Products from this series are also available in set. Please see P880.

Product	DC (mm)	DCON MS (mm)	LU (mm)	OAL (mm)
P807C3.0X3.0	3.00	3.00	2.50	38.0
P807C6.0X6.0	6.00	6.00	4.70	50.0
P807C8.0X6.0	8.00	6.00	6.00	52.0
P807C9.6X6.0	9.60	6.00	8.00	54.0
P807C12.7X6.0	12.70	6.00	11.00	56.0

P809



Rotary Burr - Oval, Shape E

DC double cut flute style with close spaced edges for round edge contouring. Carbide design for cutting diameter up to 6 mm; above 6 mm carbide head with toughend and hardened steel shank.

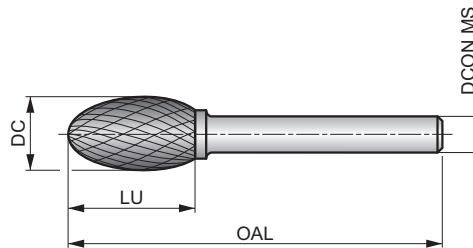

HM	E	Bright
DC		



Workpiece material group suitability. Recommended operating speed (RPM) on page 267.

P1.1	P1.2	P1.3	P2.1	P2.2	P2.3	P3.1	P3.2	P3.3	P4.1	P4.2	P4.3	M1.1	M1.2
M2.1	M2.2	M2.3	M3.1	M3.2	M3.3	M4.1	M4.2	K1.1	K1.2	K1.3	K2.1	K2.2	K2.3
K3.1	K3.2	K3.3	K4.1	K4.2	K4.3	K4.4	K4.5	K5.1	K5.2	K5.3	N3.1	N3.2	N3.3
S1.1	S1.2	S1.3	S2.1	S2.2	S3.1	S3.2	S4.1	S4.2	H1.1	H2.1	H2.2	H3.1	H3.2
H4.1	H4.2												

DC≤6.00 mm: DCON MS tolerance h6; DC>6.00 mm: Brazed on steel shank with DCON MS tolerance h7.
Products from this series are also available in set. Please see P880.

Product	DC (mm)	DCON MS (mm)	LU (mm)	OAL (mm)
P8093.0X3.0	3.00	3.00	6.00	38.0
P8096.3X3.0	6.30	3.00	9.50	42.0
P8096.0X6.0	6.00	6.00	10.00	50.0
P8098.0X6.0	8.00	6.00	15.00	60.0
P8099.6X6.0	9.60	6.00	16.00	60.0
P80912.7X6.0	12.70	6.00	22.00	67.0
P80916.0X6.0	16.00	6.00	25.00	70.0

P811



Rotary Burr - Ball Nosed Tree, Shape F, Bright Finish

DC double cut flute style with close spaced edges for multi-angle contouring, rounding of edges and cutting into hard to reach areas. Carbide design for cutting diameter up to 6 mm; above 6 mm carbide head with toughened and hardened steel shank.

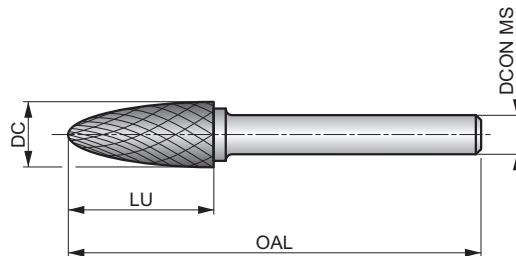

HM	F	Bright
DC	DORMER	



Workpiece material group suitability. Recommended operating speed (RPM) on page 267.

P1.1	P1.2	P1.3	P2.1	P2.2	P2.3	P3.1	P3.2	P3.3	P4.1	P4.2	P4.3	M1.1	M1.2
M2.1	M2.2	M2.3	M3.1	M3.2	M3.3	M4.1	M4.2	K1.1	K1.2	K1.3	K2.1	K2.2	K2.3
K3.1	K3.2	K3.3	K4.1	K4.2	K4.3	K4.4	K4.5	K5.1	K5.2	K5.3	N3.1	N3.2	N3.3
S1.1	S1.2	S1.3	S2.1	S2.2	S3.1	S3.2	S4.1	S4.2	H1.1	H2.1	H2.2	H3.1	H3.2
H4.1	H4.2												

DC≤6.00 mm: DCON MS tolerance h6; DC>6.00 mm: Brazed on steel shank with DCON MS tolerance h7.
 Products from this series are also available in set. Please see P880 or P890.

Product	DC (mm)	DCON MS (mm)	LU (mm)	OAL (mm)
P8113.0X3.0	3.00	3.00	14.00	38.0
P8116.3X3.0	6.30	3.00	12.70	45.0
P8116.0X6.0	6.00	6.00	18.00	50.0
P8118.0X6.0	8.00	6.00	20.00	65.0
P8119.6X6.0	9.60	6.00	19.00	64.0
P81112.7X6.0	12.70	6.00	25.00	70.0
P81116.0X6.0	16.00	6.00	25.00	70.0

P811C



Rotary Burr - Ball Nosed Tree, Shape F, TiAlN Coating

DC double cut flute style with close spaced edges for multi-angle contouring, rounding of edges and cutting into hard to reach areas. Carbide design for cutting diameter up to 6 mm; above 6 mm carbide head with tough hard steel shank. TiAlN coating for increased tool life, reduced friction and improved swarf evacuation.

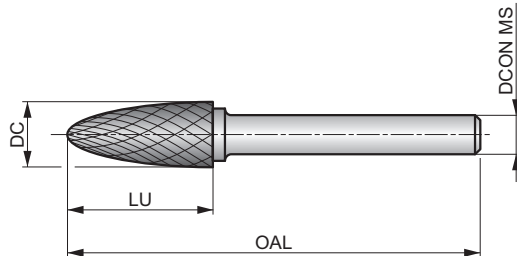

HM	F	TiAlN
DC	DORMER	



Workpiece material group suitability. Recommended operating speed (RPM) on page 267.

P1.1	P1.2	P1.3	P2.1	P2.2	P2.3	P3.1	P3.2	P3.3	P4.1	P4.2	P4.3	M1.1	M1.2
M2.1	M2.2	M2.3	M3.1	M3.2	M3.3	M4.1	M4.2	K1.1	K1.2	K1.3	K2.1	K2.2	K2.3
K3.1	K3.2	K3.3	K4.1	K4.2	K4.3	K4.4	K4.5	K5.1	K5.2	K5.3	N3.1	N3.2	N3.3
S1.1	S1.2	S1.3	S2.1	S2.2	S3.1	S3.2	S4.1	S4.2	H1.1	H2.1	H2.2	H3.1	H3.2
H4.1	H4.2												

DC ≤ 6.00 mm: DCON MS tolerance h6; DC > 6.00 mm: Brazed on steel shank with DCON MS tolerance h7.
 Products from this series are also available in set. Please see P880.

Product	DC (mm)	DCON MS (mm)	LU (mm)	OAL (mm)
P811C3.0X3.0	3.00	3.00	14.00	38.0
P811C6.0X6.0	6.00	6.00	18.00	50.0
P811C9.6X6.0	9.60	6.00	19.00	64.0
P811C12.7X6.0	12.70	6.00	25.00	70.0

P813



Rotary Burr - Pointed Tree, Shape G, Bright Finish

DC double cut flute style with close spaced edges for multi-angle contouring and cutting narrow angles in hard to reach areas. Carbide design for cutting diameter up to 6 mm; above 6 mm carbide head with toughened and hardened steel shank.

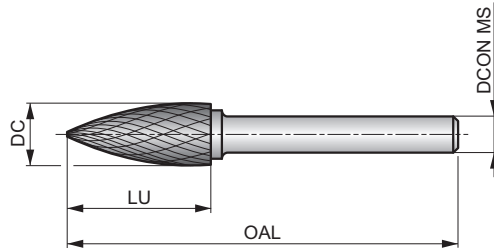

HM	G	Bright
DC		



Workpiece material group suitability. Recommended operating speed (RPM) on page 267.

P1.1	P1.2	P1.3	P2.1	P2.2	P2.3	P3.1	P3.2	P3.3	P4.1	P4.2	P4.3	M1.1	M1.2
M2.1	M2.2	M2.3	M3.1	M3.2	M3.3	M4.1	M4.2	K1.1	K1.2	K1.3	K2.1	K2.2	K2.3
K3.1	K3.2	K3.3	K4.1	K4.2	K4.3	K4.4	K4.5	K5.1	K5.2	K5.3	N3.1	N3.2	N3.3
S1.1	S1.2	S1.3	S2.1	S2.2	S3.1	S3.2	S4.1	S4.2	H1.1	H2.1	H2.2	H3.1	H3.2
H4.1	H4.2												

DC≤6.00 mm: DCON MS tolerance h6; DC>6.00 mm: Brazed on steel shank with DCON MS tolerance h7.
Products from this series are also available in set. Please see P880 or P890.

Product	DC (mm)	DCON MS (mm)	LU (mm)	OAL (mm)
P8133.0X3.0	3.00	3.00	14.00	38.0
P8136.3X3.0	6.30	3.00	12.70	45.0
P8136.0X6.0	6.00	6.00	18.00	50.0
P8138.0X6.0	8.00	6.00	19.00	64.0
P8139.6X6.0	9.60	6.00	19.00	64.0
P81312.7X6.0	12.70	6.00	25.00	70.0
P81316.0X6.0	16.00	6.00	25.00	70.0

P813C



Rotary Burr - Pointed Tree, Shape G, TiAlN Coating

DC double cut flute style with close spaced edges for multi-angle contouring and cutting narrow angles in hard to reach areas. Carbide design for cutting diameter up to 6 mm; above 6 mm carbide head with tough hard steel shank. TiAlN coating for increased tool life, reduced friction and improved swarf evacuation.

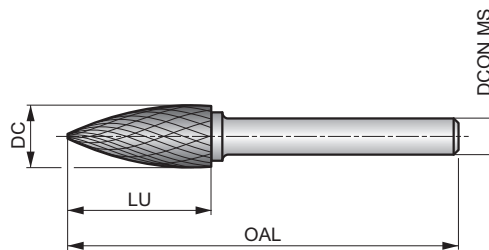

HM	G	TiAlN
DC	DORMER	



Workpiece material group suitability. Recommended operating speed (RPM) on page 267.

P1.1	P1.2	P1.3	P2.1	P2.2	P2.3	P3.1	P3.2	P3.3	P4.1	P4.2	P4.3	M1.1	M1.2
M2.1	M2.2	M2.3	M3.1	M3.2	M3.3	M4.1	M4.2	K1.1	K1.2	K1.3	K2.1	K2.2	K2.3
K3.1	K3.2	K3.3	K4.1	K4.2	K4.3	K4.4	K4.5	K5.1	K5.2	K5.3	N3.1	N3.2	N3.3
S1.1	S1.2	S1.3	S2.1	S2.2	S3.1	S3.2	S4.1	S4.2	H1.1	H2.1	H2.2	H3.1	H3.2
H4.1	H4.2												

DC≤6.00 mm: DCON MS tolerance h6; DC>6.00 mm: Brazed on steel shank with DCON MS tolerance h7.
Products from this series are also available in set. Please see P880.

Product	DC (mm)	DCON MS (mm)	LU (mm)	OAL (mm)
P813C3.0X3.0	3.00	3.00	14.00	38.0
P813C6.0X6.0	6.00	6.00	18.00	50.0
P813C9.6X6.0	9.60	6.00	19.00	64.0
P813C12.7X6.0	12.70	6.00	25.00	70.0

P815



Rotary Burr - Flame, Shape H, Bright Finish

DC double cut flute style with close spaced edges for round edge contouring and welding preparation. Carbide design for cutting diameter up to 6 mm; above 6 mm carbide head with toughened and hardened steel shank.

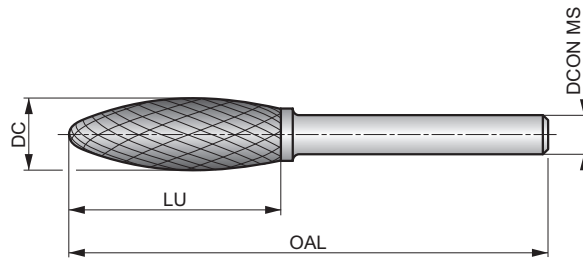

HM	H	Bright
DC	DORMER	



Workpiece material group suitability. Recommended operating speed (RPM) on page 267.

P1.1	P1.2	P1.3	P2.1	P2.2	P2.3	P3.1	P3.2	P3.3	P4.1	P4.2	P4.3	M1.1	M1.2
M2.1	M2.2	M2.3	M3.1	M3.2	M3.3	M4.1	M4.2	K1.1	K1.2	K1.3	K2.1	K2.2	K2.3
K3.1	K3.2	K3.3	K4.1	K4.2	K4.3	K4.4	K4.5	K5.1	K5.2	K5.3	N3.1	N3.2	N3.3
S1.1	S1.2	S1.3	S2.1	S2.2	S3.1	S3.2	S4.1	S4.2	H1.1	H2.1	H2.2	H3.1	H3.2
H4.1	H4.2												

DC≤6.00 mm: DCON MS tolerance h6; DC>6.00 mm: Brazed on steel shank with DCON MS tolerance h7.
 Products from this series are also available in set. Please see P880.

Product	DC (mm)	DCON MS (mm)	LU (mm)	OAL (mm)
P8153.0X3.0	3.00	3.00	6.00	38.0
P8156.0X6.0	6.00	6.00	14.00	50.0
P8158.0X6.0	8.00	6.00	19.00	64.0
P8159.6X6.0	9.60	6.00	19.00	65.0
P81512.7X6.0	12.70	6.00	32.00	77.0
P81516.0X6.0	16.00	6.00	36.00	81.0

P815C



Rotary Burr - Flame, Shape H, TiAlN Coating

DC double cut flute style with close spaced edges for round edge contouring and welding preparation. Carbide head with toughened and hardened steel shank. TiAlN coating for increased tool life, reduced friction and improved swarf evacuation.

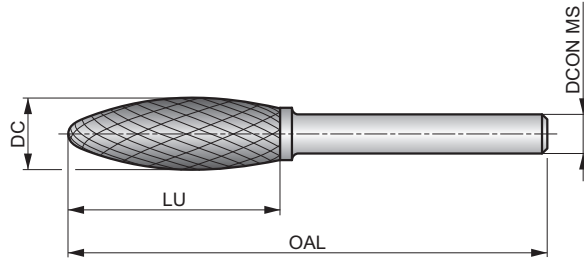

HM	H	TiAlN
DC	DORMER	



Workpiece material group suitability. Recommended operating speed (RPM) on page 267.

P1.1	P1.2	P1.3	P2.1	P2.2	P2.3	P3.1	P3.2	P3.3	P4.1	P4.2	P4.3	M1.1	M1.2
M2.1	M2.2	M2.3	M3.1	M3.2	M3.3	M4.1	M4.2	K1.1	K1.2	K1.3	K2.1	K2.2	K2.3
K3.1	K3.2	K3.3	K4.1	K4.2	K4.3	K4.4	K4.5	K5.1	K5.2	K5.3	N3.1	N3.2	N3.3
S1.1	S1.2	S1.3	S2.1	S2.2	S3.1	S3.2	S4.1	S4.2	H1.1	H2.1	H2.2	H3.1	H3.2
H4.1	H4.2												

Brazed on Steel Shank with DCON MS tolerance h7.

Product	DC (mm)	DCON MS (mm)	LU (mm)	OAL (mm)
P815C8.0X6.0	8.00	6.00	19.00	64.0
P815C12.7X6.0	12.70	6.00	32.00	77.0

P821



Rotary Burr - Ball Nosed Cone, Shape L, Bright Finish

DC double cut flute style with close spaced edges for enlarging holes, rounding edges and surface finishing in tight narrow angles or other hard to reach areas. Carbide design for cutting diameter up to 6 mm; above 6 mm carbide head with toughened and hardened steel shank.

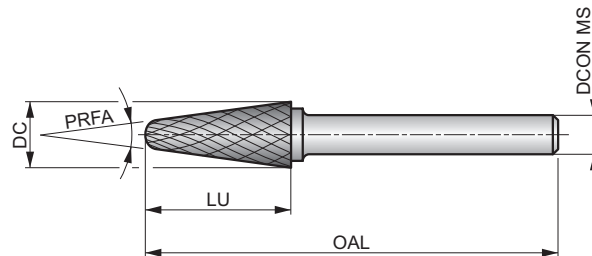

HM		
DC		



Workpiece material group suitability. Recommended operating speed (RPM) on page 267.

P1.1	P1.2	P1.3	P2.1	P2.2	P2.3	P3.1	P3.2	P3.3	P4.1	P4.2	P4.3	M1.1	M1.2
M2.1	M2.2	M2.3	M3.1	M3.2	M3.3	M4.1	M4.2	K1.1	K1.2	K1.3	K2.1	K2.2	K2.3
K3.1	K3.2	K3.3	K4.1	K4.2	K4.3	K4.4	K4.5	K5.1	K5.2	K5.3	N3.1	N3.2	N3.3
S1.1	S1.2	S1.3	S2.1	S2.2	S3.1	S3.2	S4.1	S4.2	H1.1	H2.1	H2.2	H3.1	H3.2
H4.1	H4.2												

DC≤6.00 mm: DCON MS tolerance h6; DC>6.00 mm: Brazed on steel shank with DCON MS tolerance h7.
 Products from this series are also available in set. Please see P880 or P890.

Product	DC (mm)	DCON MS (mm)	LU (mm)	OAL (mm)	PRFA (°)
P8213.0X3.0	3.00	3.00	14.00	38.0	8
P8216.0X6.0	6.00	6.00	18.00	50.0	14
P8218.0X6.0	8.00	6.00	25.40	70.0	14
P8219.6X6.0	9.60	6.00	30.00	76.0	14
P82112.7X6.0	12.70	6.00	32.00	77.0	14
P82116.0X6.0	16.00	6.00	33.00	78.0	14

P821C



Rotary Burr - Ball Nosed Cone, Shape L, TiAlN Coating

DC double cut flute style with close spaced edges for enlarging holes, rounding edges and surface finishing in tight narrow angles or other hard to reach areas. Carbide design for cutting diameter up to 6 mm; above 6 mm carbide head with toughened and hardened steel shank. TiAlN coating for increased tool life.

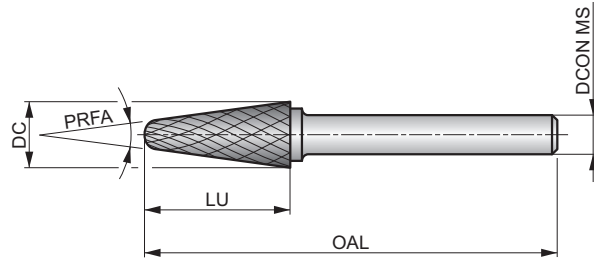

HM	L	TiAlN
DC	DORMER	



Workpiece material group suitability. Recommended operating speed (RPM) on page 267.

P1.1	P1.2	P1.3	P2.1	P2.2	P2.3	P3.1	P3.2	P3.3	P4.1	P4.2	P4.3	M1.1	M1.2
M2.1	M2.2	M2.3	M3.1	M3.2	M3.3	M4.1	M4.2	K1.1	K1.2	K1.3	K2.1	K2.2	K2.3
K3.1	K3.2	K3.3	K4.1	K4.2	K4.3	K4.4	K4.5	K5.1	K5.2	K5.3	N3.1	N3.2	N3.3
S1.1	S1.2	S1.3	S2.1	S2.2	S3.1	S3.2	S4.1	S4.2	H1.1	H2.1	H2.2	H3.1	H3.2
H4.1	H4.2												

DC ≤ 6.00 mm: DCON MS tolerance h6; DC > 6.00 mm: Brazed on steel shank with DCON MS tolerance h7.

Product	DC (mm)	DCON MS (mm)	LU (mm)	OAL (mm)	PRFA (°)
P821C3.0X3.0	3.00	3.00	14.00	38.0	8
P821C12.7X6.0	12.70	6.00	32.00	77.0	14

P823



Rotary Burr - Cone, Shape M

DC double cut flute style with close spaced edges for enlarging holes, surface finishing and cutting narrow angles in hard to reach areas. Carbide design for cutting diameter up to 6 mm; above 6 mm carbide head with toughened and hardened steel shank.

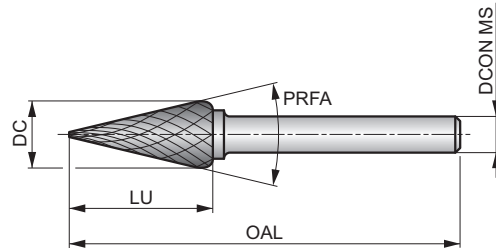

HM	M	Bright
DC	DORMER	



Workpiece material group suitability. Recommended operating speed (RPM) on page 267.

P1.1	P1.2	P1.3	P2.1	P2.2	P2.3	P3.1	P3.2	P3.3	P4.1	P4.2	P4.3	M1.1	M1.2
M2.1	M2.2	M2.3	M3.1	M3.2	M3.3	M4.1	M4.2	K1.1	K1.2	K1.3	K2.1	K2.2	K2.3
K3.1	K3.2	K3.3	K4.1	K4.2	K4.3	K4.4	K4.5	K5.1	K5.2	K5.3	N3.1	N3.2	N3.3
S1.1	S1.2	S1.3	S2.1	S2.2	S3.1	S3.2	S4.1	S4.2	H1.1	H2.1	H2.2	H3.1	H3.2
H4.1	H4.2												

DC≤6.00 mm: DCON MS tolerance h6; DC>6.00 mm: Brazed on steel shank with DCON MS tolerance h7.
Products from this series are also available in set. Please see P880.

Product	DC (mm)	DCON MS (mm)	LU (mm)	OAL (mm)	PRFA (°)
P8233.0X3.0	3.00	3.00	11.00	38.0	14
P8236.3X3.0	6.30	3.00	12.70	49.0	22
P8236.0X6.0	6.00	6.00	20.00	50.0	14
P8239.6X6.0	9.60	6.00	16.00	64.0	28
P82312.7X6.0	12.70	6.00	22.00	71.0	28
P82316.0X6.0	16.00	6.00	25.00	71.0	31

P817



Rotary Burr - 60° Countersink, Shape J

DC double cut flute style with close spaced edges for chamfering, making v-cuts and welding preparation. Carbide design for cutting diameter up to 6 mm; above 6 mm carbide head with toughened and hardened steel shank.

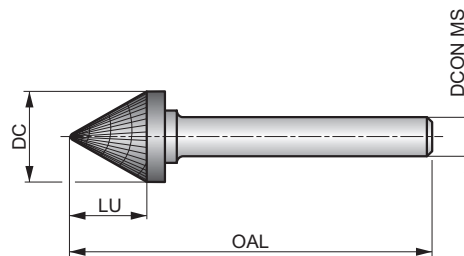

HM	J	Bright
60°	DC	DORMER



Workpiece material group suitability. Recommended operating speed (RPM) on page 267.

P1.1	P1.2	P1.3	P2.1	P2.2	P2.3	P3.1	P3.2	P3.3	P4.1	P4.2	P4.3	M1.1	M1.2
M2.1	M2.2	M2.3	M3.1	M3.2	M3.3	M4.1	M4.2	K1.1	K1.2	K1.3	K2.1	K2.2	K2.3
K3.1	K3.2	K3.3	K4.1	K4.2	K4.3	K4.4	K4.5	K5.1	K5.2	K5.3	N3.1	N3.2	N3.3
S1.1	S1.2	S1.3	S2.1	S2.2	S3.1	S3.2	S4.1	S4.2	H1.1	H2.1	H2.2	H3.1	H3.2
H4.1	H4.2												

DC≤6.00 mm: DCON MS tolerance h6; DC>6.00 mm: Brazed on steel shank with DCON MS tolerance h7.

Product	DC (mm)	DCON MS (mm)	LU (mm)	OAL (mm)
P8173.0X3.0	3.00	3.00	2.50	38.0
P8176.0X6.0	6.00	6.00	4.00	50.0
P8179.6X6.0	9.60	6.00	8.00	56.0
P81712.7X6.0	12.70	6.00	11.00	59.0
P81716.0X6.0	16.00	6.00	14.50	63.0

P819

Rotary Burr - 90° Countersink, Shape K

DC double cut flute style with close spaced edges for chamfering, making v-cuts and welding preparation. Carbide design for cutting diameter up to 6 mm; above 6 mm carbide head with toughened and hardened steel shank.

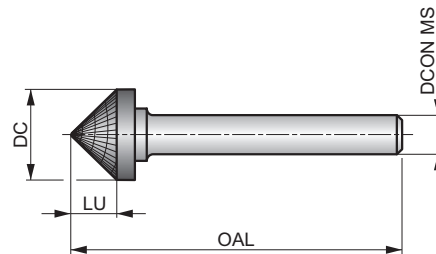

HM	K	Bright
90°	DC	DORMER



Workpiece material group suitability. Recommended operating speed (RPM) on page 267.

P1.1	P1.2	P1.3	P2.1	P2.2	P2.3	P3.1	P3.2	P3.3	P4.1	P4.2	P4.3	M1.1	M1.2
M2.1	M2.2	M2.3	M3.1	M3.2	M3.3	M4.1	M4.2	K1.1	K1.2	K1.3	K2.1	K2.2	K2.3
K3.1	K3.2	K3.3	K4.1	K4.2	K4.3	K4.4	K4.5	K5.1	K5.2	K5.3	N3.1	N3.2	N3.3
S1.1	S1.2	S1.3	S2.1	S2.2	S3.1	S3.2	S4.1	S4.2	H1.1	H2.1	H2.2	H3.1	H3.2
H4.1	H4.2												

DC≤6.00 mm: DCON MS tolerance h6; DC>6.00 mm: Brazed on steel shank with DCON MS tolerance h7.

Product	DC (mm)	DCON MS (mm)	LU (mm)	OAL (mm)
P8193.0X3.0	3.00	3.00	1.50	38.0
P8196.0X6.0	6.00	6.00	3.00	50.0
P8199.6X6.0	9.60	6.00	4.70	53.0
P81912.7X6.0	12.70	6.00	6.30	55.0
P81916.0X6.0	16.00	6.00	8.00	57.0

P825



Rotary Burr - Inverted Cone, Shape N

DC double cut flute style with close spaced edges for making inverted v-cuts and rear side chamfering. Carbide design for cutting diameter up to 6 mm; above 6 mm carbide head with toughened and hardened steel shank.

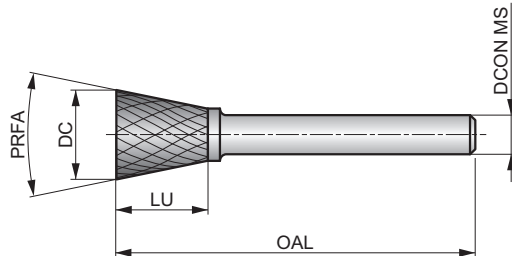

HM	N	Bright
DC		

Workpiece material group suitability. Recommended operating speed (RPM) on page 267.

P1.1	P1.2	P1.3	P2.1	P2.2	P2.3	P3.1	P3.2	P3.3	P4.1	P4.2	P4.3	M1.1	M1.2
M2.1	M2.2	M2.3	M3.1	M3.2	M3.3	M4.1	M4.2	K1.1	K1.2	K1.3	K2.1	K2.2	K2.3
K3.1	K3.2	K3.3	K4.1	K4.2	K4.3	K4.4	K4.5	K5.1	K5.2	K5.3	N3.1	N3.2	N3.3
S1.1	S1.2	S1.3	S2.1	S2.2	S3.1	S3.2	S4.1	S4.2	H1.1	H2.1	H2.2	H3.1	H3.2
H4.1	H4.2												

DC≤6.00 mm: DCON MS tolerance h6; DC>6.00 mm: Brazed on steel shank with DCON MS tolerance h7.

Product	DC (mm)	DCON MS (mm)	LU (mm)	OAL (mm)	PRFA (°)
P8253.0X3.0	3.00	3.00	4.00	38.0	10
P8256.3X3.0	6.30	3.00	6.00	39.0	12
P8256.0X6.0	6.00	6.00	8.00	50.0	10
P8259.6X6.0	9.60	6.00	9.50	55.0	16
P82512.7X6.0	12.70	6.00	12.70	58.0	28
P82516.0X6.0	16.00	6.00	19.00	64.0	18

P701



Rotary Burr - Cylinder without endcut, Shape A

ST single cut flute style with chipbreakers and medium spaced edge for trimming and deburring surfaces. Carbide design for cutting diameter equal to 6 mm; above 6 mm carbide head with toughened and hardened steel shank. First choice for steels.

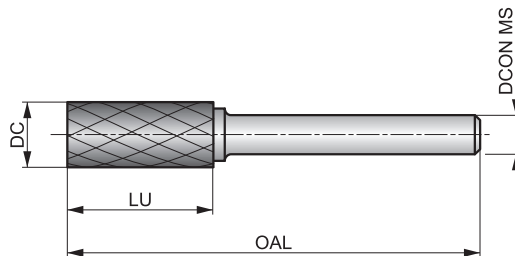

HM		
ST		

Workpiece material group suitability. Recommended operating speed (RPM) on page 267.

P1.1	P1.2	P1.3	P2.1	P2.2	P2.3	P3.1	P3.2	P3.3	P4.1	P4.2	P4.3
■	■	■	■	■	■	■	■	■	■	■	■

DC=6.00 mm: DCON MS tolerance h6; DC>6.00 mm: Brazed on steel shank with DCON MS tolerance h7.

Product	DC (mm)	DCON MS (mm)	LU (mm)	OAL (mm)
P7016.0X6.0	6.00	6.00	18.00	50.0
P7018.0X6.0	8.00	6.00	19.00	64.0
P7019.6X6.0	9.60	6.00	19.00	64.0
P70112.7X6.0	12.70	6.00	25.00	70.0

P703



Rotary Burr - Cylinder with endcut, Shape B

ST single cut flute style with chipbreakers and medium spaced edge for trimming and deburring surfaces and right-angled corners. Carbide design for cutting diameter equal to 6 mm; above 6 mm carbide head with toughened and hardened steel shank. First choice for steels.

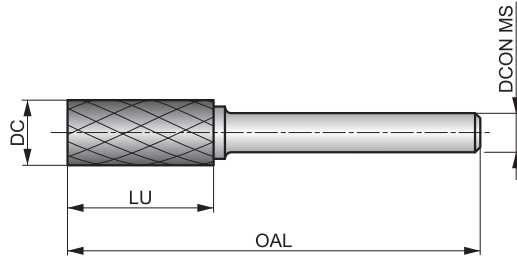

HM	B	
Bright	ST	



Workpiece material group suitability. Recommended operating speed (RPM) on page 267.

P1.1	P1.2	P1.3	P2.1	P2.2	P2.3	P3.1	P3.2	P3.3	P4.1	P4.2	P4.3
■	■	■	■	■	■	■	■	■	■	■	■

DC=6.00 mm: DCON MS tolerance h6; DC>6.00 mm: Brazed on steel shank with DCON MS tolerance h7.
 Products from this series are also available in set. Please see P880.

Product	DC	DCON MS	LU	OAL
	(mm)	(mm)	(mm)	(mm)
P7036.0X6.0	6.00	6.00	18.00	50.0
P7038.0X6.0	8.00	6.00	19.00	64.0
P7039.6X6.0	9.60	6.00	19.00	64.0
P70312.7X6.0	12.70	6.00	25.00	70.0

P705



Rotary Burr - Ball Nosed Cylinder, Shape C

ST single cut flute style with chipbreakers and medium spaced edge for trimming and deburring contours and circular arcs. Carbide design for cutting diameter equal to 6 mm; above 6 mm carbide head with toughened and hardened steel shank. First choice for steels.

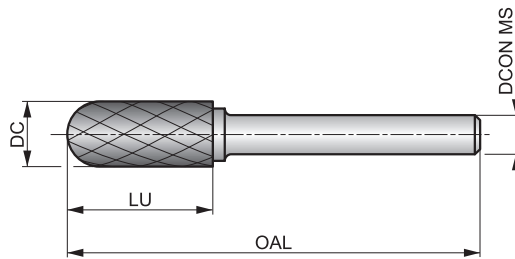

HM	C	Bright
ST	DORMER	



Workpiece material group suitability. Recommended operating speed (RPM) on page 267.

P1.1	P1.2	P1.3	P2.1	P2.2	P2.3	P3.1	P3.2	P3.3	P4.1	P4.2	P4.3
■	■	■	■	■	■	■	■	■	■	■	■

DC=6.00 mm: DCON MS tolerance h6; DC>6.00 mm: Brazed on steel shank with DCON MS tolerance h7.
 Products from this series are also available in set. Please see P880.

Product	DC (mm)	DCON MS (mm)	LU (mm)	OAL (mm)
P7056.0X6.0	6.00	6.00	18.00	50.0
P7058.0X6.0	8.00	6.00	19.00	64.0
P7059.6X6.0	9.60	6.00	19.00	64.0
P70512.7X6.0	12.70	6.00	25.00	70.0

P707



Rotary Burr - Ball, Shape D

ST single cut flute style with chipbreakers and medium spaced edge for intricate carving, metal engraving and welding preparation. Carbide design for cutting diameter equal to 6 mm; above 6 mm carbide head with toughened and hardened steel shank. First choice for steels.

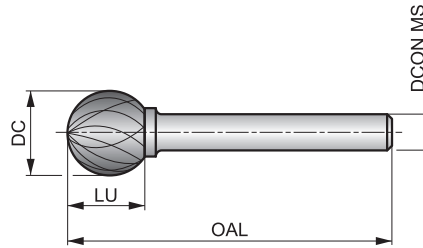

HM	D	Bright
ST	DORMER	



Workpiece material group suitability. Recommended operating speed (RPM) on page 267.

P1.1	P1.2	P1.3	P2.1	P2.2	P2.3	P3.1	P3.2	P3.3	P4.1	P4.2	P4.3
■	■	■	■	■	■	■	■	■	■	■	■

DC=6.00 mm: DCON MS tolerance h6; DC>6.00 mm: Brazed on steel shank with DCON MS tolerance h7.
 Products from this series are also available in set. Please see P880.

Product	DC	DCON MS	LU	OAL
	(mm)	(mm)	(mm)	(mm)
P7076.0X6.0	6.00	6.00	4.70	50.0
P7078.0X6.0	8.00	6.00	6.00	52.0
P7079.6X6.0	9.60	6.00	8.00	54.0
P70712.7X6.0	12.70	6.00	11.00	56.0

P709



Rotary Burr - Oval, Shape E

ST single cut flute style with chipbreakers and medium spaced edge for round edge contouring. Carbide head with toughened and hardened steel shank. First choice for steels.

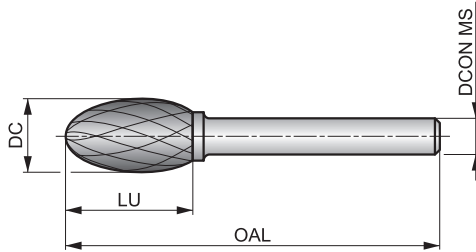

HM	E	Bright
ST	DORMER	



Workpiece material group suitability. Recommended operating speed (RPM) on page 267.

P1.1	P1.2	P1.3	P2.1	P2.2	P2.3	P3.1	P3.2	P3.3	P4.1	P4.2	P4.3
■	■	■	■	■	■	■	■	■	■	■	■

Brazed on Steel Shank with DCON MS tolerance h7.

Product	DC (mm)	DCON MS (mm)	LU (mm)	OAL (mm)
P70912.7X6.0	12.70	6.00	22.00	67.0

P711



Rotary Burr - Ball Nosed Tree, Shape F

ST single cut flute style with chipbreakers and medium spaced edge for multi-angle contouring, rounding of edges and cutting into hard to reach areas. Carbide design for cutting diameter equal to 6 mm; above 6 mm carbide head with toughend and hardened steel shank. First choice for steels.

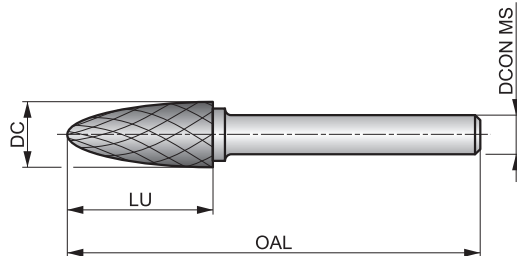

HM	F	Bright
ST	DORMER	



Workpiece material group suitability. Recommended operating speed (RPM) on page 267.

P1.1	P1.2	P1.3	P2.1	P2.2	P2.3	P3.1	P3.2	P3.3	P4.1	P4.2	P4.3
■	■	■	■	■	■	■	■	■	■	■	■

DC=6.00 mm: DCON MS tolerance h6; DC>6.00 mm: Brazed on steel shank with DCON MS tolerance h7.
 Products from this series are also available in set. Please see P880.

Product	DC (mm)	DCON MS (mm)	LU (mm)	OAL (mm)
P7116.0X6.0	6.00	6.00	18.00	50.0
P7118.0X6.0	8.00	6.00	20.00	65.0
P7119.6X6.0	9.60	6.00	19.00	64.0
P71112.7X6.0	12.70	6.00	25.00	70.0

P713



Rotary Burr - Pointed Tree, Shape G

ST single cut flute style with chipbreakers and medium spaced edge for multi-angle contouring and cutting narrow angles in hard to reach areas. Carbide design for cutting diameter equal to 6 mm; above 6 mm carbide head with toughened and hardened steel shank. First choice for steels.

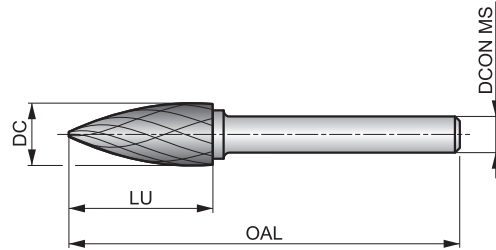

HM		
ST		



Workpiece material group suitability. Recommended operating speed (RPM) on page 267.

P1.1	P1.2	P1.3	P2.1	P2.2	P2.3	P3.1	P3.2	P3.3	P4.1	P4.2	P4.3
■	■	■	■	■	■	■	■	■	■	■	■

DC=6.00 mm: DCON MS tolerance h6; DC>6.00 mm: Brazed on steel shank with DCON MS tolerance h7.

Product	DC (mm)	DCON MS (mm)	LU (mm)	OAL (mm)
P7136.0X6.0	6.00	6.00	18.00	50.0
P7138.0X6.0	8.00	6.00	19.00	64.0
P7139.6X6.0	9.60	6.00	19.00	64.0
P71312.7X6.0	12.70	6.00	25.00	70.0

P715



Rotary Burr - Flame, Shape H

ST single cut flute style with chipbreakers and medium spaced edge for round edge contouring and welding preparation. Carbide head with toughened and hardened steel shank. First choice for steels.

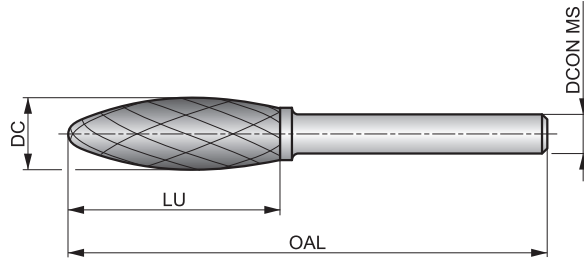

HM	H	Bright
ST	DORMER	



Workpiece material group suitability. Recommended operating speed (RPM) on page 267.

P1.1	P1.2	P1.3	P2.1	P2.2	P2.3	P3.1	P3.2	P3.3	P4.1	P4.2	P4.3
■	■	■	■	■	■	■	■	■	■	■	■

Brazed on Steel Shank with DCON MS tolerance h7.

Product	DC (mm)	DCON MS (mm)	LU (mm)	OAL (mm)
P7158.0X6.0	8.00	6.00	19.00	64.0
P71512.7X6.0	12.70	6.00	32.00	77.0

P721



Rotary Burr - Ball Nosed Cone, Shape L

ST single cut flute style with chipbreakers and medium spaced edge for enlarging holes, rounding edges and surface-finishing in tight narrow angles or other hard to reach areas. Carbide head with toughened and hardened steel shank. First choice for steels.

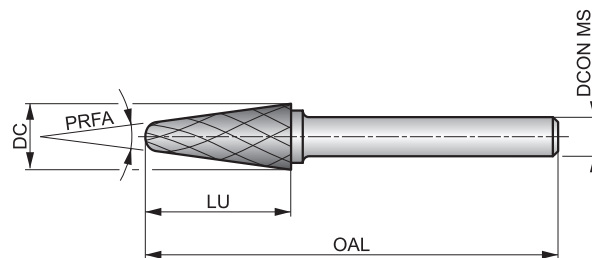

HM		Bright
ST		



Workpiece material group suitability. Recommended operating speed (RPM) on page 267.

P1.1	P1.2	P1.3	P2.1	P2.2	P2.3	P3.1	P3.2	P3.3	P4.1	P4.2	P4.3
■	■	■	■	■	■	■	■	■	■	■	■

Brazed on Steel Shank with DCON MS tolerance h7.
 Products from this series are also available in set. Please see P880.

Product	DC (mm)	DCON MS (mm)	LU (mm)	OAL (mm)	PRFA (°)
P72110.0X6.0	10.00	6.00	20.00	65.0	14
P7219.6X6.0	9.60	6.00	30.00	76.0	14
P72112.7X6.0	12.70	6.00	32.00	77.0	14

P601



Rotary Burr - Cylinder without endcut, Shape A

VA single cut flute style with medium spaced edges for trimming and deburring surfaces. Carbide design for cutting diameter up to 6 mm; above 6 mm carbide head with toughened and hardened steel shank. First choice for stainless steels.

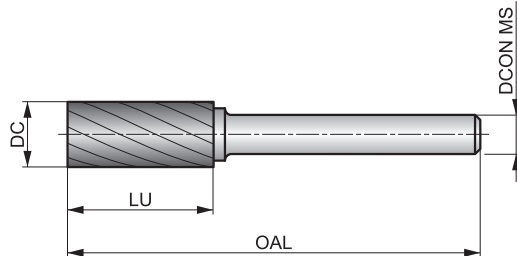

HM	A	Bright
VA	DORMER	



Workpiece material group suitability. Recommended operating speed (RPM) on page 267.

M1.1	M1.2	M2.1	M2.2	M2.3	M3.1	M3.2	M3.3	M4.1	M4.2	K4.1	K4.2
■	■	■	■	■	■	■	■	■	■	☑	☑

DC≤6.00 mm: DCON MS tolerance h6; DC>6.00 mm: Brazed on steel shank with DCON MS tolerance h7.
 Products from this series are also available in set. Please see P880.

Product	DC	DCON MS	LU	OAL
	(mm)	(mm)	(mm)	(mm)
P6013.0X3.0	3.00	3.00	14.00	38.0
P6016.3X3.0	6.30	3.00	12.70	45.0
P6016.0X6.0	6.00	6.00	18.00	50.0
P6018.0X6.0	8.00	6.00	19.00	64.0
P6019.6X6.0	9.60	6.00	19.00	64.0
P60112.7X6.0	12.70	6.00	25.00	70.0

P605

Rotary Burr - Ball Nosed Cylinder, Shape C

VA single cut flute style with medium spaced edges for trimming and deburring contours and circular arcs. Carbide design for cutting diameter up to 6 mm; above 6 mm carbide head with toughened and hardened steel shank. First choice for stainless steels.

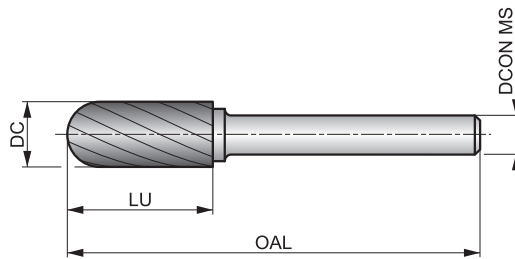

HM	C	Bright
VA	DORMER	



Workpiece material group suitability. Recommended operating speed (RPM) on page 267.

M1.1	M1.2	M2.1	M2.2	M2.3	M3.1	M3.2	M3.3	M4.1	M4.2	K4.1	K4.2
■	■	■	■	■	■	■	■	■	■	▣	▣

DC≤6.00 mm: DCON MS tolerance h6; DC>6.00 mm: Brazed on steel shank with DCON MS tolerance h7.
 Products from this series are also available in set. Please see P880.

Product	DC (mm)	DCON MS (mm)	LU (mm)	OAL (mm)
P6053.0X3.0	3.00	3.00	14.00	38.0
P6056.3X3.0	6.30	3.00	12.70	45.0
P6056.0X6.0	6.00	6.00	18.00	50.0
P6058.0X6.0	8.00	6.00	19.00	64.0
P6059.6X6.0	9.60	6.00	19.00	64.0
P60512.7X6.0	12.70	6.00	25.00	70.0

P607



Rotary Burr - Ball, Shape D

VA single cut flute style with medium spaced edges for intricate carving, metal engraving and welding preparation. Carbide design for cutting diameter up to 6 mm; above 6 mm carbide head with toughened and hardened steel shank. First choice for stainless steels.

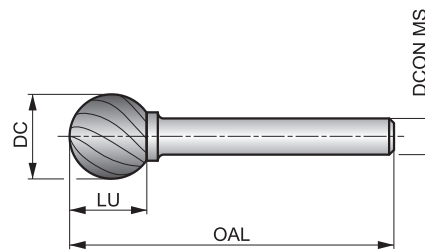

HM	D	Bright
VA		



Workpiece material group suitability. Recommended operating speed (RPM) on page 267.

M1.1	M1.2	M2.1	M2.2	M2.3	M3.1	M3.2	M3.3	M4.1	M4.2	K4.1	K4.2
■	■	■	■	■	■	■	■	■	■	☑	☑

DC≤6.00 mm: DCON MS tolerance h6; DC>6.00 mm: Brazed on steel shank with DCON MS tolerance h7.
 Products from this series are also available in set. Please see P880.

Product	DC	DCON MS	LU	OAL
	(mm)	(mm)	(mm)	(mm)
P6073.0X3.0	3.00	3.00	2.50	38.0
P6076.3X3.0	6.30	3.00	5.00	38.0
P6076.0X6.0	6.00	6.00	4.70	50.0
P6078.0X6.0	8.00	6.00	6.00	52.0
P6079.6X6.0	9.60	6.00	8.00	54.0
P60712.7X6.0	12.70	6.00	11.00	56.0

P609



Rotary Burr - Oval, Shape E

VA single cut flute style with medium spaced edges for round edge contouring. Carbide head with toughened and hardened steel shank. First choice for stainless steels.

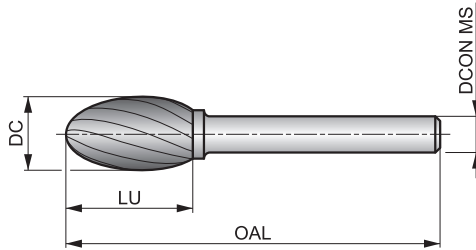

HM	E	Bright
VA	DORMER	



Workpiece material group suitability. Recommended operating speed (RPM) on page 267.

M1.1	M1.2	M2.1	M2.2	M2.3	M3.1	M3.2	M3.3	M4.1	M4.2	K4.1	K4.2
■	■	■	■	■	■	■	■	■	■	▣	▣

Brazed on Steel Shank with DCON MS tolerance h7.

Product	DC	DCON MS	LU	OAL
	(mm)	(mm)	(mm)	(mm)
P6098.0X6.0	8.00	6.00	15.00	60.0
P6099.6X6.0	9.60	6.00	16.00	60.0
P60912.7X6.0	12.70	6.00	22.00	67.0

P611



Rotary Burr - Ball Nosed Tree, Shape F

VA single cut flute style with medium spaced edges for multi-angle contouring, rounding of edges and cutting into hard to reach areas. Carbide design for cutting diameter up to 6 mm; above 6 mm carbide head with toughened and hardened steel shank. First choice for stainless steels.

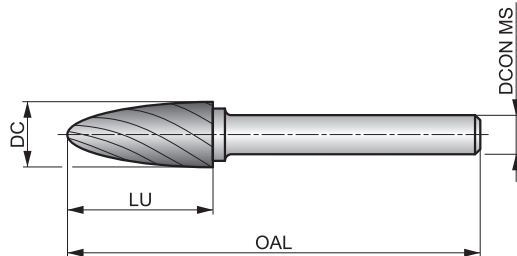

HM	F	Bright
VA	DORMER	



Workpiece material group suitability. Recommended operating speed (RPM) on page 267.

M1.1	M1.2	M2.1	M2.2	M2.3	M3.1	M3.2	M3.3	M4.1	M4.2	K4.1	K4.2
■	■	■	■	■	■	■	■	■	■	☑	☑

DC≤6.00 mm: DCON MS tolerance h6; DC>6.00 mm: Brazed on steel shank with DCON MS tolerance h7.
 Products from this series are also available in set. Please see P880.

Product	DC	DCON MS	LU	OAL
	(mm)	(mm)	(mm)	(mm)
P6113.0X3.0	3.00	3.00	14.00	38.0
P6116.3X3.0	6.30	3.00	12.70	45.0
P6116.0X6.0	6.00	6.00	18.00	50.0
P6118.0X6.0	8.00	6.00	20.00	65.0
P6119.6X6.0	9.60	6.00	19.00	64.0
P6112.7X6.0	12.70	6.00	25.00	70.0

P613



Rotary Burr - Pointed Tree, Shape G

VA single cut flute style with medium spaced edges for multi-angle contouring and cutting narrow angles in hard to reach areas. Carbide design for cutting diameter equal to 6 mm; above 6 mm carbide head with toughened and hardened steel shank. First choice for stainless steels.

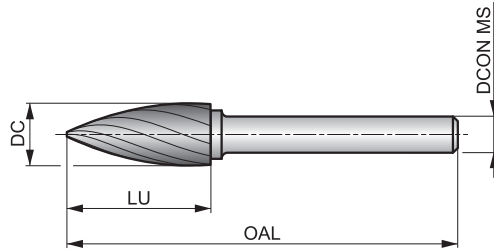

HM	G	Bright
VA	DORMER	



Workpiece material group suitability. Recommended operating speed (RPM) on page 267.

M1.1	M1.2	M2.1	M2.2	M2.3	M3.1	M3.2	M3.3	M4.1	M4.2	K4.1	K4.2
■	■	■	■	■	■	■	■	■	■	▣	▣

DC=6.00 mm: DCON MS tolerance h6; DC>6.00 mm: Brazed on steel shank with DCON MS tolerance h7.

	DC (mm)	DCON MS (mm)	LU (mm)	OAL (mm)
P6136.0X6.0	6.00	6.00	18.00	50.0
P6138.0X6.0	8.00	6.00	19.00	64.0
P6139.6X6.0	9.60	6.00	19.00	64.0
P61312.7X6.0	12.70	6.00	25.00	70.0

P615



Rotary Burr - Flame, Shape H

VA single cut flute style with medium spaced edges for round edge contouring and welding preparation. Carbide head with toughened and hardened steel shank. First choice for stainless steels.

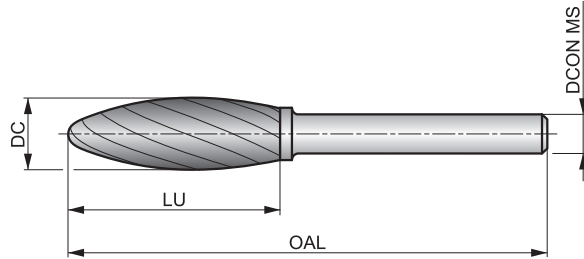

HM	H	Bright
VA	DORMER	



Workpiece material group suitability. Recommended operating speed (RPM) on page 267.

M1.1	M1.2	M2.1	M2.2	M2.3	M3.1	M3.2	M3.3	M4.1	M4.2	K4.1	K4.2
■	■	■	■	■	■	■	■	■	■	☑	☑

Brazed on Steel Shank with DCON MS tolerance h7.

	DC (mm)	DCON MS (mm)	LU (mm)	OAL (mm)
P6158.0X6.0	8.00	6.00	19.00	64.0
P6159.6X6.0	9.60	6.00	19.00	65.0
P61512.7X6.0	12.70	6.00	32.00	77.0

P621



Rotary Burr - Ball Nosed Cone, Shape L

VA single cut flute style with medium spaced edges for enlarging holes, rounding edges and surface finishing in tight narrow angles or other hard to reach areas. Carbide head with toughened and hardened steel shank. First choice for stainless steels.

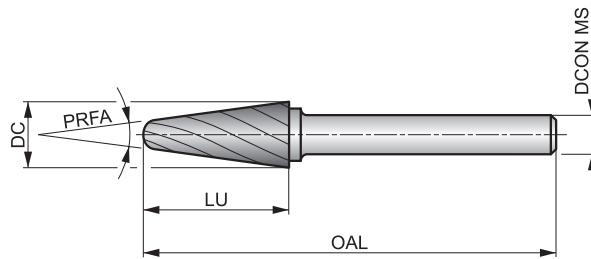

HM		Bright
VA		



Workpiece material group suitability. Recommended operating speed (RPM) on page 267.

M1.1	M1.2	M2.1	M2.2	M2.3	M3.1	M3.2	M3.3	M4.1	M4.2	K4.1	K4.2
■	■	■	■	■	■	■	■	■	■	▣	▣

Brazed on Steel Shank with DCON MS tolerance h7.
Products from this series are also available in set. Please see P880.

Product	DC (mm)	DCON MS (mm)	LU (mm)	OAL (mm)	PRFA (°)
P6218.0X6.0	8.00	6.00	25.40	70.0	14
P62110.0X6.0	10.00	6.00	20.00	65.0	14
P62112.7X6.0	12.70	6.00	32.00	77.0	14

P831



Rotary Burr - Cylinder without endcut, Shape A

AL single cut flute style with wide spaced edges for trimming and deburring surfaces. Carbide design for cutting diameter equal to 6 mm; above 6 mm carbide head with toughened and hardened steel shank. First choice for non-ferrous materials and plastics.

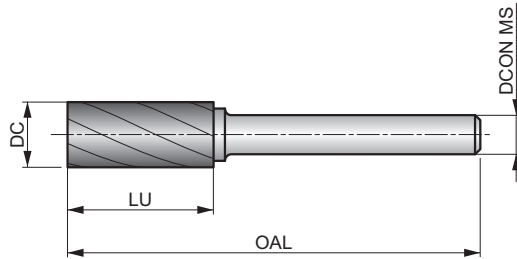

HM	A	Bright
AL	DORMER	



Workpiece material group suitability. Recommended operating speed (RPM) on page 267.

N1.1	N1.2	N1.3	N2.1	N2.2	N2.3	N3.1	N3.2	N4.1	N4.2	N4.3	S1.1
■	■	■	■	■	■	▣	▣	■	■	▣	▣

DC=6.00 mm: DCON MS tolerance h6; DC>6.00 mm: Brazed on steel shank with DCON MS tolerance h7.

Product	DC (mm)	DCON MS (mm)	LU (mm)	OAL (mm)
P8316.0X6.0	6.00	6.00	18.00	50.0
P8319.6X6.0	9.60	6.00	19.00	64.0
P83112.7X6.0	12.70	6.00	25.00	70.0

P833



Rotary Burr - Cylinder with endcut, Shape B

AL single cut flute style with wide spaced edges for trimming and deburring surfaces and right-angled corners. Carbide design for cutting diameter equal to 6 mm; above 6 mm carbide head with toughened and hardened steel shank. First choice for non-ferrous materials and plastics.

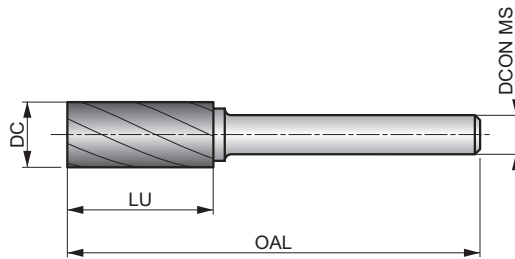

HM	B	
Bright	AL	



Workpiece material group suitability. Recommended operating speed (RPM) on page 267.

N1.1	N1.2	N1.3	N2.1	N2.2	N2.3	N3.1	N3.2	N4.1	N4.2	N4.3	S1.1
■	■	■	■	■	■	▣	▣	■	■	▣	▣

DC=6.00 mm: DCON MS tolerance h6; DC>6.00 mm: Brazed on steel shank with DCON MS tolerance h7.

Product	DC (mm)	DCON MS (mm)	LU (mm)	OAL (mm)
P8336.0X6.0	6.00	6.00	18.00	50.0
P8339.6X6.0	9.60	6.00	19.00	64.0
P83312.7X6.0	12.70	6.00	25.00	70.0

P835



Rotary Burr - Ball Nosed Cylinder, Shape C

AL single cut flute style with wide spaced edges for for trimming and deburring contours and circular arcs. Carbide design for cutting diameter equal to 6 mm; above 6 mm carbide head with toughened and hardened steel shank. First choice for non-ferrous materials and plastics.

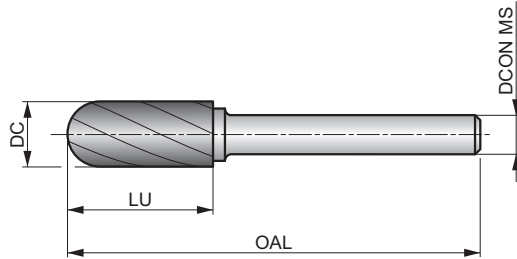

HM	C	Bright
AL		



Workpiece material group suitability. Recommended operating speed (RPM) on page 267.

N1.1	N1.2	N1.3	N2.1	N2.2	N2.3	N3.1	N3.2	N4.1	N4.2	N4.3	S1.1
■	■	■	■	■	■	▣	▣	■	■	▣	▣

DC=6.00 mm: DCON MS tolerance h6; DC>6.00 mm: Brazed on steel shank with DCON MS tolerance h7.

Product	DC (mm)	DCON MS (mm)	LU (mm)	OAL (mm)
P8356.0X6.0	6.00	6.00	18.00	50.0
P8359.6X6.0	9.60	6.00	19.00	64.0
P83512.7X6.0	12.70	6.00	25.00	70.0

P837



Rotary Burr - Ball, Shape D

AL single cut flute style with wide spaced edges for intricate carving, metal engraving and welding preparation. Carbide design for cutting diameter equal to 6 mm; above 6 mm carbide head with toughened and hardened steel shank. First choice for non-ferrous materials and plastics.

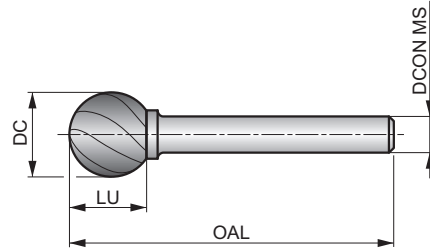

HM		Bright
AL		



Workpiece material group suitability. Recommended operating speed (RPM) on page 267.

N1.1	N1.2	N1.3	N2.1	N2.2	N2.3	N3.1	N3.2	N4.1	N4.2	N4.3	S1.1
■	■	■	■	■	■	▣	▣	■	■	▣	▣

DC=6.00 mm: DCON MS tolerance h6; DC>6.00 mm: Brazed on steel shank with DCON MS tolerance h7.a

Product	DC (mm)	DCON MS (mm)	LU (mm)	OAL (mm)
P8376.0X6.0	6.00	6.00	4.70	50.0
P8379.6X6.0	9.60	6.00	8.00	54.0
P83712.7X6.0	12.70	6.00	11.00	56.0

P841



Rotary Burr - Ball Nosed Tree, Shape F

AL single cut flute style with wide spaced edges for multi-angle contouring, rounding of edges and cutting into hard to reach areas. Carbide design for cutting diameter equal to 6 mm; above 6 mm carbide head with toughened and hardened steel shank. First choice for non-ferrous materials and plastics.

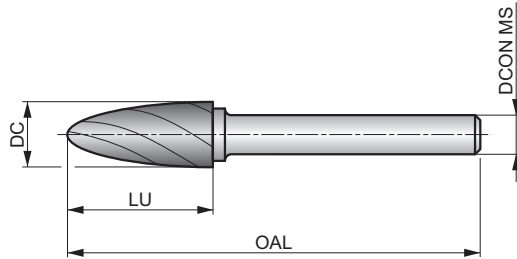

HM	F	Bright
AL	DORMER	



Workpiece material group suitability. Recommended operating speed (RPM) on page 267.

N1.1	N1.2	N1.3	N2.1	N2.2	N2.3	N3.1	N3.2	N4.1	N4.2	N4.3	S1.1
■	■	■	■	■	■	☐	☐	■	■	☐	☐

DC=6.00 mm: DCON MS tolerance h6; DC>6.00 mm: Brazed on steel shank with DCON MS tolerance h7.

Product	DC (mm)	DCON MS (mm)	LU (mm)	OAL (mm)
P8416.0X6.0	6.00	6.00	18.00	50.0
P8419.6X6.0	9.60	6.00	19.00	64.0
P84112.7X6.0	12.70	6.00	25.00	70.0

P842



Rotary Burr - Ball Nosed Cone, Shape L

AL single cut flute style - wide spaced edges for enlarging holes, rounding edges and surface finishing in tight narrow angles or other hard to reach areas. Carbide design for cutting diameter equal to 6 mm; above 6 mm carbide head with toughened and hardened steel shank. First choice for non-ferrous materials and plastics.

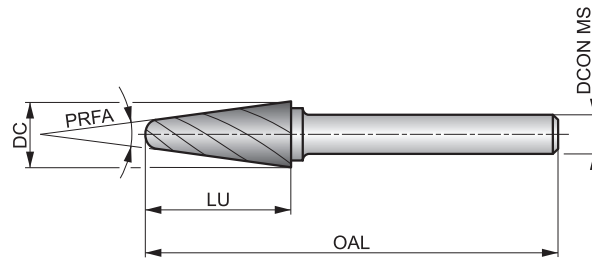

HM	L	Bright
AL	DORMER	



Workpiece material group suitability. Recommended operating speed (RPM) on page 267.

N1.1	N1.2	N1.3	N2.1	N2.2	N2.3	N3.1	N3.2	N4.1	N4.2	N4.3	S1.1
■	■	■	■	■	■	▣	▣	■	■	▣	▣

DC=6.00 mm: DCON MS tolerance h6; DC>6.00 mm: Brazed on steel shank with DCON MS tolerance h7.

Product	DC (mm)	DCON MS (mm)	LU (mm)	OAL (mm)	PRFA (°)
P8426.0X6.0	6.00	6.00	18.00	50.0	14
P8429.6X6.0	9.60	6.00	30.00	76.0	14
P84212.7X6.0	12.70	6.00	32.00	77.0	14



NEW

P501

DORMER



Rotary Burr - Cylinder without endcut, Shape A

AS single cut flute style with light left-hand cross cut for trimming and deburring surfaces. Solid carbide shank for rigidity. First choice for superalloys.

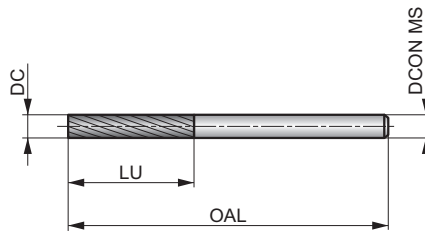

HM	A	Bright
AS	DORMER	



Workpiece material group suitability. Recommended operating speed (RPM) on page 267.

M3.1	M3.2	M3.3	M4.1	M4.2	S1.1	S1.2	S1.3	S2.1	S2.2	S3.1	S3.2	S4.1	S4.2
☑	☑	☑	☑	☑	■	■	■	■	■	■	■	■	■

DCON MS tolerance h6.

Products from this series are also available in set. Please see P880.

Product	DC (mm)	DCON MS (mm)	LU (mm)	OAL (mm)
P5013.0X3.0	3.00	3.00	12.00	38.0



NEW

P505



Rotary Burr - Ball Nosed Cylinder, Shape C

AS single cut flute style with light left-hand cross cut for trimming and deburring contours and circular arcs. Solid carbide shank for rigidity. First choice for superalloys.

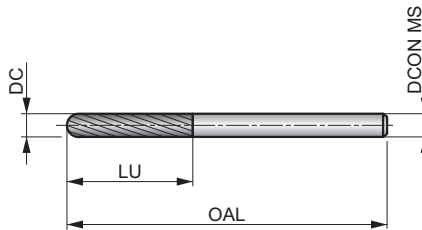

HM	C	Bright
AS	DORMER	



Workpiece material group suitability. Recommended operating speed (RPM) on page 267.

M3.1	M3.2	M3.3	M4.1	M4.2	S1.1	S1.2	S1.3	S2.1	S2.2	S3.1	S3.2	S4.1	S4.2
☑	☑	☑	☑	☑	☐	☐	☐	☐	☐	☐	☐	☐	☐

DCON MS tolerance h6.

Products from this series are also available in set. Please see P880.

Product	DC (mm)	DCON MS (mm)	LU (mm)	OAL (mm)
P5053.0X3.0	3.00	3.00	14.00	38.0



NEW

P507

DORMER



Rotary Burr - Ball, Shape D

AS single cut flute style with light left-hand cross cut for intricate carving, metal engraving and welding preparation. Solid carbide shank for rigidity. First choice for superalloys.

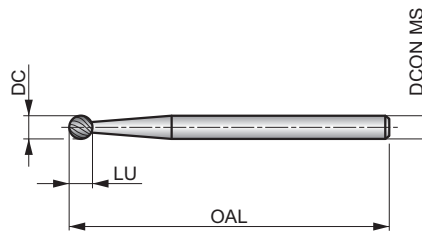

HM	D	Bright
AS		



Workpiece material group suitability. Recommended operating speed (RPM) on page 267.

M3.1	M3.2	M3.3	M4.1	M4.2	S1.1	S1.2	S1.3	S2.1	S2.2	S3.1	S3.2	S4.1	S4.2
<input checked="" type="checkbox"/>	<input checked="" type="checkbox"/>	<input checked="" type="checkbox"/>	<input checked="" type="checkbox"/>	<input checked="" type="checkbox"/>	<input type="checkbox"/>	<input type="checkbox"/>	<input type="checkbox"/>	<input type="checkbox"/>	<input type="checkbox"/>	<input type="checkbox"/>	<input type="checkbox"/>	<input type="checkbox"/>	<input type="checkbox"/>

DCON MS tolerance h6.

Products from this series are also available in set. Please see P880.

Product	DC (mm)	DCON MS (mm)	LU (mm)	OAL (mm)
P5073.0X3.0	3.00	3.00	2.50	38.0



NEW

P509



Rotary Burr - Oval, Shape E

AS single cut flute style with light left-hand cross cut for round edge contouring. Solid carbide shank for rigidity. First choice for superalloys.

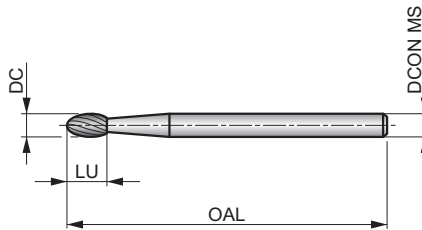

HM	E	Bright
AS	DORMER	



Workpiece material group suitability. Recommended operating speed (RPM) on page 267.

M3.1	M3.2	M3.3	M4.1	M4.2	S1.1	S1.2	S1.3	S2.1	S2.2	S3.1	S3.2	S4.1	S4.2
☑	☑	☑	☑	☑	☐	☐	☐	☐	☐	☐	☐	☐	☐

DCON MS tolerance h6.
Products from this series are also available in set. Please see P880.

Product	DC (mm)	DCON MS (mm)	LU (mm)	OAL (mm)
P5093.0X3.0	3.00	3.00	6.00	38.0



NEW

P511

DORMER



Rotary Burr - Ball Nosed Tree, Shape F

AS single cut flute style with light left-hand cross cut for multi-angle contouring, rounding of edges and cutting into hard to reach areas. Solid carbide shank for rigidity. First choice for superalloys.

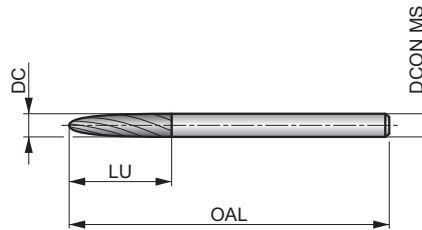

HM	F	Bright
AS		



Workpiece material group suitability. Recommended operating speed (RPM) on page 267.

M3.1	M3.2	M3.3	M4.1	M4.2	S1.1	S1.2	S1.3	S2.1	S2.2	S3.1	S3.2	S4.1	S4.2
<input checked="" type="checkbox"/>	<input checked="" type="checkbox"/>	<input checked="" type="checkbox"/>	<input checked="" type="checkbox"/>	<input checked="" type="checkbox"/>	<input type="checkbox"/>	<input type="checkbox"/>	<input type="checkbox"/>	<input type="checkbox"/>	<input type="checkbox"/>	<input type="checkbox"/>	<input type="checkbox"/>	<input type="checkbox"/>	<input type="checkbox"/>

DCON MS tolerance h6.

Products from this series are also available in set. Please see P880.

Product	DC [mm]	DCON MS [mm]	LU [mm]	OAL [mm]
P5113.0X3.0	3.00	3.00	14.00	38.0

NEW

P513

DORMER



Rotary Burr - Pointed Tree, Shape G

AS single cut flute style with light left-hand cross cut for multi-angle contouring and cutting narrow angles in hard to reach areas. Solid carbide shank for rigidity. First choice for superalloys.

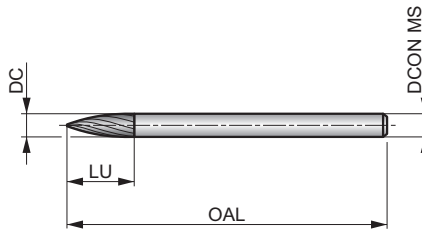

HM	G	Bright
AS	DORMER	



Workpiece material group suitability. Recommended operating speed (RPM) on page 267.

M3.1	M3.2	M3.3	M4.1	M4.2	S1.1	S1.2	S1.3	S2.1	S2.2	S3.1	S3.2	S4.1	S4.2
☑	☑	☑	☑	☑	☐	☐	☐	☐	☐	☐	☐	☐	☐

DCON MS tolerance h6.
Products from this series are also available in set. Please see P880.

Product	DC (mm)	DCON MS (mm)	LU (mm)	OAL (mm)
P5133.0X3.0X8.0	3.00	3.00	8.00	38.0
P5133.0X3.0X14.0	3.00	3.00	14.00	38.0



NEW

P515

DORMER



Rotary Burr - Flame, Shape H

AS single cut flute style with light left-hand cross cut for round edge contouring and welding preparation. Solid carbide shank for rigidity. First choice for superalloys.

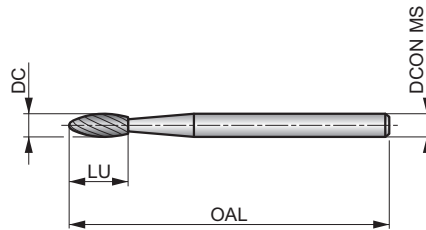

HM	H	Bright
AS	DORMER	



Workpiece material group suitability. Recommended operating speed (RPM) on page 267.

M3.1	M3.2	M3.3	M4.1	M4.2	S1.1	S1.2	S1.3	S2.1	S2.2	S3.1	S3.2	S4.1	S4.2
☑	☑	☑	☑	☑	■	■	■	■	■	■	■	■	■

DCON MS tolerance h6.
Products from this series are also available in set. Please see P880.

Product	DC (mm)	DCON MS (mm)	LU (mm)	OAL (mm)
P5153.0X3.0	3.00	3.00	6.00	38.0

NEW

P521

DORMER



Rotary Burr - Ball Nosed Cone, Shape L

AS single cut flute style with light left-hand cross cut for enlarging holes, rounding edges and surface-finishing in tight narrow angles or other hard to reach areas. Solid carbide shank for rigidity. First choice for superalloys.

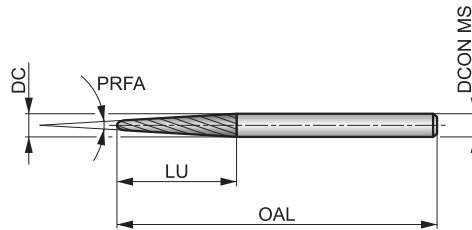

HM	L	Bright
AS	DORMER	



Workpiece material group suitability. Recommended operating speed (RPM) on page 267.

M3.1	M3.2	M3.3	M4.1	M4.2	S1.1	S1.2	S1.3	S2.1	S2.2	S3.1	S3.2	S4.1	S4.2
☑	☑	☑	☑	☑	☐	☐	☐	☐	☐	☐	☐	☐	☐

DCON MS tolerance h6.
Products from this series are also available in set. Please see P880.

Product	DC (mm)	DCON MS (mm)	LU (mm)	OAL (mm)	PRFA (°)
P5213.0X3.0	3.00	3.00	14.00	38.0	8



NEW

P523

DORMER



Rotary Burr - Cone, Shape M

AS single cut flute style with light left-hand cross cut for enlarging holes, surface finishing and cutting narrow angles in hard to reach areas. Solid carbide shank for rigidity. First choice for superalloys.

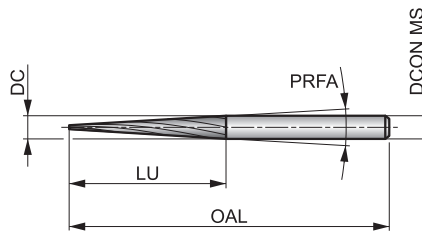

HM		Bright
AS		



Workpiece material group suitability. Recommended operating speed (RPM) on page 267.

M3.1	M3.2	M3.3	M4.1	M4.2	S1.1	S1.2	S1.3	S2.1	S2.2	S3.1	S3.2	S4.1	S4.2
☑	☑	☑	☑	☑	■	■	■	■	■	■	■	■	■

DCON MS tolerance h6.

Products from this series are also available in set. Please see P880.

Product	DC (mm)	DCON MS (mm)	LU (mm)	OAL (mm)	PRFA (°)
P5233.0X3.0	3.00	3.00	15.00	38.0	7

P843



Diamond Cut Router - 135° Drill Point

GRP diamond cut flute style with medium spaced edges for contouring, making cut-out shapes and holes. Solid carbide shank for rigidity. First choice for fibreglass and composite materials.

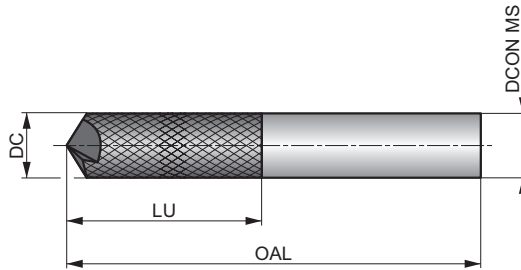

HM		Bright
	GRP	



Workpiece material group suitability. Recommended operating speed (RPM) on page 267.

N4.3

DCON MS tolerance h6.

Product	DC (mm)	DCON MS (mm)	LU (mm)	OAL (mm)
P8433.0X3.0	3.00	3.00	13.00	45.0
P8436.0X6.0	6.00	6.00	19.00	63.0
P8438.0X8.0	8.00	8.00	25.00	63.0

P844

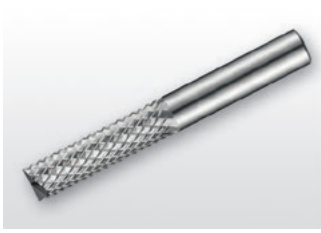

Diamond Cut Router - End Mill

GRP diamond cut flute style with medium spaced edges for contouring, groove and pocket milling and making cut-out shapes. Solid carbide shank for rigidity. First choice for fibreglass and composite materials.

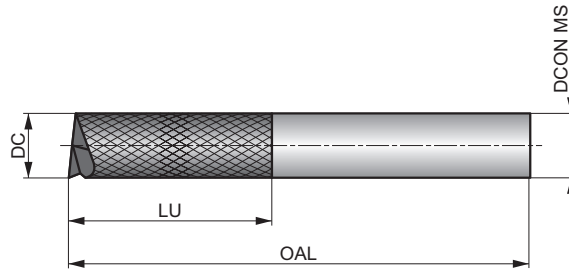

HM		Bright
	GRP	



Workpiece material group suitability. Recommended operating speed (RPM) on page 267.

N4.3

DCON MS tolerance h6.

Product	DC (mm)	DCON MS (mm)	LU (mm)	OAL (mm)
P8443.0X3.0	3.00	3.00	13.00	45.0
P8446.0X6.0	6.00	6.00	19.00	63.0
P8448.0X8.0	8.00	8.00	25.00	63.0

NEW

P100

DORMER



1st Stage Rotary Burr for Broken Bolt Removal, Cylinder with End Cut

First stage broken bolt removal solid carbide burr. When a bolt is broken and needs to be extracted, first use P100 to flatten the broken bolt surface. Secondly use P101. This series of burrs makes sure the threaded hole is not damaged when removing the broken piece.

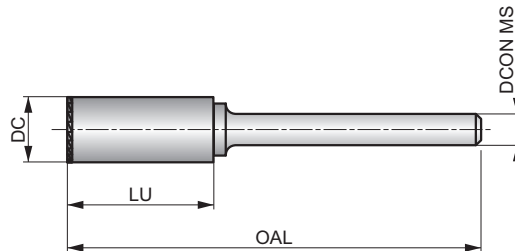

HM		Bright
BR		



Workpiece material group suitability. Recommended operating speed (RPM) on page 267 and 'how to use the tool' on page 256.

P1.1	P1.2	P1.3	P2.1	P2.2	P2.3	P3.1	P3.2	P3.3	P4.1	P4.2	M1.1	M1.2	M2.1
■	■	■	■	■	■	■	■	■	■	■	■	■	■
M2.2	M2.3	M3.1	M3.2	M3.3									
■	■	■	■	■									

Product	DC	DCON MS	LU	OAL	
	(mm)	(mm)	(mm)	(mm)	
P1004.9	4.90	6.00	20.00	50.0	1/4-20; 24; 28; M6
P1006.4	6.40	6.00	5.00	50.0	5/16-18; 24; 32; M8
P1007.8	7.80	6.00	19.00	65.0	3/8-16; 24; M10
P1009.3	9.30	6.00	19.00	65.0	7/16-14; 20; M12
P10010.7	10.70	6.00	25.00	70.0	1/2-13; 20; M14

NEW

P101

DORMER



2nd Stage Rotary Burr for Broken Bolt Removal, 150° Countersink

Second stage broken bolt removal solid carbide burr. When a bolt is broken and needs to be extracted, P101 creates a centerpoint into the flattened broken bolt. Prepare it for the 3rd stage, drilling the broken piece with a drill.

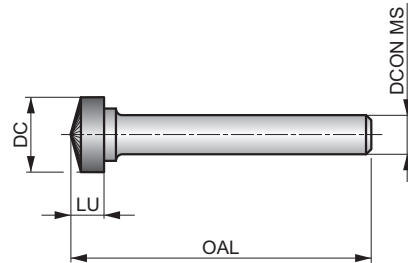

HM	Bright	150°
BR	DORMER	



Workpiece material group suitability. Recommended operating speed (RPM) on page 267 and 'how to use the tool' on page 256.

P1.1	P1.2	P1.3	P2.1	P2.2	P2.3	P3.1	P3.2	P3.3	P4.1	P4.2	M1.1	M1.2	M2.1
■	■	■	■	■	■	■	■	■	■	■	■	■	■
M2.2	M2.3	M3.1	M3.2	M3.3									
■	■	■	■	■									

Product	DC	DCON MS	LU	OAL	
	(mm)	(mm)	(mm)	(mm)	
P1014.9	4.90	6.00	20.00	50.0	1/4-20; 24; 28; M6
P1016.4	6.40	6.00	5.00	50.0	5/16-18; 24; 32; M8
P1017.8	7.80	6.00	5.00	50.0	3/8-16; 24; M10
P1019.3	9.30	6.00	5.00	50.0	7/16-14; 20; M12
P10110.7	10.70	6.00	5.00	50.0	1/2-13; 20; M14

**NEW****P880****DORMER****Rotary Burr Set**

Set of different rotary burrs in various shapes, sizes and forms.

A=Styles in Set, B=No. in Set, C=Rotary Burrs in Set.

Product	Nr.	A	B	C
P88001	Nr01	P803 + P805 + P807 + P809 + P813	5	P803 9.6 × 6.0; P805 9.6 × 6.0; P807 9.6 × 6.0; P809 9.6 × 6.0; P813 9.6 × 6.0
P88002	Nr02	P803C + P805C + P807C + P811C + P813C	5	P803C 9.6 × 6.0; P805C 9.6 × 6.0; P807C 9.6 × 6.0; P811C 9.6 × 6.0; P813C 9.6 × 6.0
P88003	Nr03	P601 + P605 + P607 + P611 + P621	5	P601 9.6 × 6.0; P605 9.6 × 6.0; P607 9.6 × 6.0; P611 9.6 × 6.0; P621 10.0 × 6.0
P88004	Nr04	P703 + P705 + P707 + P711 + P721	5	P703 9.6 × 6.0; P705 9.6 × 6.0; P707 9.6 × 6.0; P711 9.6 × 6.0; P721 10.0 × 6.0
P88006	Nr06	P501 + P505 + P507 + P509 + P511 + P513 + P515 + P521 + P523	10	P501 3.0 × 3.0; P505 3.0 × 3.0; P507 3.0 × 3.0; P509 3.0 × 3.0; P511 3.0 × 3.0; P513 3.0 × 3.0 × 8.0; P513 3.0 × 3.0 × 14.0; P515 3.0 × 3.0; P521 3.0 × 3.0; P523 3.0 × 3.0



P890



Rotary Burrs Display

Display of 40 pieces of solid burrs of the P8xx serie. DC double cut flute style with close spaced edges. Bright finish.

A=Styles in Set, B=No. in Set, C=Rotary Burrs in Set.

Product	Nr.	A	B	C
P89001	Nr01	P803 + P805 + P811 + P813 + P821	40	P803 (6.0 × 6.0; 8.0 × 6.0; 9.6 × 6.0; 12.7 × 6.0) × 2 P805 (6.0 × 6.0; 8.0 × 6.0; 9.6 × 6.0; 12.7 × 6.0) × 2 P811 (6.0 × 6.0; 8.0 × 6.0; 9.6 × 6.0; 12.7 × 6.0) × 2 P813 (6.0 × 6.0; 8.0 × 6.0; 9.6 × 6.0; 12.7 × 6.0) × 2 P821 (6.0 × 6.0; 8.0 × 6.0; 9.6 × 6.0; 12.7 × 6.0) × 2

ROTARY BURRS – GENERAL HINTS

General hints on carbide burrs

Carbide Burrs are widely used for preparing and finishing components in a wide range of materials. They are generally used by hand and mounted in air driven die-grinders.

Construction and Geometry

1. Toughened and hardened steel shanks improve rigidity and reduce the risk of bending or vibration.
2. Accurately ground shanks improve holding and reduce likelihood of spinning.
3. Special brazing elements prevent high temperature failure and also provide increased strength to withstand pressure and impact.
4. The universal Double Cut (DC) geometry is suitable for a wide range of materials and applications.
5. Material specific geometries are also available suited to Steel (ST), Stainless Steel (VA), Aluminium (AL), Super Alloys (AS) and Fibreglass (GRP).
6. Available with TiAlN coating to increase tool life in abrasive materials.
7. Ball nose burrs are ground with Skip Flute geometry. This provides active geometry towards the centre of the burr, improving the cutting action and reducing the chances of swarf build up and clogging.

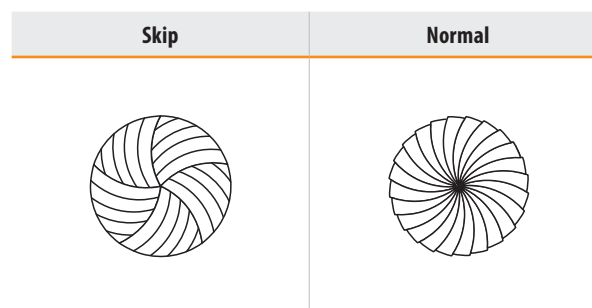

Safety first

1. High speed rotating tools are hazardous and can be dangerous if miss-used.
2. Always disconnect the die grinder from the air supply before attempting to change the burrs.
3. Check the condition of the die grinder and if possible use low vibration versions.
4. Always use the appropriate protective equipment and ensure anyone working close by is also protected.



Personal protective equipment must be worn at all times!



ROTARY BURRS – GENERAL HINTS

Recommendations

- Always use the appropriate speed rated die grinder.
- Routine maintenance of die grinders is important, ensure they are oiled and bearings are not worn.
- Always clean the clamping nut, collet and internal taper of the die grinder when changing a burr.
- Try to avoid mechanical shock and heavy impact of the burrs.
- Try to avoid thermal shock by not allowing the burr to become overheated.
- Don't plunge the burr too deep into the workpiece material or jam the bur into corners or channels.

Trouble shooting using burrs

Problem	Cause
Chipping of Burr Teeth	Running speed too low (revolutions per minute) can cause bouncing (chatter).
	Eccentricity (worn spindle, collet or bearings).
	Plunging and jamming the burr into the workpiece.
Clogging of Burr Teeth	Flute length or overall length too long.
	Incorrect geometry choice for workpiece material.
Premature Wear	Running speed too high (revolutions per minute) for size of burr and workpiece material.
	Eccentricity (worn spindle, collet or bearings).
Head Detaches from Shank	Running speed too high (revolutions per minute) causing overheating.
	Running for prolonged periods causing overheating.

CUTTING FLUIDS





M200-1



M200 no. 1 Blue, Cutting Fluid for Heavy Machining

A high performance cutting oil for difficult operations, such as tapping, broaching and drilling by hand or with a pillar drill. For increased tool life and improved surface finishes. First choice recommendation for high strength steel, stainless steel and super alloys.

Product	Nr.
M2000.25NR.1BLUE	1/4 Ltr. 12×
M2001.0NR.1BLUE	1 Ltr.
M2005.0NR.1BLUE	5 Ltr.
M20020.0NR.1BLUE	20 Ltr.

M200-2



M200 no. 2 Red, Cutting Fluid for Non-Ferrous Metals

A neat oil for machining operations requiring chip removal in aluminium and its alloys. For lubrication and cooling to promote long tool life and ensure excellent surface finish. Low impact on the environment due to excellent anti-mist properties, high oxidation stability and low odours.

Product	Nr.
M2000.25NR.2RED	1/4 Ltr. 12×
M2001.0NR.2RED	1 Ltr.
M2005.0NR.2RED	5 Ltr.



M200-3



M200 no. 3 Green, Cutting Fluid for General Purpose Machining

A high performance cutting oil with extreme pressure (EP) additives to provide longer tool life. For general cutting or forming operations, such as tapping, broaching and drilling in steel or cast steel and stainless steel.

Product	Nr.
M2000.25NR.3GREEN	1/4 Ltr. 12×
M2001.0NR.3GREEN	1 Ltr.
M2005.0NR.3GREEN	5 Ltr.



DELIVERING THE FAB FOUR

We have revamped our general metric product catalogues, featuring more than **20,000** cutting tools. The four publications cover the main application categories – holemaking, milling, turning and threading. Download your copy today!

Simply Reliable.



SIMPLY RELIABLE

As a professional you can judge the quality of work by just looking at the chip. Our chip is a clean and uncomplicated shape that in itself tells a story. It is a clear and consistent signal and that's why we use it as a symbol for being **Simply Reliable**.

DORMER PRAMET

Austria

T: +31 10 2080 240
info.at@dormerpramet.com

Belgium & Luxembourg

T: +32 3 440 59 01
info.be@dormerpramet.com

Brazil

T: +55 11 5660 3000
info.br@dormerpramet.com

Canada

T: (888) 336 7637
En Français: (888) 368 8457
cs.canada@dormerpramet.com

China

T: +86 21 2416 0508
info.cn@dormerpramet.com

Croatia

T: +385 98 407 489
info.hr@dormerpramet.com

Czech Republic

T: +420 583 381 111
info.cz@dormerpramet.com

Denmark

T: 808 82106
info.se@dormerpramet.com

Finland

T: 0205 44 7003
info.fi@dormerpramet.com

France

T: +33 (0)2 47 62 57 01
info.fr@dormerpramet.com

Germany

T: +49 9131 933 08 70
info.de@dormerpramet.com

Hungary

T: +36-96 / 522-846
info.hu@dormerpramet.com

India

T: +91 11 4601 5686
info.in@dormerpramet.com

Italy

T: +39 02 30 70 54 44
info.it@dormerpramet.com

Kazakhstan

T: +7 771 305 11 45
info.kz@dormerpramet.com

Mexico

T: +52 (555) 7293981
cs.mexico@dormerpramet.com

Netherlands

T: +31 10 2080 240
info.nl@dormerpramet.com

Norway

T: 800 10 113
info.se@dormerpramet.com

Poland

T: +48 32 78-15-890
info.pl@dormerpramet.com

Portugal

T: +351 21 424 54 21
info.pt@dormerpramet.com

Romania

T: +4(0)730 015 885
info.ro@dormerpramet.com

Russia

T: +7 (495) 775 10 28
info.ru@dormerpramet.com

Slovakia

T: +421 (41) 764 54 60
info.sk@dormerpramet.com

Slovenia

T: +385 98 407 489
info.si@dormerpramet.com

Spain

T: +34 935717722
info.es@dormerpramet.com

Sweden

responsible for Iceland
T: +46 35 16 52 96
info.se@dormerpramet.com

Switzerland

T: +31 10 2080 240
info.ch@dormerpramet.com

Turkey

T: +90 533 212 45 47
info.tr@dormerpramet.com

Ukraine

T: +38 067 566 38 80
T: +38 067 566 81 51
info.ua@dormerpramet.com

United Kingdom

responsible for Ireland
T: 0870 850 4466
info.uk@dormerpramet.com

United States of America

T: (800) 877-3745
cs@dormerpramet.com

Other countries

South America

T: +55 11 5660 3000
info.br@dormerpramet.com

Adria

T: +420 583 381 527
info.rcee@dormerpramet.com

Rest of the World

Dormer Pramet International UK
T: +44 1246 571338
info.int@dormerpramet.com

Dormer Pramet International CZ
T: +420 583 381 520
info.int.cz@dormerpramet.com

DOR-CAT-MRO-2022-EN

FOLLOW US...



www.dormerpramet.com



[youtube.com/dormerpramet](https://www.youtube.com/dormerpramet)



[facebook.com/dormerprametsocial](https://www.facebook.com/dormerprametsocial)



[linkedin.com/company/dormerpramet](https://www.linkedin.com/company/dormerpramet)



[instagram.com/dormerprametsocial](https://www.instagram.com/dormerprametsocial)



twitter.com/dormerpramet