

Katalog 2023



BAHCO



Katalog 2023

Katalog

Innehåll	2-9
Alfanumeriskt index	657-737
Garanti	751

11-20 BANDSÅGLAD OCH MASKINSÅGLAD



21-36 FILAR



37-60 DRAGVERKTYG



61-104 HYLSOR OCH SPÄRRHANDTAG



105-122 MOMENTVERKTYG



123-186 MASKINDRIVNA VERKTYGSTILLBEHÖR



BAHCO

187-220 SKRUVMEJSLAR



221-230 VINKELSKRUVMEJSLAR



231-264 TÄNGER



265-272 RÖRVERKTYG



273-288 TRYCKLUFTSVERKTYG



289-294 SLADDLÖSA ELEKTRISKA HANDVERKTYG



479-500 VERKTYG FÖR ARBETE PÅ HÖG HÖJD



501-516 ISOLERADE VERKTYG



517-536 GNISTFRIA VERKTYG



537-542 VERKTYG I ROSTFRITT STÅL



543-550 PINCETTER OCH SPECIALVERKTYG FÖR ELEKTRONIK



551-560 MÄTNING OCH MÄRKNING



561-568 VÄGGVERKTYG



569-572 BÅGFILAR



573-582 HANDSÅGAR



583-588 STÄMJÄRN



589-600 SAXAR OCH KNIVAR



601-604 TVINGAR OCH SKRUVSTYCKEN



605-612 HAMMARE



613-616 SKOGSHANDVERKTYG



617-624 HUGGMEJSLAR OCH DORNAR



625-628 BRYTJÄRN



629-632 PLANTERINGS- OCH ODLINGSVERKTYG



633-652 BESKÄRNINGSVKTYG



653-656 TRYCKLUFTSVERKTYG FÖR UTMOMHUSBRUK



Innehåll

Bandsågblad och maskinsågblad	11-20	Skruvmejslar	187-220
BANDSÅGBLAD AV BIMETALL FÖR METALLKAPNING	12	ERGO™ SKRUVMEJSLAR MED GUMMIGREPP OCH FÄRG-ID	188
BANDSÅGBLAD AV HÅRDMETALL FÖR METALLKAPNING	15	ERGO™ SKRUVMEJSLAR MED STÖTTÅLIGT GREPP	198
HSS KAPKLINGOR	17	BAHCOFIT-SKRUVMEJSLAR MED RÄFFLAT GUMMIGREPP	200
TRÄKAPNING	18	SKRUVMEJSLAR MED GUMMIGREPP	207
TILLBEHÖR TILL BANDSÅGNING	18	SKRUVMEJSLAR MED GREPP MED SPÄRRFUNKTION	210
MASKINSÅGBLAD	19	SKRUVMEJSLAR MED PRECISIONSGREPP	212
		SKRUVMEJSLAR MED T-HANDTAGSGREPP	214
Filar	21-36	SKRUVMEJSLAR MED 1/4" BITSHÅLLARE	216
VERKSTADSFILAR	22	SKRUVMEJSLAR MED TRÄ- ELLER PLASTGREPP	216
SKÄRPFILAR	26	SPÄNNINGSPROVARE	218
RASPAR	30	TILLBEHÖR	219
FRÄSTA FILAR	31		
NÅLFILAR	31	Vinkelskruvmejslar	221-230
DIAMANTFILAR	34	INSEX	222
TILLBEHÖR	35	TORX®	226
		VINKELSKRUVMEJSLAR	229
Dragverktyg	37-60	MULTIVERKTYG	229
SKIFTNYCKLAR	38		
U-RINGNYCKLAR	40	Tänger	231-264
SPÄRRNYCKLAR	45	KLIPPANDE TÄNGER	232
U-NYCKLAR	48	KOMBINATIONSTÄNGER	239
RINGNYCKLAR	52	HÅLLANDE TÄNGER	241
ÖPPNA NYCKLAR	54	POLYGRIP-TÄNGER	247
SLAGNYCKLAR	55	SPÄRRINGSTÄNGER	249
HYLSNYCKLAR	56	AVISOLERINGS- OCH SKALTÄNGER	251
SATS MED AVSTÄNGARE	59	CRIMPTÄNGER	254
HAKNYCKLAR	60	TÅNGSATSER	257
		LÅSANDE TÄNGER	259
Hylsor och spärrhandtag	61-104	NITVERKTYG	262
HYLSNYCKELSATSER	62	SPECIALTÄNGER	264
1/4"	79		
3/8"	86	Rörverktyg	265-272
1/2"	92	RÖRTÄNGER	266
3/4"	100	RÖRAVSKÄRARE	268
1"	102	BOCKNING- OCH FORMNINGSVKTYG	270
TOMMA PLASTLÅDOR FÖR HYLSNYCKELSATSER	104	AVGRADNINGSVKTYG	271
STÄLLNINGSNYCKLAR	104		
		Tryckluftswerktyg	273-288
Momentverktyg	105-122	MUTTERDRAGARE	274
DIGITALA MOMENTNYCKLAR	106	SPÄRRHANDTAG	277
MEKANISKA MOMENTNYCKLAR	108	FIL-, SLIP- OCH POLERMASKINER	277
MOMENTSKRUVMEJSLAR	113	BORRMASKINER OCH SKRUVDRAGARE	282
MOMENTOMVANDLARE	115	SKÄRANDE VERKTYG	283
MOMENTPROVARE	116	MEJSELHAMMARE, NITPISTOLER OCH GRAVYRPENNOR	284
MOMENTVINKELADAPTRAR	117	FÄRGSPRUTOR	285
INSTICKSVKTYG	117	BLÅS- OCH RENGÖRINGSVERKTYG	286
		TRYCKLUFTSVKTYG - TILLBEHÖR OCH UTRUSTNING	286
Maskindrivna verktygstillbehör	123-186		
HÅLSÅGAR	124	Sladdlösa elektriska handverktyg	289-294
TIGERSÅGBLAD	134	MUTTERDRAGARE	290
STICKSÅGBLAD	138	SPÄRRHANDTAG	290
MULTIVERKTYGSTILLBEHÖR	139	BORRMASKINER OCH SKRUVDRAGARE	291
CIRKELSÅGKLINGOR	141	FIL-, SLIP- OCH POLERMASKINER	292
SLIP- OCH KAPSKIVOR	142	SKÄRANDE VERKTYG	292
BANDSÅGBLAD	143	FETTSPRUTOR	293
ROTERANDE HÅRDMETALLFILAR	144	BATTERIER OCH LADDARE	293
BÖRRAR	148		
BITS	156		
KRAFTVERKTYG	172		



Fordonsverktyg 295-358

MOTORVERKTYG	296
AVGASSYSTEMSVERKTYG	318
OLJESERVICEVERKTYG OCH UTRUSTNING	319
BROMSSYSTEMSVERKTYG OCH UTRUSTNING	325
VÄXELLÅDE- OCH HJULVERKTYG	328
HJULUPPHÄNGNINGSVKTYG OCH UTRUSTNING	336
BATTERIHANTERING- OCH ELSYSTEMSVERKTYG	337
PRESSAR OCH TILLBEHÖR	342
VERKSTADSUTRUSTNING	343
KAROSSERIVERKTYG	345
LYFTUTRUSTNING	350

Belysningsutrustning 359-360

FICKLAMPOR	360
STRÅLKASTARE	360
KABELVINDOR	360

Inspektionsverktyg 361-364

ENDOSKOP	362
STETOSKOP	362
SPEGLAR	362

Avdragare och bräckjärn 365-374

MEKANISKA	366
BRÄCKJÄRN	372
PLOCKNINGSVKTYG	373
GÄNGVERKTYG	373

Verktygsförvaring och verktygssatser 375-478

VERKTYGSSVAGNAR	376
FIT&GO VERKTYGSSATSER I SKUMPLASTINLÄGG	384
VERKTYGSSATSER FÖR SPECIALAPPLIKATIONER	434
VERKTYGSVÄSKA I PLAST	457
ARBETSBÄNK	463
VERKTYGSSKÅP OCH VERKTYGSTAVLOR	467
VERKTYGSLÅDOR I METALL	470
TEXTIL- OCH LÄDERUTRUSTNING	472
PLASTLÅDOR OCH VÄSKOR	477
VERKTYGSSATSER	478

Verktyg för arbete på hög höjd 479-500

VERKTYGSFÖRVARING OCH SÄKERHETSLINOR	480
DRAGVERKTYG	483
RÖRTÄNGER	485
HYLSOR OCH SPÄRRHANDTAG	485
SKRUVMEJSLAR	488
TÄNGER	491
SKÄRANDE OCH SÅGANDE VERKTYG	493
HAMMARE, BRÄCKJÄRN OCH STÄMJÄRN	494
MÄTNING OCH MÄRKNING	496
MOMENTVERKTYG	497
TVINGAR	498
ÖVRIGA VERKTYG	498
SKYDDSHANDSKAR	499

Isolerade verktyg 501-516

SKRUVMEJSLAR	502
TÄNGER	509
DRAGVERKTYG	511
ISOLERADE HYLSOR OCH SPÄRRHANDTAG	512
SAXAR OCH KNIVAR	513

PINCETTER	513
SKYDDSDRUSTNING	513
VERKTYGSSATSER	514

Gnistfria verktyg 517-536

DRAGVERKTYG	518
RÖRVERKTYG OCH VENTILVERKTYG	523
HYLSOR OCH SPÄRRHANDTAG	524
SKRUVMEJSLAR	527
TÄNGER	528
HAMMARE, BRÄCKJÄRN OCH STÄMJÄRN	530
FÄRGSKRAPA	533
PLANTERINGSDREDSKAP M.M.	535
AVDRAGARE OCH BRÄCKJÄRN	535
MOMENTVERKTYG	536

Verktyg i rostfritt stål 537-542

VERKTYGSSVAGN	538
DRAGVERKTYG	538
HYLSOR OCH SPÄRRHANDTAG	539
SKRUVMEJSLAR	540
VINKELSKRUVMEJSLAR	540
BITS	541
TÄNGER	542
HAMMARE	542
DORN OCH HUGGMEJSLAR	542

Pincetter och specialverktyg för elektronik 543-550

PINCETTER	544
LÖDVERKTYG	547
SPECIALVERKTYG FÖR FINMEKANIK	548

Mätning och märkning 551-560

MÄTTBAND	552
MÄTHJUL	553
VATTENPASS	553
MÄRKNING	556
LINJALER	557
VINKELHAKAR	558
PRECISIONSMÄTNING	559

Väggverktyg 561-568

FÄRGSKRAPA	562
MURARVERKTYG	564
VERKTYG FÖR GIPSVÄGGAR	566

Bågflar 569-572

BÅGFLAR	570
BÅGFILSBLAD	571

Handsågar 573-582

HANDSÅGAR FÖR BYGGMATERIAL	574
HANDSÅGAR FÖR TRÄ	575
PRECISIONSHANDSÅGAR	579
HANDTAG OCH SKÄRPVERKTYG	580
LÖVSÅGAR OCH SÅGBLAD	580
FIGURSÅGAR OCH SÅGBLAD	581
MUSIKSÅG	581

Stämjärn 583-588

STÄMJÄRN FÖR TRÄBEARBETNING	584
SKÖLPAR	586
STÄMJÄRN FÖR GROVARBETE	586
TILLBEHÖR TILL STÄMJÄRN	587

Saxar och knivar 589-600

PLÅTSAXAR	590
SAXAR	593
KNIVAR	594

Tvingar och skruvstycken 601-604

TVINGAR	602
SKRUVSTYCKEN, BÄNKMODELL	603
TILLBEHÖR TILL BÄNKSKRUVSTYCKEN	604

Hammare 605-612

KLOHAMMARE	606
SPIKUTDRAGARE	607
VERKSTADSHAMMARE	607
SPECIALHAMMARE	608
SPECIALHAMMARE	610
SLÄGGOR	610
HAMMARE MED MJUK SLAGYTA OCH GUMMIHAMMARE	611

Skogshandverktyg 613-616

YXOR, RÖJYXOR OCH SLÄGGOR	614
KILAR	616

Huggmejslar och dornar 617-624

HUGGMEJSLAR	618
HUGGMEJSLAR MED SKYDD	619
HUGGMEJSLAR, OMSLIPNINGSBARA	619
HUGGMEJSLAR - TILLBEHÖR	620
DORN	620
DORN MED TVÅKOMPLEMENTSHANDTAG	624
HUGGMEJSLAR MED	624
TVÅKOMPLEMENTSHANDTAG	

Brytjärn 625-628

BRÄCKJÄRN	626
-----------	-----

Planterings- och odlingsverktyg 629-632

SKYFFLAR	630
SPADAR	630
GREPAR	630
KRATTOR	630
SMÅ TRÄDGÅRDSVERKTYG	630

Beskärningsverktyg 633-652

SEKATÖRER	634
FRUKTPLOCKNINGSVKTYG	638
GREN- OCH RÖJSAXAR	639
TOPPSAXAR OCH SÅGAR FÖR TELESKOPSKAFT	641
HÄCKSAXAR	644
GRÄSSAXAR	646
TRÄDGÅRDSKNIVAR	646

SAXAR	647
BÅGSÅGAR	647
BESKÄRNINGSSÅGAR	648
RESERVDELAR OCH TILLBEHÖR	650
TILLBEHÖR OCH UNDERHÅLL	651

Tryckluftswerktyg för utomhusbruk 653-656

SEKATÖRER	654
-----------	-----



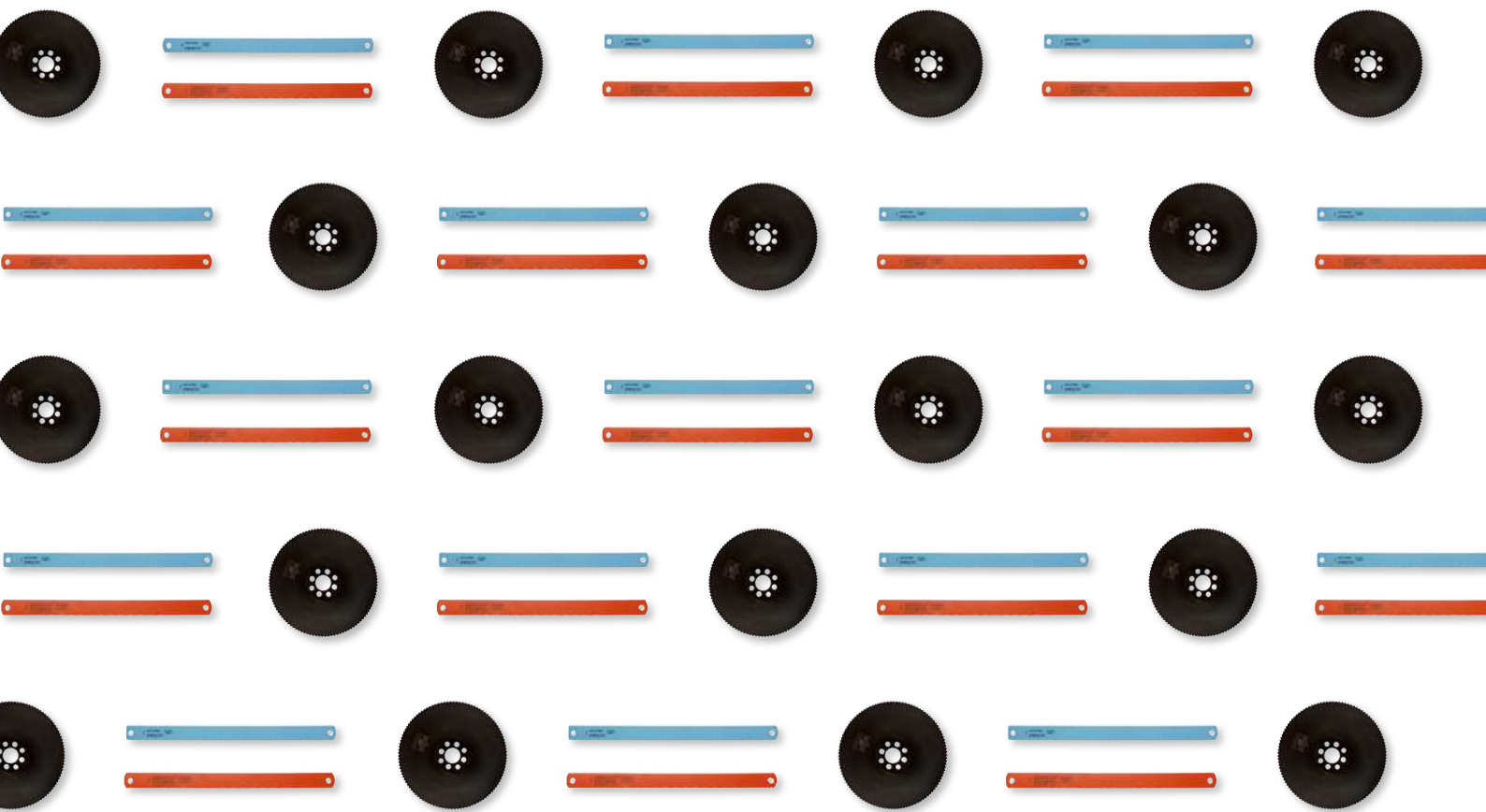

Bandsågblad och maskinsågblad



BANDSÅGBLAD AV BIMETALL FÖR METALLKAPNING

Universalbandsågblad för mindre verkstäder

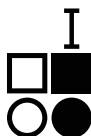
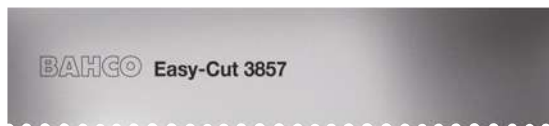

3857 Easy-Cut

13 mm	EZ	1	3857-13-0.6-EZ-S
13 mm	EZ	1	3857-13-0.6-EZ-M
13 mm	EZ	1	3857-13-0.6-EZ-L
20 mm	EZ	1	3857-20-0.9-EZ-S
20 mm	EZ	1	3857-20-0.9-EZ-M
20 mm	EZ	1	3857-20-0.9-EZ-L
27 mm	EZ	1	3857-27-0.9-EZ-S
27 mm	EZ	1	3857-27-0.9-EZ-M
27 mm	EZ	1	3857-27-0.9-EZ-L
34 mm	EZ	1	3857-34-1.1-EZ-S
34 mm	EZ	1	3857-34-1.1-EZ-M
34 mm	EZ	1	3857-34-1.1-EZ-L

Bandsågblad i bimetall för kontursågning och för små maskiner

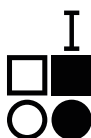

3851 Contour and small machine

6 mm	PRX	1	3851-6-0.6-10/14
6 mm	Hook	1	3851-6-0.6-H-6
6 mm	PRX	1	3851-6-0.9-10/14
6 mm	Hook	1	3851-6-0.9-H-6
10 mm	PRX	1	3851-10-0.6-10/14
10 mm	Hook	1	3851-10-0.6-H-4
10 mm	Hook	1	3851-10-0.6-H-6
10 mm	PRX	1	3851-10-0.9-10/14
10 mm	Hook	1	3851-10-0.9-H-4
10 mm	Hook	1	3851-10-0.9-H-6
10 mm	Regular	1	3851-10-0.9-R-14
13 mm	PRX	1	3851-13-0.5-10/14

13 mm	PRX	1	3851-13-0.5-14/18
13 mm	Regular	1	3851-13-0.5-R-10
13 mm	Regular	1	3851-13-0.5-R-14
13 mm	Regular	1	3851-13-0.5-R-18
13 mm	Regular	1	3851-13-0.5-R-24
13 mm	Hook	1	3851-13-0.5-H-4
13 mm	PRX	1	3851-13-0.6-10/14
13 mm	PRX	1	3851-13-0.6-5/8
13 mm	PRX	1	3851-13-0.6-6/10
13 mm	PRX	1	3851-13-0.6-8/12
13 mm	Hook	1	3851-13-0.6-H-3
13 mm	Hook	1	3851-13-0.6-H-4
13 mm	Hook	1	3851-13-0.6-H-6
13 mm	Regular	1	3851-13-0.6-R-10
13 mm	Regular	1	3851-13-0.6-R-14
13 mm	Regular	1	3851-13-0.6-R-18
13 mm	PRX	1	3851-13-0.9-10/14
13 mm	PRX	1	3851-13-0.9-6/10
13 mm	Hook	1	3851-13-0.9-H-3
13 mm	Hook	1	3851-13-0.9-H-4
13 mm	Hook	1	3851-13-0.9-H-6
13 mm	Regular	1	3851-13-0.9-R-14
13 mm	Regular	1	3851-13-0.9-R-6
20 mm	PRX	1	3851-20-0.9-10/14
20 mm	Hook	1	3851-20-0.9-H-3
20 mm	Hook	1	3851-20-0.9-H-4
20 mm	Regular	1	3851-20-0.9-R-18
20 mm	PRX	1	3851-20-0.9-4/6
20 mm	PRX	1	3851-20-0.9-5/8
20 mm	PRX	1	3851-20-0.9-6/10
20 mm	PRX	1	3851-20-0.9-8/12
27 mm	PS	1	3851-27-0.9-P-3
27 mm	PS	1	3851-27-0.9-P-4
27 mm	Regular	1	3851-27-0.9-R-6
34 mm	PS	1	3851-34-1.1-P-2
34 mm	PS	1	3851-34-1.1-P-3

Bandsågblad för gjutgods

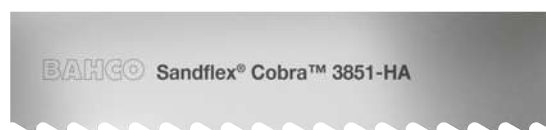

3851 Sandflex® Cobra™ Foundry

10 mm	HA	1	3851-10-0.6-HA-4
13 mm	HA	1	3851-13-0.6-HA-4
13 mm	HA	1	3851-13-0.6-HA-6
13 mm	HA	1	3851-13-0.9-HA-4
20 mm	HA	1	3851-20-0.9-HA-3
20 mm	HA	1	3851-20-0.9-HA-4
27 mm	HA	1	3851-27-0.9-HA-4
27 mm	HA	1	3851-27-0.9-HA-3

Mångsidigt bandsågblad, ett förstahandsval för produktionssågning.



3851 Sandflex® Cobra™



Bladdjup	Profil	Material	Antal	Modell
27 mm	PRX	1	3851-27-0.9-2/3	
27 mm	PRX	1	3851-27-0.9-3/4	
27 mm	PRX	1	3851-27-0.9-4/6	
27 mm	PRX	1	3851-27-0.9-5/8	
27 mm	PRX	1	3851-27-0.9-6/10	
27 mm	PRX	1	3851-27-0.9-8/12	
27 mm	PRX	1	3851-27-0.9-10/14	
34 mm	PRX	1	3851-34-1.1-2/3	
34 mm	PRX	1	3851-34-1.1-3/4	
34 mm	PRX	1	3851-34-1.1-4/6	
34 mm	PRX	1	3851-34-1.1-5/8	
34 mm	PRX	1	3851-34-1.1-6/10	
41 mm	PRX	1	3851-41-1.3-1.4/2	
41 mm	PRX	1	3851-41-1.3-2/3	
41 mm	PRX	1	3851-41-1.3-3/4	
41 mm	PRX	1	3851-41-1.3-4/6	
41 mm	PRX	1	3851-41-1.3-5/8	
54 mm	PRX	1	3851-54-1.3-1.4/2	
54 mm	PRX	1	3851-54-1.3-2/3	
54 mm	PRX	1	3851-54-1.3-4/6	
54 mm	PR	1	3851-54-1.6-P-1.25	
54 mm	PRX	1	3851-54-1.6-1/1.4	
54 mm	PRX	1	3851-54-1.6-1.4/2	
54 mm	PRX	1	3851-54-1.6-2/3	
54 mm	PRX	1	3851-54-1.6-3/4	
54 mm	PRX	1	3851-54-1.6-4/6	
67 mm	PRX	1	3851-67-1.6-7/1	
67 mm	PRX	1	3851-67-1.6-1/1.4	
67 mm	PRX	1	3851-67-1.6-1.4/2	
67 mm	PRX	1	3851-67-1.6-2/3	
67 mm	PRX	1	3851-67-1.6-3/4	
67 mm	PRX	1	3851-67-1.6-4/6	
80 mm	PRX	1	3851-80-1.6-7/1	
80 mm	PRX	1	3851-80-1.6-1/1.4	
80 mm	PRX	1	3851-80-1.6-1.4/2	

Unikt utformat bandsågblad för verktygsstål och hårdare material



3854-Sandflex® King Cobra™ PHX



Bladdjup	Profil	Material	Antal	Modell
27 mm	PHX	1	3854-27-0.9-PHX-2/3	
27 mm	PHX	1	3854-27-0.9-PHX-3/4	
27 mm	PHX	1	3854-27-0.9-PHX-4/6	
34 mm	PHX	1	3854-34-1.1-PHX-1.4/2	

Bladdjup	Profil	Material	Antal	Modell
34 mm	PHX	1	3854-34-1.1-PHX-2/3	
34 mm	PHX	1	3854-34-1.1-PHX-3/4	
34 mm	PHX	1	3854-34-1.1-PHX-4/6	
41 mm	PHX	1	3854-41-1.3-PHX-1.4/2	
41 mm	PHX	1	3854-41-1.3-PHX-2/3	
41 mm	PHX	1	3854-41-1.3-PHX-3/4	
41 mm	PHX	1	3854-41-1.3-PHX-4/6	
54 mm	PHX	1	3854-54-1.3-PHX-1.4/2	
54 mm	PHX	1	3854-54-1.3-PHX-2/3	
54 mm	PHX	1	3854-54-1.3-PHX-3/4	
54 mm	PHX	1	3854-54-1.6-PHX-7/1	
54 mm	PHX	1	3854-54-1.6-PHX-1/1.4	
54 mm	PHX	1	3854-54-1.6-PHX-1.4/2	
54 mm	PHX	1	3854-54-1.6-PHX-2/3	
54 mm	PHX	1	3854-54-1.6-PHX-3/4	
67 mm	PHX	1	3854-67-1.6-PHX-7/1	
67 mm	PHX	1	3854-67-1.6-PHX-1/1.4	
67 mm	PHX	1	3854-67-1.6-PHX-1.4/2	
67 mm	PHX	1	3854-67-1.6-PHX-2/3	
80 mm	PHX	1	3854-80-1.6-PHX-7/1	
80 mm	PHX	1	3854-80-1.6-PHX-1/1.4	
80 mm	PHX	1	3854-80-1.6-PHX-1.4/2	

Effektivt bandsågblad för rostfritt stål och andra hårda material



3854-Sandflex® King Cobra™ PQ



Bladdjup	Profil	Material	Antal	Modell
27 mm	PQ	1	3854-27-0.9-PQ-3/4	
27 mm	PQ	1	3854-27-0.9-PQ-4/6	
34 mm	PQ	1	3854-34-1.1-PQ-2/3	
34 mm	PQ	1	3854-34-1.1-PQ-3/4	
34 mm	PQ	1	3854-34-1.1-PQ-4/6	
41 mm	PQ	1	3854-41-1.3-PQ-1.4/2	
41 mm	PQ	1	3854-41-1.3-PQ-2/3	
41 mm	PQ	1	3854-41-1.3-PQ-3/4	
41 mm	PQ	1	3854-41-1.3-PQ-4/6	
54 mm	PQ	1	3854-54-1.6-PQ-9/1.2	
54 mm	PQ	1	3854-54-1.6-PQ-1.4/2	
54 mm	PQ	1	3854-54-1.6-PQ-2/3	
54 mm	PQ	1	3854-54-1.6-PQ-3/4	
54 mm	PQ	1	3854-54-1.6-PQ-4/6	
67 mm	PQ	1	3854-67-1.6-PQ-9/1.2	
67 mm	PQ	1	3854-67-1.6-PQ-1.4/2	
67 mm	PQ	1	3854-67-1.6-PQ-2/3	
80 mm	PQ	1	3854-80-1.6-PQ-9/1.2	
80 mm	PQ	1	3854-80-1.6-PQ-1.4/2	



Effektivt bandsågblad med lång livslängd, för rostfritt stål och hårda material



3858 PQ P9000

Bladdjup	Profil	Antal	Modell
41 mm	PQ	1	3858-41-1.3-PQ-1.4/2
41 mm	PQ	1	3858-41-1.3-PQ-2/3
41 mm	PQ	1	3858-41-1.3-PQ-3/4
54 mm	PQ	1	3858-54-1.6-PQ-9/1.2
54 mm	PQ	1	3858-54-1.6-PQ-1.4/2
54 mm	PQ	1	3858-54-1.6-PQ-2/3
67 mm	PQ	1	3858-67-1.6-PQ-9/1.2
67 mm	PQ	1	3858-67-1.6-PQ-1.4/2
80 mm	PQ	1	3858-80-1.6-PQ-9/1.2

Unikt utformat bandsågblad med lång livslängd, för verktygsstål och hårdare material

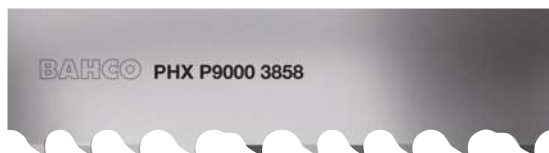

3858 PHX P9000

Bladdjup	Profil	Antal	Modell
34 mm	PHX	1	3858-34-1.1-PHX-1.4/2
34 mm	PHX	1	3858-34-1.1-PHX-2/3
34 mm	PHX	1	3858-34-1.1-PHX-3/4
41 mm	PHX	1	3858-41-1.3-PHX-1.4/2
41 mm	PHX	1	3858-41-1.3-PHX-2/3
41 mm	PHX	1	3858-41-1.3-PHX-3/4
54 mm	PHX	1	3858-54-1.3-PHX-1.4/2
54 mm	PHX	1	3858-54-1.3-PHX-2/3
54 mm	PHX	1	3858-54-1.3-PHX-3/4
54 mm	PHX	1	3858-54-1.6-PHX-7/1
54 mm	PHX	1	3858-54-1.6-PHX-1/1.4
54 mm	PHX	1	3858-54-1.6-PHX-1.4/2
54 mm	PHX	1	3858-54-1.6-PHX-2/3
54 mm	PHX	1	3858-54-1.6-PHX-3/4
67 mm	PHX	1	3858-67-1.6-PHX-7/1
67 mm	PHX	1	3858-67-1.6-PHX-1/1.4
67 mm	PHX	1	3858-67-1.6-PHX-1.4/2
67 mm	PHX	1	3858-67-1.6-PHX-2/3
80 mm	PHX	1	3858-80-1.6-PHX-7/1
80 mm	PHX	1	3858-80-1.6-PHX-1/1.4
80 mm	PHX	1	3858-80-1.6-PHX-1.4/2

Specialkonstruerat bandsågblad för profiler, rör och buntar



3853 Sandflex® Top Fabricator

Bladdjup	Profil	Antal	Modell
20 mm	PF	1	3853-20-0.9-5/7-VS
20 mm	PF	1	3853-20-0.9-8/11-VS
27 mm	PF	1	3853-27-0.9-3/4
27 mm	PF	1	3853-27-0.9-4/6
27 mm	PF	1	3853-27-0.9-5/8
27 mm	PF	1	3853-27-0.9-5/7-VS
27 mm	PF	1	3853-27-0.9-8/11-VS
34 mm	PF	1	3853-34-1.1-2/3
34 mm	PF	1	3853-34-1.1-3/4
34 mm	PF	1	3853-34-1.1-4/6
34 mm	PF	1	3853-34-1.1-5/8
34 mm	PF	1	3853-34-1.1-5/7-VS
34 mm	PF	1	3853-34-1.1-8/11-VS
41 mm	PF	1	3853-41-1.3-2/3
41 mm	PF-W	1	3853-41-1.3-2/3-W
41 mm	PF	1	3853-41-1.3-3/4
41 mm	PF-W	1	3853-41-1.3-3/4-W
41 mm	PF	1	3853-41-1.3-4/6
41 mm	PF	1	3853-41-1.3-5/8
41 mm	PF	1	3853-41-1.3-5/7-VS
54 mm	PF	1	3853-54-1.3-3/4
54 mm	PF	1	3853-54-1.3-3/4-W
54 mm	PF	1	3853-54-1.3-5/8
54 mm	PF	1	3853-54-1.6-2/3
54 mm	PF-W	1	3853-54-1.6-2/3-W
54 mm	PF	1	3853-54-1.6-3/4
54 mm	PF-W	1	3853-54-1.6-3/4-W
54 mm	PF	1	3853-54-1.6-4/6
67 mm	PF	1	3853-67-1.6-2/3
67 mm	PF-W	1	3853-67-1.6-2/3-W
67 mm	PF	1	3853-67-1.6-3/4
67 mm	PF-W	1	3853-67-1.6-3/4-W
67 mm	PF-W	1	3853-67-1.6-5/8-W

Bandsågsblad i bimetal^{all} för produktionskapning av stora och svårsågade speciallegeringar, med snabbstälstandning



3853 Sandflex® Top Fabricator Coated

Bladdjup	Profil	Antal	Modell
41 mm	PF	1	3853-41-1.3-2/3-WS
41 mm	PF	1	3853-41-1.3-3/4-WS
54 mm	PF	1	3853-54-1.6-2/3-WS
54 mm	PF	1	3853-54-1.6-3/4-WS
67 mm	PF	1	3853-67-1.6-2/3-WS
67 mm	PF	1	3853-67-1.6-3/4-WS

BANDSÅGBLAD AV HÅRDMETALL FÖR METALLKAPNING

Extreme Easy-Cut bandsågblad i hårdmetall



BAHCO Easy-Cut Xtreme TriMetal 3859

3859 Carbide EasyCut EZX

27 mm	EZX	1	3859-27-0.9-EZX-3/4
27 mm	EZX	1	3859-27-0.9-EZX-4/6
34 mm	EZX	1	3859-34-1.1-EZX-2/3
34 mm	EZX	1	3859-34-1.1-EZX-3/4
34 mm	EZX	1	3859-34-1.1-EZX-4/6
41 mm	EZX	1	3859-41-1.3-EZX-1.4/2
41 mm	EZX	1	3859-41-1.3-EZX-2/3
41 mm	EZX	1	3859-41-1.3-EZX-3/4
41 mm	EZX	1	3859-41-1.3-EZX-4/6
54 mm	EZX	1	3859-54-1.6-EZX-1.4/2
54 mm	EZX	1	3859-54-1.6-EZX-1/1.25
54 mm	EZX	1	3859-54-1.6-EZX-2/3
54 mm	EZX	1	3859-54-1.6-EZX-3/4
54 mm	EZX	1	3859-54-1.6-EZX-4/6
67 mm	EZX	1	3859-67-1.6-EZX-7/1
67 mm	EZX	1	3859-67-1.6-EZX-1.4/2
67 mm	EZX	1	3859-67-1.6-EZX-1/1.25
67 mm	EZX	1	3859-67-1.6-EZX-2/3
80 mm	EZX	1	3859-80-1.6-EZX-7/1
80 mm	EZX	1	3859-80-1.6-EZX-1.4/2
80 mm	EZX	1	3859-80-1.6-EZX-1/1.25

Bandsågblad för gjutgods



BAHCO Carbide Triple Set® 3869

3869 Carbide Triple Set®

13 mm	TS	1	3869-13-0.9-TS-3
20 mm	TS	1	3869-20-0.9-TS-3
20 mm	TS	1	3869-20-0.9-TS-4
27 mm	TS	1	3869-27-0.9-TS-3
27 mm	TS	1	3869-27-0.9-TS-4
34 mm	TS	1	3869-34-1.1-TS-2
34 mm	TS	1	3869-34-1.1-TS-3

Mångsidigt bandsågblad i hårdmetall



BAHCO Carbide Triple Set® TSX 3868

3868 Carbide Triple Set® TSX

27 mm	TSX	1	3868-27-0.9-TSX-3/4
34 mm	TSX	1	3868-34-1.1-TSX-2
34 mm	TSX	1	3868-34-1.1-TSX-2/3
34 mm	TSX	1	3868-34-1.1-TSX-3/4
41 mm	TSX	1	3868-41-1.3-TSX-1.4/2
41 mm	TSX	1	3868-41-1.3-TSX-1.6
41 mm	TSX	1	3868-41-1.3-TSX-2
41 mm	TSX	1	3868-41-1.3-TSX-2/3
41 mm	TSX	1	3868-41-1.3-TSX-3/4
54 mm	TSX	1	3868-54-1.3-TSX-1.4/2
54 mm	TSX	1	3868-54-1.3-TSX-2/3
54 mm	TSX	1	3868-54-1.6-TSX-1/1.25
54 mm	TSX	1	3868-54-1.6-TSX-1.4/2
54 mm	TSX	1	3868-54-1.6-TSX-1.6
54 mm	TSX	1	3868-54-1.6-TSX-2/3
54 mm	TSX	1	3868-54-1.6-TSX-3/4
67 mm	TSX	1	3868-67-1.6-TSX-7/1
67 mm	TSX	1	3868-67-1.6-TSX-1/1.25
67 mm	TSX	1	3868-67-1.6-TSX-1.4/2
67 mm	TSX	1	3868-67-1.6-TSX-2/3
80 mm	TSX	1	3868-80-1.1-TSX-3/4
80 mm	TSX	1	3868-80-1.6-TSX-7/1
80 mm	TSX	1	3868-80-1.6-TSX-1/1.25
80 mm	TSX	1	3868-80-1.6-TSX-1.4/2
80 mm	TSX	1	3868-80-1.6-TSX-2/3

Mångsidigt skärpt bandsågblad i hårdmetall



BAHCO Carbide Triple Set® TSS 3868

3868 Carbide Triple Set® TSS

27 mm	TSS	1	3868-27-0.9-TSS-3/4
34 mm	TSS	1	3868-34-1.1-TSS-2/3
41 mm	TSS	1	3868-41-1.3-TSS-1.4/2
41 mm	TSS	1	3868-41-1.3-TSS-2/3
54 mm	TSS	1	3868-54-1.6-TSS-1/1.25
54 mm	TSS	1	3868-54-1.6-TSS-1.4/2
54 mm	TSS	1	3868-54-1.6-TSS-2/3
67 mm	TSS	1	3868-67-1.6-TSS-7/1
67 mm	TSS	1	3868-67-1.6-TSS-1/1.25
67 mm	TSS	1	3868-67-1.6-TSS-1.4/2
67 mm	TSS	1	3868-67-1.6-TSS-2/3
67 mm	TSS	1	3868-67-1.6-TSS-3/4
80 mm	TSS	1	3868-80-1.6-TSS-7/1
80 mm	TSS	1	3868-80-1.6-TSS-1.4/2
80 mm	TSS	1	3868-80-1.6-TSS-2/3



Avancerat bandsågblad i hårdmetall



3881 Carbide Multi Set THQ

Bladbredd	Skärhög	Material	Antal	Modell
34 mm	THQ	TMC	1	3881-34-1.1-THQ-2/3
41 mm	THQ	TMC	1	3881-41-1.3-THQ-1.4/2
41 mm	THQ	TMC	1	3881-41-1.3-THQ-2/3
54 mm	THQ	TMC	1	3881-54-1.6-THQ-1.4/2
54 mm	THQ	TMC	1	3881-54-1.6-THQ-1/1.25
54 mm	THQ	TMC	1	3881-54-1.6-THQ-2/3
67 mm	THQ	TMC	1	3881-67-1.6-THQ-1/1.25
67 mm	THQ	TMC	1	3881-67-1.6-THQ-1.4/2
67 mm	THQ	TMC	1	3881-67-1.6-THQ-2/3
80 mm	THQ	TMC	1	3881-80-1.6-THQ-7/1
80 mm	THQ	TMC	1	3881-80-1.6-THQ-1/1.25
80 mm	THQ	TMC	1	3881-80-1.6-THQ-1.4/2
80 mm	THQ	TMC	1	3881-80-1.6-THQ-2/3

Avancerat skärpt bandsågblad i hårdmetall



3881 Carbide Multi Set THS

Bladbredd	Skärhög	Material	Antal	Modell
41 mm	THS	TMC	1	3881-41-1.3-THS-1.4/2
54 mm	THS	TMC	1	3881-54-1.6-THS-1/1.25
54 mm	THS	TMC	1	3881-54-1.6-THS-1.4/2
67 mm	THS	TMC	1	3881-67-1.6-THS-1/1.25
67 mm	THS	TMC	1	3881-67-1.6-THS-1.4/2
67 mm	THS	TMC	1	3881-67-1.6-THS-2/3
80 mm	THS	TMC	1	3881-80-1.6-THS-7/1
80 mm	THS	TMC	1	3881-80-1.6-THS-1.4/2
80 mm	THS	TMC	1	3881-80-1.6-THS-2/3
100 mm	THS	TMC	1	3881-100-1.6-THS-7/1

Det mest avancerade bandsågbladet i hårdmetall



3860 Unset Carbide TMC

Bladbredd	Skärhög	Material	Antal	Modell
41 mm	TMC	TMC	1	3860-41-1.3-TMC-1.4/2
41 mm	TMC	TMC	1	3860-41-1.3-TMC-2/3
54 mm	TMC	TMC	1	3860-54-1.3-TMC-1.4/2

BAHCO

Bladbredd	Skärhög	Material	Antal	Modell
54 mm	TMC	TMC	1	3860-54-1.3-TMC-2/3
54 mm	TMC	TMC	1	3860-54-1.6-TMC-7/1
54 mm	TMC	TMC	1	3860-54-1.6-TMC-1/1.25
54 mm	TMC	TMC	1	3860-54-1.6-TMC-1.4/2
54 mm	TMC	TMC	1	3860-54-1.6-TMC-2/3
67 mm	TMC	TMC	1	3860-67-1.6-TMC-1/1.25
67 mm	TMC	TMC	1	3860-67-1.6-TMC-1.4/2
67 mm	TMC	TMC	1	3860-67-1.6-TMC-2/3
80 mm	TMC	TMC	1	3860-80-1.1-TMC-1.4/2
80 mm	TMC	TMC	1	3860-80-1.6-TMC-7/1
80 mm	TMC	TMC	1	3860-80-1.6-TMC-1/1.25
80 mm	TMC	TMC	1	3860-80-1.6-TMC-1.4/2
80 mm	TMC	TMC	1	3860-80-1.6-TMC-2/3
100 mm	TMC	TMC	1	3860-100-1.1-TMC-1.4/2

Mångsidigt bandsågblad i hårdmetall



3860 Unset Carbide TCD

Bladbredd	Skärhög	Material	Antal	Modell
27 mm	TCD	TCD	1	3860-27-0.9-TCD-3
27 mm	TCD	TCD	1	3860-27-0.9-TCD-3/4
34 mm	TCD	TCD	1	3860-34-1.1-TCD-2/3
34 mm	TCD	TCD	1	3860-34-1.1-TCD-3/4
34 mm	TCD	TCD	1	3860-34-1.1-TCD-3/4-W
41 mm	TCD	TCD	1	3860-41-1.3-TCD-1.4/2
41 mm	TCD	TCD	1	3860-41-1.3-TCD-1.9/2.1
41 mm	TCD	TCD	1	3860-41-1.3-TCD-2/3
41 mm	TCD	TCD	1	3860-41-1.3-TCD-3/4
54 mm	TCD	TCD	1	3860-54-1.6-TCD-1.4/2
54 mm	TCD	TCD	1	3860-54-1.6-TCD-1.9/2.1
54 mm	TCD	TCD	1	3860-54-1.6-TCD-2/3
54 mm	TCD	TCD	1	3860-54-1.6-TCD-3/4
67 mm	TCD	TCD	1	3860-67-1.6-TCD-1.4/2
67 mm	TCD	TCD	1	3860-67-1.6-TCD-1/1.25
80 mm	TCD	TCD	1	3860-80-1.6-TCD-5/0.8

Bandsågblad för induktionshärdade stänger



3860 Unset Carbide TCZ

Bladbredd	Skärhög	Material	Antal	Modell
27 mm	TCZ	TCZ	1	3860-27-0.9-TCZ-3/4
34 mm	TCZ	TCZ	1	3860-34-1.1-TCZ-2/3
34 mm	TCZ	TCZ	1	3860-34-1.1-TCZ-3/4
41 mm	TCZ	TCZ	1	3860-41-1.3-TCZ-2/3
41 mm	TCZ	TCZ	1	3860-41-1.3-TCZ-3/4

Oskränkt hårdmetallband TMC. För svårkapade och nötande material



3860 Unset Carbide TMC Coated



Ø	Profile	Icons	Part No.
54 mm	TMC		1 3860-54-1.6-TMC-1/1.25S
54 mm	TMC		1 3860-54-1.6-TMC-1.4/2S
54 mm	TMC		1 3860-54-1.6-TMC-2/3S
67 mm	TMC		1 3860-67-1.6-TMC-1/1.25S
67 mm	TMC		1 3860-67-1.6-TMC-1.4/2S

HSS KAPKLINGOR

Kapklinga i snabbstål med 32-1-centrumhål



3815-32-1

Ø	Profile	Icons	Part No.
200 mm	BW3		1 3815-200-2.0-32-1-03BW
200 mm	BW4		1 3815-200-2.0-32-1-04BW
225 mm	BW3		1 3815-225-2.0-32-1-03BW
225 mm	BW4		1 3815-225-2.0-32-1-04BW
225 mm	BW5		1 3815-225-2.0-32-1-05BW
225 mm	C6		1 3815-225-2.0-32-1-06C
250 mm	BW3		1 3815-250-2.0-32-1-03BW
250 mm	BW4		1 3815-250-2.0-32-1-04BW
250 mm	BW5		1 3815-250-2.0-32-1-05BW
250 mm	C6		1 3815-250-2.0-32-1-06C
275 mm	BW4		1 3815-275-2.5-32-1-04BW
275 mm	BW5		1 3815-275-2.5-32-1-05BW
275 mm	C6		1 3815-275-2.5-32-1-06C
275 mm	C8		1 3815-275-2.5-32-1-08C
300 mm	BW4		1 3815-300-2.5-32-1-04BW
300 mm	BW5		1 3815-300-2.5-32-1-05BW
300 mm	C5		1 3815-300-2.5-32-1-05C
300 mm	C6		1 3815-300-2.5-32-1-06C
300 mm	C8		1 3815-300-2.5-32-1-08C
315 mm	BW4		1 3815-315-2.5-32-1-04BW
315 mm	BW5		1 3815-315-2.5-32-1-05BW
315 mm	C6		1 3815-315-2.5-32-1-06C

Ø	Profile	Icons	Part No.
315 mm	C8		1 3815-315-2.5-32-1-08C
350 mm	BW4		1 3815-350-2.5-32-1-04BW
350 mm	C6		1 3815-350-2.5-32-1-06C

Kapklinga i snabbstål med 40-2-centrumhål



3815-40-2

Ø	Profile	Icons	Part No.
250 mm	BW3		1 3815-250-2.0-40-2-03BW
250 mm	BW4		1 3815-250-2.0-40-2-04BW
250 mm	BW5		1 3815-250-2.0-40-2-05BW
275 mm	BW3		1 3815-275-2.5-40-2-03BW
275 mm	BW4		1 3815-275-2.5-40-2-04BW
275 mm	BW5		1 3815-275-2.5-40-2-05BW
275 mm	C6		1 3815-275-2.5-40-2-06C
275 mm	C8		1 3815-275-2.5-40-2-08C
315 mm	BW4		1 3815-315-2.5-40-2-04BW
315 mm	BW5		1 3815-315-2.5-40-2-05BW
315 mm	C6		1 3815-315-3.0-40-2-06C

Kapklinga i snabbstål med 50-4-centrumhål



3815-50-4

Ø	Profile	Icons	Part No.
370 mm	C8		1 3815-370-3.0-50-4-08C
370 mm	C10		1 3815-370-3.0-50-4-10C
400 mm	C10		1 3815-400-3.5-50-4-10C



TRÄKAPNING

Bandsågblad av bimetall för längre livslängd



3861 Sandcut Bi-metal

Tecken	Profil	Tecken	Tecken
4	Hook	1	3861-20-0.6-H-4
1.33	Hook	1	3861-27-0.9-H-1.33
1.15	Hook	1	3861-34-0.9-H-1.15
1.15	Hook	1	3861-34-1.1-H-1.15
1.15	Hook	1	3861-41-1.1-H-1.15
1.15	Hook	1	3861-54-1.1-H-1.15

Standardbandsågblad

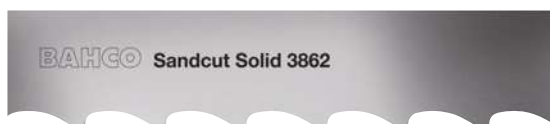

3862 Sandcut Solid

Tecken	Profil	Tecken	Tecken
1.15	Hook	1	3862-33-0.9-H-1.15
1.15	Hook	1	3862-33-1.1-H-1.15
1.15	Hook	1	3862-40-1.1-H-1.15

TILLBEHÖR TILL BANDSÅGNING

Spånborste för rengöring av bandsågsblad



3870-BRUSH

Tecken	Tecken	Tecken
60 mm	4	3870-BRUSH-60-6
80 mm	4	3870-BRUSH-80-6
80 mm	4	3870-BRUSH-80-8
80 mm	4	3870-BRUSH-80-10
100 mm	4	3870-BRUSH-100-10



100 mm
100 mm
100 mm



4 3870-BRUSH-100-12
4 3870-BRUSH-100-10-HEX
1 3870-BRUSH-100-13

Takometer för bandsåg



3870-TACHO

Tecken	Tecken	Tecken
400 g	1	3870-TACHO METER

Tensiometer, bladspänningsmätare för bandsåg



3870-TENSION

Tecken	Tecken	Tecken
680 g	1	3870-TENSION METER

Refraktometer för bandsåg



3870-REFR

Tecken	Tecken	Tecken
260 g	1	3870-REFRACTOMETER

Stålkilar, 75 mm



3870-WEDGE



60 g



1 3870-WEDGE-3

Hjul för justering av bandspänning



3870-Wheel



0.7790 kg



1 3870-WHEEL

MASKINSÅGBLAD

Sandflex® maskinsågblad i bimetall



3809



	L		
10	300 mm	10	3809-300-25-1.25-10
14	300 mm	10	3809-300-25-1.25-14
6	300 mm	10	3809-300-32-1.60-6
10	300 mm	10	3809-300-32-1.60-10
6	350 mm	10	3809-350-25-1.25-6
10	350 mm	10	3809-350-25-1.25-10
14	350 mm	10	3809-350-25-1.25-14
4	350 mm	10	3809-350-32-1.60-4



	L		
6	350 mm	10	3809-350-32-1.60-6
8	350 mm	10	3809-350-32-1.60-8
10	350 mm	10	3809-350-32-1.60-10
14	350 mm	10	3809-350-32-1.60-14
4	350 mm	10	3809-350-32-2.00-4
6	350 mm	10	3809-350-32-2.00-6
10	350 mm	10	3809-350-32-2.00-10
6	350 mm	10	3809-350-38-2.00-6
10	350 mm	10	3809-350-38-2.00-10
10	400 mm	10	3809-400-25-1.25-10
4	400 mm	10	3809-400-32-1.60-4
6	400 mm	10	3809-400-32-1.60-6
8	400 mm	10	3809-400-32-1.60-8
10	400 mm	10	3809-400-32-1.60-10
14	400 mm	10	3809-400-32-1.60-14
4	400 mm	10	3809-400-32-2.00-4
6	400 mm	10	3809-400-32-2.00-6
8	400 mm	10	3809-400-32-2.00-8
10	400 mm	10	3809-400-32-2.00-10
4	400 mm	10	3809-400-38-2.00-4
6	400 mm	10	3809-400-38-2.00-6
10	400 mm	10	3809-400-38-2.00-10
6	425 mm	10	3809-425-32-1.60-6
10	425 mm	10	3809-425-32-1.60-10
4	450 mm	10	3809-450-32-1.60-4
6	450 mm	10	3809-450-32-1.60-6
10	450 mm	10	3809-450-32-1.60-10
14	450 mm	10	3809-450-32-1.60-14
4	450 mm	10	3809-450-32-2.00-4
6	450 mm	10	3809-450-32-2.00-6
10	450 mm	10	3809-450-32-2.00-10
4	450 mm	10	3809-450-38-2.00-4
6	450 mm	10	3809-450-38-2.00-6
8	450 mm	10	3809-450-38-2.00-8
10	450 mm	10	3809-450-38-2.00-10
4	450 mm	10	3809-450-45-2.25-4
6	450 mm	10	3809-450-45-2.25-6
6	475 mm	10	3809-475-45-2.25-6
4	500 mm	10	3809-500-38-2.00-4
6	500 mm	10	3809-500-38-2.00-6
10	500 mm	10	3809-500-38-2.00-10
4	500 mm	10	3809-500-45-2.25-4
6	500 mm	10	3809-500-45-2.25-6
4	500 mm	10	3809-500-50-2.50-4
6	500 mm	10	3809-500-50-2.50-6
8	500 mm	10	3809-500-50-2.50-8
6	525 mm	10	3809-525-38-2.00-6
10	525 mm	10	3809-525-38-2.00-10
4	525 mm	10	3809-525-45-2.25-4
6	525 mm	10	3809-525-45-2.25-6
4	550 mm	10	3809-550-45-2.25-4
6	550 mm	10	3809-550-45-2.25-6
4	550 mm	10	3809-550-50-2.50-4
6	550 mm	10	3809-550-50-2.50-6
4	575 mm	10	3809-575-45-2.25-4
3	575 mm	10	3809-575-50-2.50-3
4	575 mm	10	3809-575-50-2.50-4
6	575 mm	10	3809-575-50-2.50-6
6	600 mm	10	3809-600-38-2.00-6
4	600 mm	10	3809-600-45-2.25-4
6	600 mm	10	3809-600-45-2.25-6
3	600 mm	10	3809-600-50-2.50-3
4	600 mm	10	3809-600-50-2.50-4
6	600 mm	10	3809-600-50-2.50-6
4	650 mm	5	3809-650-50-2.50-4
6	650 mm	5	3809-650-50-2.50-6
4	700 mm	5	3809-700-50-2.50-4
6	700 mm	5	3809-700-50-2.50-6
4	750 mm	5	3809-750-50-2.50-4
6	750 mm	5	3809-750-50-2.50-6



Sandflex® maskinsågblad i bimettall för KASTO-maskiner





3809 KA

			
6	400 mm	10	3809-400-32-2.00-6-KA
4	450 mm	10	3809-450-38-2.00-4-KA
6	450 mm	10	3809-450-38-2.00-6-KA
10	450 mm	10	3809-450-38-2.00-10-KA
6	500 mm	10	3809-500-45-2.25-6-KA
4	500 mm	10	3809-500-50-2.50-4-KA
6	500 mm	10	3809-500-50-2.50-6-KA
4	550 mm	10	3809-550-50-2.50-4-KA
6	550 mm	10	3809-550-50-2.50-6-KA
3	575 mm	10	3809-575-50-2.50-3-KA
4	575 mm	10	3809-575-50-2.50-4-KA
6	575 mm	10	3809-575-50-2.50-6-KA
10	575 mm	10	3809-575-50-2.50-10-KA
4	600 mm	10	3809-600-50-2.50-4-KA
6	600 mm	10	3809-600-50-2.50-6-KA
3	650 mm	5	3809-650-50-2.50-3-KA
4	650 mm	5	3809-650-50-2.50-4-KA
6	650 mm	5	3809-650-50-2.50-6-KA
3	700 mm	5	3809-700-50-2.50-3-KA
4	700 mm	5	3809-700-50-2.50-4-KA
6	700 mm	5	3809-700-50-2.50-6-KA

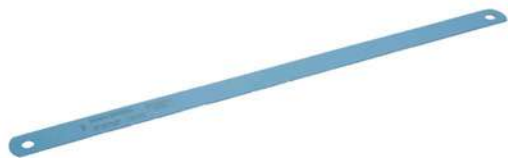

Maskinsågblad i HSS



3802

			
6	300 mm	10	3802-300-25-1.25-6
10	300 mm	10	3802-300-25-1.25-10
14	300 mm	10	3802-300-25-1.25-14
6	300 mm	10	3802-300-32-1.60-6
10	300 mm	10	3802-300-32-1.60-10
6	350 mm	10	3802-350-25-1.25-6
10	350 mm	10	3802-350-25-1.25-10
14	350 mm	10	3802-350-25-1.25-14
4	350 mm	10	3802-350-32-1.60-4
6	350 mm	10	3802-350-32-1.60-6
8	350 mm	10	3802-350-32-1.60-8
10	350 mm	10	3802-350-32-1.60-10
14	350 mm	10	3802-350-32-1.60-14
6	400 mm	10	3802-400-25-1.25-6
10	400 mm	10	3802-400-25-1.25-10
14	400 mm	10	3802-400-25-1.25-14
4	400 mm	10	3802-400-32-1.60-4
6	400 mm	10	3802-400-32-1.60-6
8	400 mm	10	3802-400-32-1.60-8
10	400 mm	10	3802-400-32-1.60-10
14	400 mm	10	3802-400-32-1.60-14
4	400 mm	10	3802-400-38-2.00-4
6	400 mm	10	3802-400-38-2.00-6
10	400 mm	10	3802-400-38-2.00-10
6	425 mm	10	3802-425-32-1.60-6



BAHCO

			
10	425 mm	10	3802-425-32-1.60-10
4	450 mm	10	3802-450-32-1.60-4
6	450 mm	10	3802-450-32-1.60-6
10	450 mm	10	3802-450-32-1.60-10
14	450 mm	10	3802-450-32-1.60-14
4	450 mm	10	3802-450-38-2.00-4
6	450 mm	10	3802-450-38-2.00-6
8	450 mm	10	3802-450-38-2.00-8
10	450 mm	10	3802-450-38-2.00-10
8	475 mm	10	3802-475-38-2.00-8
4	500 mm	10	3802-500-38-2.00-4
6	500 mm	10	3802-500-38-2.00-6
8	500 mm	10	3802-500-38-2.00-8
10	500 mm	10	3802-500-38-2.00-10
10	500 mm	10	3802-500-45-2.25-10
4	500 mm	10	3802-500-50-2.50-4
6	500 mm	10	3802-500-50-2.50-6
6	525 mm	10	3802-525-38-2.00-6
8	525 mm	10	3802-525-38-2.00-8
10	525 mm	10	3802-525-38-2.00-10
6	550 mm	10	3802-550-38-2.00-6
4	550 mm	10	3802-550-50-2.50-4
6	550 mm	10	3802-550-50-2.50-6
8	550 mm	5	3802-550-50-2.50-8
10	550 mm	10	3802-550-50-2.50-10
4	575 mm	10	3802-575-50-2.50-4
6	575 mm	10	3802-575-50-2.50-6
4	600 mm	10	3802-600-50-2.50-4
6	600 mm	10	3802-600-50-2.50-6
8	600 mm	10	3802-600-50-2.50-8
4	650 mm	5	3802-650-50-2.50-4
6	650 mm	5	3802-650-50-2.50-6
3	700 mm	5	3802-700-50-2.50-3
4	700 mm	5	3802-700-50-2.50-4
6	700 mm	5	3802-700-50-2.50-6
4	750 mm	5	3802-750-50-2.50-4
6	750 mm	5	3802-750-50-2.50-6

Maskinsågblad i HSS för KASTO-maskiner



3802 KA

			
4	450 mm	10	3802-450-38-2.00-4-KA
6	450 mm	10	3802-450-38-2.00-6-KA
8	450 mm	10	3802-450-38-2.00-8-KA
10	450 mm	10	3802-450-38-2.00-10-KA
4	500 mm	10	3802-500-50-2.50-4-KA
6	500 mm	10	3802-500-50-2.50-6-KA
4	550 mm	10	3802-550-50-2.50-4-KA
8	550 mm	10	3802-550-50-2.50-8-KA
3	575 mm	10	3802-575-50-2.50-3-KA
4	575 mm	10	3802-575-50-2.50-4-KA
6	575 mm	10	3802-575-50-2.50-6-KA
4	650 mm	5	3802-650-50-2.50-4-KA
6	650 mm	5	3802-650-50-2.50-6-KA
2	700 mm	5	3802-700-50-2.50-2-KA
4	700 mm	5	3802-700-50-2.50-4-KA
6	700 mm	5	3802-700-50-2.50-6-KA



Filar



VERKSTADSFILAR

Oskaftade ansatsfilar grov/medium/fin



1-100...-0

100 mm	1		10	1-100-04-1-0
100 mm	2		10	1-100-04-2-0
100 mm	3		10	1-100-04-3-0
150 mm	1		10	1-100-06-1-0
150 mm	2		10	1-100-06-2-0
150 mm	3		10	1-100-06-3-0
200 mm	1		10	1-100-08-1-0
200 mm	2		10	1-100-08-2-0
200 mm	3		10	1-100-08-3-0
250 mm	1		10	1-100-10-1-0
250 mm	2		10	1-100-10-2-0
250 mm	3		10	1-100-10-3-0
300 mm	1		5	1-100-12-1-0
300 mm	2		5	1-100-12-2-0
300 mm	3		5	1-100-12-3-0
350 mm	1		5	1-100-14-1-0
350 mm	2		5	1-100-14-2-0

Type of cut: 1 = Bastard, 2 = Second, 3 = Smooth

ERGO™ ansatsfilar grov/medium/fin



ergo



1-100...-2

100 mm	1		5	1-100-04-1-2
100 mm	2		5	1-100-04-2-2
150 mm	1		5	1-100-06-1-2
150 mm	2		5	1-100-06-2-2
150 mm	3		5	1-100-06-3-2
200 mm	1		5	1-100-08-1-2
200 mm	2		5	1-100-08-2-2
200 mm	3		5	1-100-08-3-2
250 mm	1		5	1-100-10-1-2
250 mm	2		5	1-100-10-2-2
250 mm	3		5	1-100-10-3-2
300 mm	1		5	1-100-12-1-2
300 mm	2		5	1-100-12-2-2
300 mm	3		5	1-100-12-3-2

Type of cut: 1 = Bastard, 2 = Second, 3 = Smooth

Oskaftade slitsfilar grov/medium/fin



1-102

150 mm		2		10 1-102-06-2-0
150 mm		3		10 1-102-06-3-0
200 mm		1		10 1-102-08-1-0
200 mm		2		10 1-102-08-2-0
200 mm		3		10 1-102-08-3-0

Type of cut: 1 = Bastard, 2 = Second, 3 = Smooth

Oskaftad svarvfil, medelgrov och fin huggning



1-104

250 mm		2		10 1-104-10-2-0
250 mm		3		10 1-104-10-3-0
300 mm		2		5 1-104-12-2-0
300 mm		3		5 1-104-12-3-0
350 mm		3		5 1-104-14-3-0

Type of cut: 1 = Bastard, 2 = Second, 3 = Smooth

Oskaftad flat ansatsfil av typen "Öberg Cut", grov huggning



1-106...-0

200 mm		1		10 1-106-08-1-0
250 mm		1		10 1-106-10-1-0
300 mm		1		5 1-106-12-1-0

Type of cut: 1 = Bastard, 2 = Second, 3 = Smooth

ERGO™ ansatsfil av typen "Öberg Cut", grov huggning



ergo



1-106...-2

200 mm		1		5 1-106-08-1-2
250 mm		1		5 1-106-10-1-2
300 mm		1		5 1-106-12-1-2

Type of cut: 1 = Bastard, 2 = Second, 3 = Smooth

Oskaftade avsmalnande ansatsfilar grov/medium/fin



1-110...-0

100 mm		1		10 1-110-04-1-0
100 mm		2		10 1-110-04-2-0
100 mm		2		10 1-110-04-3-0
150 mm		1		10 1-110-06-1-0
150 mm		2		10 1-110-06-2-0
150 mm		3		10 1-110-06-3-0
200 mm		1		10 1-110-08-1-0
200 mm		2		10 1-110-08-2-0
200 mm		2		10 1-110-08-3-0
250 mm		1		10 1-110-10-1-0
250 mm		2		10 1-110-10-2-0
250 mm		3		10 1-110-10-3-0
300 mm		1		5 1-110-12-1-0
300 mm		2		5 1-110-12-2-0
300 mm		3		5 1-110-12-3-0
350 mm		1		5 1-110-14-1-0

Type of cut: 1 = Bastard, 2 = Second, 3 = Smooth

ERGO™ avsmalnande flat fil grov/
medium/fin



ergo



1-110...-2



150 mm	1	5	1-110-06-1-2
150 mm	2	5	1-110-06-2-2
150 mm	3	5	1-110-06-3-2
200 mm	1	5	1-110-08-1-2
200 mm	2	5	1-110-08-2-2
200 mm	3	5	1-110-08-3-2
250 mm	1	5	1-110-10-1-2
250 mm	2	5	1-110-10-2-2
250 mm	3	5	1-110-10-3-2
300 mm	1	5	1-110-12-1-2
300 mm	2	5	1-110-12-2-2
300 mm	3	5	1-110-12-3-2

Type of cut: 1 = Bastard, 2 = Second, 3 = Smooth

Flat oskaftad rymfil, grov, medelgrov och
fin huggning



1-111...-0



100 mm	1	10	1-111-04-1-0
100 mm	2	10	1-111-04-2-0
100 mm	3	10	1-111-04-3-0
150 mm	1	10	1-111-06-1-0
150 mm	2	10	1-111-06-2-0
150 mm	3	10	1-111-06-3-0
200 mm	1	10	1-111-08-1-0
200 mm	2	10	1-111-08-2-0

Type of cut: 1 = Bastard, 2 = Second, 3 = Smooth

ERGO™ flata rymfilar medelgrov huggning



ergo



1-111...-2



150 mm	2	5	1-111-06-2-2
--------	---	---	--------------

Type of cut: 1 = Bastard, 2 = Second, 3 = Smooth

Oskaftad magnetfil, fin huggning



1-115



110 mm	3	10	1-115-11-3-1
--------	---	----	--------------

Oskaftade flata skärpilar med 2 flata
kanter grov/medelgrov huggning



1-143...-0



100 mm	1	10	1-143-04-1-0
150 mm	1	10	1-143-06-1-0
200 mm	1	10	1-143-08-1-0
250 mm	1	10	1-143-10-1-0
300 mm	1	5	1-143-12-1-0

Type of cut: 1 = Bastard, 2 = Second, 3 = Smooth

ERGO™ flata skärpilar med 2 flata kanter
grov/medelgrov huggning



ergo



1-143...-2



150 mm	1	5	1-143-06-1-2
200 mm	1	5	1-143-08-1-2
250 mm	1	5	1-143-10-1-2
300 mm	1	5	1-143-12-1-2

Type of cut: 1 = Bastard, 2 = Second, 3 = Smooth

ERGO™ diagonalfil, medelgrov huggning



ergo



1-320 ...-2



200 mm	2	5	1-320-08-2-2
250 mm	2	5	1-320-10-2-2
300 mm	2	5	1-320-12-2-2

Type of cut: 1 = Bastard, 2 = Second, 3 = Smooth

Oskaftad diagonalfil, medelgrov huggning



1-320...-0



200 mm	2	10	1-320-08-2-0
250 mm	2	10	1-320-10-2-0
300 mm	2	5	1-320-12-2-0

Type of cut: 1 = Bastard, 2 = Second, 3 = Smooth



Oskaftade halvrunda filar grov/medium/fin



1-210...-0

Length	Cut	Quantity	Part No.
100 mm	1	10	1-210-04-1-0
100 mm	2	10	1-210-04-2-0
100 mm	3	10	1-210-04-3-0
150 mm	1	10	1-210-06-1-0
150 mm	2	10	1-210-06-2-0
150 mm	3	10	1-210-06-3-0
200 mm	1	10	1-210-08-1-0
200 mm	2	10	1-210-08-2-0
200 mm	3	10	1-210-08-3-0
250 mm	1	10	1-210-10-1-0
250 mm	2	10	1-210-10-2-0
250 mm	3	10	1-210-10-3-0
300 mm	1	5	1-210-12-1-0
300 mm	2	5	1-210-12-2-0
300 mm	3	5	1-210-12-3-0
350 mm	1	5	1-210-14-1-0

Type of cut: 1 = Bastard, 2 = Second, 3 = Smooth

Oskaftad rund fil, grov, medelgrov och fin huggning



1-230...-0

Length	Cut	Quantity	Part No.
100 mm	1	10	1-230-04-1-0
100 mm	2	10	1-230-04-2-0
100 mm	3	10	1-230-04-3-0
150 mm	1	10	1-230-06-1-0
150 mm	2	10	1-230-06-2-0
150 mm	3	10	1-230-06-3-0
200 mm	1	10	1-230-08-1-0
200 mm	2	10	1-230-08-2-0
200 mm	3	10	1-230-08-3-0
250 mm	1	10	1-230-10-1-0
250 mm	2	10	1-230-10-2-0
250 mm	3	10	1-230-10-3-0
300 mm	1	5	1-230-12-1-0
300 mm	2	5	1-230-12-2-0
300 mm	3	5	1-230-12-3-0

Type of cut: 1 = Bastard, 2 = Second, 3 = Smooth

Oskaftad trekantsfil, grov, medelgrov och fin huggning



1-170...-0

Length	Cut	Quantity	Part No.
100 mm	1	10	1-170-04-1-0
100 mm	2	10	1-170-04-2-0
100 mm	3	10	1-170-04-3-0
150 mm	1	10	1-170-06-1-0
150 mm	2	10	1-170-06-2-0
150 mm	3	10	1-170-06-3-0
200 mm	1	10	1-170-08-1-0
200 mm	2	10	1-170-08-2-0
200 mm	3	10	1-170-08-3-0
250 mm	1	10	1-170-10-1-0
250 mm	2	10	1-170-10-2-0
250 mm	3	10	1-170-10-3-0
300 mm	1	5	1-170-12-1-0
300 mm	2	5	1-170-12-2-0

Type of cut: 1 = Bastard, 2 = Second, 3 = Smooth

ERGO™ halvrunda filar grov/medium/fin



1-210...-2

Length	Cut	Quantity	Part No.
100 mm	1	5	1-210-04-1-2
100 mm	2	5	1-210-04-2-2
150 mm	1	5	1-210-06-1-2
150 mm	2	5	1-210-06-2-2
150 mm	3	5	1-210-06-3-2
200 mm	1	5	1-210-08-1-2
200 mm	2	5	1-210-08-2-2
200 mm	3	5	1-210-08-3-2
250 mm	1	5	1-210-10-1-2
250 mm	2	5	1-210-10-2-2
250 mm	3	5	1-210-10-3-2
300 mm	1	5	1-210-12-1-2
300 mm	2	5	1-210-12-2-2
300 mm	3	5	1-210-12-3-2

Type of cut: 1 = Bastard, 2 = Second, 3 = Smooth

ERGO™ runda filar grov/medium/fin



1-230...-2

Length	Cut	Quantity	Part No.
100 mm	1	5	1-230-04-1-2
100 mm	2	5	1-230-04-2-2
150 mm	1	5	1-230-06-1-2
150 mm	2	5	1-230-06-2-2
150 mm	3	5	1-230-06-3-2
200 mm	1	5	1-230-08-1-2
200 mm	2	5	1-230-08-2-2
200 mm	3	5	1-230-08-3-2
250 mm	1	5	1-230-10-1-2
250 mm	2	5	1-230-10-2-2
250 mm	3	5	1-230-10-3-2
300 mm	1	5	1-230-12-1-2
300 mm	2	5	1-230-12-2-2
300 mm	3	5	1-230-12-3-2

Type of cut: 1 = Bastard, 2 = Second, 3 = Smooth

ERGO™ trekantsfil, grov, medelgrov och fin huggning



1-170...-2

Length	Cut	Quantity	Part No.
100 mm	2	5	1-170-04-2-2
150 mm	1	5	1-170-06-1-2
150 mm	2	5	1-170-06-2-2
150 mm	3	5	1-170-06-3-2
200 mm	1	5	1-170-08-1-2
200 mm	2	5	1-170-08-2-2
200 mm	3	5	1-170-08-3-2
250 mm	1	5	1-170-10-1-2
250 mm	2	5	1-170-10-2-2
250 mm	3	5	1-170-10-3-2

Type of cut: 1 = Bastard, 2 = Second, 3 = Smooth

Oskaffad fyrkantsfil, grov, medelgrov och fin huggning



1-160...-0



100 mm	1	10	1-160-04-1-0
100 mm	2	10	1-160-04-2-0
100 mm	3	10	1-160-04-3-0
150 mm	1	10	1-160-06-1-0
150 mm	2	10	1-160-06-2-0
150 mm	3	10	1-160-06-3-0
200 mm	1	10	1-160-08-1-0
200 mm	2	10	1-160-08-2-0
200 mm	3	10	1-160-08-3-0
250 mm	1	10	1-160-10-1-0
250 mm	2	10	1-160-10-2-0
250 mm	3	10	1-160-10-3-0
300 mm	1	5	1-160-12-1-0
300 mm	2	5	1-160-12-2-0
300 mm	3	5	1-160-12-3-0

Type of cut: 1 = Bastard, 2 = Second, 3 = Smooth

ERGO™ fyrkantsfil, grov, medelgrov och fin huggning



1-160...-2



100 mm	1	5	1-160-04-1-2
100 mm	2	5	1-160-04-2-2
150 mm	1	5	1-160-06-1-2
150 mm	2	5	1-160-06-2-2
150 mm	3	5	1-160-06-3-2
200 mm	1	5	1-160-08-1-2
200 mm	2	5	1-160-08-2-2
200 mm	3	5	1-160-08-3-2
250 mm	1	5	1-160-10-1-2
250 mm	2	5	1-160-10-2-2
250 mm	3	5	1-160-10-3-2
300 mm	1	5	1-160-12-1-2
300 mm	2	5	1-160-12-2-2
300 mm	3	5	1-160-12-3-2

Type of cut: 1 = Bastard, 2 = Second, 3 = Smooth

ERGO™ sats med filar med fint snitt-6 st.



1-476



100 mm	3	1	1-476-04-3-2
--------	---	---	--------------

1-160-04-3-2, 1-111-04-3-2, 1-230-04-3-2, 1-170-04-3-2, 1-210-04-3-2, 1-100-04-3-2, 1-160-04-3-2, 1-111-04-3-2, 1-230-04-3-2, 1-170-04-3-2, 1-210-04-3-2, 1-100-04-3-2

ERGO™ ansatsfilsats med medelgrov huggning, 150 mm – 3 st.



1-473



150 mm	2	5	1-473-06-2-2
--------	---	---	--------------

1-230-06-2-2	
1-210-06-2-2	
1-100-06-2-2	

ERGO™ sats med filar med medelgrov huggning 200 mm-3 st.



1-473-08-2-2



200 mm	2	5	1-473-08-2-2
--------	---	---	--------------

1-230-08-2-2



1-210-08-2-2



1-100-08-2-2



ERGO™ sats med filar med medelgrov huggning 250 mm-3 st.



1-473-10-2-2 1

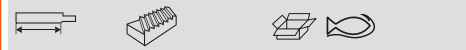

250 mm	2	5	1-473-10-2-2
--------	---	---	--------------

1-230-10-2-2

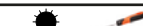

1-210-10-2-2



1-100-10-2-2



ERGO™ sats med halvrund rasp med medelgrov huggning 200 mm-5 st.



1-477



200 mm	2	5	1-477-08-2-2
--------	---	---	--------------

1-100-08-2-2



1-210-08-2-2



6-343-08-2-2

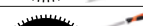

1-230-08-2-2



1-170-08-2-2



ERGO™ sats med halvrund rasp med medelgrov huggning 250 mm–5 st.



ergo



1-477-10-2-2

250 mm	2	5	1-477-10-2-2

1-100-10-2-2		
1-210-10-2-2		
6-343-10-2-2		
1-230-10-2-2		
1-170-10-2-2		

ERGO™ sats med 4 filar med grov huggning/1 fil med medelgrov huggning 200 mm–5 st.



ergo



1-478

200 mm	1&2	5	1-478-08-1-2

1-210-08-1-2		
1-230-08-1-2		
1-100-08-1-2, 1-100-08-2-2		
1-160-08-1-2		

ERGO™ sats med 4 filar med grov huggning/1 fil med medelgrov huggning 250 mm–5 st.



ergo



1-478-10-1-2_1

250 mm	1&2	5	1-478-10-1-2

1-210-10-1-2		
1-230-10-1-2		
1-100-10-1-2, 1-100-10-2-2		
1-160-10-1-2		

ERGO™ ansatsfilsats med kabinettrasp och grov huggning, 200 mm – 5 st.



ergo



1-479

200 mm	1	5	1-479-08-1-2

4-138-08-1-2		
1-210-08-1-2		
6-343-08-2-2		
1-230-08-1-2		
1-100-08-1-2		

ERGO™ filsats med kabinettrasp och medelgrov huggning, 200 mm – 5 st.



ergo



1-479-08-2-2

200 mm	2	5	1-479-08-2-2

4-138-08-1-2		
1-210-08-2-2		
6-343-08-2-2		
1-230-08-2-2		
1-100-08-2-2		

SKÄRPFILAR

ERGO™ flat sågkedjefil



ergo



166-2

150 mm	3	5	166-6-16-2.5-2

Flata sågkedjefilar, oskaftade



166/167-12

150 mm	3	12	166-6-16-2.5-12
200 mm	1	12	167-8-21-3.2-12

Runda motorsågsfilar–12 x 1-pack



168-1P

150 mm	3.2 mm	12	168-6-3.2-1P
150 mm	3.5 mm	12	168-6-3.5-1P
200 mm	4.0 mm	12	168-8-4.0-1P
200 mm	4.5 mm	12	168-8-4.5-1P
200 mm	4.8 mm	12	168-8-4.8-1P
200 mm	5.2 mm	12	168-8-5.2-1P
200 mm	5.5 mm	12	168-8-5.5-1P
200 mm	6.3 mm	12	168-8-6.3-1P

Runda sågkedjefilar-12 x 3-pack



168-3P

Length	Thickness	Quantity	Part No.
150 mm	3.2 mm	12	168-6-3.2-3P
150 mm	3.5 mm	12	168-6-3.5-3P
200 mm	4.0 mm	12	168-8-4.0-3P
200 mm	4.5 mm	12	168-8-4.5-3P
200 mm	4.8 mm	12	168-8-4.8-3P
200 mm	5.2 mm	12	168-8-5.2-3P
200 mm	5.5 mm	12	168-8-5.5-3P
200 mm	6.3 mm	12	168-8-6.3-3P

Sats med ERGO™ motorsågsfilor med tvåkomponentshandtag



168-C

Length	Thickness	Quantity	Part No.
200 mm	4.0 mm	10	168-COMBI-4.0
200 mm	4.5 mm	10	168-COMBI-4.5
200 mm	4.8 mm	10	168-COMBI-4.8
200 mm	5.5 mm	10	168-COMBI-5.5

Oskaffade flata skärpfilor med 2 runda kanter, grov huggning



4-140...-0

Length	Quantity	Part No.
150 mm	1	10 4-140-06-1-0
200 mm	1	10 4-140-08-1-0
250 mm	1	10 4-140-10-1-0

Runda motorsågsfilor-6-pack



168-8

Length	Thickness	Quantity	Part No.
200 mm	4.0 mm	6	168-8-4.0-6
200 mm	4.5 mm	6	168-8-4.5-6
200 mm	4.8 mm	6	168-8-4.8-6
200 mm	5.2 mm	6	168-8-5.2-6
200 mm	5.5 mm	6	168-8-5.5-6

Oskaffad flat skärpfil med en rund kant och grov huggning



4-138...-0

Length	Quantity	Part No.
150 mm	1	10 4-138-06-1-0
200 mm	1	10 4-138-08-1-0
250 mm	1	10 4-138-10-1-0
300 mm	1	5 4-138-12-1-0

ERGO™ flat skärpfil med tvåkomponentshandtag och två runda kanter, grov huggning



4-140...-2

Length	Quantity	Part No.
200 mm	1	5 4-140-08-1-2
250 mm	1	5 4-140-10-1-2

Sats med ERGO™ motorsågsfilor med tvåkomponentshandtag och en filmall



168-C-G

Length	Thickness	Quantity	Part No.
200 mm	4.0 mm	10	168-COMBI-4.0-6922
200 mm	4.8 mm	10	168-COMBI-4.8-6920
200 mm	5.5 mm	10	168-COMBI-5.5-6924

ERGO™ flata skärpfilor med tvåkomponentshandtag och 1 rund, grov kant



4-138...-2

Length	Quantity	Part No.
150 mm	1	5 4-138-06-1-2
200 mm	1	5 4-138-08-1-2
250 mm	1	5 4-138-10-1-2
300 mm	1	5 4-138-12-1-2

Oskaffad flat skärpfil med två raka kanter, grov huggning



4-142

Length	Quantity	Part No.
150 mm	1	10 4-142-06-1-0
200 mm	1	10 4-142-08-1-0
250 mm	1	10 4-142-10-1-0



Oskaffad flat skärpfil med en rund kant, extra tunn, medelgrov huggning



4-144...-0

200 mm	2	10	4-144-08-2-0

ERGO™ flat skärpfil med tvåkomponentshandtag och en rund kant, medelgrov huggning



4-144...-2

200 mm	2	5	4-144-08-2-2

2-i-1 ERGO™ hobbyfil för trä och metall, med tvåkomponentshandtag



4-152

200 mm	2 & 2	5	4-152-08-2-2

2-i-1 ERGO™ hobbyfil för metall, med tvåkomponentshandtag



4-153

200 mm	1 & 1	5	4-153-08-1-2

4-i-2 ERGO™ sats med hobbyfil för trä och metall, med tvåkomponentshandtag



4-154

200 mm	1 & 2	10	4-154-08-2-2

2-i-1 lantbruksfil, grov huggning



4-155

200 mm	1	10	4-155-08-2-0
250 mm	1	5	4-155-10-2-0

Oskaffad trekantig sågfil, medelgrov huggning



4-183...-0

100 mm	2	10	4-183-04-2-0
112 mm	2	10	4-183-45-2-0
125 mm	2	10	4-183-05-2-0
150 mm	2	10	4-183-06-2-0
175 mm	2	10	4-183-07-2-0
200 mm	2	10	4-183-08-2-0
250 mm	2	10	4-183-10-2-0

ERGO™ trekantig sågfil med tvåkomponentshandtag och medelgrov huggning



4-183...-2

100 mm	2	5	4-183-04-2-2
125 mm	2	5	4-183-05-2-2
150 mm	2	5	4-183-06-2-2
175 mm	2	5	4-183-07-2-2
200 mm	2	5	4-183-08-2-2

Avsmalnande sågfil, medelgrov huggning, oskaffade



4-186...-0

100 mm	2	10	4-186-04-2-0
112 mm	2	10	4-186-45-2-0
125 mm	2	10	4-186-05-2-0
150 mm	2	10	4-186-06-2-0
175 mm	2	10	4-186-07-2-0
200 mm	2	10	4-186-08-2-0

ERGO™ avsmalnande fil med tvåkomponentshandtag och medelgrov huggning



ergo®



4-186...-2

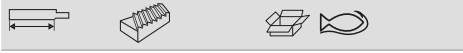

100 mm	2	5	4-186-04-2-2
125 mm	2	5	4-186-05-2-2
150 mm	2	5	4-186-06-2-2

Oskafad extra smal trekantig sågfil, medelgrov huggning



4-188...-0

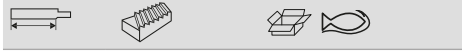

125 mm	2	10	4-188-05-2-0
150 mm	2	10	4-188-06-2-0

ERGO™ dubbelsidig sågfil med tvåkomponentshandtag och medelgrov huggning



ergo®



4-190...-2

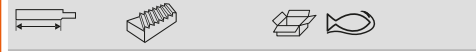

150 mm	2	5	4-190-06-2-2
175 mm	2	5	4-190-07-2-2
200 mm	2	5	4-190-08-2-2

Oskafad trekantig sågfil, medelgrov huggning



4-187...-0

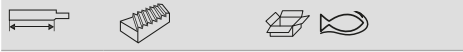

100 mm	2	10	4-187-04-2-0
112 mm	2	10	4-187-45-2-0
125 mm	2	10	4-187-05-2-0
150 mm	2	10	4-187-06-2-0
175 mm	2	10	4-187-07-2-0

ERGO™ dubbel extra smal spetsig fil med tvåkomponentshandtag och medelgrov huggning



ergo®



4-188...-2

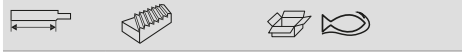

125 mm	2	5	4-188-05-2-2
--------	---	---	--------------

Oskafad avsmalnande bandsågsfil, medelgrov huggning



4-192...-0

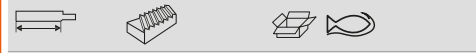

150 mm	2	10	4-192-06-2-0
175 mm	2	10	4-192-07-2-0
200 mm	2	10	4-192-08-2-0

ERGO™ extra smal spetsig fil med tvåkomponentshandtag och medelgrov huggning



ergo®



4-187...-2

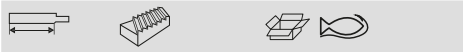

125 mm	2	5	4-187-05-2-2
150 mm	2	5	4-187-06-2-2

Otångad sågfil med trähandtag, medelgrov huggning



4-190...-0

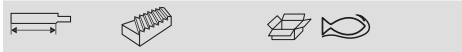

175 mm	2	10	4-190-07-2-0
200 mm	2	10	4-190-08-2-0

ERGO™ avsmalnande bandsågsfil med tvåkomponentshandtag och medelgrov huggning



ergo®



4-192...-2

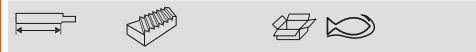

150 mm	2	5	4-192-06-2-2
200 mm	2	5	4-192-08-2-2



Bandsågbladsfil, medelgrov huggning



4-202-4-204



216 mm	2	10	4-202-85-2-0
216 mm	2	10	4-204-85-2-0

Wasa™ oskaftad dubbel sågfil med fin huggning



4-272...-0



150 mm	3	10	4-272-06-3-0
--------	---	----	--------------

ERGO™ Wasa™ dubbla sågfilar med fint snitt och tvåkomponentshandtag



4-272...-2



125 mm	3	5	4-272-05-3-2
150 mm	3	5	4-272-06-3-2

RASPAR

Oskaftad flat rasp, medelgrov huggning



6-344...-0



200 mm	2	10	6-344-08-2-0
250 mm	2	10	6-344-10-2-0

ERGO™ flat rasp, medelgrov huggning



6-344...-2



200 mm	2	5	6-344-08-2-2
250 mm	2	5	6-344-10-2-2

Oskaftad halvrand rasp, grov och medelgrov huggning



6-342...-0



150 mm	2	10	6-342-06-2-0
200 mm	1	10	6-342-08-1-0
200 mm	2	10	6-342-08-2-0
250 mm	1	10	6-342-10-1-0
250 mm	2	10	6-342-10-2-0

ERGO™ halvruna raspar grovt/medelgrovt snitt



6-342...-2



150 mm	2	5	6-342-06-2-2
200 mm	1	5	6-342-08-1-2
200 mm	2	5	6-342-08-2-2
250 mm	1	5	6-342-10-1-2
250 mm	2	5	6-342-10-2-2

Oskaftad halvrand kabinettrasp, medelgrov och fin huggning



6-343...-0



200 mm	2	10	6-343-08-2-0
200 mm	3	10	6-343-08-3-0
250 mm	2	10	6-343-10-2-0
250 mm	3	10	6-343-10-3-0

ERGO™ halvruna kabinettraspar, medelgrovt snitt



6-343...-2



200 mm	2	5	6-343-08-2-2
250 mm	2	5	6-343-10-2-2

Oskaftad rund rasp, medelgrov huggning



6-345...-0

200 mm	2	10	6-345-08-2-0
250 mm	2	10	6-345-10-2-0

ERGO™ rund rasp, grov och medelgrov huggning



6-345...-2

200 mm	1	5	6-345-08-1-2
200 mm	2	5	6-345-08-2-2
250 mm	1	5	6-345-10-1-2

Sats med ERGO™ raspar, medelgrov huggning – 3 st.



6-470

200 mm	2	5	6-470-08-2-2

6-345-08-2-2

6-342-08-2-2

4-152-08-2-2

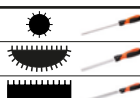

FRÄSTA FILAR

Pansar® oskaftad flat fil med frästa grader och grov och medelgrov huggning



3-330

300 mm	1	5	3-330-12-1-0
300 mm	2	5	3-330-12-2-0
350 mm	1	5	3-330-14-1-0
350 mm	2	5	3-330-14-2-0

Pansar® oskaftad halvrund fil med frästa grader och grov huggning



3-331

350 mm	1	5	3-331-14-1-0

ERGO™ filemaster med fräst grad och tvåkomponentshandtag



FM10

300 mm	4 & 5	5	FM12
250 mm	4 & 5	5	FM10

ERGO™ halvrund filemaster med fräst grad och tvåkomponentshandtag



HRFM10

250 mm	5	5	HRFM10

NÅLFILAR

Flata nålfilar, oskaftade, grov/medelgrov/fin/extrafin huggning



2-300

140 mm	0	10	2-300-14-0-0
140 mm	2	10	2-300-14-2-0
140 mm	4	10	2-300-14-4-0
160 mm	0	10	2-300-16-0-0
160 mm	1	10	2-300-16-1-0
160 mm	2	10	2-300-16-2-0
160 mm	4	10	2-300-16-4-0
180 mm	0	10	2-300-18-0-0
180 mm	2	10	2-300-18-2-0

Flat oskaftad avsmalnande nålfil, grov, medelgrov och fin huggning



2-301

140 mm	0	10	2-301-14-0-0
140 mm	2	10	2-301-14-2-0
160 mm	0	10	2-301-16-0-0
160 mm	1	10	2-301-16-1-0
160 mm	2	10	2-301-16-2-0



Halvrunda nålfilar, oskaftade, grov/
medelgrov/fin/extrafin huggning



2-304

Length	Coarseness	Quantity	Part No.
140 mm	0	10	2-304-14-0-0
140 mm	2	10	2-304-14-2-0
140 mm	4	10	2-304-14-4-0
160 mm	0	10	2-304-16-0-0
160 mm	1	10	2-304-16-1-0
160 mm	2	10	2-304-16-2-0
160 mm	4	10	2-304-16-4-0
180 mm	0	10	2-304-18-0-0
180 mm	2	10	2-304-18-2-0

Oskaftad oval nålfil, medelgrov och fin
huggning



2-305

Length	Coarseness	Quantity	Part No.
160 mm	1	10	2-305-16-1-0
160 mm	2	10	2-305-16-2-0

Oskaftad nålfil av barettyp, fin/extrafin
huggning



2-309

Length	Coarseness	Quantity	Part No.
160 mm	2	10	2-309-16-2-0
160 mm	4	10	2-309-16-4-0

Halvrund oskaftad nålfil, grov huggning



2-313

Length	Coarseness	Quantity	Part No.
160 mm	0	10	2-313-16-0-0

Oskaftad fågeltunga, medelgrov, fin
huggning



2-306

Length	Coarseness	Quantity	Part No.
160 mm	1	10	2-306-16-1-0
160 mm	2	10	2-306-16-2-0

Oskaftad nålfil av knivtyp, grov, medelgrov
och fin huggning



2-308

Length	Coarseness	Quantity	Part No.
140 mm	2	10	2-308-14-2-0
160 mm	0	10	2-308-16-0-0
160 mm	1	10	2-308-16-1-0
160 mm	2	10	2-308-16-2-0

Oskaftad rund nålfil, grov, medelgrov, fin
och extrafin huggning



2-307

Length	Coarseness	Quantity	Part No.
140 mm	0	10	2-307-14-0-0
140 mm	2	10	2-307-14-2-0
140 mm	4	10	2-307-14-4-0
160 mm	0	10	2-307-16-0-0
160 mm	1	10	2-307-16-1-0
160 mm	2	10	2-307-16-2-0
160 mm	4	10	2-307-16-4-0
180 mm	0	10	2-307-18-0-0
180 mm	2	10	2-307-18-2-0

Oskaftad trekantig nålfil, grov/medelgrov/
fin/extrafin huggning



2-302

Length	Coarseness	Quantity	Part No.
140 mm	0	10	2-302-14-0-0
140 mm	2	10	2-302-14-2-0
140 mm	4	10	2-302-14-4-0
160 mm	0	10	2-302-16-0-0
160 mm	1	10	2-302-16-1-0
160 mm	2	10	2-302-16-2-0
160 mm	4	10	2-302-16-4-0
180 mm	0	10	2-302-18-0-0
180 mm	2	10	2-302-18-2-0

Oskaftad fyrkantig nålfil med grov,
medelgrov, fin och extrafin huggning



2-303

Length	Coarseness	Quantity	Part No.
140 mm	2	10	2-303-14-2-0
160 mm	0	10	2-303-16-0-0
160 mm	1	10	2-303-16-1-0
160 mm	2	10	2-303-16-2-0
160 mm	4	10	2-303-16-4-0
180 mm	0	10	2-303-18-0-0
180 mm	2	10	2-303-18-2-0

Sats med oskaftade nålfilar, grov huggning, 140 mm – 6 st.

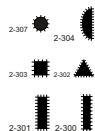

2-470



9-488-02-10	
2-304-14-0-0	
2-300-14-0-0	
2-303-14-0-0	
2-302-14-0-0	
2-301-14-0-0	
2-307-14-0-0	

Sats med oskaftade nålfilar, fin huggning, 140 mm – 6 st.



2-470-14-2-0



9-488-02-10	
2-304-14-2-0	
2-300-14-2-0	
2-303-14-2-0	
2-302-14-2-0	
2-301-14-2-0	
2-307-14-2-0	

Sats med oskaftade nålfilar, extrafin huggning, 140 mm – 6 st.



2-470-14-4-0



9-488-02-10	
2-304-14-4-0	
2-300-14-4-0	
2-303-14-4-0, 2-301-14-4-0	
2-302-14-4-0	
2-307-14-4-0	

Set med oskaftade nålfilar med medelgrov huggning 160 mm–6 st.



2-470-16-1-0



9-488-02-10	
2-304-16-1-0	
2-300-16-1-0	
2-303-16-1-0	
2-302-16-1-0	
2-301-16-1-0	
2-307-16-1-0	

Sats med oskaftade nålfilar med fint snitt 160 mm–6 st



2-470-16-2-0



9-488-02-10	
2-304-16-2-0	
2-300-16-2-0	
2-303-16-2-0	
2-302-16-2-0	
2-301-16-2-0	
2-307-16-2-0	

Sats med oskaftade nålfilar med medelgrov huggning 160 mm–9 st.



2-471

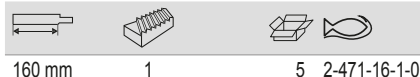

9-488-02-10	
2-303-16-1-0	
2-304-16-1-0	
2-302-16-1-0	
2-300-16-1-0	
2-308-16-1-0	
2-301-16-1-0	
2-306-16-1-0	
2-305-16-1-0	
2-307-16-1-0	



Sats med oskaftade nålfilar, grov huggning, 140 mm – 12 st.



2-472



2-312-14-0-0, 2-311-14-0-0, 2-308-14-0-0

2-303-14-0-0, 2-313-14-0-0, 2-309-14-0-0, 2-306-14-0-0

2-300-14-0-0	
2-301-14-0-0	
2-304-14-0-0	
2-302-14-0-0	
2-307-14-0-0	
9-488-02-10	

Sats med oskaftade nålfilar med fin huggning, 140 mm – 12 st.



2-472-14-2-0



2-312-14-2-0, 2-311-14-2-0, 2-309-14-2-0

2-303-14-2-0	
2-300-14-2-0	
2-301-14-2-0	
2-304-14-2-0	
2-302-14-2-0	
2-313-14-2-0, 2-306-14-2-0	
2-307-14-2-0	
2-308-14-2-0	
9-488-02-10	

Sats med oskaftade nålfilar med grov huggning, 160 mm – 12 st.



2-472-16-0-0



2-312-16-0-0, 2-311-16-0-0, 2-309-16-0-0

2-303-16-0-0	
2-300-16-0-0	
2-301-16-0-0	
2-304-16-0-0	
2-302-16-0-0	
2-313-16-0-0	
2-307-16-0-0	
2-306-16-0-0	
2-308-16-0-0	
9-488-02-10	

Sats med oskaftade nålfilar med medelgrov huggning 160 mm–12 st.



2-472-16-1-0



2-312-16-1-0, 2-313-16-1-0, 2-309-16-1-0

2-300-16-1-0	
2-301-16-1-0	
2-303-16-1-0	
2-304-16-1-0	
2-306-16-1-0	
2-307-16-1-0	
2-308-16-1-0	
2-309-16-2-0	
2-313-16-2-0	
9-488-02-10	

Sats med oskaftade nålfilar med fint snitt 160 mm–12 st.



2-472-16-2-0



2-312-16-2-0

2-303-16-2-0	
2-300-16-2-0	
2-301-16-2-0	
2-304-16-2-0	
2-302-16-2-0	
2-313-16-2-0	
2-307-16-2-0	
2-309-16-2-0	
2-306-16-2-0	
2-308-16-2-0	
9-488-02-10	

DIAMANTFILAR

Oskaftad diamantnåfil



2-300-D-2-304-D



140 mm	10	2-300-14-D-1P
160 mm	10	2-300-16-D-1P
140 mm	1	2-301-14-D-1P
140 mm	10	2-302-14-D-1P
160 mm	10	2-302-16-D-1P
140 mm	10	2-303-14-D-1P
160 mm	1	2-303-16-D-1P
140 mm	10	2-304-14-D-1P
160 mm	10	2-304-16-D-1P

Oskaffad diamantnåfil, 140/160 mm



2-306-D-2-308-D

140 mm	1	2-306-14-D-1P
140 mm	10	2-307-14-D-1P
160 mm	10	2-307-16-D-1P
140 mm	1	2-308-14-D-1P

Vändbara hållare för flata Pansar®-blad, 12" och 14" (3-330)



9-463

300 & 350 mm	1	9-463-14-0-0

Universalhandtag för nålfilar



9-488-02

5 g	10	9-488-02-10

Diamantnåfil med handtag



5-600-D-5-670-D

215 mm	10	5-600-21-D-1P
215 mm	5	5-610-21-D-1P
215 mm	1	5-630-21-D-1P
215 mm	1	5-670-21-D-1P

Plasthandtag för 8" rund motorsågsfil



PH-6604

55 g	15	PH-6604-1P
50 g	25	PH-6604-25

Filkarda med stålborst och trähandtag



9-469

110 mm	240 mm	1 9-469-00-0-0

ERGO™ runda handtag för små filar – 10-pack



ergo



9-484...10

3.2	3.2 mm	10 9-484-3.2-10
5.2	5.2 mm	10 9-484-5.2-10

ERGO™ runda handtag för små filar – styckförpackade



ergo



9-484...1P

3.2	3.2 mm	10 9-484-3.2-1P
5.2	5.2 mm	10 9-484-5.2-1P

TILLBEHÖR

Aluminiumhållare för flata Pansar® 14"-blad (3-330)



9-462

350 mm	5	9-462-14-0-0

Filkarda med stålborst



9-467

130 mm	260 mm	1 9-467-00-0-0



ERGO™ ovala handtag för flata och halvrunda filar – 10-pack



ergo



9-485...10

File Size	File Width	Quantity	Product Code
4	4 mm	10	9-485-04-10
5	5 mm	10	9-485-05-10
6	6 mm	10	9-485-06-10
9	9 mm	10	9-485-09-10
13	13 mm	10	9-485-13-10

ERGO™ handtag för runda motorsågsfil
– styckförpackade



ergo



9-486-C-1P

File Size	File Width	Quantity	Product Code
3,2	3.2 mm	10	9-486-C-1P

ERGO™ ovala handtag för flata och halvrunda filar – styckförpackade



ergo



9-485...1P

File Size	File Width	Quantity	Product Code
4	4 mm	10	9-485-04-1P
5	5 mm	10	9-485-05-1P
6	6 mm	20	9-485-06-1P
9	9 mm	20	9-485-09-1P
13	13 mm	1	9-485-13-1P

ERGO™ handtag för rektangulära filar – 10-pack



ergo



9-486...10

File Size	File Width	Quantity	Product Code
4	4 mm	10	9-486-04-10
5	5 mm	10	9-486-05-10
7	7 mm	10	9-486-07-10
8	8 mm	10	9-486-08-10

ERGO™ handtag för runda motorsågsfil
– 10-pack



ergo



9-486-C-10

File Size	File Width	Quantity	Product Code
3,2	3.2 mm	10	9-486-C-10

ERGO™ runda handtag för rektangulära filar – styckförpackade



ergo



9-486...1P

File Size	File Width	Quantity	Product Code
4	4 mm	20	9-486-04-1P
5	5 mm	20	9-486-05-1P
7	7 mm	20	9-486-07-1P



Dragverktyg



SKIFTNYCKLAR

ERGO™ skiftnycklar med gummihandtag och fosfaterad yta



ergo



90

L	g	g	g
158mm/6"	20 mm	5	9070
208mm/8"	27 mm	5	9071
257mm/10"	31 mm	5	9072
308mm/12"	34 mm	5	9073

ERGO™ skiftnyckel med vändbar käft, fosfaterad yta och gummihandtag



ergo



90P

L	g	g	g
158mm/6"	21 mm	5	9070 P
208mm/8"	28 mm	5	9071 P
257mm/10"	33 mm	5	9072 P
308mm/12"	35 mm	5	9073 P

ERGO™ skiftnycklar med gummihandtag, förkromade



ergo



90C

L	g	g	g
158mm/6"	20 mm	5	9070C
208mm/8"	27 mm	5	9071C
257mm/10"	31 mm	5	9072 C
308mm/12"	34 mm	3	9073 C

ERGO™ skiftnyckel med vändbar käft, förkromad yta och gummihandtag



ergo



90PC

L	g	g	g
158mm/6"	21 mm	5	9070 PC
208mm/8"	28 mm	5	9071 PC
257mm/10"	33 mm	5	9072 PC
308mm/12"	35 mm	3	9073 PC

ERGO™ skiftnycklar med smala käftar som öppnas stort och gummihandtag



ergo



9029-T/9031-T

L	g	g	g
170mm/6"	32 mm	5	9029-T
218mm/8"	38 mm	5	9031-T

ERGO™ skiftnycklar med gummihandtag och fosfaterad yta



ergo



9029-9035

L	g	g	g
170mm/6"	32 mm	5	9029
218mm/8"	38 mm	5	9031
270mm/10"	46 mm	5	9033
324mm/12"	55 mm	5	9035

ERGO™ höger- och vänstergående skiftnycklar med extra stor käftöppning och gummihandtag



ergo



9031P

L	g	g	g
218mm/8"	39 mm	5	9031P

ERGO™ sats med skiftnycklar med gummihandtag



ergo



ADJUST3-90

g	g	g
900 g	1	ADJUST 3-90

9070, 9071, 9072



ERGO™ skiftnycklar, tvåpack



ergo



ADJUST9031/29



550 g



3 ADJUST 9031/29

9029, 9031



L	Icon 1	Icon 2	Icon 3
110mm/4"	13 mm	5	8069 C IP
155mm/6"	20 mm	5	8070 C IP
205mm/8"	27 mm	5	8071 C IP
255mm/10"	31 mm	5	8072 C IP
305mm/12"	34 mm	5	8073 C IP
380mm/15"	44 mm	3	8074 C IP
455mm/18"	53 mm	3	8075 C IP

Standardskiftnycklar med fosfaterad yta



86/87

L	Icon 1	Icon 2	Icon 3
614mm/24"	63 mm	1	86
770mm/30"	85 mm	3	87

Skiftnycklar med fosfaterad yta



80

L	Icon 1	Icon 2	Icon 3
110mm/4"	13 mm	5	8069
155mm/6"	20 mm	5	8070
205mm/8"	27 mm	5	8071
255mm/10"	31 mm	5	8072
305mm/12"	34 mm	5	8073
380mm/15"	44 mm	3	8074
455mm/18"	53 mm	3	8075
110mm/4"	13 mm	50	8069 IP
155mm/6"	20 mm	40	8070 IP
205mm/8"	27 mm	50	8071 IP
255mm/10"	31 mm	30	8072 IP
305mm/12"	34 mm	20	8073 IP
380mm/15"	44 mm	20	8074 IP
455mm/18"	53 mm	10	8075 IP

Satser med skiftnycklar



ADJUST3



810 g



1 ADJUST 3

8070, 8071, 8072

Standardskiftnycklar, förkromade



80C

L	Icon 1	Icon 2	Icon 3
110mm/4"	13 mm	5	8069 C
155mm/6"	20 mm	5	8070 C
205mm/8"	27 mm	5	8071 C
255mm/10"	31 mm	5	8072 C
305mm/12"	34 mm	5	8073 C
380mm/15"	44 mm	3	8074 C
455mm/18"	53 mm	3	8075 C

Reservdelssats till skiftnycklar i 80- och 90-serien



RPS



8069, 8069 C	1	8069-1
8070, 8070 C, 9070, 9070 C	1	8070-1
8071, 8071 C, 9071, 9071 C	1	8071-1

Icon 1	Icon 2	Icon 3
8072, 8072 C, 9072, 9072 C	1	8072-1
8073, 8073 C, 9073, 9073 C	1	8073-1
8074, 8074 C	1	8074-1
8075, 8075 C	1	8075-1
9029, 9029 C, 31	1	9029-1
9029-T	1	9029T-1
9031, 9031 C	1	9031-1
9031-T	1	9031T-1
9033, 33H	1	9033-1
9035	1	9035-1
86	1	86-1
87	1	87-1
9031 P	1	9031 P-1
9070 P, 9070 PC	1	9070 P-1
9071 P, 9071 PC	1	9071 P-1
9072 P, 9072 PC	1	9072 P-1
9073 P, 9073 PC	1	9073 P-1

Sats med rulle, stift och fjäder för skiftnyckel



RPS2

Icon 1	g	Icon 2	Icon 3
8069, 8069 C	3 g	1	8069-2
8070, 8070 C, 9070, 9070 C, 9070 P, 9070 PC	8 g	1	8070-2
8071, 8071 C, 9071, 9071 C, 9071 P, 9071 PC	10 g	1	8071-2
8072, 8072 C, 9072, 9072 C, 9072 P, 9072 PC	16 g	1	8072-2
8073, 8073 C, 9073, 9073 C, 9073 P, 9073 PC, 9033	25 g	1	8073-2
8074, 8074 C, 9035	47 g	1	8074-2
8075, 8075 C	54 g	1	8075-2
9029, 9029 C, 9029-T, 9031-T, 31, 9031, 9031 C, 9031 P	9 g	1	9029-2
86	125 g	1	86-2
87	185 g	1	87-2



Ställningsnyckel med svartoxiderad yta



84

405mm/16"	41 mm	1	84-PODGER

Skiftnyckel med extra stor gripvidd och rörgrepp i skaftänden och med fosfaterad yta



31

209mm/8"	32 mm	5	31
209mm/8"	32 mm	50	31 IP

Skiftnyckel med tunna käftar och skaftände med rörgrepp. Svartoxiderad yta



31-T

209mm/8"	32 mm	5	31-T
209mm/8"	32 mm	50	31-T IP

Skiftnycklar med krok och svartoxiderad yta



33H

254mm/10"	46 mm	5	33H

Skiftnyckel med sidoskruv, gummihandtag och svartoxiderad yta



95

257mm/10"	35 mm	5	9572

Skiftnyckel med sidoskruv, förkromad



91C/97C

155mm/6"	21 mm	5	91C
205mm/8"	29 mm	5	92C
255mm/10"	34 mm	5	93C
305mm/12"	39 mm	5	94C
405mm/16"	48 mm	1	95C
500mm/20"	60 mm	1	96C
750mm/30"	77 mm	1	97C



U-RINGNYCKLAR

Metrisk u-ringnycklar, förkromade



111M



5.5 mm	10	111M-5.5
6 mm	10	111M-6
7 mm	10	111M-7
8 mm	10	111M-8
9 mm	10	111M-9
10 mm	10	111M-10
11 mm	10	111M-11
12 mm	10	111M-12
13 mm	10	111M-13
14 mm	10	111M-14
15 mm	10	111M-15
16 mm	10	111M-16
17 mm	10	111M-17
18 mm	10	111M-18
19 mm	10	111M-19
20 mm	10	111M-20
21 mm	10	111M-21
22 mm	5	111M-22
23 mm	5	111M-23
24 mm	5	111M-24
25 mm	5	111M-25
26 mm	5	111M-26
27 mm	5	111M-27
28 mm	5	111M-28
29 mm	5	111M-29
30 mm	5	111M-30
32 mm	5	111M-32
33 mm	5	111M-33
34 mm	5	111M-34
36 mm	1	111M-36
38 mm	1	111M-38
41 mm	1	111M-41
46 mm	1	111M-46
50 mm	1	111M-50
55 mm	1	111M-55
60 mm	1	111M-60
65 mm	1	111M-65
70 mm	1	111M-70
75 mm	1	111M-75
80 mm	1	111M-80
85 mm	1	111M-85
90 mm	1	111M-90
95 mm	1	111M-95
100 mm	1	111M-100
5.5 mm	1	SB111M-5.5
6 mm	1	SB111M-6
7 mm	1	SB111M-7
8 mm	1	SB111M-8
9 mm	1	SB111M-9
10 mm	1	SB111M-10
11 mm	1	SB111M-11
12 mm	1	SB111M-12
13 mm	1	SB111M-13
14 mm	1	SB111M-14
15 mm	1	SB111M-15

  	
16 mm	1 SB111M-16
17 mm	1 SB111M-17
18 mm	1 SB111M-18
19 mm	1 SB111M-19
20 mm	1 SB111M-20
21 mm	1 SB111M-21
22 mm	1 SB111M-22
23 mm	1 SB111M-23
24 mm	1 SB111M-24
25 mm	1 SB111M-25
26 mm	1 SB111M-26
27 mm	1 SB111M-27
28 mm	1 SB111M-28
29 mm	1 SB111M-29
30 mm	1 SB111M-30
32 mm	1 SB111M-32

U-ringnyckel, kort modell, med förkromad yta, tum-dimensioner





1Z

  	
3/16 in	20 1Z-3/16
7/32 in	20 1Z-7/32
9/32 in	20 1Z-9/32
5/16 in	10 1Z-5/16
11/32 in	10 1Z-11/32
3/8 in	10 1Z-3/8
7/16 in	10 1Z-7/16
1/2 in	10 1Z-1/2
9/16 in	10 1Z-9/16
5/8 in	10 1Z-5/8
11/16 in	10 1Z-11/16
3/4 in	10 1Z-3/4
13/16 in	10 1Z-13/16
7/8 in	10 1Z-7/8
15/16 in	5 1Z-15/16
1 in	10 1Z-1

Platta u-ringnycklar, förkromade, tum-dimensioner





111Z

  	
1/4 in	5 111Z-1/4
5/16 in	5 111Z-5/16
3/8 in	5 111Z-3/8
7/16 in	5 111Z-7/16
1/2 in	5 111Z-1/2
9/16 in	5 111Z-9/16
5/8 in	5 111Z-5/8
11/16 in	5 111Z-11/16
3/4 in	5 111Z-3/4
13/16 in	5 111Z-13/16
7/8 in	5 111Z-7/8
15/16 in	3 111Z-15/16
1 in	3 111Z-1
1 1/16 in	5 111Z-1.1/16
1 1/8 in	5 111Z-1.1/8
1 1/4 in	5 111Z-1.1/4
1 5/16 in	5 111Z-1.5/16
1 3/8 in	1 111Z-1.3/8
1 7/16 in	1 111Z-1.7/16
1 1/2 in	1 111Z-1.1/2
1 5/8 in	1 111Z-1.5/8
1 11/16 in	1 111Z-1.11/16
1 3/4 in	1 111Z-1.3/4
1 13/16 in	1 111Z-1.13/16
1 7/8 in	1 111Z-1.7/8
2 in	1 111Z-2
2 1/8 in	1 111Z-2.1/8
2 1/4 in	1 111Z-2.1/4
2 3/8 in	1 111Z-2.3/8
2 1/2 in	1 111Z-2.1/2
2 5/8 in	1 111Z-2.5/8
2 3/4 in	1 111Z-2.3/4
2 7/8 in	1 111Z-2.7/8
3 in	1 111Z-3

Metrisk u-ringnycklar med mattförkromad yta





S20

  	
7	1 SBS20-7
8	1 SBS20-8
9	1 SBS20-9
11	1 SBS20-11
12	1 SBS20-12
13	1 SBS20-13
14	1 SBS20-14
15	1 SBS20-15
16	1 SBS20-16
20	1 SBS20-20
22	1 SBS20-22
24	1 SBS20-24

Sats med platta metriska u-ringnycklar-5 delar



111M/SH5



  	
5	1 111M/SH5

111M-8, 111M-10, 111M-13, 111M-17, 111M-19

Sats med platta u-ringnycklar i metriska dimensioner-8 delar



111M/SH8



  	
8	1 111M/SH8

111M-8, 111M-10, 111M-12, 111M-13, 111M-14, 111M-17, 111M-19, 111M-22

Sats med metrisk u-ringnycklar 9-18 mm-12 delar/plasthållare



111M/SH12

  	
12	1 111M/SH12

111M-8, 111M-9, 111M-10, 111M-11, 111M-12, 111M-13, 111M-14, 111M-15, 111M-16, 111M-17, 111M-18, 111M-19



Sats med platta u-ringnycklar i kartong



111M/



10

1 111M/S10

111M-8, 111M-9, 111M-10, 111M-11, 111M-12, 111M-13, 111M-14, 111M-17, 111M-19, 111M-22



Sats med metriska u-ringnycklar-11 delar/etui



111M/11T



11

1 111M/11T

111M-8, 111M-9, 111M-10, 111M-11, 111M-12, 111M-13, 111M-14, 111M-15, 111M-17, 111M-19, 111M-22



Sats med metriska u-ringnycklar-14 delar/etui



111M/14T



14

1 111M/14T

111M-6, 111M-8, 111M-9, 111M-10, 111M-13, 111M-14, 111M-15, 111M-17, 111M-19, 111M-22, 111M-24, 111M-27, 111M-30, 111M-32



Sats med metriska u-ringnycklar 6-22 mm-17 delar/etui



111M/17T



17

1 111M/17T

111M-6, 111M-7, 111M-8, 111M-9, 111M-10, 111M-11, 111M-12, 111M-13, 111M-14, 111M-15, 111M-16, 111M-17, 111M-18, 111M-19, 111M-20, 111M-21, 111M-22



Sats med metriska u-ringnycklar 8-32 mm-17 delar



111M/17TL



17

1 111M/17TL

111M-8, 111M-9, 111M-10, 111M-11, 111M-12, 111M-13, 111M-14, 111M-15, 111M-16, 111M-18, 111M-19, 111M-22, 111M-24, 111M-26, 111M-27, 111M-30, 111M-32



Sats med metriska u-ringnycklar-24 delar/etui



111M/24T



24

1 111M/24T

111M-6, 111M-7, 111M-8, 111M-9, 111M-10, 111M-11, 111M-12, 111M-13, 111M-14, 111M-15, 111M-16, 111M-17, 111M-18, 111M-19, 111M-20, 111M-21, 111M-22, 111M-24, 111M-26, 111M-27, 111M-28, 111M-30, 111M-32, 111M-36



Sats med metriska u-ringnycklar-26 delar/etui



111M/26T



26

1 111M/26T

111M-6, 111M-7, 111M-8, 111M-9, 111M-10, 111M-11, 111M-12, 111M-13, 111M-14, 111M-15, 111M-16, 111M-17, 111M-18, 111M-19, 111M-20, 111M-21, 111M-22, 111M-23, 111M-24, 111M-25, 111M-26, 111M-27, 111M-28, 111M-29, 111M-30, 111M-32



Sats med platta u-ringnycklar, tumdimensioner-8 delar



111Z/



8

1 111Z/8T

111Z-3/8, 111Z-7/16, 111Z-1/2,
111Z-9/16, 111Z-5/8, 111Z-11/16,
111Z-3/4, 111Z-7/8



U-ringnyckelsats, platt modell i tum-
storlekar-11 delar/plastetui



111Z/11T



11

1 111Z/11T

111Z-3/8, 111Z-7/16, 111Z-1/2,
111Z-9/16, 111Z-5/8, 111Z-11/16,
111Z-3/4, 111Z-13/16, 111Z-7/8,
111Z-15/16, 111Z-1



Metrisk, långa u-ringnycklar, förkromade



11M



8 mm	5	11M-8
9 mm	5	11M-9
10 mm	5	11M-10
11 mm	5	11M-11
12 mm	5	11M-12
13 mm	5	11M-13
14 mm	5	11M-14
15 mm	5	11M-15
16 mm	5	11M-16
17 mm	5	11M-17
18 mm	5	11M-18
19 mm	5	11M-19
21 mm	5	11M-21
22 mm	5	11M-22
24 mm	5	11M-24
27 mm	1	11M-27
30 mm	1	11M-30
32 mm	1	11M-32
36 mm	1	11M-36
38 mm	1	11M-38

Lång u-ringnyckel, förkromad, tum-
dimensioner



11Z



3/8 in	5	11Z-3/8
7/16 in	5	11Z-7/16
1/2 in	5	11Z-1/2
9/16 in	5	11Z-9/16
5/8 in	5	11Z-5/8
11/16 in	5	11Z-11/16
3/4 in	5	11Z-3/4
13/16 in	5	11Z-13/16
1 in	5	11Z-1

Metrisk u-ringnycklar, förkromade



4020L-M



3 mm	5	4020L-M-3
3.2 mm	5	4020L-M-3.2
3.5 mm	5	4020L-M-3.5
4 mm	5	4020L-M-4
4.5 mm	5	4020L-M-4.5
5 mm	5	4020L-M-5
5.5 mm	5	4020L-M-5.5

Metrisk, bockade u-ringnycklar,
förkromade



1952M



6 mm	10	1952M-6
7 mm	10	1952M-7
8 mm	10	1952M-8
9 mm	10	1952M-9
10 mm	10	1952M-10
11 mm	10	1952M-11
12 mm	10	1952M-12
13 mm	10	1952M-13
14 mm	10	1952M-14
15 mm	10	1952M-15
16 mm	10	1952M-16



17 mm	10	1952M-17
18 mm	10	1952M-18
19 mm	10	1952M-19
20 mm	10	1952M-20
21 mm	10	1952M-21
22 mm	5	1952M-22
23 mm	5	1952M-23
24 mm	5	1952M-24
25 mm	5	1952M-25
26 mm	5	1952M-26
27 mm	5	1952M-27
28 mm	1	1952M-28
29 mm	1	1952M-29
30 mm	1	1952M-30
32 mm	1	1952M-32
34 mm	1	1952M-34
36 mm	1	1952M-36
41 mm	1	1952M-41
46 mm	1	1952M-46
50 mm	1	1952M-50
55 mm	1	1952M-55
60 mm	1	1952M-60
65 mm	1	1952M-65
70 mm	1	1952M-70
75 mm	1	1952M-75
80 mm	1	1952M-80
7 mm	1	SB1952M-7
8 mm	1	SB1952M-8
10 mm	1	SB1952M-10
12 mm	1	SB1952M-12
13 mm	1	SB1952M-13
14 mm	1	SB1952M-14
17 mm	1	SB1952M-17
19 mm	1	SB1952M-19
24 mm	1	SB1952M-24

U-ringnycklar, förkromade, tum-
dimensioner



1952Z



1/4 in	5	1952Z-1/4
5/16 in	5	1952Z-5/16
11/32 in	5	1952Z-11/32
3/8 in	5	1952Z-3/8
7/16 in	5	1952Z-7/16
1/2 in	5	1952Z-1/2
9/16 in	5	1952Z-9/16
5/8 in	5	1952Z-5/8
11/16 in	5	1952Z-11/16
3/4 in	5	1952Z-3/4
13/16 in	5	1952Z-13/16
7/8 in	5	1952Z-7/8
15/16 in	5	1952Z-15/16
1 in	1	1952Z-1
1 1/16 in	1	1952Z-1.1/16
1 1/8 in	1	1952Z-1.1/8
1 1/4 in	1	1952Z-1.1/4
1 5/16 in	1	1952Z-1.5/16
1 3/8 in	1	1952Z-1.3/8
1 7/16 in	1	1952Z-1.7/16
1 1/2 in	1	1952Z-1.1/2
1 5/8 in	1	1952Z-1.5/8



Metrisk u-ringnyckel med 12-kants Dynamic-Drive™-profil i ringen



PU

6 mm	5 PU-6
9 mm	5 PU-9
14 mm	5 PU-14
20 mm	3 PU-20
22 mm	3 PU-22
24 mm	3 PU-24

Sats med metrisk u-ringnycklar, 10 delar



1952M/

10	1 1952M/10

1952M-8, 1952M-9, 1952M-10, 1952M-11, 1952M-12, 1952M-13, 1952M-14, 1952M-16, 1952M-17, 1952M-19

Sats med metrisk u-ringnycklar, 17 delar



1952M/17T

17	1 1952M/17T

1952M-6, 1952M-7, 1952M-8, 1952M-9, 1952M-10, 1952M-11, 1952M-12, 1952M-13, 1952M-14, 1952M-15, 1952M-16, 1952M-17, 1952M-18, 1952M-19, 1952M-20, 1952M-21, 1952M-22

Sats med metrisk u-ringnycklar, 8 delar



1952M/SH

6	1 1952M/SH6

1952M-8, 1952M-10, 1952M-12, 1952M-13, 1952M-14, 1952M-17

Sats med metrisk u-ringnycklar, 7 delar/etui



1952M/T

7	1 1952M/7T

1952M-8, 1952M-10, 1952M-13, 1952M-14, 1952M-17, 1952M-19, 1952M-22

Sats med metrisk u-ringnycklar, 12 delar



1952M/SH12

12	1 1952M/SH12

1952M-8, 1952M-9, 1952M-10, 1952M-11, 1952M-12, 1952M-13, 1952M-14, 1952M-15, 1952M-16, 1952M-17, 1952M-18, 1952M-19

Sats med metrisk u-ringnycklar, 14 delar



1952M/14T

14	1 1952M/14T

1952M-6, 1952M-8, 1952M-9, 1952M-10, 1952M-13, 1952M-14, 1952M-15, 1952M-17, 1952M-19, 1952M-22, 1952M-24, 1952M-27, 1952M-30, 1952M-32

Sats med metrisk u-ringnycklar, 26 delar



1952M/26T

26	1 1952M/26T

1952M-6, 1952M-7, 1952M-8, 1952M-9, 1952M-10, 1952M-11, 1952M-12, 1952M-13, 1952M-14, 1952M-15, 1952M-16, 1952M-17, 1952M-18, 1952M-19, 1952M-20, 1952M-21, 1952M-22, 1952M-23, 1952M-24, 1952M-25, 1952M-26, 1952M-27, 1952M-28, 1952M-29, 1952M-30, 1952M-32

Sats med u-ringnycklar, tum-dimensioner



1952Z/T

11	1	1952Z/11T

1952Z-1/4, 1952Z-5/16, 1952Z-3/8, 1952Z-7/16, 1952Z-1/2, 1952Z-9/16, 1952Z-5/8, 1952Z-11/16, 1952Z-3/4, 1952Z-13/16, 1952Z-7/8

SPÄRRNYCKLAR

Metrisk spärkombinycklar, förkromade



1RM

6 mm	1	1RM-6
7 mm	1	1RM-7
8 mm	1	1RM-8
9 mm	1	1RM-9
10 mm	1	1RM-10
11 mm	1	1RM-11
12 mm	1	1RM-12
13 mm	1	1RM-13
14 mm	1	1RM-14
15 mm	1	1RM-15
16 mm	1	1RM-16
17 mm	1	1RM-17
18 mm	1	1RM-18
19 mm	1	1RM-19
21 mm	1	1RM-21
22 mm	1	1RM-22
24 mm	1	1RM-24
27 mm	1	1RM-27
30 mm	1	1RM-30
32 mm	1	1RM-32

Spärkombinyckel, förkromad, tum-dimensioner



1RZ

1/4 in	1	1RZ-1/4
5/16 in	1	1RZ-5/16
11/32 in	1	1RZ-11/32
3/8 in	1	1RZ-3/8
7/16 in	1	1RZ-7/16
1/2 in	1	1RZ-1/2
9/16 in	1	1RZ-9/16
5/8 in	1	1RZ-5/8
11/16 in	1	1RZ-11/16
3/4 in	1	1RZ-3/4
7/8 in	1	1RZ-7/8
15/16 in	1	1RZ-15/16

Kort spärkombinyckel, förkromad, metrisk



10RM

8 mm	1	10RM-8
10 mm	1	10RM-10
13 mm	1	10RM-13
14 mm	1	10RM-14
17 mm	1	10RM-17
19 mm	1	10RM-19

Kort spärkombinyckel, förkromad, tum-dimensioner



10RZ

5/16 in	1	10RZ-5/16
3/8 in	1	10RZ-3/8
7/16 in	1	10RZ-7/16



1/2 in	1	10RZ-1/2
9/16 in	1	10RZ-9/16
5/8 in	1	10RZ-5/8
11/16 in	1	10RZ-11/16
3/4 in	1	10RZ-3/4

Metrisk spärkombinycklar med ledat huvud, förkromade



41RM

8 mm	1	41RM-8
10 mm	1	41RM-10
11 mm	1	41RM-11
12 mm	1	41RM-12
13 mm	1	41RM-13
14 mm	1	41RM-14
17 mm	1	41RM-17
19 mm	1	41RM-19
21 mm	1	41RM-21

Ledade spärkombinycklar i tum-dimensioner, med förkromad yta



41RZ

5/16 in	1	41RZ-5/16
3/8 in	1	41RZ-3/8
7/16 in	1	41RZ-7/16
1/2 in	1	41RZ-1/2
9/16 in	1	41RZ-9/16
5/8 in	1	41RZ-5/8
11/16 in	1	41RZ-11/16
3/4 in	1	41RZ-3/4
13/16 in	1	41RZ-13/16
7/8 in	1	41RZ-7/8



Sats med metrisk spärkombinycklar 6 delar/plasthållare



1RM/



6

1 1RM/SH6

1RM-8, 1RM-10, 1RM-12, 1RM-13, 1RM-14, 1RM-17



Sats med metrisk spärkombinycklar 5 delar/plastlåda



1RM/S5



5

10 1RM/S5

1RM-8, 1RM-10, 1RM-13, 1RM-17, 1RM-19



Satser med spärkombinycklar, kort modell



10RM/



6

1 10RM/SH6

10RM-8, 10RM-10, 10RM-13, 10RM-14, 10RM-17, 10RM-19



Sats med metrisk spärkombinycklar 8 delar/plasthållare



1RM/SH8



8

1 1RM/SH8

1RM-8, 1RM-10, 1RM-11, 1RM-12, 1RM-13, 1RM-14, 1RM-17, 1RM-19



Spärkombinyckelsats, tum-storlekar, i plasthållare



1RZ/



8

1 1RZ/SH8

1RZ-5/16, 1RZ-3/8, 1RZ-7/16, 1RZ-1/2, 1RZ-9/16, 1RZ-5/8, 1RZ-11/16, 1RZ-3/4



Sats med spärkombinycklar med ledat huvud, metrisk dimensioner, i plasthållare



41RM/SH8



8

10 41RM/SH8

41RM-8, 41RM-10, 41RM-11, 41RM-12, 41RM-13, 41RM-14, 41RM-17, 41RM-19



Sats med metrisk spärkombinycklar 12 delar/plasthållare



1RM/SH12



12

10 1RM/SH12

1RM-8, 1RM-9, 1RM-10, 1RM-11, 1RM-12, 1RM-13, 1RM-14, 1RM-15, 1RM-16, 1RM-17, 1RM-18, 1RM-19



Sats med spärkombinyckel och mellanstycken



1RMA/S8



160 x 283 x 75 mm

1 1RMA/S8

1RMA-13-3/8-SQ, 1RMA-10-1/4-SQ, 1RMA-19-1/2-SQ



1RMA-13-5/16-BIT, 1RMA-10-1/4-BIT



1RM-13, 1RM-10, 1RM-19

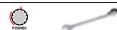

Sats med spärringnycklar



42RM/S12



g



229 x 70 x 280 mm

1562 g

1 42RM/S12

72 teeth / 5° action angle ratchet with 12 faced inserts

Metrisk spärringnyckel, förkromad



1320RM

6-7 mm	1	1320RM-6-7
8-9 mm	1	1320RM-8-9
10-11 mm	1	1320RM-10-11
12-13 mm	1	1320RM-12-13
14-15 mm	1	1320RM-14-15
16-17 mm	1	1320RM-16-17
17-19 mm	1	1320RM-17-19
18-19 mm	1	1320RM-18-19
22-24 mm	1	1320RM-22-24

Spärringnyckel, förkromad, tum-dimensioner



1320RZ

1/4-5/16" in	1	1320RZ-1/4-5/16
5/16-11/32 in	60	1320RZ-5/16-11/32
3/8-7/16" in	1	1320RZ-3/8-7/16
1/2-9/16" in	1	1320RZ-1/2-9/16
5/8-11/16" in	1	1320RZ-5/8-11/16
3/4-13/16" in	1	1320RZ-3/4-13/16
3/4-7/8" in	1	1320RZ-3/4-7/8
7/8-15/16" in	1	1320RZ-7/8-15/16

Spärringnyckel med vinklat huvud, förkromad, tum-dimensioner



1321RZ

3/8-7/16 in	1	1321RZ-3/8-7/16
1/2-9/16 in	1	1321RZ-1/2-9/16
5/8-11/16 in	1	1321RZ-5/8-11/16
3/4x7/8 in	1	1321RZ-3/4-7/8

S-formad spärringnyckel, förkromad



1320SRM

14-19 mm	1	1320SRM-14-19

Metrisk spärringnyckelsats



1320RM/

8	1	1320RM/SH8

1320RM-6-7, 1320RM-8-9, 1320RM-10-11, 1320RM-12-13, 1320RM-14-15, 1320RM-16-17, 1320RM-18-19, 1320RM-22-24

Sats med s-formad spärringnyckel och adapterar



1320SRM/

29	1	1320SRM/S29

1320SRM-14-19
1RMA-19-1/4-SQ
SBS19-TH22

4-i-1 spärringnycklar, förkromade



S4RM

4x5 6x7 mm	1	S4RM-4-7
8x9 10x11 mm	1	S4RM-8-11
12x13 14x15 mm	1	S4RM-12-15
16x17 18x19 mm	1	S4RM-16-19
20x21 24x27 mm	1	S4RM-21-27
30x32 34x36 mm	1	S4RM-30-36

4-i-1 sats med spärringnycklar-3 delar i etui



S4RM/

3	20	S4RM/3T

S4RM-8-11, S4RM-12-15, S4RM-16-19

4-i-1 sats med spärringnycklar-4 delar i etui



S4RM/4T

4	1	S4RM/4T

S4RM-8-11, S4RM-12-15, S4RM-16-19, S4RM-21-27



4-i-1 sats med spärringnycklar-4 delar i etui



S4RM/5T



5

1 S4RM/5T

S4RM-8-11, S4RM-12-15, S4RM-16-19, S4RM-21-27, S4RM-30-36



Bitshylsa och bitsadapter för spärrnyckel



1RMA-SQ



1/4 in	10 mm	1	1RMA-10-1/4-SQ
3/8 in	13 mm	1	1RMA-13-3/8-SQ
1/2 in	19 mm	1	1RMA-19-1/2-SQ
1/4 in	19 mm	1	1RMA-19-1/4-SQ

Mellanstycke för spärrnyckel för 1/4" och 5/16" bits



1RMA-BIT



1/4	10 mm	1	1RMA-10-1/4-BIT
5/16	13 mm	1	1RMA-13-5/16-BIT
10	13 mm	1	1RMA-13-10-BIT

Sats med mellanstycken för spärrnycklar



1RMA/S4



84 x 100 x 35 mm

1 1RMA/S4

1RMA-10-1/4-SQ, 1RMA-19-1/2-SQ, 1RMA-13-3/8-SQ



1RMA-10-1/4-BIT



U-NYCKLAR

Metrisk dubbla u-nycklar, förkromade



6M



4x5 mm	10	6M-4-5
4.5x5.5 mm	10	6M-4.5-5.5
5x5.5 mm	10	6M-5-5.5
5.5x7 mm	10	6M-5.5-7
6x7 mm	10	6M-6-7
7x8 mm	10	6M-7-8
8x9 mm	10	6M-8-9
8x10 mm	10	6M-8-10
10x11 mm	10	6M-10-11
10x13 mm	10	6M-10-13
12x13 mm	10	6M-12-13
12x14 mm	10	6M-12-14
13x14 mm	10	6M-13-14
13x15 mm	10	6M-13-15
13x16 mm	10	6M-13-16
13x17 mm	10	6M-13-17
14x15 mm	10	6M-14-15
14x17 mm	10	6M-14-17
16x17 mm	10	6M-16-17
16x18 mm	10	6M-16-18
17x19 mm	10	6M-17-19
18x19 mm	10	6M-18-19
19x22 mm	10	6M-19-22
19x24 mm	10	6M-19-24
20x22 mm	10	6M-20-22
21x23 mm	10	6M-21-23
21x24 mm	10	6M-21-24
22x24 mm	10	6M-22-24



24x26 mm	10	6M-24-26
24x27 mm	10	6M-24-27
24x30 mm	5	6M-24-30
25x28 mm	5	6M-25-28
27x29 mm	5	6M-27-29
27x30 mm	5	6M-27-30
27x32 mm	5	6M-27-32
30x32 mm	5	6M-30-32
30x36 mm	5	6M-30-36
32x36 mm	5	6M-32-36
34x36 mm	1	6M-34-36
36x41 mm	1	6M-36-41
38x42 mm	1	6M-38-42
41x46 mm	1	6M-41-46
46x50 mm	1	6M-46-50
4x5 mm	1	SB6M-4-5
6x7 mm	1	SB6M-6-7
8x9 mm	1	SB6M-8-9
10x11 mm	1	SB6M-10-11
12x13 mm	1	SB6M-12-13
14x15 mm	1	SB6M-14-15
16x17 mm	1	SB6M-16-17
17x19 mm	1	SB6M-17-19
18x19 mm	1	SB6M-18-19
20x22 mm	1	SB6M-20-22
21x23 mm	1	SB6M-21-23
22x24 mm	1	SB6M-22-24
24x26 mm	1	SB6M-24-26
24x27 mm	1	SB6M-24-27
25x28 mm	1	SB6M-25-28
27x29 mm	1	SB6M-27-29
30x32 mm	1	SB6M-30-32

Dubbla förkromade nycklar i tumdimensioner



6Z



1/4x5/16 in	5	6Z-1/4-5/16
5/16x11/32 in	5	6Z-5/16-11/32
3/8x7/16 in	5	6Z-3/8-7/16
7/16x1/2 in	5	6Z-7/16-1/2
1/2x9/16 in	5	6Z-1/2-9/16
9/16x5/8 in	5	6Z-9/16-5/8
19/32x11/16 in	5	6Z-19/32-11/16
5/8x3/4 in	5	6Z-5/8-3/4
11/16x3/4 in	5	6Z-11/16-3/4
3/4x7/8 in	5	6Z-3/4-7/8
25/32x13/16 in	5	6Z-25/32-13/16
13/16x7/8 in	5	6Z-13/16-7/8
7/8x15/16 in	5	6Z-7/8-15/16
15/16x1 in	5	6Z-15/16-1
1x1.1/8 in	1	6Z-1-1.1/8
1.1/16x1.1/4 in	1	6Z-1.1/16-1.1/4
1.1/4x1.3/8 in	1	6Z-1.1/4-1.3/8

Små förkromade dubbla u-nycklar, metrisk



1931M

Wrench Size	Quantity	Part Number
4 mm	5	1931M-4
4.5 mm	5	1931M-4.5
5 mm	5	1931M-5
5.5 mm	5	1931M-5.5
6 mm	5	1931M-6
7 mm	5	1931M-7
8 mm	5	1931M-8
9 mm	5	1931M-9
10 mm	5	1931M-10
11 mm	5	1931M-11
12 mm	5	1931M-12
13 mm	5	1931M-13
14 mm	5	1931M-14
17 mm	5	1931M-17

Små förkromade dubbla u-nycklar, tum-dimensioner



1931Z

Wrench Size	Length (mm)	Quantity	Part Number
1/8 in	74 mm	5	1931Z-1/8
5/32 in	80 mm	5	1931Z-5/32
3/16 in	80 mm	5	1931Z-3/16
13/64 in	80 mm	5	1931Z-13/64
7/32 in	80 mm	5	1931Z-7/32
15/64x1/4 in	84 mm	5	1931Z-15/64-1/4
1/4 in	80 mm	5	1931Z-1/4
9/32 in	90 mm	5	1931Z-9/32
9/32x5/16 in	94 mm	5	1931Z-9/32-5/16
5/16 in	90 mm	5	1931Z-5/16
11/32 in	105 mm	5	1931Z-11/32
11/32x3/8 in	94 mm	5	1931Z-11/32-3/8
3/8 in	105 mm	5	1931Z-3/8
7/16 in	120 mm	5	1931Z-7/16
1/2 in	120 mm	5	1931Z-1/2
9/16 in	130 mm	5	1931Z-9/16
5/8 in	130 mm	5	1931Z-5/8

Metrisk dubbel u-nyckel med svartoxiderad yta



895M

Wrench Size	Length (mm)	Quantity	Part Number
6x7 mm	96 mm	10	895M-6-7
8x9 mm	109 mm	10	895M-8-9
8x10 mm	115 mm	10	895M-8-10
10x11 mm	124 mm	10	895M-10-11
10x13 mm	110 mm	10	895M-10-13
13x17 mm	155 mm	10	895M-13-17
17x19 mm	172 mm	10	895M-17-19
19x22 mm	195 mm	10	895M-19-22
19x24 mm	206 mm	5	895M-19-24
22x24 mm	220 mm	5	895M-22-24
24x27 mm	244 mm	5	895M-24-27
24x30 mm	265 mm	5	895M-24-30
27x32 mm	270 mm	5	895M-27-32
30x32 mm	275 mm	5	895M-30-32
30x36 mm	305 mm	1	895M-30-36
32x36 mm	307 mm	1	895M-32-36
36x41 mm	345 mm	1	895M-36-41
41x46 mm	381 mm	1	895M-41-46
46x50 mm	420 mm	1	895M-46-50
50x55 mm	460 mm	1	895M-50-55
55x60 mm	500 mm	1	895M-55-60
65x70 mm	580 mm	1	895M-65-70

Sats med metrisk dubbla u-nycklar, 8 delar



6M/SH

Wrench Size	Quantity	Part Number
8	1	6M/SH8

6M-6-7, 6M-8-9, 6M-10-11, 6M-12-13, 6M-14-15, 6M-16-17, 6M-18-19, 6M-20-22

Sats med metrisk dubbla u-nycklar, 12 delar



6M/SH12

Wrench Size	Quantity	Part Number
12	1	6M/SH12

6M-6-7, 6M-8-9, 6M-10-11, 6M-12-13, 6M-14-15, 6M-16-17, 6M-18-19, 6M-20-22, 6M-21-23, 6M-24-26, 6M-25-28, 6M-30-32

Sats med metrisk dubbla u-nycklar, 8 delar



6M/S

Wrench Size	Quantity	Part Number
8	1	6M/S8

6M-6-7, 6M-8-9, 6M-10-11, 6M-12-13, 6M-14-15, 6M-16-17, 6M-18-19, 6M-20-22

Sats med metrisk dubbla u-nycklar, 6 delar



6M/6C

Wrench Size	Quantity	Part Number
6	1	6M/6C

6M-6-7, 6M-8-9, 6M-10-11, 6M-12-13, 6M-14-15, 6M-16-17



Sats med metriska dubbla u-nycklar 8 delar i plasthållare



6M/8C



8

1 6M/8C

6M-6-7, 6M-8-9, 6M-10-11, 6M-12-13, 6M-14-15, 6M-16-17, 6M-18-19, 6M-20-22

Sats med dubbla u-nycklar 10 delar i plastklämma



6M/10C



10

1 6M/10C

6M-6-7, 6M-8-9, 6M-10-11, 6M-12-13, 6M-14-15, 6M-16-17, 6M-18-19, 6M-20-22, 6M-24-27, 6M-30-32

Sats med metriska dubbla u-nycklar 12 delar i plasthållare



6M/12C



12

1 6M/12C

6M-6-7, 6M-8-9, 6M-10-11, 6M-12-13, 6M-14-15, 6M-16-17, 6M-18-19, 6M-20-22, 6M-21-23, 6M-24-27, 6M-25-28, 6M-30-32

Sats med dubbla u-nycklar, tumdimensioner



6Z/



8

1 6Z/8C

6Z-1/4-5/16, 6Z-3/8-7/16, 6Z-5/16-11/32, 6Z-1/2-9/16, 6Z-19/32-11/16, 6Z-5/8-3/4, 6Z-13/16-7/8, 6Z-15/16-1

Sats med små metriska dubbla u-nycklar



1931M/



10

1 1931M/10T

1931M-4, 1931M-4.5, 1931M-5, 1931M-5.5, 1931M-6, 1931M-7, 1931M-8, 1931M-9, 1931M-10, 1931M-11

Sats med små dubbla u-nycklar, tumdimensioner



1931Z/



12

1 1931Z/12T

1931Z-5/32, 1931Z-9/32, 1931Z-5/16, 1931Z-11/32, 1931Z-3/8, 1931Z-3/16, 1931Z-7/32, 1931Z-1/4, 1931Z-7/16, 1931Z-1/2, 1931Z-5/8, 1931Z-9/16

Sats med metriska dubbla u-nycklar



1933M/

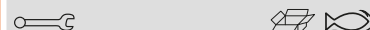

6

1 1933M/6T

4x4, 4.5x4.5, 5x5, 5.5x5.5, 6x6, 7x7

Sats med magnetiska u-nycklar på ring, metriska dimensioner



3280M/

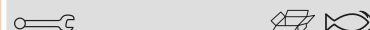

8

1 3280M

4, 4.5, 5, 5.5, 6, 6.5, 7, 7.5 mm

Tuppöfotsnyckel 1/4" med fyrkantfäste



677-



7 mm	1/4 in	1 677-7
8 mm	1/4 in	1 677-8
9 mm	1/4 in	1 677-9
10 mm	1/4 in	1 677-10
13 mm	1/4 in	1 677-13
3/8 in	1/4 in	1 677-3/8

Tuppfotsnyckel med 3/8" invändigt fyrkantfäste



747-



mm	in	1	747-
10 mm	3/8 in	1	747-10
11 mm	3/8 in	1	747-11
12 mm	3/8 in	1	747-12
13 mm	3/8 in	1	747-13
14 mm	3/8 in	1	747-14
15 mm	3/8 in	1	747-15
16 mm	3/8 in	1	747-16
17 mm	3/8 in	1	747-17
18 mm	3/8 in	1	747-18
19 mm	3/8 in	1	747-19
20 mm	3/8 in	1	747-20
21 mm	3/8 in	1	747-21
22 mm	3/8 in	1	747-22
23 mm	3/8 in	1	747-23
24 mm	3/8 in	1	747-24
25 mm	3/8 in	1	747-25
26 mm	3/8 in	1	747-26
27 mm	3/8 in	1	747-27
28 mm	3/8 in	1	747-28
30 mm	3/8 in	1	747-30
32 mm	3/8 in	1	747-32
34 mm	3/8 in	1	747-34
36 mm	3/8 in	1	747-36
40 mm	3/8 in	1	747-40
41 mm	3/8 in	1	747-41
42 mm	3/8 in	1	747-42
46 mm	3/8 in	1	747-46
50 mm	3/8 in	1	747-50
3/8 in	3/8 in	1	747-3/8
7/16 in	3/8 in	1	747-7/16
1/2 in	3/8 in	1	747-1/2
9/16 in	3/8 in	1	747-9/16
5/8 in	3/8 in	1	747-5/8
11/16 in	3/8 in	1	747-11/16
3/4 in	3/8 in	1	747-3/4
13/16 in	3/8 in	1	747-13/16
7/8 in	3/8 in	1	747-7/8
15/16 in	3/8 in	1	747-15/16
1 in	3/8 in	1	747-1
1.1/16 in	3/8 in	1	747-1.1/16
1.1/8 in	3/8 in	1	747-1.1/8
1.3/16 in	3/8 in	1	747-1.3/16
1.1/4 in	3/8 in	1	747-1.1/4
1.5/16 in	3/8 in	1	747-1.5/16
1.3/8 in	3/8 in	1	747-1.3/8
1.7/16 in	3/8 in	1	747-1.7/16
1.1/2 in	3/8 in	1	747-1.1/2
1.9/16 in	3/8 in	1	747-1.9/16
1.5/8 in	3/8 in	1	747-1.5/8
1.11/16 in	3/8 in	1	747-1.11/16
1.3/4 in	3/8 in	1	747-1.3/4
1.13/16 in	3/8 in	1	747-1.13/16
1.7/8 in	3/8 in	1	747-1.7/8
1.15/16 in	3/8 in	1	747-1.15/16
2 in	3/8 in	1	747-2
2.1/16 in	3/8 in	1	747-2.1/16
2.1/8 in	3/8 in	1	747-2.1/8

mm	in	1	747-
2.3/16 in	3/8 in	1	747-2.3/16
2.1/4 in	3/8 in	1	747-2.1/4
2.5/16 in	3/8 in	1	747-2.5/16
2.3/8 in	3/8 in	1	747-2.3/8
2.7/16 in	3/8 in	1	747-2.7/16
2.1/2 in	3/8 in	1	747-2.1/2
2.9/16 in	3/8 in	1	747-2.9/16
2.5/8 in	3/8 in	1	747-2.5/8
2.3/4 in	3/8 in	1	747-2.3/4
2.7/8 in	3/8 in	1	747-2.7/8

Tuppfotsnyckel 1/2" med invändigt fyrkantfäste



787-



mm	in	1	787-
1.1/16 in	1/2 in	1	787-1.1/16
1.1/8 in	1/2 in	1	787-1.1/8
1.3/16 in	1/2 in	1	787-1.3/16
1.1/4 in	1/2 in	1	787-1.1/4
1.5/16 in	1/2 in	1	787-1.5/16
1.3/8 in	1/2 in	1	787-1.3/8
1.7/16 in	1/2 in	1	787-1.7/16
1.1/2 in	1/2 in	1	787-1.1/2
1.5/8 in	1/2 in	1	787-1.5/8
1.11/16 in	1/2 in	1	787-1.11/16
1.3/4 in	1/2 in	1	787-1.3/4
1.13/16 in	1/2 in	1	787-1.13/16
1.7/8 in	1/2 in	1	787-1.7/8
2 in	1/2 in	1	787-2
2.1/8 in	1/2 in	1	787-2.1/8
2.3/16 in	1/2 in	1	787-2.3/16
2.1/4 in	1/2 in	1	787-2.1/4
2.3/8 in	1/2 in	1	787-2.3/8

Metrisk u-nyckel med svartoxiderad yta



894M

mm	mm	10	894M-
7 mm	78 mm	10	894M-7
8 mm	94 mm	10	894M-8
9 mm	100 mm	10	894M-9
10 mm	106 mm	10	894M-10

mm	mm	10	894M-
11 mm	112 mm	10	894M-11
12 mm	125 mm	10	894M-12
13 mm	125 mm	10	894M-13
14 mm	140 mm	10	894M-14
15 mm	140 mm	10	894M-15
16 mm	140 mm	10	894M-16
17 mm	158 mm	10	894M-17
19 mm	171 mm	10	894M-19
21 mm	195 mm	5	894M-21
22 mm	195 mm	5	894M-22
24 mm	216 mm	5	894M-24
27 mm	240 mm	5	894M-27
30 mm	262 mm	5	894M-30
32 mm	274 mm	5	894M-32
34 mm	274 mm	1	894M-34
36 mm	303 mm	5	894M-36
38 mm	305 mm	1	894M-38
41 mm	343 mm	1	894M-41
46 mm	378 mm	1	894M-46
50 mm	413 mm	1	894M-50
55 mm	457 mm	1	894M-55
60 mm	492 mm	1	894M-60
65 mm	528 mm	1	894M-65
70 mm	573 mm	1	894M-70
75 mm	608 mm	1	894M-75
80 mm	644 mm	1	894M-80
85 mm	690 mm	1	894M-85
90 mm	690 mm	1	894M-90
95 mm	850 mm	1	894M-95
100 mm	1000 mm	1	894M-100
105 mm	1000 mm	1	894M-105
110 mm	1000 mm	1	894M-110
115 mm	1000 mm	1	894M-115
120 mm	1000 mm	1	894M-120
125 mm	1000 mm	1	894M-125
130 mm	1000 mm	1	894M-130
135 mm	1000 mm	1	894M-135

Ställningsnyckel med svartoxiderad yta, i metrisk dimensioner



SC335M

mm	mm	1	SC335M-
17 mm	320 mm	1	SC335M-17
19 mm	350 mm	1	SC335M-19
22 mm	350 mm	1	SC335M-22
24 mm	370 mm	1	SC335M-24
27 mm	370 mm	1	SC335M-27
30 mm	400 mm	1	SC335M-30
32 mm	400 mm	1	SC335M-32
36 mm	430 mm	1	SC335M-36
41 mm	470 mm	1	SC335M-41
46 mm	500 mm	1	SC335M-46



RINGNYCKLAR

Metriskas bockade dubbla ringnycklar, förkromade



2M

Spårstorlek	Längd	Antal	Artikelnr
6x7 mm	165 mm	5	2M-6-7
8x9 mm	180 mm	5	2M-8-9
8x10 mm	180 mm	5	2M-8-10
10x11 mm	190 mm	5	2M-10-11
10x13 mm	190 mm	5	2M-10-13
12x13 mm	210 mm	5	2M-12-13
13x17 mm	243 mm	5	2M-13-17
14x15 mm	226 mm	5	2M-14-15
16x17 mm	246 mm	5	2M-16-17
16x18 mm	246 mm	5	2M-16-18
17x19 mm	266 mm	5	2M-17-19
18x19 mm	266 mm	5	2M-18-19
19x22 mm	291 mm	5	2M-19-22
20x22 mm	291 mm	5	2M-20-22
21x23 mm	306 mm	5	2M-21-23
22x24 mm	306 mm	5	2M-22-24
24x26 mm	326 mm	5	2M-24-26
24x27 mm	326 mm	5	2M-24-27
25x28 mm	336 mm	5	2M-25-28
27x29 mm	351 mm	5	2M-27-29
27x30 mm	351 mm	5	2M-27-30
27x32 mm	353 mm	5	2M-27-32
30x32 mm	362 mm	5	2M-30-32
32x36 mm	416 mm	1	2M-32-36
36x41 mm	444 mm	1	2M-36-41
41x46 mm	483 mm	1	2M-41-46
46x50 mm	541 mm	1	2M-46-50

Bockade dubbla ringnycklar, förkromade, tum-dimensioner



2Z

Spårstorlek	Längd	Antal	Artikelnr
1/4x5/16 in	165 mm	1	2Z-1/4-5/16
5/16x3/8 in	180 mm	1	2Z-5/16-3/8
3/8x7/16 in	190 mm	1	2Z-3/8-7/16
1/2x9/16 in	210 mm	1	2Z-1/2-9/16
9/16x5/8 in	225,8 mm	1	2Z-9/16-5/8

Spårstorlek	Längd	Antal	Artikelnr
5/8x11/16 in	245,5 mm	1	2Z-5/8-11/16
3/4x7/8 in	290,5 mm	1	2Z-3/4-7/8
13/16x7/8 in	290,5 mm	1	2Z-13/16-7/8
15/16x1 in	325,8 mm	1	2Z-15/16-1
1x1 1/8 in	335,9 mm	1	2Z-1-1.1/8
1 1/16x1 1/4 in	353 mm	1	2Z-1.1/16-1.1/4

Bockade dubbla ringnycklar, förkromade, tum-dimensioner



1300Z

Spårstorlek	Längd	Antal	Artikelnr
1/4x5/16 in	156 mm	1	1300Z-1/4-5/16
3/8x7/16 in	193 mm	1	1300Z-3/8-7/16
19/32x11/16 in	258 mm	1	1300Z-19/32-11/16
5/8x3/4 in	278 mm	1	1300Z-5/8-3/4
25/32x13/16 in	300 mm	1	1300Z-25/32-13/16
7/8x15/16 in	334 mm	1	1300Z-7/8-15/16
15/16x1 in	352 mm	1	1300Z-15/16-1
1x1.1/8 in	380 mm	1	1300Z-1-1.1/8

Sats med långa metriskas bockade dubbla ringnycklar, 8 delar



2M/S

Spårstorlek	Längd	Antal	Artikelnr
8 delar		1	2M/S8

2M-6-7, 2M-8-9, 2M-10-11, 2M-12-13, 2M-14-15, 2M-16-17, 2M-18-19, 2M-20-22

Sats med metriskas bockade dubbla ringnycklar, 8 delar



2M/T

Spårstorlek	Längd	Antal	Artikelnr
8 delar		1	2M/8T

2M-6-7, 2M-8-9, 2M-10-11, 2M-12-13, 2M-14-15, 2M-16-17, 2M-18-19, 2M-20-22

Sats med långa dubbla metriskas ringnycklar, bockade, 10 delar



2M/10T

Spårstorlek	Längd	Antal	Artikelnr
10 delar		1	2M/10T

2M-6-7, 2M-8-9, 2M-10-11, 2M-12-13, 2M-14-15, 2M-16-17, 2M-18-19, 2M-20-22, 2M-21-23, 2M-24-27

Sats med metriskas bockade dubbla ringnycklar-12 delar/etui



2M/12T

Spårstorlek	Längd	Antal	Artikelnr
12 delar		1	2M/12T

2M-6-7, 2M-8-9, 2M-10-11, 2M-12-13, 2M-14-15, 2M-16-17, 2M-18-19, 2M-20-22, 2M-21-23, 2M-24-27, 2M-25-28, 2M-30-32

Sats med bockade dubbla ringnycklar i tum-dimensioner, i svart plastetui



2Z/T

Diagram	Icon	Quantity	Part Number
		7	1 2Z/T

2Z-1/4-5/16, 2Z-5/16-3/8, 2Z-3/8-7/16, 2Z-1/2-9/16, 2Z-9/16-5/8, 2Z-5/8-11/16, 2Z-3/4-7/8

Dubbla ringnycklar med förkromad yta



4M

Diagram	L	Icon	Quantity	Part Number
	6x7 mm	95 mm	10	4M-6-7
	8x9 mm	110 mm	10	4M-8-9
	10x11 mm	125 mm	10	4M-10-11
	12x13 mm	140 mm	10	4M-12-13
	14x15 mm	155 mm	10	4M-14-15
	16x17 mm	170 mm	10	4M-16-17
	17x19 mm	170 mm	10	4M-17-19
	18x19 mm	185 mm	10	4M-18-19
	20x22 mm	205 mm	10	4M-20-22
	21x23 mm	225 mm	5	4M-21-23
	24x26 mm	250 mm	1	4M-24-26
	24x27 mm	255 mm	1	4M-24-27
	25x28 mm	275 mm	1	4M-25-28
	27x29 mm	275 mm	1	4M-27-29
	30x32 mm	300 mm	1	4M-30-32

Långa dubbla ringnycklar i tum-dimensioner



44Z

Diagram	L	Icon	Quantity	Part Number
	1/4x5/16 in	197 mm	10	44Z-1/4-5/16
	5/16x3/8 in	238 mm	10	44Z-5/16-3/8
	3/8x7/16 in	284 mm	10	44Z-3/8-7/16

Diagram	L	Icon	Quantity	Part Number
	7/16x1/2 in	326 mm	10	44Z-7/16-1/2
	1/2x9/16 in	358 mm	10	44Z-1/2-9/16
	5/8x3/4 in	401 mm	5	44Z-5/8-3/4
	11/16x3/4 in	401 mm	5	44Z-11/16-3/4
	11/16x13/16 in	410 mm	5	44Z-11/16-13/16

Metrisk startmotornyckel med dubbel ringnyckel



1943M

Diagram	L	Icon	Quantity	Part Number
	11x13 mm	150 mm	1	1943M-11-13
	13x15 mm	185 mm	1	1943M-13-15
	13x17 mm	185 mm	1	1943M-13-17
	14x16 mm	185 mm	1	1943M-14-16
	14x17 mm	185 mm	1	1943M-14-17
	15x17 mm	185 mm	1	1943M-15-17
	19x22 mm	235 mm	1	1943M-19-22

Startmotornyckel med dubbel ringnyckel, tum-dimensioner



1943Z

Diagram	L	Icon	Quantity	Part Number
	5/16x3/8 in	153 mm	1	1943Z-5/16-3/8
	7/16x1/2 in	153 mm	1	1943Z-7/16-1/2
	9/16x5/8 in	186 mm	1	1943Z-9/16-5/8
	5/8x3/4 in	233 mm	1	1943Z-5/8-3/4
	11/16x13/16 in	233 mm	1	1943Z-11/16-13/16

Sats med metriska dubbla ringnycklar i svart plasthållare



4M/T

Diagram	Icon	Quantity	Part Number
		10	1 4M/T

4M-6-7, 4M-8-9, 4M-10-11, 4M-12-13, 4M-14-15, 4M-16-17, 4M-18-19, 4M-20-22, 4M-24-27, 4M-30-32

Sats med metriska dubbla ringnycklar i grå plasthållare



4M/C

Diagram	Icon	Quantity	Part Number
		10	1 4M/C

4M-6-7, 4M-8-9, 4M-10-11, 4M-12-13, 4M-14-15, 4M-16-17, 4M-18-19, 4M-20-22, 4M-21-23, 4M-24-27

Sats med metriska dubbla ringnycklar



4M/12C

Diagram	Icon	Quantity	Part Number
		12	1 4M/12C

4M-6-7, 4M-8-9, 4M-10-11, 4M-12-13, 4M-14-15, 4M-16-17, 4M-18-19, 4M-20-22, 4M-21-23, 4M-24-27, 4M-25-28, 4M-30-32



Sats med metriska dubbla ringnycklar, i kartong



4M/

8	1	4M/8

4M-6-7, 4M-8-9, 4M-10-11, 4M-12-13, 4M-14-15, 4M-16-17, 4M-18-19, 4M-20-22

ÖPPNA NYCKLAR

Dubbel, öppen ringnyckel, förkromad, metrisk



1949M

8x 9 mm	140 mm	1	1949M-8-9
10x11 mm	150 mm	1	1949M-10-11
10x12 mm	150 mm	1	1949M-10-12
12x13 mm	170 mm	1	1949M-12-13
12x14 mm	170 mm	1	1949M-12-14
14x15 mm	170 mm	1	1949M-14-15
14x17 mm	200 mm	1	1949M-14-17
17x19 mm	210 mm	1	1949M-17-19
19x22 mm	220 mm	1	1949M-19-22
22x24 mm	235 mm	1	1949M-22-24
24x27 mm	255 mm	1	1949M-24-27
30x32 mm	280 mm	1	1949M-30-32

Dubbel, öppen ringnyckel, förkromad, tum-dimensioner



1949Z

3/8x7/16 in	150 mm	1	1949Z-3/8-7/16
1/2x9/16 in	170 mm	1	1949Z-1/2-9/16
5/8x3/4 in	210 mm	1	1949Z-5/8-3/4

3/4x7/8 in	220 mm	1	1949Z-3/4-7/8
1x1 1/8 in	255 mm	1	1949Z-1-1.1/8

Tuppfotsnyckel, öppen ringnyckel med 1/4" fyrkantsfäste



679-

7 mm	1/4 in	1	679-7
8 mm	1/4 in	1	679-8
9 mm	1/4 in	1	679-9
10 mm	1/4 in	1	679-10
11 mm	1/4 in	1	679-11
12 mm	1/4 in	1	679-12
13 mm	1/4 in	1	679-13
14 mm	1/4 in	1	679-14
3/8 in	1/4 in	1	679-3/8
7/16 in	1/4 in	1	679-7/16
1/2 in	1/4 in	1	679-1/2
9/16 in	1/4 in	1	679-9/16

Tuppfotsnyckel, öppen ringnyckel med 3/8" invändigt fyrkantsfäste



749-

15 mm	3/8 in	1	749-15
16 mm	3/8 in	1	749-16
17 mm	3/8 in	1	749-17
18 mm	3/8 in	1	749-18
19 mm	3/8 in	1	749-19
20 mm	3/8 in	1	749-20
21 mm	3/8 in	1	749-21
22 mm	3/8 in	1	749-22
23 mm	3/8 in	1	749-23
24 mm	3/8 in	1	749-24
25 mm	3/8 in	1	749-25
26 mm	3/8 in	1	749-26
27 mm	3/8 in	1	749-27
3/8 in	3/8 in	1	749-3/8
7/16 in	3/8 in	1	749-7/16
1/2 in	3/8 in	1	749-1/2
9/16 in	3/8 in	1	749-9/16
5/8 in	3/8 in	1	749-5/8
11/16 in	3/8 in	1	749-11/16
3/4 in	3/8 in	1	749-3/4
13/16 in	3/8 in	1	749-13/16

7/8 in	3/8 in	1	749-7/8
15/16 in	3/8 in	1	749-15/16
1 in	3/8 in	1	749-1
1.1/16 in	3/8 in	1	749-1.1/16
1.1/8 in	3/8 in	1	749-1.1/8
1.3/16 in	3/8 in	1	749-1.3/16
1.1/4 in	3/8 in	1	749-1.1/4
1.5/16 in	3/8 in	1	749-1.5/16
1.3/8 in	3/8 in	1	749-1.3/8
1.7/16 in	3/8 in	1	749-1.7/16
1.1/2 in	3/8 in	1	749-1.1/2
1.9/16 in	3/8 in	1	749-1.9/16
1.5/8 in	3/8 in	1	749-1.5/8
1.11/16 in	3/8 in	1	749-1.11/16
1.3/4 in	3/8 in	1	749-1.3/4
1.13/16 in	3/8 in	1	749-1.13/16
1.7/8 in	3/8 in	1	749-1.7/8
1.15/16 in	3/8 in	1	749-1.15/16
2 in	3/8 in	1	749-2
2.1/8 in	3/8 in	1	749-2.1/8
2.3/16 in	3/8 in	1	749-2.3/16
2.1/4 in	3/8 in	1	749-2.1/4
2.3/8 in	3/8 in	1	749-2.3/8
2.5/8 in	3/8 in	1	749-2.5/8
2.3/4 in	3/8 in	1	749-2.3/4
3.1/8 in	3/8 in	1	749-3.1/8

Tuppfotsnyckel, öppen ringnyckel med 1/2" invändigt fyrkantsfäste



789-

28 mm	1/2 in	1	789-28
30 mm	1/2 in	1	789-30
32 mm	1/2 in	1	789-32
34 mm	1/2 in	1	789-34
36 mm	1/2 in	1	789-36
38 mm	1/2 in	1	789-38
40 mm	1/2 in	1	789-40
41 mm	1/2 in	1	789-41
42 mm	1/2 in	1	789-42
46 mm	1/2 in	1	789-46
50 mm	1/2 in	1	789-50
1.1/8 in	1/2 in	1	789-1.1/8
1.1/4 in	1/2 in	1	789-1.1/4
1.5/16 in	1/2 in	1	789-1.5/16
1.3/8 in	1/2 in	1	789-1.3/8
1.7/16 in	1/2 in	1	789-1.7/16
1.1/2 in	1/2 in	1	789-1.1/2
1.9/16 in	1/2 in	1	789-1.9/16
1.5/8 in	1/2 in	1	789-1.5/8
1.3/4 in	1/2 in	1	789-1.3/4
1.13/16 in	1/2 in	1	789-1.13/16
2 in	1/2 in	1	789-2
2.1/4 in	1/2 in	1	789-2.1/4
2.5/16 in	1/2 in	1	789-2.5/16
2.3/8 in	1/2 in	1	789-2.3/8

Ställbar tuppffotsnyckel med 3/8" fyrkantsfäste



1950MZ

0-29/0-1.1/8 in	1	1950MZ-3/8

SLAGNYCKLAR

Slagringnyckel, metrisk



7444SG-M

24 mm	1	7444SG-M-24
27 mm	1	7444SG-M-27
30 mm	1	7444SG-M-30
32 mm	1	7444SG-M-32
34 mm	1	7444SG-M-34
36 mm	1	7444SG-M-36
38 mm	1	7444SG-M-38
41 mm	1	7444SG-M-41
42 mm	1	7444SG-M-42
46 mm	1	7444SG-M-46
50 mm	1	7444SG-M-50
55 mm	1	7444SG-M-55
60 mm	1	7444SG-M-60
65 mm	1	7444SG-M-65
70 mm	1	7444SG-M-70
75 mm	1	7444SG-M-75
80 mm	1	7444SG-M-80
85 mm	1	7444SG-M-85
90 mm	1	7444SG-M-90
95 mm	1	7444SG-M-95
100 mm	1	7444SG-M-100
105 mm	1	7444SG-M-105
110 mm	1	7444SG-M-110
115 mm	1	7444SG-M-115



120 mm	1	7444SG-M-120
125 mm	1	7444SG-M-125
130 mm	1	7444SG-M-130
135 mm	1	7444SG-M-135
140 mm	1	7444SG-M-140
145 mm	1	7444SG-M-145
150 mm	1	7444SG-M-150
155 mm	1	7444SG-M-155
160 mm	1	7444SG-M-160
165 mm	1	7444SG-M-165
170 mm	1	7444SG-M-170
175 mm	1	7444SG-M-175

Slagringnycklar i tum-dimensioner



7444SG-Z

1 1/16 in	1	7444SG-Z-1.1/16
1 1/8 in	1	7444SG-Z-1.1/8
1 3/16 in	1	7444SG-Z-1.3/16
1 1/4 in	1	7444SG-Z-1.1/4
1 5/16 in	1	7444SG-Z-1.5/16
1 3/8 in	1	7444SG-Z-1.3/8
1 7/16 in	1	7444SG-Z-1.7/16
1 1/2 in	1	7444SG-Z-1.1/2
1 5/8 in	1	7444SG-Z-1.5/8
1 11/16 in	1	7444SG-Z-1.11/16
1 3/4 in	1	7444SG-Z-1.3/4
1 13/16 in	1	7444SG-Z-1.13/16
1 7/8 in	1	7444SG-Z-1.7/8
2 in	1	7444SG-Z-2
2 1/16 in	1	7444SG-Z-2.1/16
2 1/8 in	1	7444SG-Z-2.1/8
2 3/16 in	1	7444SG-Z-2.3/16
2 1/4 in	1	7444SG-Z-2.1/4
2 3/8 in	1	7444SG-Z-2.3/8
2 9/16 in	1	7444SG-Z-2.9/16
2 5/8 in	1	7444SG-Z-2.5/8
2 3/4 in	1	7444SG-Z-2.3/4
3 in	1	7444SG-Z-3
3 1/8 in	1	7444SG-Z-3.1/8
3 3/8 in	1	7444SG-Z-3.3/8
3 1/2 in	1	7444SG-Z-3.1/2
3 3/4 in	1	7444SG-Z-3.3/4
3 7/8 in	1	7444SG-Z-3.7/8
4 in	1	7444SG-Z-4
4 1/8 in	1	7444SG-Z-4.1/8
4 1/2 in	1	7444SG-Z-4.1/2

Metrisk u-slagnyckel



133SGM

27 mm	1	133SGM-27
30 mm	1	133SGM-30
32 mm	1	133SGM-32
36 mm	1	133SGM-36
41 mm	1	133SGM-41
46 mm	1	133SGM-46
50 mm	1	133SGM-50
55 mm	1	133SGM-55
60 mm	1	133SGM-60
65 mm	1	133SGM-65
70 mm	1	133SGM-70
75 mm	1	133SGM-75
80 mm	1	133SGM-80
85 mm	1	133SGM-85
90 mm	1	133SGM-90
95 mm	1	133SGM-95
100 mm	1	133SGM-100
105 mm	1	133SGM-105
110 mm	1	133SGM-110
115 mm	1	133SGM-115
120 mm	1	133SGM-120

Bockade slagringnycklar, metrisk



315M

27 mm	1	315M-27
30 mm	1	315M-30
32 mm	1	315M-32
36 mm	1	315M-36
41 mm	1	315M-41
46 mm	1	315M-46
50 mm	1	315M-50
55 mm	1	315M-55
60 mm	1	315M-60
65 mm	1	315M-65
70 mm	1	315M-70
75 mm	1	315M-75
80 mm	1	315M-80



Bockade slagringnycklar, tum-dimensioner



315Z

Dimension	Antal	Modell
1.1/16 in	1	315Z-1.1/16
1.1/8 in	1	315Z-1.1/8
1.3/16 in	1	315Z-1.3/16
1.1/4 in	1	315Z-1.1/4
1.5/16 in	1	315Z-1.5/16
1.3/8 in	1	315Z-1.3/8
1.7/16 in	1	315Z-1.7/16
1.1/2 in	1	315Z-1.1/2
1.5/8 in	1	315Z-1.5/8
1.11/16 in	1	315Z-1.11/16
1.3/4 in	1	315Z-1.3/4
1.13/16 in	1	315Z-1.13/16
1.7/8 in	1	315Z-1.7/8
1.15/16 in	1	315Z-1.15/16
2 mm	1	315Z-2
2.1/16 in	1	315Z-2.1/16
2.1/8 in	1	315Z-2.1/8
2.3/16 in	1	315Z-2.3/16
2.1/4 in	1	315Z-2.1/4
2.5/16 in	1	315Z-2.5/16
2.3/8 in	1	315Z-2.3/8
2.1/2 in	1	315Z-2.1/2
2.9/16 in	1	315Z-2.9/16
2.5/8 in	1	315Z-2.5/8
2.3/4 in	1	315Z-2.3/4
2.7/8 in	1	315Z-2.7/8
2.15/16 in	1	315Z-2.15/16
3 mm	1	315Z-3
3.1/8 in	1	315Z-3.1/8

Extra kraftiga metrisk bockade ringnycklar



310M

Dimension	Antal	Modell
24 mm	1	310M-24
27 mm	1	310M-27
30 mm	1	310M-30
32 mm	1	310M-32
36 mm	1	310M-36
38 mm	1	310M-38
41 mm	1	310M-41
46 mm	1	310M-46

Dimension	Antal	Modell
50 mm	1	310M-50
55 mm	1	310M-55
60 mm	1	310M-60
65 mm	1	310M-65
70 mm	1	310M-70
75 mm	1	310M-75
80 mm	1	310M-80
85 mm	1	310M-85
90 mm	1	310M-90
95 mm	1	310M-95

Stålrörshandtag för 310M ringnyckel



R310

Dimension	Antal	Modell
24-30 mm	1	R310-0
32-41 mm	1	R310-1
46-55 mm	1	R310-2
60-95 mm	1	R310-3

HYLSNYCKLAR

Metrisk, bockad, dubbelsidig hylsnyckel med 12 x 6-kants Dynamic-Drive™-profil



28M

Dimension	Antal	Modell
6 mm	5	28M-6
7 mm	5	28M-7
8 mm	5	28M-8
9 mm	5	28M-9
10 mm	5	28M-10
11 mm	5	28M-11
12 mm	5	28M-12
13 mm	5	28M-13
14 mm	5	28M-14
15 mm	5	28M-15
16 mm	5	28M-16
17 mm	5	28M-17
18 mm	3	28M-18
19 mm	3	28M-19
20 mm	3	28M-20
21 mm	3	28M-21
22 mm	3	28M-22
23 mm	3	28M-23
24 mm	3	28M-24
25 mm	3	28M-25

Dimension	Antal	Modell
26 mm	3	28M-26
27 mm	3	28M-27
28 mm	1	28M-28
29 mm	1	28M-29
30 mm	1	28M-30
32 mm	1	28M-32
6 mm	10	SB28M-6
7 mm	10	SB28M-7
8 mm	10	SB28M-8
9 mm	10	SB28M-9
10 mm	10	SB28M-10
11 mm	10	SB28M-11
12 mm	10	SB28M-12
13 mm	10	SB28M-13
14 mm	10	SB28M-14
15 mm	10	SB28M-15
16 mm	5	SB28M-16
17 mm	5	SB28M-17
18 mm	5	SB28M-18
19 mm	5	SB28M-19
20 mm	4	SB28M-20
21 mm	4	SB28M-21
22 mm	4	SB28M-22
23 mm	4	SB28M-23
24 mm	4	SB28M-24

Metrisk, bockad, dubbelsidig hylsnyckel med 6-kants Dynamic-Drive™-profil



29M

Dimension	Antal	Modell
6 mm	5	29M-6
7 mm	5	29M-7
8 mm	5	29M-8
9 mm	5	29M-9
10 mm	5	29M-10
11 mm	5	29M-11
12 mm	5	29M-12
13 mm	5	29M-13
14 mm	5	29M-14
15 mm	5	29M-15
16 mm	5	29M-16
17 mm	5	29M-17
18 mm	3	29M-18
19 mm	3	29M-19
20 mm	3	29M-20
21 mm	3	29M-21
22 mm	3	29M-22
23 mm	3	29M-23
24 mm	3	29M-24
25 mm	3	29M-25
26 mm	3	29M-26
27 mm	3	29M-27
28 mm	1	29M-28
29 mm	1	29M-29
30 mm	1	29M-30
32 mm	1	29M-32

Sats med metriska, bockade, dubbelsidiga hylsnycklar med 12 x 6-kants Dynamic-Drive™-profil, 8 delar



28M/



8

1 28M/8

28M-8, 28M-10, 28M-11, 28M-13, 28M-16, 28M-17, 28M-18, 28M-19



Sats med metriska, bockade, dubbelsidiga rörhylsor med 12 x 6-kants Dynamic-Drive™-profil, 11 delar



28M/11



11

1 28M/11

28M-8, 28M-9, 28M-10, 28M-11, 28M-13, 28M-12, 28M-14, 28M-15, 28M-17, 28M-19, 28M-22



Sats med metriska, bockade, dubbelsidiga rörhylsor med 12 x 6-kants Dynamic-Drive™-profil, 12 delar



28M/12



12

1 28M/12

28M-8, 28M-9, 28M-10, 28M-11, 28M-12, 28M-13, 28M-14, 28M-15, 28M-16, 28M-17, 28M-18, 28M-19



Sats med metriska, bockade, dubbelsidiga rörhylsor med 12 x 6-kants Dynamic-Drive™-profil, 15 delar



28M/15



15

1 28M/15

28M-8, 28M-9, 28M-10, 28M-11, 28M-12, 28M-13, 28M-14, 28M-15, 28M-16, 28M-17, 28M-18, 28M-19, 28M-21, 28M-22, 28M-24



Sats med metriska, bockade, dubbelsidiga hylsnycklar med 6-kants Dynamic-Drive™-profil, 8 delar



29M/

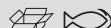

8

1 29M/8

29M-8, 29M-10, 29M-12, 29M-13, 29M-14, 29M-17, 29M-19, 29M-22



Sats med metriska, bockade, dubbelsidiga hylsnycklar med 6-kants Dynamic-Drive™-profil, 10 delar



29M/10



10

1 29M/10

29M-8, 29M-10, 29M-11, 29M-12, 29M-13, 29M-14, 29M-16, 29M-17, 29M-18, 29M-19



Sats med metriska, bockade, dubbelsidiga hylsnycklar med 6-kants Dynamic-Drive™-profil, 14 delar



29M/14



14

1 29M/14

29M-11, 29M-12, 29M-13, 29M-14, 29M-8, 29M-9, 29M-10, 29M-16, 29M-17, 29M-21, 29M-22, 29M-19, 29M-24, 29M-23



Sats med metriska dubbelsidiga raka rörhylsor, förkromade, 7 delar



1936M



6x7 mm	50	1936M-6-7
8x9 mm	5	1936M-8-9
8x10 mm	30	1936M-8-10
10x11 mm	25	1936M-10-11
10x13 mm	25	1936M-10-13
12x13 mm	25	1936M-12-13
13x17 mm	20	1936M-13-17
14x15 mm	20	1936M-14-15
14x17 mm	15	1936M-14-17
16x17 mm	15	1936M-16-17
17x19 mm	10	1936M-17-19
18x19 mm	10	1936M-18-19
19x22 mm	8	1936M-19-22
20x22 mm	8	1936M-20-22
21x23 mm	8	1936M-21-23
22x24 mm	5	1936M-22-24
24x26 mm	5	1936M-24-26
24x27 mm	5	1936M-24-27
25x28 mm	5	1936M-25-28
30x32 mm	1	1936M-30-32
30x34 mm	4	1936M-30-34
36x41 mm	4	1936M-36-41
46x50 mm	2	1936M-46-50



Metrisk dubbla raka rörhylsor, förkromade



27M



6x7 mm	10	27M-6-7
8x9 mm	10	27M-8-9
10x11 mm	10	27M-10-11
12x13 mm	10	27M-12-13
13x17* mm	10	27M-13-17
14x15 mm	10	27M-14-15
16x17* mm	10	27M-16-17
16x18* mm	10	27M-16-18
18x19* mm	10	27M-18-19
20x22* mm	10	27M-20-22
21x23* mm	5	27M-21-23
21x24* mm	5	27M-21-24
24x26* mm	5	27M-24-26
24x27* mm	5	27M-24-27
25x28* mm	5	27M-25-28
27x29* mm	5	27M-27-29
30x32* mm	5	27M-30-32
6x7 mm	10	SB27M-6-7
8x9 mm	10	SB27M-8-9
10x11 mm	10	SB27M-10-11
12x13 mm	10	SB27M-12-13
14x15 mm	10	SB27M-14-15
16x17* mm	10	SB27M-16-17
18x19* mm	10	SB27M-18-19
20x22* mm	10	SB27M-20-22
21x23* mm	5	SB27M-21-23
24x26* mm	5	SB27M-24-26

Sizes marked with * in the table have a hole along the shank

Sats med metrisk dubbelsidiga rörhylsor



1936M/



7 1 1936M/7

1936M-8-9, 1936M-10-11, 1936M-12-13,
1936M-14-15, 1936M-16-17, 1936M-18-19,
1936M-20-22

26S-610

Sats med metrisk dubbelsidiga raka rörhylsor, förkromade, 12 delar



1936M/12



12 1 1936M/12

1936M-6-7, 1936M-8-9, 1936M-10-11,
1936M-12-13, 1936M-14-15, 1936M-16-17,
1936M-18-19, 1936M-20-22, 1936M-21-23,
1936M-24-27, 1936M-25-28, 1936M-30-32

26S-610, 26S-1216, 26S-16

Sats med metrisk dubbelsidiga rörhylsor, 8 delar



27M/T



8 1 27M/8T

27M-6-7, 27M-8-9, 27M-10-11, 27M-12-13,
27M-14-15, 27M-16-17, 27M-18-19,
27M-20-22

Sats med metrisk dubbelsidiga rörhylsor, 12 delar



27M/12T



12 1 27M/12T

27M-6-7, 27M-8-9, 27M-10-11, 27M-12-13,
27M-14-15, 27M-16-17, 27M-18-19,
27M-20-22, 27M-21-23, 27M-24-26,
27M-25-28, 27M-30-32

Sats med metrisk dubbelsidiga rörhylsor, 6 delar



27M/



6 1 27M/6

27M-6-7, 27M-8-9, 27M-10-11, 27M-12-13,
27M-14-15, 27M-16-17

Sats med metrisk dubbelsidiga rörhylsor, 8 delar



27M/8



8 1 27M/8

27M-6-7, 27M-8-9, 27M-10-11, 27M-12-13,
27M-14-15, 27M-16-17, 27M-18-19,
27M-20-22

Sats med metrisk dubbelsidiga rörhylsor, 10 delar



27M/10



10 1 27M/10

27M-6-7, 27M-8-9, 27M-10-11, 27M-12-13,
27M-14-15, 27M-16-17, 27M-18-19,
27M-20-22, 27M-21-23, 27M-24-26

Sats med metriska dubbelsidiga rörhylsor, 12 delar



27M/12



12

1 27M/12

27M-6-7, 27M-8-9, 27M-10-11, 27M-12-13, 27M-14-15, 27M-16-17, 27M-18-19, 27M-20-22, 27M-21-23, 27M-24-26, 27M-25-28, 27M-30-32



Vridpinne med steg med förkromad yta



26S



6 8 10 mm
12 14 mm
16 mm

10 26S-610
8 26S-1216
5 26S-16

Metriska, dubbelsidiga ledhylsnycklar med tolvkantprofil



4040M



6x7 mm
8x9 mm
10x11 mm
10x13 mm

1 4040M-6-7
1 4040M-8-9
1 4040M-10-11
1 4040M-10-13



12x13 mm
13x17 mm
14x15 mm
16x17 mm
16x18 mm
17x19 mm
18x19 mm
20x22 mm
21x23 mm
24x27 mm

1 4040M-12-13
1 4040M-13-17
1 4040M-14-15
1 4040M-16-17
1 4040M-16-18
1 4040M-17-19
1 4040M-18-19
1 4040M-20-22
1 4040M-21-23
1 4040M-24-27

Dubbelsidiga ledhylsnycklar med tolvkantprofil, tum-dimensioner



4040Z



3/8x7/16 in
1/2x9/16 in
5/8x11/16 in
5/8x3/4 in
13/16x7/8 in

1 4040Z-3/8-7/16
1 4040Z-1/2-9/16
1 4040Z-5/8-11/16
1 4040Z-5/8-3/4
1 4040Z-13/16-7/8

Sats med metriska, dubbelsidiga ledhylsnycklar med tolvkantprofil



4040M/S6



6 1 4040M/S6

4040M-8-9, 4040M-10-11, 4040M-12-13, 4040M-14-15, 4040M-16-17, 4040M-18-19



Sats med metriska, dubbelsidiga ledhylsnycklar med tolvkantprofil, i plastetui



4040M/6T



6

1 4040M/6T

4040M-8-9, 4040M-10-11, 4040M-12-13, 4040M-14-15, 4040M-16-17, 4040M-18-19



SATS MED AVSTÄNGARE

5 i 1 universalnyckel för avstängare



MK5



97x25 mm

1 MK5

Fyrkant: 5,6,7-8mm Trekant: 9 mm Tvåvägsnyckel: 3-5 mm

9 i 1 universalnyckel för avstängare



MK9



95x95 mm

1 MK9

Fyrkant: 5,6,7-8,9-10 mm Trekant: 7,8-9,10-11 mm Tvåvägsnyckel: 3-5 mm Halvmåne: 6 mm



HAKNYCKLAR

Haknyckel, förkromad



4106



19-50 mm	25	4106-19-50
32-75 mm	25	4106-32-75
50-120 mm	20	4106-50-120
115-165 mm	25	4106-115-165
150-230 mm	8	4106-150-230

Reservstift till haknyckel



40B-SP



40B-19-50	1	40B-19-50-SP
40B-32-75	1	40B-32-75-SP
40B-50-120	1	40B-50-120-SP
40B-115-165	1	40B-115-165-SP

Haknyckel, förkromad



40B



19-50 mm	25	40B-19-50
32-75 mm	25	40B-32-75
50-120 mm	20	40B-50-120
115-165 mm	25	40B-115-165
150-230 mm	8	40B-150-230

Justerbar stiftnyckel med förkromad yta



4307/4310



10-50 mm	1	4307
22-100 mm	1	4310



Hylsor och spärrhandtag



HYLSNYCKELSATSER

1/4" och 1/2" hylsnyckelsats och med standardhylsor och långa hylsor med fyrkantfäste och sexkantprofil samt U-ringnyckelsats



S910



110 x 320 x 375 mm



2 S910

Hylsnyckelsats med U-ringnycklar, insexnycklar och bits – 95 delar



S95



110 x 320 x 375 mm



2 S95

1/4" och 1/2" hylsnyckelsats med fyrkantfäste



S87+7



110 x 430 x 375 mm



2 S87+7

1 pce removable three section plastic box with lid

1/4" och 1/2" hylsnyckelsats med fyrkantfäste samt U-ringnycklar och insexnycklar



S106



110 x 430 x 375 mm



2 S106

1/4" och 1/2" hylsnyckelsats med fyrkantfäste samt U-ringnyckelsats



S103



110 x 375 x 430 mm



2 S103

1/4" och 1/2" hylsnyckelsats med fyrkantfäste samt U-ringnycklar och bitshylsor



S108



110 x 430 x 375 mm



2 S108

1/4" och 1/2" hylsnyckelsats med fyrkantfäste och sexkantprofil samt U-ringnycklar, bitsats, tänger



S81MIX



110 x 430 x 375 mm



2 S81MIX

1/4" och 1/2" hylsnyckelsats med fyrkantfäste och sexkantprofil samt sats med U-ringnycklar



S410



110 x 320 x 375 mm



2 S410

1/4" och 1/2" hylsnyckelsats med fyrkantfäste



S800



110 x 375 x 430 mm



2 S800

Hylsnyckelsats 1/4", 1/2" med metriska hylsor och smalt spärrhandtag-79 delar



SL79



100 x 215 x 370 mm

4 SL79

Hylsnyckelsats 1/4", 3/8" med metriska hylsor och smalt spärrhandtag-91 delar



SL91



100 x 215 x 370 mm

4 SL91

Hylsnyckelsats 1/4", 3/8", 1/2" med metriska sexkantshylsor och u-ringnycklar-137 delar



S137



105 x 370 x 430 mm

2 S137

Hylsnyckelsats 1/4", 1/2" med metriska hylsor och smalt spärrhandtag-79 delar



SW79



100 x 215 x 370 mm

4 SW79

Hylsnyckelsats 1/4" och 3/8", metriska dimensioner och spärrhandtag med ledat huvud, 91 delar



SW91



100 x 215 x 370 mm

4 SW91

Hylsnyckelsats 1/4", 1/2" långa och korta hylsor i tum-dimensioner. Med u-ringnyckelsats. 92 delar



S910AF



110 x 320 x 370 mm

2 S910AF

1/4" och 1/2" hylsnyckelsats med fyrkantfäste, tolvkantprofil och spärrhandtag med smalt huvud



S560



100 x 215 x 375 mm

4 S560

1/4", 3/8" och 1/2" hylsnyckelsats med fyrkantfäste samt U-ringnycklar och bits



S138



110 x 375 x 430 mm

2 S138

SBS81

SBS61



1/4" sats med långa hylsor med fyrkantfäste och tolvkantprofil



S0810L



35 x 85 x 160 mm

20 S0810L



1/4" hylsnyckelsats med fyrkantfäste, sexkantsprofil med bits och bitshållare



SL25



35 x 85 x 160 mm
55 x 80 x 165 mm



24 SL25
5 SBSL25

1/4" hylsnyckelsats med fyrkantfäste och sexkantsprofil samt spärrhandtag



S160



70 x 160 x 280 mm



6 S160

Hylsnyckelsats 1/4" med metrisk hylsor och smalt spärrhandtag-65 delar



SL65



70 x 160 x 280 mm



6 SL65

1/4" hylsnyckelsats med sexkantshylsor med fyrkantfäste, spärrhandtag, bits, förlängare och universalknut



SL24



35 x 85 x 160 mm



1 SL24

1/4" hylsnyckelsats med fyrkantfäste och sexkantsprofil samt spärrhandtag/bitshylsor



S290



70 x 160 x 280 mm



6 S290

1/4" hylsnyckelsats med metrisk hylsor och spärrhandtag med vridbart huvud



SW65



70 x 160 x 280 mm



6 SW65

1/4" hylsnyckelsats med fyrkantfäste, sexkantsprofil med hylsor och bits



SL25L



46 x 130 x 195 mm



10 SL25L

1/4" hylsnyckelsats med fyrkantfäste och sexkantsprofil samt bitshylsor



S460



100 x 215 x 375 mm



6 S460

1/4" hylsnyckelsats med fyrkantfäste och sexkantsprofil med skruvmejselbits/bitshållare, tum-skala



SL25AF



35 x 85 x 165 mm



1 SL25AF

1/4" hylsnyckelsats med fyrkantfäste och sexkantprofil samt spärrhandtag



S160AF



70 x 160 x 280 mm

6 S160AF

1/4" hylsnyckelsats med metrisk sexkantshylsor, spärrhandtag med päronformat huvud och förlängare



6712R



31 x 110 x 178 mm

1 6712R

6700SM-4, 6700SM-5, 6700SM-5.5, 6700SM-6, 6700SM-7, 6700SM-8, 6700SM-10, 6700SM-11, 6700SM-13

6950

6960, 6962

1/4" hylsnyckelsats med sexkantshylsor, spärrhandtag med runt huvud samt förlängare



6712RN



31 x 108 x 178 mm

1 6712RN

6700SM-4, 6700SM-5, 6700SM-5.5, 6700SM-6, 6700SM-7, 6700SM-8, 6700SM-10, 6700SM-11, 6700SM-13

6960, 6962

6950RN

1/4" hylsnyckelsats med tolvkantshylsor med fyrkantfäste, spärrhandtag med päronformat huvud, t-stängshandtag, vridhandtag, universalknut och förlängare



A6716DM



35 x 111 x 223 mm

1 A6716DM

A6700DM-5.5, A6700DM-6, A6700DM-7, A6700DM-8, A6700DM-9, A6700DM-10, A6700DM-11, A6700DM-12, A6700DM-13, A6700DM-14

6956

6962

6966

6954

6950

1/4" hylsnyckelsats med metrisk sexkantshylsor, spärrhandtag med runt huvud, förlängare, t-stängshandtag, vridhandtag och universalknut



6715MGS



34 x 113 x 223 mm

1 6715MGS

SB6700SM-4, 6700SM-4.5, 6700SM-5, 6700SM-5.5, 6700SM-6, 6700SM-7, 6700SM-8, 6700SM-9, 6700SM-10, 6700SM-11, 6700SM-13

6954

6950RN

6956

6966

6962

1/4" hylsnyckelsats med fyrkantfäste, sexkantprofil och spärrhandtag med runt huvud och T-handtag



6719MHR



50 x 110 x 220 mm

1 6719MHR

6700SM-4, 6700SM-4.5, 6700SM-5.5, 6700SM-5, 6700SM-6, 6700SM-7, 6700SM-8, 6700SM-9, 6700SM-10, 6700SM-11, 6700SM-12, 6700SM-13, 6700SM-14

6950RN

6960, 6962

6954

6956

6966

1/4" hylsnyckelsats med metrisk sexkantshylsor, spärrhandtag med runt huvud, bitsadapter, bits, förlängare, vridhandtag och universalknut



6729MHR



50 x 110 x 220 mm

1 6729MHR

6700SM-4, 6700SM-5, 6700SM-6, 6700SM-7, 6700SM-8, 6700SM-9, 6700SM-10, 6700SM-11, 6700SM-13, 6700SM-14

6950RN

6960, 6962

6966

6956

6973A

59S/PH1, 59S/PH2, 59S/PH3

59S/PZ1, 59S/PZ2, 59S/PZ3

59S/0.6-4.5, 59S/0.8-5.5, 59S/1.2-6.5

59S/H3, 59S/H4, 59S/H5, 59S/H6



1/4" hylsnyckelsats med metrisk sexkantshylsor, spärrhandtag med päronformat huvud, bitsadapter, bits, förlängare, vridhandtag och universalknut



6729MHP



50 x 110 x 220 mm

1 6729MHP

6700SM-4, 6700SM-5, 6700SM-6, 6700SM-7, 6700SM-8, 6700SM-9, 6700SM-10, 6700SM-11, 6700SM-13, 6700SM-14



6950



6960, 6962



6966



6956



6973A



59S/0.6-4.5, 59S/0.8-5.5, 59S/1.2-6.5



59S/PZ1, 59S/PZ2, 59S/PZ3



59S/PH1, 59S/PH2, 59S/PH3



59S/H3, 59S/H4, 59S/H5, 59S/H6



1/4" hylsnyckelsats med metrisk tolvkantshylsor, spärrhandtag med päronformat huvud, förlängare, t-stångshandtag, vridhandtag och universalknut



6717MBP



50 x 110 x 220 mm

1 6717MBP

A6700DM-5, A6700DM-5.5, A6700DM-6, A6700DM-7, A6700DM-8, A6700DM-9, A6700DM-10, A6700DM-11, A6700DM-12, A6700DM-13, A6700DM-14



6950



6960, 6962



6954



6966



6956



1/4" metrisk hylsnyckelsats med fyrkantfäste, tolvkantprofil och spärrhandtag med päronformat huvud, bitsadapter, bits, förlängare, t-stångshandtag, vridhandtag och universalknut



6730MBP



50 x 110 x 220 mm

1 6730MBP

A6700DM-5, A6700DM-5.5, A6700DM-6, A6700DM-7, A6700DM-8, A6700DM-9, A6700DM-10, A6700DM-11, A6700DM-12, A6700DM-13, A6700DM-14



6950



6960, 6962



6954



6966



6956



6973A



59S/0.6-4.5, 59S/1.2-6.5, 59S/0.8-5.5



59S/PH1, 59S/PH2, 59S/PH3



59S/PZ1, 59S/PZ2, 59S/PZ3



59S/H3, 59S/H4, 59S/H5, 59S/H6



1/4" hylsnyckelsats med metrisk sexkantshylsor, spärrhandtag med päronformat huvud, förlängare, t-stångshandtag, vridhandtag och universalknut



6719SM



41 x 113 x 223 mm

1 6719SM

6700SM-4, 6700SM-4.5, 6700SM-5, 6700SM-5.5, 6700SM-6, 6700SM-7, 6700SM-8, 6700SM-9, 6700SM-10, 6700SM-11, 6700SM-12, 6700SM-13



6954



6950



6956



6966



6962



1/4" hylsnyckelsats med metrisk sexkantshylsor, spärrhandtag med runt huvud, ledhandtag, förlängare, universalknut, vridhandtag och t-stångshandtag



6715MG



35 x 111 x 223 mm

1 6715MG

6700SM-4, 6700SM-4.5, 6700SM-5, 6700SM-5.5, 6700SM-6, 6700SM-7, 6700SM-8, 6700SM-9, 6700SM-10, 6700SM-11, 6700SM-12, 6700SM-13, 6700SM-14

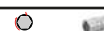

6954



6958



6956



6962, 6960



6966



6950RN



1/4" hylsnyckelsats med metrisk sexkantshylsor, spärrhandtag med päronformat huvud, adapter, ledhandtag, förlängare, t-stångshandtag, vridhandtag och universalknut



6721NM



41 x 113 x 223 mm

1 6721NM

6700SM-4, 6700SM-4.5, 6700SM-5, 6700SM-5.5, 6700SM-6, 6700SM-7, 6700SM-8, 6700SM-9, 6700SM-10, 6700SM-11, 6700SM-12, 6700SM-13, 6700SM-14



6954



6956



6950



6962, 6960



6966



6958



1/4" hylsnyckelsats med metriska sexkantshylsor, spärrhandtag med päronformat huvud, bitsadapter, bits, förlängare, t-stångshandtag, vridhandtag och universalknut



6722M



41 x 113 x 223 mm

1 6722M

55M 0.6x4, 1x6, 1x7

6700SM-4, 6700SM-5, 6700SM-6, 6700SM-7, 6700SM-8, 6700SM-9, 6700SM-10, 6700SM-11, 6700SM-13, 6700SM-14		
6954		
6956		
6950		
6966		
6960, 6962		
6972H		
59S/H3, 59S/H4, 59S/H5, 59S/H6		
59S/PH1, 59S/PH2, 59S/PH3		

1/4" hylsnyckelsats med fyrkantfäste, sexkantprofil och spärrhandtag med päronformat huvud och bitshylsa



6715PZ



41 x 113 x 223 mm

1 6715PZ

6700SM-4, 6700SM-4.5, 6700SM-5, 6700SM-5.5, 6700SM-6, 6700SM-7, 6700SM-8, 6700SM-9, 6700SM-10, 6700SM-11, 6700SM-12, 6700SM-13		
6956		
6950		
6954		
6962, 6960		
6966		
6709F-4.5, 6709F-5.5, 6709F-8		
6709M-3, 6709M-4, 6709M-5, 6709M-6, 6709M-8		
6709PZ-1, 6709PZ-3, 6709PZ-2		

1/4" hylsnyckelsats med fyrkantfäste, sexkantprofil och spärrhandtag med päronformat huvud



6720NM



43 x 114 x 351 mm

1 6720NM

6700SM-4, 6700SM-4.5, 6700SM-5, 6700SM-5.5, 6700SM-6, 6700SM-7, 6700SM-8, 6700SM-9, 6700SM-10, 6700SM-11, 6700SM-12, 6700SM-13, 6700SM-14		
1931M-4, 1931M-4.5, 1931M-9, 1931M-10, 1931M-11, 1931M-14, 1931M-13, 1931M-12, 1931M-7, 1931M-8, 1931M-6, 1931M-5.5, 1931M-5		
6954		
6950		
6956		
221 D		
73721-3-80		
6966		
6962		

1/4" hylsnyckelsats med sexkantshylsor, spärrhandtag med runt huvud, bitsadapter, bits, förlängare, t-stångshandtag, vridhandtag och universalknut



6715GE



31 x 113 x 223 mm

1 6715GE

50MH 0.6x4, 1x6, 1x7

6700SM-4, 6700SM-5, 6700SM-6, 6700SM-7, 6700SM-8, 6700SM-9, 6700SM-10, 6700SM-11, 6700SM-13, 6700SM-14		
6956		
6950RN		
6954		
6966		
6960, 6962		
6972H		
59S/H3, 59S/H4, 59S/H5, 59S/H6		
59S/PH1, 59S/PH2, 59S/PH3		

1/4" hylsnyckelsats med metriska sexkantshylsor, spärrhandtag med päronformat huvud, vridhandtag, bitshylsor, förlängare, t-stångshandtag och universalknut



6715GJ



50 x 113 x 223 mm

1 6715GJ

6700SM-4, 6700SM-4.5, 6700SM-5, 6700SM-5.5, 6700SM-6, 6700SM-7, 6700SM-8, 6700SM-9, 6700SM-10, 6700SM-11, 6700SM-12, 6700SM-13		
6956		
6962, 6960		
6709F-4.5, 6709F-5.5, 6709F-8		
6709M-5, 6709M-6, 6709M-8, 6709M-4, 6709M-3		
6954		
6950		
6966		
6709PH-1, 6709PH-2, 6709PH-3		

1/4" hylsnyckelsats med tolvkantshylsor med fyrkantfäste i tum-dimensioner, spärrhandtag med päronformat huvud, universalknut, vridhandtag, t-stångshandtag och förlängare



A6716DZ



41 x 113 x 223 mm

1 A6716DZ

A6700DZ-3/16, A6700DZ-7/32, A6700DZ-1/4, A6700DZ-9/32, A6700DZ-5/16, A6700DZ-11/32, A6700DZ-3/8, A6700DZ-7/16, A6700DZ-1/2, A6700DZ-9/16		
6956		
6962		
6966		
6954		
6950		



1/4" hylsnyckelsats med fyrkantfäste och tolvkantprofil, tum-skala – 18 delar



A6718DZ

41 x 113 x 223 mm	1185 g	1	A6718DZ

Metallåda

6950	
6951	
6956	
6954	
6958	
6960, 6962	
6966	
A6700DZ-3/16, A6700DZ-7/32, A6700DZ-1/4, A6700DZ-9/32, A6700DZ-5/16, A6700DZ-11/32, A6700DZ-3/8, A6700DZ-7/16, A6700DZ-1/2, A6700DZ-9/16	

1/4" hylsnyckelsats med fyrkantfäste, sexkantprofil och spärrhandtag med päronformat huvud och ledhandtag, tum-skala



A6821NZ

50 x 113 x 223 mm	1	A6821NZ

6700SZ-1/4, 6700SZ-11/32, 6700SZ-1/2, 6700SZ-3/16, 6700SZ-5/32, 6700SZ-7/32, 6700SZ-9/32, 6700SZ-5/16, 6700SZ-3/8, 6700SZ-7/16, 6700SZ-9/16	
6954	
6958	
6950	
6956	
6960, 6962	
6966	
6951	

1/4" hylsnyckelsats med sexkantshylsor i tum och mm, spärrhandtag med päronformat huvud, förlängare, t-stångs-handtag, vridhandtag och universalknut.



A6715MZ

40 x 126 x 230 mm	1	A6715MZ

6700SM-4, 6700SM-4.5, 6700SM-5, 6700SM-5.5, 6700SM-6, 6700SM-8, 6700SM-9, 6700SM-10, 6700SM-11, 6700SM-13	
6700SZ-7/32, 6700SZ-3/16, 6700SZ-1/4, 6700SZ-9/32, 6700SZ-5/16, 6700SZ-11/32, 6700SZ-3/8, 6700SZ-7/16, 6700SZ-1/2	
6954	
6950	
6956	
6966	
6962	

1/4" sats med metrisk sexkantshylsor på fästskena samt vridhandtag



A6729SM

25 x 55 x 190 mm	1	A6729SM

6700SM-4, 6700SM-4.5, 6700SM-5, 6700SM-5.5, 6700SM-6, 6700SM-7, 6700SM-8, 6700SM-9, 6700SM-10, 6700SM-11, 6700SM-12, 6700SM-13, 6700SM-14	
6956	

1/4" sats med sexkantshylsor i tum-skala på fästskena samt vridhandtag



A6729SZ

25 x 55 x 190 mm	1	A6729SZ

6700SZ-1/4, 6700SZ-11/32, 6700SZ-1/2, 6700SZ-3/16, 6700SZ-7/32, 6700SZ-3/8, 6700SZ-7/16	
6956	

1/4" hylsnyckelsats med fyrkantfäste och sexkantprofil



A6713MH

13	1	A6713MH

6700SM-4, 6700SM-4.5, 6700SM-5, 6700SM-5.5, 6700SM-6, 6700SM-7, 6700SM-8, 6700SM-9, 6700SM-10, 6700SM-11, 6700SM-12, 6700SM-13, 6700SM-14	
---	--

1/4" sats med långa hylsor med fyrkantfäste och tolvkantprofil på fästskena



A6708DMB

8	1	A6708DMB

A6800DM-6, A6800DM-7, A6800DM-8, A6800DM-9, A6800DM-10, A6800DM-11, A6800DM-12, A6800DM-13	
--	--

1/4" hylsnyckelsats med fyrkantfäste och metrisk tolvkantprofil



6711MB

11 1 6711MB

A6700DM-5, A6700DM-5.5, A6700DM-6, A6700DM-7, A6700DM-8, A6700DM-9, A6700DM-10, A6700DM-11, A6700DM-12, A6700DM-13, A6700DM-14

1/4" sats med hylsnycklar med fyrkantfäste, för Torx®-skruv



6706TE

6 1 6706TE

6700TORX-E4, 6700TORX-E5, 6700TORX-E6, 6700TORX-E7, 6700TORX-E8, 6700TORX-E10

1/4" hylsnyckelsats med fyrkantfäste och sexkantprofil samt spärrhandtag för kylanläggningar



R6725MK

26 x 105 x 175 mm 1 R6725MK

6700SM-7, 6700SM-8, 6700SM-10

6954

R6967

R6810M-3,4, R6810M-4, R6810M-4,5, R6810M-5, R6810M-6, R6810M-7, R6810M-8, R6810M-9, R6810M-10

6966

R6950

6962

R6964A

1/4" hylsnyckelsats med sexkantshylsor med fyrkantfäste i tum-dimensioner, samt tillbehör passande för kylanläggningar



R6725ZK

48 x 115 x 225 mm 1 R6725ZK

6700SZ-1/4, 6700SZ-5/16, 6700SZ-11/32, 6700SZ-3/8, 6700SZ-7/16, 6700SZ-1/2

6954

R6967

R6950

6962

R6810M-6

R6964A

6966

R6810Z-3/16, R6810Z-7/32, R6810Z-1/4, R6810Z-5/16, R6810Z-3/8

R6822Z

3/8" sats med långa hylsor med fyrkantfäste



S1214L

49 x 152 x 280 mm 10 S1214L

1/4" och 3/8" hylsnyckelsats med fyrkantfäste och sexkantprofil samt spärrhandtag



S330

70 x 160 x 280 mm 6 S330

1/4" och 3/8" lång hylsnyckelsats med fyrkantfäste och sexkantprofil samt spärrhandtag



S330L

100 x 215 x 375 mm 4 S330L

3/8" hylsnyckelsats med hylsor med fyrkantfäste och sexkantprofil, metrisk och tum-dimensioner



S380

100 x 215 x 375 mm 4 S380



Hylssats 3/8"-34 delar



SL34



70 x 160 x 280 mm



6 SL34

Hylsnyckelsats med genomgående hylsor, ledat spärrhandtag och förlängare



S140T



65 x 160 x 280 mm



1 S140T

1 pc pass-through extension bar, 75 mm

SBS19-TH10, SBS19-TH11, SBS19-TH12, SBS19-TH13, SBS19-TH14, SBS19-TH15, SBS19-TH16, SBS19-TH17, SBS19-TH18, SBS19-TH19, SBS19-TH21, SBS19-TH22, SBS19-TH24



Ledat spärrhandtag för genomgående hylsor och mellanstycken för sexkants- till fyrkantfäste



S140T-R



121 x 280 x 220 mm



10 S140T-R

1RMA-19-1/2-SQ



Hylsnyckelsats med genomgående hylsor och ledat spärrhandtag



S530T



90 x 205 x 370 mm



4 S530T

1/4" och 3/8" hylsnyckelsats med fyrkantfäste och sexkantsprofil samt spärrhandtag



S330AF



70 x 160 x 280 mm



6 S330AF

3/8" hylsnyckelsats med fyrkantfäste, sexkantsprofil och spärrhandtag med runt huvud, metrisk



7420RE



50 x 115 x 312 mm



1 7420RE

7755-3/8

7400SM-11, 7400SM-10, 7400SM-8, 7400SM-17, 7400SM-18, 7400SM-19, 7400SM-15, 7400SM-14, 7400SM-13, 7400SM-12, 7400SM-16



7761



3/8" hylsnyckelsats med fyrkantfäste, metrisk sexkantsprofil och spärrhandtag med runt huvud och ledhandtag



7440ME



57 x 205 x 278 mm



1 7440ME

7400SM-11, 7400SM-10, 7400SM-15, 7400SM-14, 7400SM-13, 7400SM-12, 7400SM-7, 7400SM-6, 7400SM-9, 7400SM-8, 7400SM-17, 7400SM-19

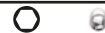

7758

7755-3/8

7761

3/8" hylsnyckelsats med fyrkantfäste, metrisk sexkantsprofil och spärrhandtag med runt huvud och förlängare med kula



7430GE



50 x 115 x 312 mm



1 7430GE

7754

7762, 7761

7400SM-7, 7400SM-6, 7400SM-11, 7400SM-10, 7400SM-15, 7400SM-14, 7400SM-13, 7400SM-12, 7400SM-9, 7400SM-8, 7400SM-17, 7400SM-19



7766

7755-3/8

3/8" hylsnyckelsats med tolvkantshylsor med fyrkantfäste i metrisk dimensioner, spärrhandtag, svänghandtag, t-stångshandtag, universalknut och förlängare



A7435DME



40 x 150 x 500 mm



1 A7435DME

A7400DM-9, A7400DM-10, A7400DM-11, A7400DM-12, A7400DM-13, A7400DM-14, A7400DM-15, A7400DM-16, A7400DM-17, A7400DM-18, A7400DM-19, A7400DM-20, A7400DM-21, A7400DM-22



7755-3/8



7754



7760, 7762, 7761



7758



7752



7766



3/8" hylsnyckelsats med tolvkantshylsor med fyrkantfäste i tum-dimensioner, spärrhandtag, ledhandtag och förlängare



A7440DZE



50 x 115 x 312 mm



1 A7440DZE

A7400DZ-1/4, A7400DZ-5/16, A7400DZ-3/8, A7400DZ-7/16, A7400DZ-1/2, A7400DZ-9/16, A7400DZ-3/4, A7400DZ-13/16, A7400DZ-7/8, A7400DZ-5/8, A7400DZ-11/16

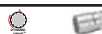

7755-3/8



7758



7761



3/8" hylsnyckelsats med tolvkantshylsor med fyrkantfäste i metrisk dimensioner, spärrhandtag, ledhandtag och förlängare



A7440DME



50 x 115 x 312 mm



1 A7440DME

7755-3/8



7758



7761



A7400DM-9, A7400DM-12, A7400DM-13, A7400DM-14, A7400DM-15, A7400DM-16, A7400DM-17, A7400DM-10, A7400DM-11, A7400DM-22, A7400DM-20, A7400DM-21, A7400DM-18, A7400DM-19



3/8" hylsnyckelsats med fyrkantfäste, tolvkantsprofil och spärrhandtag med runt huvud



7422MBR



60 x 220 x 280 mm



1 7422MBR

A7400DM-6, A7400DM-7, A7400DM-8, A7400DM-9, A7400DM-10, A7400DM-11, A7400DM-12, A7400DM-13, A7400DM-14, A7400DM-15, A7400DM-16, A7400DM-17, A7400DM-18, A7400DM-19, A7400DM-20, A7400DM-21, A7400DM-22



7750RN



7760, 7762



7754



7766



3/8" hylsnyckelsats med fyrkantfäste, metrisk sexkantprofil och spärrhandtag med runt huvud, förlängare, universalknut och T-handtag



7422MHR



50 x 160 x 350 mm



1 7422MHR

7400SM-6, 7400SM-7, 7400SM-8, 7400SM-9, 7400SM-10, 7400SM-11, 7400SM-12, 7400SM-13, 7400SM-14, 7400SM-15, 7400SM-16, 7400SM-17, 7400SM-18, 7400SM-19, 7400SM-20, 7400SM-21, 7400SM-22



7750RN



7760, 7762



7754



7766



3/8" hylsnyckelsats med tolvkantshylsor med fyrkantfäste, spärrhandtag, ledhandtag, svänghandtag, t-stångshandtag, universalknut och förlängare



A7535DZE



165 x 500 x 45 mm



1 A7535DZE

A7400DZ-1/2, A7400DZ-17/32, A7400DZ-1/4, A7400DZ-3/4, A7400DZ-13/16, A7400DZ-19/32, A7400DZ-11/16, A7400DZ-3/8, A7400DZ-7/16, A7400DZ-5/16, A7400DZ-7/8, A7400DZ-9/16, A7400DZ-5/8



7755-3/8



7754



7760, 7762



7766



7758



7752



3/8" hylsnyckelsats med fyrkantfäste, tolvkantprofil och spärrhandtag med runt huvud och förlängare med kula



7429JDE



38 x 150 x 490 mm



1 7429JDE

A7400DM-6, A7400DM-7, A7400DM-8, A7400DM-9, A7400DM-10, A7400DM-11, A7400DM-12, A7400DM-13, A7400DM-14, A7400DM-15, A7400DM-16, A7400DM-17, A7400DM-18, A7400DM-19, A7400DM-20, A7400DM-21, A7400DM-22

7755-3/8

7754

7760

7757

7407H

7766

7409PH-1, 7409PH-2, 7409PH-3

7409F-6.5, 7409F-8

7409M-3, 7409M-4, 7409M-5, 7409M-6, 7409M-8

3/8" sats med hylsor med fyrkantfäste på fästskena, metrisk sexkantprofil



7400SR/



12 35 x 220 x 25 mm



1 7400SR/S12

7400SM-11, 7400SM-10, 7400SM-15, 7400SM-14, 7400SM-13, 7400SM-12, 7400SM-16, 7400SM-9, 7400SM-8, 7400SM-17, 7400SM-19, 7400SM-18

3/8" hylsnyckelsats med fyrkantfäste och metrisk tolvkantprofil på fästskena



7409MB



9



1 7409MB

A7400DM-7, A7400DM-8, A7400DM-10, A7400DM-11, A7400DM-13, A7400DM-15, A7400DM-17, A7400DM-19, A7400DM-22

3/8" sats med långa hylsor med fyrkantfäste och metrisk tolvkantprofil på fästskena



7408MD



8



1 7408MD

A7402DM-10, A7402DM-8, A7402DM-11, A7402DM-12, A7402DM-13, A7402DM-14, A7402DM-17, A7402DM-19

3/8" sats med hylsnycklar med fyrkantfäste, för Torx®-skruv



7400TORX-ER/



7 25 x 55 x 190 mm



1 7400TORX-ER/S7

7400TORX-E14, 7400TORX-E12, 7400TORX-E11, 7400TORX-E10, 7400TORX-E18, 7400TORX-E16, 7400TORX-E8

1/2" sats med långa sexkantshylsor med fyrkantfäste, 12 st.



S1612L



49 x 152 x 280 mm



4 S1612L

Bitshylsats 1/2" för insex-skruv – 9 delar



S9HEX



46 x 130 x 195 mm



10 S9HEX

Bitshylsats 1/2" för TORX®-skruv – 9 delar



S9TORX



46 x 130 x 195 mm



10 S9TORX

Bitshylssats 1/2" för insex-skruv – 18 delar



S18HEX



100 x 210 x 370 mm

4 S18HEX

1/2" Bitshylssats med Torx®-bits – 18 delar



S18TORX



100 x 210 x 370 mm

4 S18TORX

1/2" hylsnyckelsats med fyrkantfäste och sexkantprofil samt spårhandtag



S240



100 x 215 x 375 mm

4 S240

SBS81



8166



8160-5, 8160-10



7772H



8158-10



7800SM-10, 7800SM-11, 7800SM-12, 7800SM-13, 7800SM-14, 7800SM-15, 7800SM-16, 7800SM-17, 7800SM-18, 7800SM-19, 7800SM-20, 7800SM-21, 7800SM-22, 7800SM-23, 7800SM-24, 7800SM-27, 7800SM-30, 7800SM-32



1/2" hylsnyckelsats med fyrkantfäste och sexkantprofil samt U-ringnyckelsats



S400

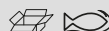

110 x 320 x 375 mm

2 S400

7800SM-10, 7800SM-11, 7800SM-12, 7800SM-13, 7800SM-14, 7800SM-15, 7800SM-16, 7800SM-17, 7800SM-18, 7800SM-19, 7800SM-20, 7800SM-21, 7800SM-22, 7800SM-23, 7800SM-24, 7800SM-25, 7800SM-26, 7800SM-27, 7800SM-28, 7800SM-30, 7800SM-32



SBS81



8160-5, 8160-10



8166



7772H



8158-10



111M-7, 111M-8, 111M-9, 111M-10, 111M-11, 111M-12, 111M-13, 111M-14, 111M-15, 111M-16, 111M-17, 111M-18, 111M-19



1/2" hylsnyckelsats med fyrkantfäste och sexkantprofil samt spårhandtag



S240AF



100 x 215 x 375 mm

4 S240AF

SBS81



8166



8160-5, 8160-10



Hylsnyckelsats 1/2" med u-ringnyckelsats



S350AF



110 x 371 x 313 mm

2 S350AF

S 3/8, S 9/16, S 1.1/4, S 1.1/16, S 1.3/16, S 15/16, S 1.1/8, S 1/2, S 1", S 5/8, S 7/8, S 3/4, S 7/16

815



703/A MP



763, 753



773



PU 3/4, PU 7/16, PU 3/8, PU 1/4, PU 9/16, PU 1/2, PU 11/16, PU 5/16

Sats med 1/2" bitshylsor med fyrkantfäste för insexskruv



7809M/10



45 x 110 x 255 mm

1 7809M/10

7809M-5, 7809M-6, 7809M-7, 7809M-8, 7809M-9, 7809M-10, 7809M-12, 7809M-14, 7809M-17, 7809M-19



Sats med 1/2" bitshylsor med fyrkantsfäste för insexskruv, tum-skala



7809Z/10



45 x 110 x 255 mm



1 7809Z/10

7809Z-3/8, 7809Z-5/16, 7809Z-7/16, 7809Z-1/4, 7809Z-19/32, 7809Z-5/8, 7809Z-17/32, 7809Z-9/16, 7809Z-1/2, 7809Z-3/16



Sats med 1/2" bitshylsor med fyrkantsfäste för Torx®/insexskruv



7809TORX/10



45 x 110 x 255 mm



1 7809TORX/10

7809TORX-T20, 7809TORX-T27, 7809TORX-T25, 7809TORX-T40, 7809TORX-T30, 7809TORX-T45, 7809TORX-T50, 7809TORX-T55



7809M-6, 7809M-8



1/2" hylsnyckelsats med fyrkantsfäste, metrisk sexkantsprofil och spärrhandtag med runt huvud och förlängare



7819SRE



60 x 115 x 280 mm



1 7819SRE

7800SM-17, 7800SM-22, 7800SM-19, 7800SM-24, 7800SM-10, 7800SM-11, 7800SM-12, 7800SM-13



8155-1/2



8160-5



1/2" hylsnyckelsats med fyrkantsfäste, tolvkantsprofil och spärrhandtag med smalt huvud, etui i metall



7814DS



60 x 185 x 445 mm



1 7814DS

7800DM-10, 7800DM-11, 7800DM-12, 7800DM-13, 7800DM-14, 7800DM-15, 7800DM-16, 7800DM-17, 7800DM-18, 7800DM-19



8150SL



8160-5, 8160-10



8166



1/2" hylsnyckelsats med fyrkantsfäste, tolvkantsprofil och T-stångshandtag, etui i formsprutad plastlåda



7818DS



60 x 185 x 445 mm

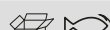

1 7818DS

7800DM-8, 7800DM-10, 7800DM-11, 7800DM-12, 7800DM-13, 7800DM-14, 7800DM-15, 7800DM-16, 7800DM-17, 7800DM-18, 7800DM-19, 7800DM-21, 7800DM-22



8150SL



8160-5, 8160-10



8154-11



8166



1/2" hylsnyckelsats med fyrkantsfäste, sexkantsprofil och spärrhandtag med runt huvud



7818MHR



50 x 185 x 445 mm

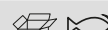

1 7818MHR

7800SM-10, 7800SM-11, 7800SM-12, 7800SM-13, 7800SM-14, 7800SM-15, 7800SM-17, 7800SM-19, 7800SM-22, 7800SM-24, 7800SM-27, 7800SM-30, 7800SM-32



8150RN-1/2



8160-5, 8160-10



8154-11



8166



1/2" hylsnyckelsats med fyrkantsfäste och sexkantsprofil samt spärrhandtag och T-stångshandtag



7825MHP



60 x 185 x 445 mm



1 7825MHP

7800SM-10, 7800SM-11, 7800SM-12, 7800SM-13, 7800SM-14, 7800SM-15, 7800SM-16, 7800SM-17, 7800SM-18, 7800SM-19, 7800SM-20, 7800SM-21, 7800SM-22, 7800SM-23, 7800SM-24, 7800SM-26, 7800SM-27, 7800SM-28, 7800SM-30, 7800SM-32



8150-1/2



8160-5, 8160-10



8154-11



8166



1/2" hylsnyckelsats med fyrkantfäste, tolvkantprofil och spärrhandtag och universalknut



7825MBP

60 x 185 x 445 mm 1 7825MBP

7800DM-10, 7800DM-11, 7800DM-12, 7800DM-13, 7800DM-14, 7800DM-15, 7800DM-16, 7800DM-17, 7800DM-18, 7800DM-19, 7800DM-20, 7800DM-21, 7800DM-22, 7800DM-23, 7800DM-24, 7800DM-26, 7800DM-27, 7800DM-28, 7800DM-30, 7800DM-32	
8150-1/2	
8160-5, 8160-10	
8154-11	
8166	

1/2" hylsnyckelsats med fyrkantfäste, tolvkantprofil och spärrhandtag med runt huvud



7819DRN

51 x 225 x 445 mm 1 7819DRN

7800DM-19, 7800DM-18, 7800DM-17, 7800DM-16, 7800DM-23, 7800DM-22, 7800DM-21, 7800DM-11, 7800DM-10, 7800DM-15, 7800DM-13, 7800DM-14, 7800DM-12, 7800DM-24, 7800DM-26, 7800DM-27, 7800DM-28, 7800DM-30, 7800DM-32	
8150RN-1/2	
8152-1/2	
8166-1/2	
8160-5, 8160-10	
8154-11	
8166	

1/2" hylsnyckelsats med fyrkantfäste, tolvkantprofil och spärrhandtag med päronformat huvud och förlängare



7888DM

73 x 340 x 445 mm 1 7888DM

7800DM-10, 7800DM-11, 7800DM-12, 7800DM-13, 7800DM-14, 7800DM-15, 7800DM-16, 7800DM-17, 7800DM-18, 7800DM-19, 7800DM-20, 7800DM-21, 7800DM-22, 7800DM-23, 7800DM-24, 7800DM-26, 7800DM-27, 7800DM-28, 7800DM-30, 7800DM-32	
8150-1/2	
8154-11	
8160-3, 8160-5, 8160-10	
8166	
8157-15	

Sats med 1/2" hylsnycklar och bitshylsor med fyrkantfäste och metrisk sexkantprofil



7823SE

60 x 185 x 445 mm 1 7823SE

7800SM-10, 7800SM-11, 7800SM-12, 7800SM-13, 7800SM-14, 7800SM-15, 7800SM-17, 7800SM-19, 7800SM-22, 7800SM-24, 7800SM-27, 7800SM-30	
7809M-5, 7809M-6, 7809M-7, 7809M-8, 7809M-10, 7809M-12, 7809M-14	
8155-1/2	
8160-10	
8154-11	
8166	

1/4" och 1/2" hylsnyckelsats med fyrkantfäste och sexkantprofil



7847SS

60 x 225 x 445 mm 1 7847SS

6700SM-5, 6700SM-6, 6700SM-7, 6700SM-8, 6700SM-9, 6700SM-10, 6700SM-11, 6700SM-12, 6700SM-13	
6950SL	
6960, 6962	
6954	
6966	
6956	
59S/PH1, 59S/PH2, 59S/PH3	
59S/PZ1, 59S/PZ2, 59S/PZ3	
59S/0.6-4.5, 59S/0.8-5.5, 59S/1.2-8.0	
59S/H3, 59S/H4, 59S/H5, 59S/H6	
7800SM-10, 7800SM-11, 7800SM-12, 7800SM-13, 7800SM-14, 7800SM-15, 7800SM-17, 7800SM-19, 7800SM-22, 7800SM-24, 7800SM-27, 7800SM-30, 7800SM-32	
8150SL	
6973A	
8160-5, 8160-10	
8154-11	
8166	



1/2" hylsnyckelsats med fyrkantfäste och tolvkantprofil samt spärrhandtag med smalt huvud, tum-skala



7817DZS



60 x 185 x 445 mm



1 7817DZS

7800DZ-3/8, 7800DZ-7/16, 7800DZ-1/2, 7800DZ-9/16, 7800DZ-5/8, 7800DZ-11/16, 7800DZ-3/4, 7800DZ-13/16, 7800DZ-7/8, 7800DZ-15/16, 7800DZ-1, 7800DZ-1.1/8, 7800DZ-1.1/4



8150SL

8160-5, 8160-10

8166

Hylsnyckelsats med tolvkantshylsor med 1/2" fyrkantfäste, i tum-dimensioner samt spärrhandtag med smalt huvud – 13 delar



7817DZS1



60 x 185 x 445 mm



4500 g



1 7817DZS1

7800DZ-3/8, 7800DZ-7/16, 7800DZ-1/2, 7800DZ-9/16, 7800DZ-5/8, 7800DZ-11/16, 7800DZ-3/4, 7800DZ-13/16, 7800DZ-7/8, 7800DZ-15/16, 7800DZ-1, 7800DZ-1.1/8, 7800DZ-1.1/16



8150SL

8160-5, 8160-10

8166

1/2" hylsnyckelsats med fyrkantfäste, tolvkantprofil för tum-skala och spärrhandtag med smalt huvud och T-stångshandtag



7823DZS



60 x 185 x 445 mm



1 7823DZS

7800DZ-3/8, 7800DZ-7/16, 7800DZ-1/2, 7800DZ-9/16, 7800DZ-19/32, 7800DZ-5/8, 7800DZ-11/16, 7800DZ-3/4, 7800DZ-25/32, 7800DZ-13/16, 7800DZ-7/8, 7800DZ-15/16, 7800DZ-1, 7800DZ-1.1/16, 7800DZ-1.1/8, 7800DZ-1.3/16, 7800DZ-1.1/4, 7800DZ-1.5/16



8150SL

8160-5, 8160-10

8154-11

8166

1/2" hylsnyckelsats med fyrkantfäste, tolvkantprofil och spärrhandtag med smalt huvud, etui i polyester



7814DST



60 x 220 x 480 mm



1 7814DST

7800DM-10, 7800DM-11, 7800DM-12, 7800DM-13, 7800DM-14, 7800DM-15, 7800DM-16, 7800DM-17, 7800DM-18, 7800DM-19



8150SL

8160-5, 8160-10

8166

1/2" hylsnyckelsats med fyrkantfäste, tolvkantprofil och T-stångshandtag, etui i polyester



7818DST



60 x 220 x 480 mm



1 7818DST

7800DM-8, 7800DM-10, 7800DM-11, 7800DM-12, 7800DM-13, 7800DM-14, 7800DM-15, 7800DM-16, 7800DM-17, 7800DM-18, 7800DM-19, 7800DM-21, 7800DM-22



8150SL

8160-5, 8160-10

8166

8154-11

1/2" hylsnyckelsats med fyrkantfäste, metrisk sexkantprofil och spärrhandtag med smalt huvud



7818SST



60 x 220 x 480 mm



1 7818SST

7800SM-10, 7800SM-11, 7800SM-12, 7800SM-13, 7800SM-14, 7800SM-15, 7800SM-17, 7800SM-19, 7800SM-22, 7800SM-24, 7800SM-27, 7800SM-30, 7800SM-32



8150SL

8160-1/2, 8162-1/2, 8166-1/2, 8154-1/2

1/2" hylsnyckelsats med fyrkantfäste, sexkantprofil och spärrhandtag med smalt huvud, universalknut



7825SST



65 x 250 x 480 mm

1 7825SST

7800SM-10, 7800SM-11, 7800SM-12, 7800SM-13, 7800SM-14, 7800SM-15, 7800SM-16, 7800SM-17, 7800SM-18, 7800SM-19, 7800SM-20, 7800SM-21, 7800SM-22, 7800SM-23, 7800SM-24, 7800SM-26, 7800SM-27, 7800SM-28, 7800SM-30, 7800SM-32

8150SL

8160-1/2, 8162-1/2, 8166-1/2, 8154-1/2

1/2" hylsnyckelsats med fyrkantfäste, tolvkantprofil och spärrhandtag med smalt huvud



7825DST



65 x 250 x 480 mm

1 7825DST

7800DM-10, 7800DM-11, 7800DM-12, 7800DM-13, 7800DM-14, 7800DM-15, 7800DM-16, 7800DM-17, 7800DM-18, 7800DM-19, 7800DM-20, 7800DM-21, 7800DM-22, 7800DM-23, 7800DM-24, 7800DM-26, 7800DM-27, 7800DM-28

8150SL

8160-1/2, 8162-1/2, 8166-1/2, 8154-1/2

1/2" hylsnyckelsats med fyrkantfäste, tolvkantprofil och spärrhandtag med smalt huvud och ledhandtag



7827DST



65 x 250 x 480 mm

1 7827DST

7800DM-10, 7800DM-11, 7800DM-12, 7800DM-13, 7800DM-14, 7800DM-15, 7800DM-16, 7800DM-17, 7800DM-18, 7800DM-19, 7800DM-20, 7800DM-21, 7800DM-22, 7800DM-23, 7800DM-24, 7800DM-26, 7800DM-27, 7800DM-28, 7800DM-30, 7800DM-32

8150SL

8159-1/2, 8160-1/2, 8162-1/2, 8154-1/2, 8166-1/2, 8158-1/2

Sats med 1/2" hylsnycklar och bitshylsor med fyrkantfäste och metrisk tolvkantprofil



7810MH



10

1 7810MH

7800SM-10, 7800SM-11, 7800SM-13, 7800SM-14, 7800SM-15, 7800SM-16, 7800SM-19, 7800SM-17, 7800SM-21, 7800SM-22

1/2" hylsnyckelsats med fyrkantfäste och metrisk tolvkantprofil – 10 delar/skena



7810MB



10

1 7810MB

7800DM-11, 7800DM-10, 7800DM-14, 7800DM-13, 7800DM-16, 7800DM-17, 7800DM-19, 7800DM-22, 7800DM-21, 7800DM-15

1/2" hylsnyckelsats med fyrkantfäste och metrisk tolvkantprofil – 6 delar/skena



7806MD



6

1 7806MD

7805DM-10, 7805DM-14, 7805DM-13, 7805DM-17, 7805DM-19, 7805DM-22



1/2" sats med hylsor med fyrkantsfäste på fästskena, Torx®-profil



7807TE



7

1 7807TE

7800TORX-E10, 7800TORX-E12,
7800TORX-E14, 7800TORX-E16,
7800TORX-E18, 7800TORX-E20,
7800TORX-E24



3/4" hylsnyckelsats med fyrkantsfäste, tolvkantprofil och spärrhuvud



SLX 17



375 x 430 x 110 mm

1 SLX 17

Hylsnyckelsats 3/4" med sexkanthylsor i tum-dimensioner, spärrhuvud, handtag och förlängare – 17 delar



SLX17AF



70 x 375 x 430 mm

1 SLX 17AF

3/4" hylsnyckelsats med sexkantshylsor med fyrkantsfäste, spärrhandtag med runt huvud, handtag, t-stångshuvud samt förlängare



8845NM



94 x 206 x 591 mm

1 8845NM

8900SM-24, 8900SM-22, 8900SM-27,
8900SM-30, 8900SM-32, 8900SM-36,
8900SM-38, 8900SM-41, 8900SM-46,
8900SM-50



8953



8954A



8962, 8961



8950N/A



Hylsnyckelsats 3/4" med tolvkantshylsor med fyrkantsfäste, runt spärrhuvud och handtag, t-stångshuvud samt förlängare



8845DM



94 x 206 x 591 mm

1 8845DM

8900DM-19, 8900DM-22, 8900DM-24,
8900DM-27, 8900DM-30, 8900DM-32,
8900DM-36, 8900DM-41, 8900DM-46,
8900DM-50



8950N/A



8953



8954A



8961, 8962



Hylsnyckelsats 3/4", tolvkantshylsor med fyrkantsfäste och spärrhandtag med runt huvud



8821MB



95 x 220 x 600 mm

1 8821MB

8950N/A



8954



8965



8966



8961, 8962



8900DM-26, 8900DM-23, 8900DM-22,
8900DM-24, 8900DM-27, 8900DM-29,
8900DM-28, 8900DM-32, 8900DM-30,
8900DM-34, 8900DM-38, 8900DM-35,
8900DM-36, 8900DM-46, 8900DM-41,
8900DM-42, 8900DM-50



Hylsnyckelsats 3/4", med tolvkantshylsor i metriska dimensioner—24 delar



8840M

100 x 210 x 595 mm 1 8840M

8900DM-19, 8900DM-22, 8900DM-24, 8900DM-25, 8900DM-27, 8900DM-28, 8900DM-30, 8900DM-32, 8900DM-36, 8900DM-41, 8900DM-46, 8900DM-50, 8900DM-55, 8900DM-60

- 8953
- 8950N/A
- 8951
- 8954A
- 8958A
- 8962, 8961
- 8966
- 8965
- 8172

1" hylsnyckelsats med hylsor med fyrkantfäste, spärrhandtag med runt huvud, t-stångshandtag



9540MB

210 x 560 x 120 mm 1 9540MB

9500SM-80, 9500SM-75, 9500SM-70, 9500SM-65, 9500SM-60, 9500SM-55, 9500SM-50, 9500SM-46

- 9550AB
- 9555
- 9560AB, 9563AB

1" hylsnyckelsats, sexkantshylsor med fyrkantfäste, spärrhandtag med runt huvud, t-stångshandtag, förminskande adapter och förlängare



9540MBL

225 x 605 x 120 mm 1 9540MBL

9500SM-80, 9500SM-77, 9500SM-71, 9500SM-70, 9500SM-67, 9500SM-65, 9500SM-63, 9500SM-60, 9500SM-75, 9500SM-46, 9500SM-50, 9500SM-54, 9500SM-55, 9500SM-58

- 9550AB
- 9560AB, 9563AB
- 9555

1" hylsnyckelsats med tolvkantshylsor med fyrkantfäste, tum-dimensioner—11 delar



9540DZ

150 x 260 x 670 mm 1 9540DZ

- 9550AB
- 9555
- 9563AB, 9560AB
- 9500DZ-2.3/4, 9500DZ-2.3/8, 9500DZ-2.3/16, 9500DZ-3, 9500DZ-1.13/16, 9500DZ-3.1/8, 9500DZ-2.5/8, 9500DZ-2

Hylsnyckelsats med 1" tolvkantshylsor, i tum-dimensioner – 19 delar



9540DZL

140 x 285 x 630 mm 1 9540DZL

9500DZ-2.1/4, 9500DZ-2.3/4, 9500DZ-2.3/8, 9500DZ-2.1/2, 9500DZ-2.15/16, 9500DZ-2.1/8, 9500DZ-1.7/8, 9500DZ-2.3/16, 9500DZ-3, 9500DZ-1.13/16, 9500DZ-3.1/8, 9500DZ-2.5/8, 9500DZ-2, 9500DZ-2.9/16

- 9550AB
- 9555
- 9563AB, 9560AB
- 9565AB

1/4"

1/4" hylsnyckelsats med fyrkantfäste, sexkantprofil och höglanspolerad yta



6700SM

Dimension	Antal	Modell
4 mm	5	6700SM-4
4.5 mm	5	6700SM-4.5
5 mm	5	6700SM-5
5.5 mm	5	6700SM-5.5
6 mm	5	6700SM-6
7 mm	5	6700SM-7
8 mm	5	6700SM-8
9 mm	5	6700SM-9
10 mm	5	6700SM-10
11 mm	5	6700SM-11
12 mm	5	6700SM-12
13 mm	5	6700SM-13
14 mm	5	6700SM-14
4 mm	1	SB6700SM-4
4.5 mm	1	SB6700SM-4.5
5 mm	1	SB6700SM-5
5.5 mm	1	SB6700SM-5.5
6 mm	1	SB6700SM-6
7 mm	1	SB6700SM-7
8 mm	1	SB6700SM-8
9 mm	1	SB6700SM-9
10 mm	1	SB6700SM-10
11 mm	1	SB6700SM-11
12 mm	1	SB6700SM-12
13 mm	1	SB6700SM-13
14 mm	1	SB6700SM-14

SB: Hängförpackade



1/4" hylsa med fyrkantfäste och sexkantprofil för tum-skala



6700SZ

Ø	SB	Part Number
1/8 in	5	6700SZ-1/8
5/32 in	5	6700SZ-5/32
3/16 in	5	6700SZ-3/16
7/32 in	5	6700SZ-7/32
1/4 in	5	6700SZ-1/4
9/32 in	5	6700SZ-9/32
5/16 in	5	6700SZ-5/16
11/32 in	5	6700SZ-11/32
3/8 in	5	6700SZ-3/8
7/16 in	5	6700SZ-7/16
1/2 in	5	6700SZ-1/2
9/16 in	5	6700SZ-9/16
1/8 in	5	SB6700SZ-1/8
5/32 in	1	SB6700SZ-5/32
3/16 in	1	SB6700SZ-3/16
7/32 in	1	SB6700SZ-7/32
1/4 in	1	SB6700SZ-1/4
9/32 in	1	SB6700SZ-9/32
5/16 in	1	SB6700SZ-5/16
11/32 in	1	SB6700SZ-11/32
3/8 in	1	SB6700SZ-3/8
7/16 in	1	SB6700SZ-7/16
1/2 in	1	SB6700SZ-1/2
9/16 in	1	SB6700SZ-9/16

SB: Hängförpackade

1/4" hylsa med fyrkantfäste, för Torx®-profil



6700TORX-E

Ø	SB	Part Number
E4	5	6700TORX-E4
E5	5	6700TORX-E5
E6	5	6700TORX-E6
E7	5	6700TORX-E7
E8	5	6700TORX-E8
E10	5	6700TORX-E10
E4	1	SB6700TORX-E4
E5	1	SB6700TORX-E5
E6	1	SB6700TORX-E6
E7	1	SB6700TORX-E7
E8	1	SB6700TORX-E8
E10	1	SB6700TORX-E10

SB: Hängförpackade

Hylsor med 1/4" fyrkantfäste, i metrisk dimensioner, för spärrhandtag. För kylanläggningar



R6810M

Ø	SB	Part Number
3,4 mm	5	R6810M-3,4
4 mm	5	R6810M-4
4,5 mm	5	R6810M-4,5
5 mm	5	R6810M-5
6 mm	5	R6810M-6
7 mm	1	R6810M-7
8 mm	5	R6810M-8
9 mm	5	R6810M-9
10 mm	5	R6810M-10

Hylsor med 1/4" fyrkantfäste, i tumdimensioner, för spärrhandtag. För kylanläggningar



R6810Z

Ø	SB	Part Number
3/16 in	1	R6810Z-3/16
7/32 in	1	R6810Z-7/32
1/4 in	1	R6810Z-1/4
5/16 in	1	R6810Z-5/16
3/8 in	1	R6810Z-3/8

Adapter med 1/4" fyrkantfäste för spärrhandtag. För kylanläggningar



R6822Z

Ø	SB	Part Number
	5	R6822Z

Adapter med 1/4" fyrkantfäste, invändig fyrkant till invändig fyrkant



R6967

Ø	SB	Part Number
1/4 in	5	R6967

Adapter med 1/4" fyrkantfäste, utvändig fyrkant till utvändig fyrkant



R6964A



SB	Part Number
1	R6964A

1/4" tolvkantshylsa med fyrkantfäste



A6700DM

Ø	SB	Part Number
5 mm	5	A6700DM-5
5,5 mm	5	A6700DM-5,5
6 mm	5	A6700DM-6
7 mm	5	A6700DM-7
8 mm	5	A6700DM-8
9 mm	5	A6700DM-9
10 mm	5	A6700DM-10
11 mm	5	A6700DM-11
12 mm	5	A6700DM-12
13 mm	5	A6700DM-13
14 mm	5	A6700DM-14
5 mm	1	SBA6700DM-5
5,5 mm	1	SBA6700DM-5,5
6 mm	1	SBA6700DM-6
7 mm	1	SBA6700DM-7
8 mm	1	SBA6700DM-8



		
9 mm	1	SBA6700DM-9
10 mm	1	SBA6700DM-10
11 mm	1	SBA6700DM-11
12 mm	1	SBA6700DM-12
13 mm	1	SBA6700DM-13
14 mm	1	SBA6700DM-14

SB: Hängförpackade

1/4" tolvkantshylsor med fyrkantfäste, tum-dimensioner



A6700DZ



		
3/16 in	5	A6700DZ-3/16
7/32 in	5	A6700DZ-7/32
1/4 in	5	A6700DZ-1/4
9/32 in	5	A6700DZ-9/32
5/16 in	5	A6700DZ-5/16
11/32 in	5	A6700DZ-11/32
3/8 in	5	A6700DZ-3/8
7/16 in	5	A6700DZ-7/16
1/2 in	5	A6700DZ-1/2
9/16 in	5	A6700DZ-9/16
3/16 in	1	SBA6700DZ-3/16
7/32 in	1	SBA6700DZ-7/32
1/4 in	1	SBA6700DZ-1/4
9/32 in	1	SBA6700DZ-9/32
5/16 in	1	SBA6700DZ-5/16
11/32 in	1	SBA6700DZ-11/32
3/8 in	1	SBA6700DZ-3/8
7/16 in	1	SBA6700DZ-7/16
1/2 in	1	SBA6700DZ-1/2
9/16 in	1	SBA6700DZ-9/16

SB: Hängförpackade

1/4" lång tolvkantshylsa med fyrkantfäste, metrisk dimensioner



A6800DM

		
4 mm	1	A6800DM-4
5 mm	1	A6800DM-5
5.5 mm	1	A6800DM-5.5
6 mm	1	A6800DM-6
7 mm	1	A6800DM-7
8 mm	1	A6800DM-8
9 mm	1	A6800DM-9



		
10 mm	1	A6800DM-10
11 mm	1	A6800DM-11
12 mm	1	A6800DM-12
13 mm	1	A6800DM-13
14 mm	1	A6800DM-14
4 mm	1	SBA6800DM-4
5 mm	1	SBA6800DM-5
5.5 mm	1	SBA6800DM-5.5
6 mm	1	SBA6800DM-6
7 mm	1	SBA6800DM-7
8 mm	1	SBA6800DM-8
9 mm	1	SBA6800DM-9
10 mm	1	SBA6800DM-10
11 mm	1	SBA6800DM-11
12 mm	1	SBA6800DM-12
13 mm	1	SBA6800DM-13
14 mm	1	SBA6800DM-14

SB: Hängförpackade

1/4" lång sexkantshylsa med fyrkantfäste, metrisk dimensioner



A6800SM

		
4 mm	1	A6800SM-4
4.5 mm	1	A6800SM-4.5
5 mm	1	A6800SM-5
6 mm	1	A6800SM-6
7 mm	1	A6800SM-7
8 mm	1	A6800SM-8
9 mm	1	A6800SM-9
10 mm	1	A6800SM-10
11 mm	1	A6800SM-11
12 mm	1	A6800SM-12
13 mm	1	A6800SM-13
14 mm	1	A6800SM-14
15 mm	1	A6800SM-15

SB: Hängförpackade

1/4" lång sexkantshylsa med fyrkantfäste, tum-dimensioner





A6800SZ

		
1/8 in	1	A6800SZ-1/8
5/32" in	1	A6800SZ-5/32

1/4" lång tolvkantshylsa med fyrkantfäste, tum-dimensioner



A6800DZ



		
3/16 in	1	A6800DZ-3/16
7/32 in	1	A6800DZ-7/32
1/4 in	1	A6800DZ-1/4
9/32 in	1	A6800DZ-9/32
5/16 in	1	A6800DZ-5/16
11/32 in	1	A6800DZ-11/32
3/8 in	1	A6800DZ-3/8
7/16 in	1	A6800DZ-7/16
1/2 in	1	A6800DZ-1/2
9/16 in	1	A6800DZ-9/16
3/16 in	1	SBA6800DZ-3/16
7/32 in	1	SBA6800DZ-7/32
1/4 in	1	SBA6800DZ-1/4
9/32 in	1	SBA6800DZ-9/32
5/16 in	1	SBA6800DZ-5/16
11/32 in	1	SBA6800DZ-11/32
3/8 in	1	SBA6800DZ-3/8
7/16 in	1	SBA6800DZ-7/16
1/2 in	1	SBA6800DZ-1/2
9/16 in	1	SBA6800DZ-9/16

SB: Hängförpackade

1/4" ledhylsa med fyrkantfäste och tolvkantprofil



A6710DM

		
5.5 mm	1	A6710DM-5.5
6 mm	1	A6710DM-6
7 mm	1	A6710DM-7
8 mm	1	A6710DM-8
9 mm	1	A6710DM-9
10 mm	1	A6710DM-10
11 mm	1	A6710DM-11
12 mm	1	A6710DM-12
13 mm	1	A6710DM-13
14 mm	1	A6710DM-14



1/4" ledhylsa med fyrkantsfäste och tolvkantprofil, tum-dimensioner



A6710DZ

Diagram	Icon	Part No.
3/16 in	1	A6710DZ-3/16
7/32 in	1	A6710DZ-7/32
1/4 in	1	A6710DZ-1/4
9/32 in	1	A6710DZ-9/32
5/16 in	1	A6710DZ-5/16
11/32 in	1	A6710DZ-11/32
3/8 in	1	A6710DZ-3/8
7/16 in	1	A6710DZ-7/16
1/2 in	1	A6710DZ-1/2
9/16 in	1	A6710DZ-9/16

1/4" ledhandtag med fyrkantsfäste och ledat huvud



6958

Diagram	Icon	Part No.
153 mm	1	6958-6
153 mm	1	SB6958-6

SB: Hängförpackade

1/4" fyrkantsfäste för T-stångshandtag



6954

Diagram	Icon	Part No.
125 mm	1	6954
125 mm	10	SB6954

SB: Hängförpackade

1/4" fyrkantsfäste för vridhandtag



6956

Diagram	Icon	Part No.
150 mm	10	6956
150 mm	1	SB6956

SB: Hängförpackade

1/4" förlängare med fyrkantsfäste



6960-6962L

Diagram	Icon	Part No.
50 mm	1	6960
101 mm	1	6961
152 mm	1	6962
355 mm	1	6962L
53 mm	1	SB6960
101 mm	1	SB6961
152 mm	1	SB6962
355 mm	1	SB6962L

1/4" förlängare med kula och fyrkantsfäste



6960-W-6962-W

Diagram	Icon	Part No.
50 mm	10	6960W-2
100 mm	1	6960W-4
150 mm	10	6960W-6

Förlängare 1/4" med räfflat grepp



696EX

Diagram	Icon	Part No.
26 mm	1	696EX-01
152 mm	1	696EX-06
200 mm	1	696EX-08
276 mm	1	696EX-11

1/4" böjbar förlängare med fyrkantsfäste



6963

Diagram	Icon	Part No.
148 mm	1	6963
148 mm	1	SB6963

1/4" fyrkantsfäste med universalknut



6966

Diagram	Icon	Part No.
35 mm	10	6966
35 mm	1	SB6966

SB: Hängförpackade

Universalknut 1/4" med fyrkantsfäste



6968



35 mm



1 6968

1/4" adapter med fyrkantsfäste för 1/4" sexkantsbits



6972H



1/4" in



1/4"



5 6972H

Platt hylsadapter fyrkant 1/4" till 1/4"



6969



1/4



1 6969

Mellanstycke för föröring av 1/4" bitshylsor till 3/8" bitshylsor, med fyrkantsfäste



7765



1/4



3/8



1 7765

1/4

3/8

1 SB7765

1/4" magnetisk adapter med fyrkantsfäste för 1/4" sexkantsbits



6973M



1/4"



1/4" in



1 6973M

Platt mellanstycke för föröring av 1/4" bitshylsor till 3/8" bitshylsor, med fyrkantsfäste



7767



1/4



1 7767

1/4

1 SB7767

SB: Hängförpackade

1/4" fyrkantsfäste till sexkants bitsadapter 1/4"



6709HL



1/4 in



1 6709HL

1/4" adapter med fyrkantsfäste för 1/4" sexkantsbits



6973A



1/4 in



10 6973A

1/4 in

1 SB6973A

SB: Hängförpackade

Sats med tre platta mellanstycken med fyrkantsfäste från 1/4" till 3/8", 3/8" till 1/2", 1/2" till 3/4"



8967/S3



110 x 194 x 30 mm



1 8967/S3

7767

8167

8967



Fästskena för 1/4" 3/8" och 1/2" Clips



RAIL-187/264/340

187 mm	3	RAIL-187
264 mm	3	RAIL-264
340 mm	3	RAIL-340

Clips 1/4" för hylsor och bitshylsor



C1/4

17 mm	25	CLIPS-1/4

1/4" bitshylsa med fyrkantsfäste för spårskruv



6709F

0.6 mm	4.5 mm	5 6709F-4.5
0.8 mm	5.5 mm	5 6709F-5.5
0.9 mm	6.5 mm	5 6709F-6.5
1.2 mm	8 mm	5 6709F-8
0.6 mm	4.5 mm	1 SB6709F-4.5
0.8 mm	5.5 mm	1 SB6709F-5.5
0.9 mm	6.5 mm	1 SB6709F-6.5
1.2 mm	8 mm	1 SB6709F-8

SB: Hängförpackade

1/4" bitshylsor med fyrkantsfäste för Phillips-skruv



6709PH

1	5	6709PH-1
2	5	6709PH-2
3	5	6709PH-3
1	1	SB6709PH-1
2	1	SB6709PH-2
3	1	SB6709PH-3

SB: Hängförpackade

1/4" bitshylsor med fyrkantsfäste för Pozidriv-skruv



6709PZ

1	5	6709PZ-1
2	5	6709PZ-2
3	5	6709PZ-3
1	1	SB6709PZ-1
2	1	SB6709PZ-2
3	1	SB6709PZ-3

SB: Hängförpackade

1/4" bitshylsor med fyrkantsfäste för Torx®-skruv



6709TORX

T6	5	6709TORX-T6
T7	5	6709TORX-T7
T8	5	6709TORX-T8
T9	5	6709TORX-T9
T10	5	6709TORX-T10
T15	5	6709TORX-T15
T20	5	6709TORX-T20
T25	5	6709TORX-T25
T27	5	6709TORX-T27
T30	5	6709TORX-T30

T40	5	6709TORX-T40
T8	1	SB6709TORX-T8
T9	1	SB6709TORX-T9
T10	1	SB6709TORX-T10
T15	1	SB6709TORX-T15
T20	1	SB6709TORX-T20
T25	1	SB6709TORX-T25
T27	1	SB6709TORX-T27
T30	1	SB6709TORX-T30
T40	1	SB6709TORX-T40

SB: Hängförpackade

1/4" bitshylsor med fyrkantsfäste för Torx®-skruv med centrumspets



6709TORX-R

TR 8	1	6709TORX-R-T8
TR 10	1	6709TORX-R-T10
TR 15	1	6709TORX-R-T15
TR 20	1	6709TORX-R-T20
TR 25	1	6709TORX-R-T25
TR 8	1	SB6709TORX-R-T8
TR 10	1	SB6709TORX-R-T10
TR 15	1	SB6709TORX-R-T15
TR 20	1	SB6709TORX-R-T20
TR 25	1	SB6709TORX-R-T25

SB: Hängförpackade

Bitshylsa med fyrkantsfäste 1/4" för Torx Plus®-skruv



6709-IP

IP6		1 6709-IP6
IP7		1 6709-IP7
IP8		1 6709-IP8
IP9		1 6709-IP9
IP10	M3	1 6709-IP10
IP15	-	1 6709-IP15
IP20	M4	1 6709-IP20
IP25	M5	1 6709-IP25
IP27	-	1 6709-IP27
IP30	M6	1 6709-IP30
IP40	M8	1 6709-IP40
IP45	-	1 6709-IP45

SB: Hängförpackade

1/4" bitshylsor med fyrkantsfäste för insexskruv



6709M

3 mm	5	6709M-3
4 mm	5	6709M-4
5 mm	5	6709M-5
6 mm	5	6709M-6
8 mm	5	6709M-8
10 mm	5	6709M-10
3 mm	1	SB6709M-3
4 mm	1	SB6709M-4
5 mm	1	SB6709M-5
6 mm	1	SB6709M-6
8 mm	1	SB6709M-8

SB: Hängförpackade

1/4" lång bitshylsa med fyrkantsfäste, för metrisk insexskruv



A6709M

2.5 mm	1	A6709M-2.5
3 mm	1	A6709M-3
4 mm	1	A6709M-4
5 mm	1	A6709M-5
6 mm	1	A6709M-6
2.5 mm	1	SBA6709M-2.5
3 mm	1	SBA6709M-3
4 mm	1	SBA6709M-4
5 mm	1	SBA6709M-5
6 mm	1	SBA6709M-6

SB: Hängförpackade

1/4" lång bitshylsa med fyrkantsfäste, för insexskruv med tum-dimensioner



A6709Z

1/8 in	1	A6709Z-1/8
9/64 in	1	A6709Z-9/64
5/32 in	1	A6709Z-5/32

3/16 in	1	A6709Z-3/16
1/8 in	1	SBA6709Z-1/8
9/64 in	1	SBA6709Z-9/64
5/32 in	1	SBA6709Z-5/32
3/16 in	1	SBA6709Z-3/16

SB: Hängförpackade

1/4" smalt spärrhandtag med päronformat huvud, 72 tänder och 5° omtagsvinkel



6950SL

119 mm	72	1	6950SL
--------	----	---	--------

1/4" spärrhandtag med päronformat huvud, 72 tänder och 5° omtagsvinkel



6950

121 mm	72	1	6950
121 mm	72	1	SB6950

1/4" spärrhandtag med runt huvud, 72 tänder och 5° omtagsvinkel



6950RN

121 mm	72	1	6950RN
121 mm	72	1	SB6950RN

1/4" spärrhandtag för kylanläggningar, 32 tänder och 11,5° omtagsvinkel



R6950

160 mm	32	1	R6950
--------	----	---	-------

1/4" spärrhandtag med päronformat huvud, 60 tänder och 6° omtagsvinkel



SBS61

145 mm	60	1	SBS61
--------	----	---	-------

SB: Hängförpackade

1/4" spärrhandtag med päronformat huvud, 60 tänder och 6° omtagsvinkel



SBS61S

120 mm	60	1	SBS61S
--------	----	---	--------

SB: Hängförpackade



1/4" spärrhandtag med vridbart huvud, 72 tänder och 5° omtagsvinkel



8120-1/4

149 mm	72	20	8120-1/4

Spärrnyckel för bits



2058-BR

52	1	2058-BR

Adapter för spärrhandtag med 52 tänder för 1/4" spärrhandtag



6951

40 mm	1	6951

Reservdelssats till 6950SL 1/4" spärrhandtag



6950SL-SPARE

10	6950SL	1	6950SL-SPARE

Reservdelssats till 6950 1/4" spärrhandtag



6950-SPARE

12	6950	1	6950-SPARE

Reservdelssats till 6950RN 1/4" spärrhandtag



6950RN-SPARE

6	6950RN	1	6950RN-SPARE

3/8"

3/8" hylsa med fyrkantfäste, metrisk sexkantprofil och höglanspolerad yta



7400SM

6 mm	5	7400SM-6
7 mm	5	7400SM-7
8 mm	5	7400SM-8
9 mm	5	7400SM-9
10 mm	5	7400SM-10
11 mm	5	7400SM-11
12 mm	5	7400SM-12
13 mm	5	7400SM-13
14 mm	5	7400SM-14
15 mm	5	7400SM-15
16 mm	5	7400SM-16
17 mm	5	7400SM-17
18 mm	5	7400SM-18
19 mm	5	7400SM-19
20 mm	5	7400SM-20
21 mm	5	7400SM-21
22 mm	5	7400SM-22
6 mm	1	SB7400SM-6
7 mm	1	SB7400SM-7
8 mm	1	SB7400SM-8
9 mm	1	SB7400SM-9
10 mm	1	SB7400SM-10
11 mm	1	SB7400SM-11
12 mm	1	SB7400SM-12
13 mm	1	SB7400SM-13
14 mm	1	SB7400SM-14
15 mm	1	SB7400SM-15
16 mm	1	SB7400SM-16
17 mm	1	SB7400SM-17
18 mm	1	SB7400SM-18
19 mm	1	SB7400SM-19
20 mm	1	SB7400SM-20
21 mm	1	SB7400SM-21
22 mm	1	SB7400SM-22



SB: Hängförpackade

3/8" tolvkantshylsa med fyrkantfäste, metrisk dimensioner



A7400DM

6 mm	5	A7400DM-6
7 mm	5	A7400DM-7
8 mm	5	A7400DM-8

		
9 mm	5	A7400DM-9
10 mm	5	A7400DM-10
11 mm	5	A7400DM-11
12 mm	5	A7400DM-12
13 mm	5	A7400DM-13
14 mm	5	A7400DM-14
15 mm	5	A7400DM-15
16 mm	5	A7400DM-16
17 mm	5	A7400DM-17
18 mm	5	A7400DM-18
19 mm	5	A7400DM-19
20 mm	5	A7400DM-20
21 mm	5	A7400DM-21
22 mm	5	A7400DM-22
24 mm	5	A7400DM-24



6 mm	1	SBA7400DM-6
7 mm	1	SBA7400DM-7
8 mm	1	SBA7400DM-8
9 mm	1	SBA7400DM-9
10 mm	1	SBA7400DM-10
11 mm	1	SBA7400DM-11
12 mm	1	SBA7400DM-12
13 mm	1	SBA7400DM-13
14 mm	1	SBA7400DM-14
15 mm	1	SBA7400DM-15
16 mm	1	SBA7400DM-16
17 mm	1	SBA7400DM-17
18 mm	1	SBA7400DM-18
19 mm	1	SBA7400DM-19
20 mm	1	SBA7400DM-20
21 mm	1	SBA7400DM-21
22 mm	1	SBA7400DM-22

SB: Hängförpackade

3/8" hylsa med fyrkantfäste och sexkantprofil för tum-skala





7400SZ

		
1/4" in	1	7400SZ-1/4
5/16" in	1	7400SZ-5/16
11/32" in	1	7400SZ-11/32
3/8" in	1	7400SZ-3/8
7/16" in	1	7400SZ-7/16
1/2" in	1	7400SZ-1/2
9/16" in	1	7400SZ-9/16
5/8" in	1	7400SZ-5/8
11/16" in	1	7400SZ-11/16
3/4" in	1	7400SZ-3/4
13/16" in	1	7400SZ-13/16
7/8" in	1	7400SZ-7/8

3/8" tolvkantshylsa med fyrkantfäste, tum-dimensioner



A7400DZ



		
1/4 in	5	A7400DZ-1/4
5/16 in	5	A7400DZ-5/16
3/8 in	5	A7400DZ-3/8
7/16 in	5	A7400DZ-7/16
1/2 in	5	A7400DZ-1/2
17/32 in	5	A7400DZ-17/32
9/16 in	5	A7400DZ-9/16
19/32 in	5	A7400DZ-19/32
5/8 in	5	A7400DZ-5/8
11/16 in	5	A7400DZ-11/16
3/4 in	5	A7400DZ-3/4
13/16 in	5	A7400DZ-13/16
7/8 in	5	A7400DZ-7/8
1/4 in	1	SBA7400DZ-1/4
5/16 in	1	SBA7400DZ-5/16
3/8 in	1	SBA7400DZ-3/8
7/16 in	1	SBA7400DZ-7/16
1/2 in	1	SBA7400DZ-1/2
17/32 in	1	SBA7400DZ-17/32
9/16 in	1	SBA7400DZ-9/16
19/32 in	1	SBA7400DZ-19/32
5/8 in	1	SBA7400DZ-5/8
11/16 in	1	SBA7400DZ-11/16
3/4 in	1	SBA7400DZ-3/4
13/16 in	1	SBA7400DZ-13/16
7/8 in	1	SBA7400DZ-7/8



SB: Hängförpackade

3/8" ledhylsa med fyrkantfäste och tolvkantprofil, tum-dimensioner



A7410DZ



		
5/16 in	1	A7410DZ-5/16
3/8 in	1	A7410DZ-3/8
7/16 in	1	A7410DZ-7/16
1/2 in	1	A7410DZ-1/2

		
9/16 in	1	A7410DZ-9/16
5/8 in	1	A7410DZ-5/8
11/16 in	1	A7410DZ-11/16
3/4 in	1	A7410DZ-3/4

3/8" lång tolvkantshylsa med fyrkantfäste, metriska dimensioner



A7402DM

		
7 mm	1	A7402DM-7
8 mm	1	A7402DM-8
9 mm	1	A7402DM-9
10 mm	1	A7402DM-10
11 mm	1	A7402DM-11
12 mm	1	A7402DM-12
13 mm	1	A7402DM-13
14 mm	1	A7402DM-14
15 mm	1	A7402DM-15
16 mm	1	A7402DM-16
17 mm	1	A7402DM-17
18 mm	1	A7402DM-18
19 mm	1	A7402DM-19
21 mm	1	A7402DM-21
7 mm	1	SBA7402DM-7
8 mm	1	SBA7402DM-8
9 mm	1	SBA7402DM-9
10 mm	1	SBA7402DM-10
11 mm	1	SBA7402DM-11
12 mm	1	SBA7402DM-12
13 mm	1	SBA7402DM-13
14 mm	1	SBA7402DM-14
15 mm	1	SBA7402DM-15
16 mm	1	SBA7402DM-16
17 mm	1	SBA7402DM-17
18 mm	1	SBA7402DM-18
19 mm	1	SBA7402DM-19

SB: Hängförpackade



3/8" lång tolvkantshylsa med fyrkantfäste, tum-dimensioner



A7402DZ



1/4 in	1	A7402DZ-1/4
5/16 in	1	A7402DZ-5/16
3/8 in	1	A7402DZ-3/8
7/16 in	1	A7402DZ-7/16
1/2 in	1	A7402DZ-1/2
9/16 in	1	A7402DZ-9/16
19/32 in	1	A7402DZ-19/32
5/8 in	1	A7402DZ-5/8
11/16 in	1	A7402DZ-11/16
3/4 in	1	A7402DZ-3/4
13/16 in	1	A7402DZ-13/16
7/8 in	1	A7402DZ-7/8
1/4 in	1	SBA7402DZ-1/4
5/16 in	1	SBA7402DZ-5/16
3/8 in	1	SBA7402DZ-3/8
7/16 in	1	SBA7402DZ-7/16
1/2 in	1	SBA7402DZ-1/2
9/16 in	1	SBA7402DZ-9/16
19/32 in	1	SBA7402DZ-19/32
5/8 in	1	SBA7402DZ-5/8
11/16 in	1	SBA7402DZ-11/16
3/4 in	1	SBA7402DZ-3/4
13/16 in	1	SBA7402DZ-13/16
7/8 in	1	SBA7402DZ-7/8

SB: Hängförpackade

3/8" hylsa med fyrkantfäste, för Torx®-profil



7400TORX-E



E8	5	7400TORX-E8
E10	5	7400TORX-E10
E11	5	7400TORX-E11
E12	5	7400TORX-E12
E14	5	7400TORX-E14
E16	5	7400TORX-E16
E18	5	7400TORX-E18
E8	1	SB7400TORX-E8
E10	1	SB7400TORX-E10
E11	1	SB7400TORX-E11
E12	1	SB7400TORX-E12
E14	1	SB7400TORX-E14
E16	1	SB7400TORX-E16
E18	1	SB7400TORX-E18

SB: Hängförpackade

3/8" svängbart stålhandtag med fyrkantfäste



7752



435 mm

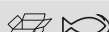

1 7752

3/8" ledhandtag med fyrkantfäste, matt yta



S705



246 mm



1 SBS705

3/8" fyrkantfäste för T-stångshandtag



7754



160 mm



1 7754

160 mm

1 SB7754

SB: Hängförpackade

3/8" fyrkantfäste för vridhandtag



7757



150 mm

150 mm



6 7756

1 SB7756

SB – levereras hängförpackad på blisterkort

3/8" förlängare med fyrkantfäste



7760-7761-7762



75 mm

127 mm

250 mm

75 mm

127 mm

252 mm



1 7760

1 7761

1 7762

1 SB7760

1 SB7761

1 SB7762

3/8" förlängare med kula och fyrkantfäste



7760-W-7761-W



75 mm

150 mm



10 7760W-3

10 7760W-6

3/8" räfflade förlängare med fyrkantfäste



776EX

L	1	776EX-01
26 mm	1	776EX-01
76 mm	1	776EX-03
101 mm	1	776EX-04
150 mm	1	776EX-06
200 mm	1	776EX-08
275 mm	1	776EX-11

3/8" böjbar förlängare med fyrkantfäste

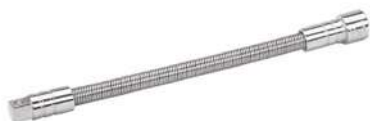

7759

L	1	7759
200 mm	1	7759
200 mm	1	SB7759

3/8" universalknut med fyrkantfäste



7766

L	1	7766
51.5 mm	1	7766
51.5 mm	1	SB7766

SB: Hängförpackade

Universalknut 3/8" med fyrkantfäste



7768

L	1	7768
45 mm	1	7768

Mellanstycke med fyrkantfäste, hylsförminskning från 3/8" till 1/4"



7764

3/8"	1/4"	1	7764
3/8"	1/4"	1	7764
3/8"	1/4"	1	SB7764

Mellanstycke för förstoring 3/8" fyrkantstapp till 1/2" hylsa



8164-1/2

3/8"	1/2"	1	8164-1/2
3/8"	1/2"	1	8164-1/2

Platt mellanstycke för förstoring av 3/8" fyrkant till 1/2" hylsa



8167

3/8"	1/2"	1	8167
3/8"	1/2"	1	8167

Adapter med 3/8" fyrkantfäste för 1/4" sexkantbits



SBS780

1/4 in	1	SBS780
1/4 in	1	SBS780

3/8" adapter med fyrkantfäste för 5/16" sexkantbits



7106J

5/16 in	1	7106J
5/16 in	1	7106J



Clips 3/8" för hylsor och bitshylsor



C3/8

19 mm	25	CLIPS-3/8

3/8" spärrhandtag med päronformat huvud, 80 tänder och 4,5° omtagsvinkel



7750

207 mm	80	1	7750
207 mm	80	1	SB7750

3/8" spärrhandtag med vridbart huvud, 72 tänder och 5° omtagsvinkel



8120-3/8

223 mm	72	10	8120-3/8

ERGO™ 3/8" spärrhandtag med 72 tänder och 5° omtagsvinkel



ergo



7755-3/8

215 mm	72	1	SB7755-3/8

3/8" spärrhandtag med runt huvud, 72 tänder och 5° omtagsvinkel



7750RN

206 mm	72	1	7750RN
206 mm	72	1	SB7750RN

3/8" ledat spärrhandtag med 60 tänder och 6° omtagsvinkel



7710

278 mm	60	1	7710

3/8" spärrhandtag med smalt huvud, 72 tänder och 5° omtagsvinkel



7750SL

204 mm	72	1	7750SL

3/8" spärrhandtag med päronformat huvud, 60 tänder och 6° omtagsvinkel



SBS750

200 mm	60	10	SBS750

SB: Hängförpackade

3/8" bitshylsa med fyrkantfäste för spårskruv



7409F

6.4 mm	5	7409F-6.5
7.9 mm	5	7409F-8
9.5 mm	5	7409F-10
6.4 mm	1	SB7409F-6.5
7.9 mm	1	SB7409F-8
9.5 mm	1	SB7409F-10

SB: Hängförpackade

3/8" bitshylsor med fyrkantsfäste för Phillips-skruv



7409PH

1	5	7409PH-1		
2	5	7409PH-2		
3	5	7409PH-3		
1	1	SB7409PH-1		
2	1	SB7409PH-2		
3	1	SB7409PH-3		

SB: Hängförpackade

3/8" bitshylsor med fyrkantsfäste för Torx®-skruv



7409TORX

T20	5	7409TORX-T20		
T25	5	7409TORX-T25		
T27	5	7409TORX-T27		
T30	5	7409TORX-T30		
T40	5	7409TORX-T40		
T45	5	7409TORX-T45		
T50	5	7409TORX-T50		
T20	1	SB7409TORX-T20		
T25	1	SB7409TORX-T25		
T27	1	SB7409TORX-T27		
T30	1	SB7409TORX-T30		
T40	1	SB7409TORX-T40		
T45	1	SB7409TORX-T45		
T50	1	SB7409TORX-T50		

SB: Hängförpackade

3/8" bitshylsor med fyrkantsfäste för Torx®-skruv med centrumspets



7409TORX-R

TR 27	5	7409TORX-R-T27		
TR 30	5	7409TORX-R-T30		
TR 40	5	7409TORX-R-T40		
TR 45	5	7409TORX-R-T45		
TR 50	5	7409TORX-R-T50		
TR 27	1	SB7409TORX-R-T27		
TR 30	1	SB7409TORX-R-T30		
TR 40	1	SB7409TORX-R-T40		
TR 45	1	SB7409TORX-R-T45		
TR 50	1	SB7409TORX-R-T50		

SB: Hängförpackade

3/8" sats med bitshylsor med fyrkantsfäste för Torx®-skruv med centrumspets



7409TORX-TRR/

5	25 x 55 x 190 mm	1 7409TORX-TRR/S5

7409TORX-R-T40, 7409TORX-R-T30, 7409TORX-R-T27, 7409TORX-R-T50, 7409TORX-R-T45

3/8" långa bitshylsor med fyrkantsfäste för Torx®-skruv



7409TORX-L

T25	5	7409TORX-T25-L		
T30	5	7409TORX-T30-L		
T40	5	7409TORX-T40-L		
T45	5	7409TORX-T45-L		
T50	5	7409TORX-T50-L		

T25	1	SB7409TORX-T25-L		
T30	1	SB7409TORX-T30-L		
T40	1	SB7409TORX-T40-L		
T45	1	SB7409TORX-T45-L		
T50	1	SB7409TORX-T50-L		

SB: Hängförpackade

3/8" bitshylsa med fyrkantsfäste för insexskruv



7409M

3 mm	5	7409M-3		
4 mm	5	7409M-4		
5 mm	5	7409M-5		
6 mm	5	7409M-6		
7 mm	5	7409M-7		
8 mm	5	7409M-8		
10 mm	5	7409M-10		
3 mm	1	SB7409M-3		
4 mm	1	SB7409M-4		
5 mm	1	SB7409M-5		
6 mm	1	SB7409M-6		
7 mm	1	SB7409M-7		
8 mm	1	SB7409M-8		
10 mm	1	SB7409M-10		

SB: Hängförpackade

3/8" bitshylsor med fyrkantsfäste samt kula för insexskruv



7409BH

4 mm	5	7409BH-4		
5 mm	1	7409BH-5		
6 mm	5	7409BH-6		
8 mm	5	7409BH-8		
10 mm	5	7409BH-10		
4 mm	1	SB7409BH-4		
5 mm	1	SB7409BH-5		
6 mm	1	SB7409BH-6		
8 mm	1	SB7409BH-8		
10 mm	1	SB7409BH-10		

SB: Hängförpackade



Genomgående hylsa 19 mm fäste i metrisk dimensioner



SBS19-TH



10 mm	1	SBS19-TH10
11 mm	1	SBS19-TH11
12 mm	1	SBS19-TH12
13 mm	1	SBS19-TH13
14 mm	1	SBS19-TH14
15 in	1	SBS19-TH15
16 mm	1	SBS19-TH16
17 in	1	SBS19-TH17
18 mm	1	SBS19-TH18
19 mm	1	SBS19-TH19
21 mm	1	SBS19-TH21
22 mm	1	SBS19-TH22
24 mm	1	SBS19-TH24

SB: Hängförpackade

3/8" bitshylsor med fyrkantsfäste för insexskruv



7409Z



1/8 in	47 mm	1	7409Z-1/8
5/32 in	47 mm	1	7409Z-5/32
3/16 in	47 mm	1	7409Z-3/16
7/32 in	47 mm	1	7409Z-7/32
1/4 in	47 mm	1	7409Z-1/4
3/8 in	50.5 mm	1	7409Z-3/8

Sats med 3/8" bitshylsor med fyrkantsfäste för insexskruv



7409MR/



7	25 x 55 x 190 mm	1	7409MR/S7
---	------------------	---	-----------

7409M-3, 7409M-4, 7409M-10, 7409M-8, 7409M-7, 7409M-6, 7409M-5



Adapter för spärrhandtag med 52 tänder för 3/8" spärrhandtag



7751



55 mm	175 g	10	7751
-------	-------	----	------

Reservdelssats till 7755-3/8 3/8" spärrhandtag



7755-SO/1



6	7755-3/8	1	7755-SO/1
---	----------	---	-----------

Reservdelssats till 7750SL 3/8" spärrhandtag



7750SL-SPARE



12	7750SL	1	7750SL-SPARE
----	--------	---	--------------

Reservdelssats till 7750 3/8" spärrhandtag



7750-SPARE



11	7750	1	7750-SPARE
----	------	---	------------

Reservdelssats till 7750RN 3/8" spärrhandtag



7750RN-SPARE



6	7750RN	1	7750RN-SPARE
---	--------	---	--------------

1/2"

1/2" hylsa med fyrkantsfäste, sexkantsprofil och högljanspolerad yta



7800SM



8 mm	10	7800SM-8
9 mm	10	7800SM-9
10 mm	10	7800SM-10
11 mm	10	7800SM-11
12 mm	10	7800SM-12
13 mm	10	7800SM-13
14 mm	10	7800SM-14

Ø			
15 mm	10	7800SM-15	
16 mm	10	7800SM-16	
17 mm	10	7800SM-17	
18 mm	10	7800SM-18	
19 mm	10	7800SM-19	
20 mm	10	7800SM-20	
21 mm	10	7800SM-21	
22 mm	10	7800SM-22	
23 mm	10	7800SM-23	
24 mm	10	7800SM-24	
25 mm	10	7800SM-25	
26 mm	10	7800SM-26	
27 mm	10	7800SM-27	
28 mm	10	7800SM-28	
29 mm	10	7800SM-29	
30 mm	10	7800SM-30	
32 mm	10	7800SM-32	
33 mm	10	7800SM-33	
34 mm	10	7800SM-34	
36 mm	10	7800SM-36	
8 mm	1	SB7800SM-8	
9 mm	1	SB7800SM-9	
10 mm	1	SB7800SM-10	
11 mm	1	SB7800SM-11	
12 mm	1	SB7800SM-12	
13 mm	1	SB7800SM-13	
14 mm	1	SB7800SM-14	
15 mm	1	SB7800SM-15	
16 mm	1	SB7800SM-16	
17 mm	1	SB7800SM-17	
18 mm	1	SB7800SM-18	
19 mm	1	SB7800SM-19	
21 mm	1	SB7800SM-20	
21 mm	1	SB7800SM-21	
22 mm	1	SB7800SM-22	
23 mm	1	SB7800SM-23	
24 mm	1	SB7800SM-24	
25 mm	1	SB7800SM-25	
26 mm	1	SB7800SM-26	
27 mm	1	SB7800SM-27	
28 mm	1	SB7800SM-28	
29 mm	1	SB7800SM-29	
30 mm	1	SB7800SM-30	
32 mm	1	SB7800SM-32	
33 mm	1	SB7800SM-33	
34 mm	1	SB7800SM-34	
36 mm	1	SB7800SM-36	

SB: Hängförpackade

1/2" lång hylsa med fyrkantfäste och metrisk sexkantprofil



7805SM

Ø			
10 mm	10	7805SM-10	
11 mm	10	7805SM-11	
12 mm	10	7805SM-12	
13 mm	10	7805SM-13	

Ø			
14 mm	10	7805SM-14	
15 mm	10	7805SM-15	
16 mm	10	7805SM-16	
17 mm	10	7805SM-17	
18 mm	10	7805SM-18	
19 mm	10	7805SM-19	
20 mm	10	7805SM-20	
21 mm	10	7805SM-21	
22 mm	10	7805SM-22	
23 mm	10	7805SM-23	
24 mm	10	7805SM-24	
25 mm	10	7805SM-25	
26 mm	10	7805SM-26	
27 mm	10	7805SM-27	
28 mm	10	7805SM-28	
29 mm	10	7805SM-29	
30 mm	10	7805SM-30	
32 mm	10	7805SM-32	
34 mm	10	7805SM-34	
10 mm	1	SB7805SM-10	
12 mm	1	SB7805SM-12	
13 mm	1	SB7805SM-13	
14 mm	1	SB7805SM-14	
15 mm	1	SB7805SM-15	
16 mm	1	SB7805SM-16	
17 mm	1	SB7805SM-17	
18 mm	1	SB7805SM-18	
19 mm	1	SB7805SM-19	
20 mm	1	SB7805SM-20	
21 mm	1	SB7805SM-21	
22 mm	1	SB7805SM-22	
23 mm	1	SB7805SM-23	
24 mm	1	SB7805SM-24	
25 mm	1	SB7805SM-25	
26 mm	1	SB7805SM-26	
27 mm	1	SB7805SM-27	
28 mm	1	SB7805SM-28	
29 mm	1	SB7805SM-29	
30 mm	1	SB7805SM-30	
32 mm	1	SB7805SM-32	
34 mm	1	SB7805SM-34	

SB: Hängförpackade

1/2" lång hylsa med fyrkantfäste och tolvkantprofil för tum-skala



7805SZ

Ø			
1.3/16 in	1	7805SZ-1.3/16	
1.1/4 in	1	7805SZ-1.1/4	
1.5/16 in	1	7805SZ-1.5/16	
1.3/8 in	1	7805SZ-1.3/8	
1.7/16 in	1	7805SZ-1.7/16	
1.1/2 in	1	7805SZ-1.1/2	

1/2" hylsa med fyrkantfäste och tolvkantprofil



7800DM

Ø			
8 mm	10	7800DM-8	
9 mm	10	7800DM-9	
10 mm	10	7800DM-10	
11 mm	10	7800DM-11	
12 mm	10	7800DM-12	
13 mm	10	7800DM-13	
14 mm	10	7800DM-14	
15 mm	10	7800DM-15	
16 mm	10	7800DM-16	
17 mm	10	7800DM-17	
18 mm	10	7800DM-18	
19 mm	10	7800DM-19	
20 mm	10	7800DM-20	
21 mm	10	7800DM-21	
22 mm	10	7800DM-22	
23 mm	10	7800DM-23	
24 mm	10	7800DM-24	
25 mm	10	7800DM-25	
26 mm	10	7800DM-26	
27 mm	10	7800DM-27	
28 mm	10	7800DM-28	
29 mm	10	7800DM-29	
30 mm	10	7800DM-30	
31 mm	10	7800DM-31	
32 mm	10	7800DM-32	
33 mm	10	7800DM-33	
34 mm	10	7800DM-34	
36 mm	10	7800DM-36	

8 mm	1	SB7800DM-8	
9 mm	1	SB7800DM-9	
10 mm	1	SB7800DM-10	
11 mm	1	SB7800DM-11	
12 mm	1	SB7800DM-12	
13 mm	1	SB7800DM-13	
14 mm	1	SB7800DM-14	
15 mm	1	SB7800DM-15	
16 mm	1	SB7800DM-16	
17 mm	1	SB7800DM-17	
18 mm	1	SB7800DM-18	
19 mm	1	SB7800DM-19	
21 mm	1	SB7800DM-20	
21 mm	1	SB7800DM-21	
22 mm	1	SB7800DM-22	
23 mm	1	SB7800DM-23	
24 mm	1	SB7800DM-24	
25 mm	1	SB7800DM-25	
26 mm	1	SB7800DM-26	
27 mm	1	SB7800DM-27	
28 mm	1	SB7800DM-28	
29 mm	1	SB7800DM-29	
30 mm	1	SB7800DM-30	
31 mm	1	SB7800DM-31	
32 mm	1	SB7800DM-32	
33 mm	1	SB7800DM-33	
34 mm	1	SB7800DM-34	
36 mm	1	SB7800DM-36	

SB: Hängförpackade



1/2" lång hylsa med fyrkantfäste och tolvkantprofil för tum-skala



7800DZ

5/16 in	10	7800DZ-5/16	
11/32 in	10	7800DZ-11/32	
3/8 in	10	7800DZ-3/8	
13/32 in	10	7800DZ-13/32	
7/16 in	10	7800DZ-7/16	
1/2 in	10	7800DZ-1/2	
9/16 in	10	7800DZ-9/16	
19/32 in	10	7800DZ-19/32	
5/8 in	10	7800DZ-5/8	
11/16 in	10	7800DZ-11/16	
3/4 in	10	7800DZ-3/4	
25/32 in	10	7800DZ-25/32	
13/16 in	10	7800DZ-13/16	
7/8 in	10	7800DZ-7/8	
15/16 in	10	7800DZ-15/16	
1 in	10	7800DZ-1	
1.1/16 in	10	7800DZ-1.1/16	
1.1/8 in	10	7800DZ-1.1/8	
1.3/16 in	10	7800DZ-1.3/16	
1.1/4 in	10	7800DZ-1.1/4	
1.5/16 in	10	7800DZ-1.5/16	
1.3/8 in	10	7800DZ-1.3/8	
1.7/16 in	10	7800DZ-1.7/16	
1.1/2 in	10	7800DZ-1.1/2	
3/8 in	1	SB7800DZ-3/8	
7/16 in	1	SB7800DZ-7/16	
1/2 in	1	SB7800DZ-1/2	
9/16 in	1	SB7800DZ-9/16	
19/32 in	1	SB7800DZ-19/32	
5/8 in	1	SB7800DZ-5/8	
11/16 in	1	SB7800DZ-11/16	
3/4 in	1	SB7800DZ-3/4	
25/32 in	1	SB7800DZ-25/32	
13/16 in	1	SB7800DZ-13/16	
7/8 in	1	SB7800DZ-7/8	
15/16 in	1	SB7800DZ-15/16	
1 in	1	SB7800DZ-1	
1.1/16 in	1	SB7800DZ-1.1/16	
1.1/8 in	1	SB7800DZ-1.1/8	
1.3/16 in	1	SB7800DZ-1.3/16	
1.1/4 in	1	SB7800DZ-1.1/4	
1.5/16 in	1	SB7800DZ-1.5/16	

SB: Hängförpackade

1/2" lång hylsa med fyrkantfäste och tolvkantprofil



7805DM

10 mm	10	7805DM-10	
12 mm	10	7805DM-12	
13 mm	10	7805DM-13	

14 mm	10	7805DM-14	
15 mm	10	7805DM-15	
16 mm	10	7805DM-16	
17 mm	10	7805DM-17	
18 mm	10	7805DM-18	
19 mm	10	7805DM-19	
21 mm	10	7805DM-21	
22 mm	10	7805DM-22	
23 mm	10	7805DM-23	
24 mm	10	7805DM-24	
26 mm	10	7805DM-26	
27 mm	10	7805DM-27	
30 mm	10	7805DM-30	
32 mm	10	7805DM-32	
34 mm	10	7805DM-34	

10 mm	1	SB7805DM-10	
12 mm	1	SB7805DM-12	
13 mm	1	SB7805DM-13	
14 mm	1	SB7805DM-14	
15 mm	1	SB7805DM-15	
16 mm	1	SB7805DM-16	
17 mm	1	SB7805DM-17	
18 mm	1	SB7805DM-18	
19 mm	1	SB7805DM-19	
21 mm	1	SB7805DM-21	
22 mm	1	SB7805DM-22	
23 mm	1	SB7805DM-23	
24 mm	1	SB7805DM-24	
26 mm	1	SB7805DM-26	
27 mm	1	SB7805DM-27	
30 mm	1	SB7805DM-30	
32 mm	1	SB7805DM-32	

SB: Hängförpackade

1/2" hylsa med fyrkantfäste och tolvkantprofil för tum-skala



7805DZ

5/8 in	10	7805DZ-5/8	
11/16 in	10	7805DZ-11/16	
3/4 in	10	7805DZ-3/4	
13/16 in	10	7805DZ-13/16	
7/8 in	10	7805DZ-7/8	
15/16 in	10	7805DZ-15/16	
1 in	10	7805DZ-1	
1.1/16 in	10	7805DZ-1.1/16	
1.1/8 in	10	7805DZ-1.1/8	
1.13/16 in	10	7805DZ-1.3/16	
1.1/4 in	10	7805DZ-1.1/4	
1.5/16 in	10	7805DZ-1.5/16	
1.3/8 in	10	7805DZ-1.3/8	
1.7/16 in	10	7805DZ-1.7/16	
1.1/2 in	10	7805DZ-1.1/2	

1/2" hylsa med fyrkantfäste, för Torx®-profil



7800TORX-E

E8	1	7800TORX-E8	
E10	1	7800TORX-E10	
E11	1	7800TORX-E11	
E12	1	7800TORX-E12	
E14	1	7800TORX-E14	
E16	1	7800TORX-E16	
E18	1	7800TORX-E18	
E20	1	7800TORX-E20	
E24	1	7800TORX-E24	
E8	1	SB7800TORX-E8	
E10	1	SB7800TORX-E10	
E11	1	SB7800TORX-E11	
E12	1	SB7800TORX-E12	
E14	1	SB7800TORX-E14	
E16	1	SB7800TORX-E16	
E18	1	SB7800TORX-E18	
E20	1	SB7800TORX-E20	
E24	1	SB7800TORX-E24	

SB: Hängförpackade

1/2" svängbart stålhandtag med fyrkantfäste



8152-1/2

425 mm	1	8152-1/2	

1/2" ledhandtag med fyrkantfäste



8157

257 mm	1	8156-1/2	
257 mm	1	8157-10	
390 mm	1	8157-15	
600 mm	1	8157-24	
900 mm	1	8157-36	

L	
257 mm	1 SB8157-10
390 mm	1 SB8157-15
600 mm	1 SB8157-24
900 mm	1 SB8157-36

1/2" ledhandtag med fyrkantfäste, matt yta



8158

L	
270 mm	1 8158-10
390 mm	1 8158-15
270 mm	1 SB8158-10
390 mm	1 SB8158-15

Vinkelhandtag med 1/2" fyrkantfäste



8167-1/2

L	
210 mm	1 8167-1/2

T-stångshandtag med 1/2" fyrkantfäste



8154

L	
280 mm	10 8154-11
280 mm	1 SB8154-11

Adapter 3/8" till 1/2", flyttbart huvud



7772H

3/8"	1/2"	10	7772H

1/2" förlängare med fyrkantfäste



8160

L	
88 mm	10 8160-3
125 mm	10 8160-5
250 mm	10 8160-10
88 mm	1 SB8160-3
125 mm	1 SB8160-5
250 mm	1 SB8160-10

1/2" förlängare med vridbart fyrkantfäste



8159-W-8162-W

L	
75 mm	10 8160W-3
125 mm	10 8160W-5
250 mm	10 8160W-10

1/2" förlängare med fyrkantfäste



8160-B

L	
125 mm	1 8160-B

1/2" universalknut med fyrkantfäste



8166

L	
72 mm	10 8166
72 mm	1 SB8166

Universalknut 1/2" med fyrkantfäste, för smidig användning



8168

L	
62 mm	1 8168



Mellanstycke med fyrkantsfäste, förminskning från 1/2" till 3/8" hylsa



8171

1/2"	3/8"	10	8171
1/2"	3/8"	1	SB8171

Platt mellanstycke för förstoring av 1/2" fyrkant till 3/4" fyrkant



8967

1/2	3/4	1	8967

Reservdelssats för 8169-1/2 ledhandtag



SP120

75 g	1 SP120

Stegtapp, för invändiga sexkantsfästen



8195-key

140 g	50 8195-KEY

Används med 8195-R

1/2" adapter med fyrkantsfäste för 5/16" sexkantsbits



7106S

5/16 in	10 8174A

Reservdelssats för 8170-1/2 ledhandtag



SP120XL

55 g	1 SP120XL

Mellanstycke för förstoring av 1/2" bitshylsor till 3/4" bitshylsor, med fyrkantsfäste



8172

1/2"	3/4"	10	8172
1/2"	3/4"	1	SB8172

1/2" adapter med fyrkantsfäste för 5/16" sexkantsbits



7809HL

5/16 in	1 7809HL

Clips 1/2" för hylsor och bitshylsor



C1/2

19 mm	25 CLIPS-1/2

1/2" bitshylsor med fyrkantfäste för spårskruv



7809F

0,8 mm	8 mm	5 7809F-8
1 mm	10 mm	5 7809F-10

1/2" bitshylsor med fyrkantfäste för Phillips-skriv



7809PH

2	1 7809PH-2
3	1 7809PH-3
4	1 7809PH-4

1/2" bitshylsor med fyrkantfäste för Pozidriv-skriv



7809PZ

2	1 7809PZ-2
3	1 7809PZ-3

1/2" bitshylsor med fyrkantfäste för Torx®-skriv



7809TORX

T20	1 7809TORX-T20
T25	1 7809TORX-T25
T27	1 7809TORX-T27
T30	1 7809TORX-T30
T40	1 7809TORX-T40
T45	1 7809TORX-T45
T50	1 7809TORX-T50
T55	1 7809TORX-T55
T60	1 7809TORX-T60
T20	1 SB7809TORX-T20
T25	1 SB7809TORX-T25
T27	1 SB7809TORX-T27
T30	1 SB7809TORX-T30
T40	1 SB7809TORX-T40
T45	1 SB7809TORX-T45
T50	1 SB7809TORX-T50
T55	1 SB7809TORX-T55
T60	1 SB7809TORX-T60

SB: Hängförpackade

1/2" bitshylsa för Torx®-skriv



7809TORX_L

T40	82 mm	5 7809TORX-T40-120
T45	80 mm	1 7809TORX-T45-120
T50	62 mm	1 7809TORX-T50-100
T55	102 mm	5 7809TORX-T55-140
T70	102 mm	5 7809TORX-T70-140

Sats med 1/2" bitshylsor med fyrkantfäste för Torx®-skriv



7809TO

9	1 7809TO

7809TORX-T27, 7809TORX-T20, 7809TORX-T25, 7809TORX-T30, 7809TORX-T50, 7809TORX-T40, 7809TORX-T45, 7809TORX-T60, 7809TORX-T55

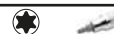

Sats med 1/2" bitshylsor med fyrkantfäste för Torx®-skriv. 9 delar



7800TORX/9

800 g	1 7800TORX/9

7800TORX-E8, 7800TORX-E10, 7800TORX-E11, 7800TORX-E12, 7800TORX-E14, 7800TORX-E16, 7800TORX-E18, 7800TORX-E20, 7800TORX-E24

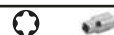

1/2" bitshylsor med fyrkantfäste för insexskriv



7809M

4 mm	10 7809M-4
5 mm	1 7809M-5
6 mm	1 7809M-6
7 mm	1 7809M-7
8 mm	1 7809M-8
9 mm	1 7809M-9
10 mm	1 7809M-10
12 mm	1 7809M-12
14 mm	1 7809M-14
17 mm	1 7809M-17
19 mm	1 7809M-19
4 mm	1 SB7809M-4
5 mm	1 SB7809M-5
6 mm	1 SB7809M-6
7 mm	1 SB7809M-7
8 mm	1 SB7809M-8
9 mm	1 SB7809M-9
10 mm	1 SB7809M-10
12 mm	1 SB7809M-12
14 mm	1 SB7809M-14
17 mm	1 SB7809M-17
19 mm	1 SB7809M-19

SB: Hängförpackade



1/2" bitshylsa för insexskruv



7809M L

Bit diameter	Length	Quantity	Part number
5 mm	61 mm	1	7809M-5-100
5 mm	143 mm	1	7809M-5-180
6 mm	59 mm	1	7809M-6-100
6 mm	103 mm	1	7809M-6-140
7 mm	63 mm	1	7809M-7-100
8 mm	83 mm	1	7809M-8-120
10 mm	103 mm	1	7809M-10-140
5 mm	63 mm	1	SB7809M-5-100
5 mm	140 mm	1	SB7809M-5-180
6 mm	62 mm	1	SB7809M-6-100
6 mm	103 mm	1	SB7809M-6-140
7 mm	63 mm	1	SB7809M-7-100
8 mm	81 mm	1	SB7809M-8-120
10 mm	101 mm	1	SB7809M-10-140



3/8 in	1	7809Z-3/8
7/16 in	1	7809Z-7/16
1/2 in	1	7809Z-1/2
17/32 in	1	7809Z-17/32
9/16 in	1	7809Z-9/16
19/32 in	1	7809Z-19/32
5/8 in	1	7809Z-5/8

1/2" bitshylsor med fyrkantfäste och tolv tandprofil



7809XZN



6	1	7809XZN-6
8	1	7809XZN-8
8	1	7809XZN-8-100
10	1	7809XZN-10
10	1	7809XZN-10-100
12	1	7809XZN-12
12	1	7809XZN-12-100
14	1	7809XZN-14
14	1	7809XZN-14-100
16	1	7809XZN-16
18	1	7809XZN-18

Sats med 1/2" bitshylsor med fyrkantfäste för insexskruv



7808HM

8	1	7808HM
---	---	--------

7809M-4, 7809M-6, 7809M-8, 7809M-7, 7809M-5, 7809M-10, 7809M-12, 7809M-14

1/2" bitshylsor med fyrkantfäste för insexskruv, tum-skala



7809Z

1/4 in	1	7809Z-3/16
5/16 in	1	7809Z-1/4
	1	7809Z-5/16

ERGO™ 1/2" spärrhandtag med 60 tänder och 6° omtagsvinkel



8155-1/2

262 mm	60	1	8155-1/2
--------	----	---	----------

1/2" spärrhandtag med smalt huvud, 72 tänder och 5° omtagsvinkel



8150SL

264 mm	72	1	8150SL
--------	----	---	--------

1/2" spärrhandtag med päronformat huvud, 80 tänder och 4,5° omtagsvinkel



8150-1/2

269 mm	80	1	8150-1/2
269 mm	80	1	SB8150-1/2

SB – levereras hängförpackad på blisterkort

1/2" spärrhandtag med runt huvud, 72 tänder och 5° omtagsvinkel



8150RN-1/2

267 mm	72	1	8150RN-1/2
267 mm	72	1	SB8150RN-1/2

SB – levereras hängförpackad på blisterkort

1/2" spärrhandtag med päronformat huvud, 60 tänder och 6° omtagsvinkel



SBS81



250 mm 60 5 SBS81

Sats med spärrhandtag för radiatorventiler - 3 delar i plastficka



8195-SET

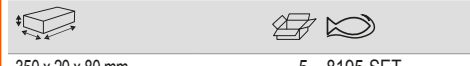

350 x 20 x 80 mm 5 8195-SET

Fyrkantstapp för 8195-R, 1/2" spärrhandtag



8195-SQ



37.5 mm 40 g 25 8195-SQ

1/2" spärrhandtag med vridbart huvud, 72 tänder och 5° omtagsvinkel



8120-1/2



266 mm 72 12 8120-1/2

8195-R

8195-SQ

8195-KEY

1/2" ledat spärrhandtag med 32 tänder och 11,25° omtagsvinkel



8110H-1/2

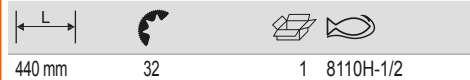

440 mm 32 1 8110H-1/2

Adapter för spärrhandtag med 52 tänder för 1/2" spärrhandtag



8151-1/2



71 mm 1 8151-1/2

1/2" spärrhandtag med 60 tänder och dubbla spärrfunktioner



8195-R



260 mm 60 1 8195-R

Fyrkantstapp för 8193-1/2 1/2" spärrhandtag



8194-1/2

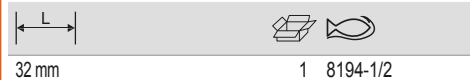

32 mm 1 8194-1/2

Reservdelssats till 8155-1/2, 1/2" spärrhandtag



8155-SO/1



6 8155-1/2 1 8155-SO/1



Reservdelssats till 8150SL 1/2" spärhandtag



8150SL-SPARE



12 8150SL 1 8150SL-SPARE

Reservdelssats till 8150-1/2 1/2" spärhandtag



8150-1/2-SPARE



11 8150-1/2 1 8150-1/2-SPARE

Reservdelssats till 8150RN-1/2 1/2" spärhandtag



8150RN-1/2-SPARE



6 8150RN-1/2 1 8150RN-1/2-SPARE

3/4"

3/4" sexkantshylsa med fyrkantfäste, metrisk dimensioner



8900SM



19 mm	1	8900SM-19
22 mm	1	8900SM-22
23 mm	1	8900SM-23
24 mm	5	8900SM-24
26 mm	5	8900SM-26
27 mm	5	8900SM-27
28 mm	1	8900SM-28
29 mm	1	8900SM-29
30 mm	5	8900SM-30
32 mm	5	8900SM-32
33 mm	1	8900SM-33
34 mm	1	8900SM-34
35 mm	1	8900SM-35
36 mm	5	8900SM-36
38 mm	1	8900SM-38
41 mm	5	8900SM-41
42 mm	1	8900SM-42
46 mm	1	8900SM-46
50 mm	1	8900SM-50
55 mm	1	8900SM-55
60 mm	1	8900SM-60

3/4" sexkantshylsa med fyrkantfäste, tum-dimensioner



8900SZ



3/4" in	1	8900SZ-3/4
13/16" in	1	8900SZ-13/16
7/8" in	1	8900SZ-7/8
1" in	1	8900SZ-1
1.1/16" in	1	8900SZ-1.1/16
1.5/16" in	1	8900SZ-1.5/16
1.3/8" in	1	8900SZ-1.3/8
1.7/16" in	1	8900SZ-1.7/16
1.9/16" in	1	8900SZ-1.9/16
1.5/8" in	1	8900SZ-1.5/8
1.3/4" in	1	8900SZ-1.3/4
1.13/16" in	1	8900SZ-1.13/16
1.7/8" in	1	8900SZ-1.7/8
2 in	1	8900SZ-2

3/4" tolvkantshylsor med fyrkantfäste, metrisk dimensioner



8900DM



19 mm	1	8900DM-19
21 mm	5	8900DM-21
22 mm	1	8900DM-22
23 mm	1	8900DM-23
24 mm	1	8900DM-24
25 mm	1	8900DM-25
26 mm	1	8900DM-26
27 mm	1	8900DM-27
28 mm	1	8900DM-28
29 mm	1	8900DM-29
30 mm	5	8900DM-30
32 mm	1	8900DM-32
33 mm	1	8900DM-33
34 mm	1	8900DM-34
35 mm	1	8900DM-35
36 mm	1	8900DM-36
37 mm	1	8900DM-37
38 mm	1	8900DM-38
40 mm	1	8900DM-40
41 mm	5	8900DM-41
42 mm	1	8900DM-42
46 mm	1	8900DM-46
47 mm	1	8900DM-47
50 mm	5	8900DM-50
52 mm	1	8900DM-52
40 mm	3	8900DM-54
55 mm	1	8900DM-55
56 mm	1	8900DM-56
60 mm	5	8900DM-60

3/4" tolvkantshylsa med fyrkantfäste, tum-dimensioner



8900DZ



3/4 in	1	8900DZ-3/4
13/16 in	1	8900DZ-13/16
7/8 in	1	8900DZ-7/8
15/16 in	1	8900DZ-15/16
31/32 in	1	8900DZ-31/32
1 in	1	8900DZ-1
1 1/16 in	1	8900DZ-1.1/16
1 1/8 in	1	8900DZ-1.1/8
1 3/16 in	1	8900DZ-1.3/16



1 1/4 in	1	8900DZ-1.1/4
1 5/16 in	5	8900DZ-1.5/16
1 3/8 in	1	8900DZ-1.3/8
1 7/16 in	1	8900DZ-1.7/16
1 1/2 in	1	8900DZ-1.1/2
1 9/16 in	1	8900DZ-1.9/16
1 5/8 in	1	8900DZ-1.5/8
1.11/16 in	1	8900DZ-1.11/16
1 3/4 in	1	8900DZ-1.3/4
1 13/16 in	1	8900DZ-1.13/16
1 7/8 in	1	8900DZ-1.7/8
2 in	1	8900DZ-2
2.1/16 in	1	8900DZ-2.1/16
2.1/8 in	1	8900DZ-2.1/8
2.3/16 in	1	8900DZ-2.3/16
2.1/4 in	1	8900DZ-2.1/4
2.3/8 in	5	8900DZ-2.3/8

T-stångshuvud med 3/4" fyrkantsfäste



8954A



62 mm



1 8954A

3/4" förlängare med fyrkantsfäste



8961/8962



200 mm

400 mm



1 8961

1 8962

3/4" universalhandtag med höglanspolerad yta



8953



505 mm



1 8953

3/4" ledhandtag med fyrkantsfäste



8958



570 mm



1 8958

Teleskophandtag med 3/4" fyrkantsfäste och matt yta



S93



510 mm



1 S93

3/4" ledhuvud med fyrkantsfäste, för ledhandtag 8958



8958A



125 mm



1 8958A

3/4" universalknut med fyrkantsfäste



8966



120 mm



1 8966

T-stångshandtag och t-stångshuvud med 3/4" fyrkantstapp



8954



505 mm



1 8954

3/4" vinkelhandtag med fyrkantsfäste



8963



415 mm



1 8963

Mellanstycke med fyrkantsfäste, hylsförminskning från 3/4" till 1/2"



8965



3/4



1/2



1 8965



Mellanstycke för föröring av 3/4" till 1" hylsa, med fyrkantsfäste



9564



3/4" 1" 1 9564

3/4" spärhandtag med päronformat huvud, 24 tänder och 15° omtagsvinkel



8955N



525 mm 24 1 8955N

3/4" runt spärhuvud med 72 tänder



8950N/A



170 mm 72 1 8950N/A

Tillbehör till 3/4" spärhandtag



8955N/A



152 mm 24 1 8955N/A

Universalhandtag 3/4"



8955N/B

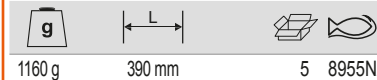

1160 g 390 mm 5 8955N/B

Spärhuvudsadapter med 72 tänder för 3/4" spärhandtag



8951



95.5 mm 1 8951

Reservdelssats till 8950 N och 8950N/A 3/4" spärhandtag



8950NA-SO/2



8 8950N, 8950N/A 1 8950NA-SO/2

Reservdelssats till 8955N och 8955N/A 3/4" spärhandtag



8955N-SPARE



11 8955N, 8955N/A 1 8955N-SPARE

1"

1" sexkantshylsor med fyrkantsfäste, i metriska dimensioner



9500SM



41 in	1	9500SM-41
46 in	1	9500SM-46
50 in	1	9500SM-50
54 in	1	9500SM-54
55 in	1	9500SM-55
58 in	1	9500SM-58

Ø	1	9500SM-60
60 in	1	9500SM-60
63 in	1	9500SM-63
65 in	1	9500SM-65
67 in	1	9500SM-67
70 in	1	9500SM-70
71 in	1	9500SM-71
75 in	1	9500SM-75
77 in	1	9500SM-77
80 in	1	9500SM-80
82 in	1	9500SM-82

1" sexkantshylsa med tolvkantprofil, tumdimensioner



9500DZ

Ø	1	9500DZ-1.5/8
1.5/8 in	1	9500DZ-1.5/8
1.13/16 in	1	9500DZ-1.13/16
1.7/8 in	1	9500DZ-1.7/8
2 in	1	9500DZ-2
2.1/8 in	1	9500DZ-2.1/8
2.3/16 in	1	9500DZ-2.3/16
2.1/4 in	1	9500DZ-2.1/4
2.3/8 in	1	9500DZ-2.3/8
2.1/2 in	1	9500DZ-2.1/2
2.9/16 in	1	9500DZ-2.9/16
2.5/8 in	1	9500DZ-2.5/8
2.3/4 in	1	9500DZ-2.3/4
2.15/16 in	1	9500DZ-2.15/16
3 in	1	9500DZ-3
3.1/8 in	1	9500DZ-3.1/8

Universalknut 1" med fyrkantfäste, ledhandtag, matt yta



9566A

L	1	9566A
167 mm	1	9566A

T-stångshandtag med 1" fyrkantfäste och matt yta



9555

L	1	9555
508 mm	1	9555

T-stånghuvud med 1" fyrkantfäste



9555AB

L	1	9555AB
78x78x78 mm	1	9555AB

1" förlängare med fyrkantfäste med matt yta



9560AB/9563AB

L	1	9560AB
200 mm	1	9560AB
440 mm	1	9563AB

Mellanstycke för förminskning från 1" till 3/4" med fyrkantfäste, matt yta



9565AB

Ø	Ø	1	9565AB
1"	3/4"	1	9565AB

Spärrhandtag 1" med runt huvud, 72 tänder och 5° omtagsvinkel



9550N

L	72	1	9550N
640 mm	72	1	9550N

Universalhandtag med 1" fyrkantfäste för spärrhuvuden



9550N/B

g	1	9550N/B
1960 g	1	9550N/B



1" runt spärrhuvud med 72 tänder



9550N/A

195 mm	72		1	9550N/A

Reservdelssats till 9550 N och 9550N/A 1" spärrhandtag



9550N-SPARE

2	9550N, 9550N/A	1	9550N-SPARE

70 x 160 x 280 mm	500 g	1	S330-CASE
110 x 320 x 375 mm	1620 g	1	S400-CASE
110 x 320 x 375 mm	1620 g	1	S410-CASE
100 x 215 x 375 mm	1120 g	1	S460-CASE
100 x 215 x 375 mm	1120 g	1	S560-CASE
110 x 375 x 430 mm	2200 g	1	S81MIX-CASE
110 x 375 x 430 mm	2200 g	1	S108-CASE
110 x 375 x 430 mm	2200 g	1	SLX17-CASE
100 x 215 x 375 mm	1120 g	1	S330L-CASE

Tomma askar för hylsnyckelsatser



SPARE-CASE

35 x 80 x 100 mm	1	SPAR-CASE-A7
35 x 85 x 160 mm	1	SPAR-CASE-A6
49 x 152 x 280 mm	1	SPAR-CASE-A4

TOMMA PLASTLÅDOR FÖR HYLSSNYCKELSATSER

Tomma lådor med avdelare för hylsnyckelsats



-CASE

110 x 375 x 430 mm	2200 g	1	S103-CASE
70 x 160 x 280 mm	520 g	1	S160-CASE
100 x 215 x 370 mm	1120 g	1	S240AF-CASE
70 x 160 x 280 mm	520 g	1	S290-CASE

STÄLLNINGSNYCKLAR

1/2" ställningsnycklar med fyrkantsfäste



SC2RM

13-17 mm	10	SC2RM-13-17
15-17 mm	10	SC2RM-15-17
19-22 mm	10	SC2RM-19-22
27-30 mm	1	SC2RM-27-30



Momentverktyg



DIGITALA MOMENTNYCKLAR

Digital tunn Bluetooth®-momentnyckel med moment och vinkel, minne och rektangulärt utbytbart huvud



TAWMB MICRO

mm	Nm	Nm		
9x12 mm	1.5-30 Nm	0,01 Nm	1	TAWMB930M
9x12 mm	6.8-135 Nm	0,1 Nm	1	TAWMB9135M

NOGGRANNHET: 20% till 100% av fullskala

Digital Bluetooth®-momentnyckel med moment och vinkel, minne och rektangulärt utbytbart huvud



TAWMB14_24

mm	Nm	Nm		
14x18 mm	17-340 Nm	1 Nm	1	TAWMB14340
24x32 mm	32.5-650 Nm	1 Nm	1	TAWMB24650
24x32 mm	40-800 Nm	1 Nm	1	TAWMB24800

NOGGRANNHET: 20% till 100% av fullskala

Elektronisk tunn moment- och vinkelnöckel med minne/USB och fast spårhuvud



TAWM MICRO

mm	Nm	Nm		
1/4 in	0.6-12 Nm	0,01 Nm	1	TAWM1412M
1/4 in	1.5-30 Nm	0,01 Nm	1	TAWM1430M
3/8 in	6.8-135 Nm	0,1 Nm	1	TAWM38135M

NOGGRANNHET: 20% till 100% av fullskala

Elektronisk tunn moment- och vinkelnöckel med minne/USB samt utbytbart rektangulärt huvud



TAWM9 MICRO

mm	Nm	Nm		
9x12 mm	0.6-12 Nm	0,01 Nm	1	TAWM912M
9x12 mm	1.5-30 Nm	0,01 Nm	1	TAWM930M
9x12 mm	6.8-135 Nm	0,1 Nm	1	TAWM9135M

NOGGRANNHET: 20% till 100% av fullskala

Elektronisk moment- och vinkelnöckel med minne/USB och fast spårhuvud. Med minne och USB-port för nedladdning av data



TAWM

	Nm	Nm		
3/8 in	7-135 Nm	1 Nm	1	TAWM38135
1/2 in	17-340 Nm	1 Nm	1	TAWM12340
3/4 in	40-800 Nm	1 Nm	1	TAWM34800

NOGGRANNHET: 20% till 100% av fullskala

Elektronisk moment- och vinkelnöckel med minne/USB samt utbytbart fyrkantshuvud. Med minne och USB



TAWM9_14_24

mm	Nm	Nm		
9x12 mm	7-135 Nm	1 Nm	1	TAWM9135
14x18 mm	17-340 Nm	1 Nm	1	TAWM14340
24x32 mm	40-800 Nm	1 Nm	1	TAWM24800

NOGGRANNHET: 20% till 100% av fullskala

Elektronisk tunn moment- och vinkelnöckel med fast spärrhuvud



TAW MICRO

	mm	Nm	Nm		
1/4 in	0.6-12 Nm	0,01 Nm		1	TAW1412M
1/4 in	1.5-30 Nm	0,01 Nm		1	TAW1430M
3/8 in	6.8-135 Nm	0,1 Nm		1	TAW38135M

NOGGRANNHET: 20% till 100% av fullskala

Elektronisk tunn moment- och vinkelnöckel med utbytbart fyrkantshuvud



TAW9 MICRO

mm	mm	Nm	Nm		
9x12 mm	0.6-12 Nm	0,01 Nm		1	TAW912M
9x12 mm	1.5-30 Nm	0,01 Nm		1	TAW930M
9x12 mm	6.8-135 Nm	0,1 Nm		1	TAW9135M

NOGGRANNHET: 20% till 100% av fullskala

Elektronisk moment- och vinkelnöckel med fast spärrhuvud



TAW

	mm	Nm	Nm		
3/8 in	7-135 Nm	1 Nm		1	TAW38135
1/2 in	17-340 Nm	1 Nm		1	TAW12340
3/4 in	40-800 Nm	1 Nm		1	TAW34800

NOGGRANNHET: 20% till 100% av fullskala

Elektronisk moment- och vinkelnöckel med utbytbart fyrkantshuvud



TAW9 14 24

	mm	Nm	Nm		
9x12 mm	7-135 Nm	1 Nm		1	TAW9135
14x18 mm	17-340 Nm	1 Nm		1	TAW14340
24x32 mm	40-800 Nm	1 Nm		1	TAW24800

NOGGRANNHET: 20% till 100% av fullskala

Elektronisk momentnöckel med utbytbart fyrkantshuvud



IZO-D

	mm	Nm	Nm		
1/4 in	3-30 Nm	0,1 Nm		1	IZO-D-30
3/8 in	13.5-135 Nm	1 Nm		1	IZO-D-135
1/2 in	20-200 Nm	1 Nm		1	IZO-D-200
1/2 in	34-340 Nm	1 Nm		1	IZO-D-340

Elektronisk momentnöckel med fast spärrhuvud. Momentverktyg med vinkelmätare



IZO-DR

	mm	Nm	Nm		
3/4 in	81-810 Nm	1 Nm		1	IZO-DR-810



MEKANISKA MOMENTNYCKLAR

Mekanisk justerbar momentklicknyckel med fönster och fast spärrhuvud

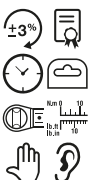

74WR-15/74WR-25

mm	Nm	Nm		
1/4 in	3-15 Nm	0,1 Nm	1	74WR-15
1/4 in	5-25 Nm	0,2 Nm	1	74WR-25

Mekanisk justerbar momentklicknyckel med fönsterskala och fast spärrhuvud med genomgående hål



74WR-50/74WR-400

mm	Nm	Nm		
3/8"	10-50 Nm	0,5 Nm	1	74WR-50
3/8"	20-100 Nm	1 Nm	1	74WR-100B
1/2"	20-100 Nm	1 Nm	1	74WR-100
1/2"	40-200 Nm	2 Nm	1	74WR-200
1/2"	60-300 Nm	2 Nm	1	74WR-300
1/2"	60-340 Nm	5 Nm	1	74WR-340
3/4"	80-400 Nm	5 Nm	1	74WR-400

Mekanisk justerbar momentklicknyckel med fönsterskala och utbytbart fyrkantshuvud



74W9/74W14

mm	Nm	Nm		
9x12 mm	3-15 Nm	0,2 Nm	1	74W9-15
9x12 mm	5-25 Nm	0,2 Nm	1	74W9-25
9x12 mm	10-50 Nm	0,5 Nm	1	74W9-50

mm	Nm	Nm		
9x12 mm	20-100 Nm	1 Nm	1	74W9-100
9x12 mm	40-200 Nm	1 Nm	1	74W9-200
14x18 mm	40-200 Nm	2 Nm	1	74W14-200
14x18 mm	60-300 Nm	2 Nm	1	74W14-300
14x18 mm	80-400 Nm	5 Nm	1	74W14-400

Mekanisk justerbar momentklicknyckel med fönsterskala och utbytbart huvud med runt tappfäste



74WS-15/74WS-300

mm	Nm	Nm		
16 mm	3-15 Nm	0,2 Nm	1	74WS-15
16 mm	5-25 Nm	0,2 Nm	1	74WS-25
16 mm	10-50 Nm	0,5 Nm	1	74WS-50
16 mm	20-100 Nm	1 Nm	1	74WS-100
16 mm	40-200 Nm	2 Nm	1	74WS-200
16 mm	60-300 Nm	2 Nm	1	74WS-300

Mekanisk justerbar momentklicknyckel med markerad skala och fast spärrhuvud

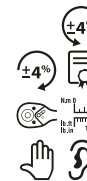

7455

mm	Nm	Nm		
1/4 in	1-5 Nm	0,05 Nm	1	7455-5
1/4 in	3-15 Nm	0,1 Nm	1	7455-15
1/4 in	4-20 Nm	0,1 Nm	1	7455-20
1/4 in	5-25 Nm	0,1 Nm	1	7455-25
3/8 in	12-60 Nm	0,5 Nm	1	7455-60
3/8 in	20-100 Nm	0,5 Nm	1	7455-100
1/2 in	20-100 Nm	0,5 Nm	1	7455-100A
1/2 in	40-200 Nm	2 Nm	1	7455-200
1/2 in	60-300 Nm	2 Nm	1	7455-300
1/2 in	68-340 Nm	2 Nm	1	7455-340
3/4 in	100-500 Nm	5 Nm	1	7455-500
3/4 in	160-800 Nm	5 Nm	1	7455-800
1 in	200-1000 Nm	10 Nm	1	7455-1000

Mekanisk justerbar momentklicknyckel med markerad skala, fast spärrhuvud och handtag med två sektioner

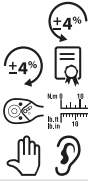

7455-1500

1 in	300-1500 Nm	10 Nm	1	7455-1500

Mekanisk justerbar momentklicknyckel med markerad skala, utbytbart huvud och handtag med två sektioner

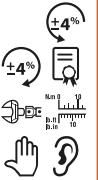

7465-1500

27x36 mm	300-1500 Nm	10 Nm	1	7465-1500

Mekanisk justerbar momentklicknyckel med markerad skala och fast huvud med fyrkantstapp



7455-2500

1 in	500-2500 Nm	10 Nm	1	7455-2500

Mekanisk justerbar momentklicknyckel med markerad skala och ledat spärrhuvud



7456

3/8 in	10-80 lb-ft lbf-ft	0,5 lb-ft lbf-ft	1	7456-80LB

Mekanisk justerbar momentklicknyckel med markerad skala och utbytbart huvud

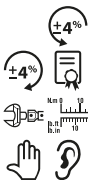

7465

9x12 mm	1-5 Nm	0,05 Nm	1	7465-5
9x12 mm	3-15 Nm	0,1 Nm	1	7465-15
9x12 mm	6-30 Nm	0,1 Nm	1	7465-30
9x12 mm	12-60 Nm	0,5 Nm	1	7465-60
9x12 mm	20-100 Nm	0,5 Nm	1	7465-100
14x18 mm	40-200 Nm	2 Nm	1	7465-200
14x18 mm	68-340 Nm	2 Nm	1	7465-340
24x32 mm	160-800 Nm	5 Nm	1	7465-800

Mekanisk justerbar momentklicknyckel med fast spärrhuvud och valfritt handgrepp



75R3/75R1

3/4" in	130-650 Nm	5 Nm	1	75R3-650
3/4" in	200-800 Nm	10 Nm	1	75R3-800
3/4" in	300-1000 Nm	10 Nm	1	75R3-1000
1" in	500-1500 Nm	10 Nm	1	75R1-1500



Mekanisk justerbar momentklicknyckel med valfritt handgrepp och utbytbart huvud med runt tappfäste



75S-650

22 mm	130-650 Nm	5 Nm	1	75S-650

Mekanisk momentnyckel break-back, med fast spärrhuvud och dubbeljustering



76R1-2000

1 in	900-2000 N·m	50 N·m	1	76R1-2000

Mekanisk justerbar "break-back" momentklicknyckel med fönster och fast spärrhuvud



76R3

3/4-1 in	120-600 Nm	10 Nm	1	76R3-600
3/4-1 in	200-800 Nm	10 Nm	1	76R3-800
3/4-1 in	300-1000 Nm	20 Nm	1	76R3-1000

Mekanisk justerbar, break-back momentklicknyckel med fönsterskala och utbytbart huvud med runt tappfäste



76S-600

22 mm	120-600 Nm	10 Nm	1	76S-600

Mekanisk momentnyckel break-back, med fast spärrhuvud



76R3-1500

3/4 in	700-1500 N·m	25 N·m	1	76R3-1500

Momentnyckel med klocka, fast fyrkantstapp och metallhandtag



7454 M

1/4 in	0.7-3.5 Nm	0,1 Nm	1	7454-3.5
1/4 in	1.68-8.4 Nm	0,2 Nm	1	7454-8.4
3/8 in	3.4-17 Nm	0,5 Nm	1	7454-17
3/8 in	6.4-32 Nm	0,5 Nm	1	7454-32
3/8 in	14-70 Nm	1 Nm	1	7454-70A
1/2 in	28-140 Nm	5 Nm	1	7454-140A
1/2 in	46-230 Nm	10 Nm	1	7454-230
3/4 in	96-480 Nm	10 Nm	1	7454-480A
	160-800 Nm	20 Nm	1	7454-800A

Mekanisk momentnyckel med klocka, fast fyrkantstapp och metallhandtag

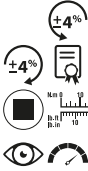

7454-480/7454-800

3/4 in	100-480 Nm	10 Nm	1	7454-480
3/4 in	160-800 Nm	20 Nm	1	7454-800

Mekanisk momentnyckel med klocka, fast fyrkantigt drivhuvud och handtag med två sektioner

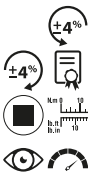

7454-1400

1 in	275-1400 Nm	25 Nm	1	7454-1400

Mekanisk momentnyckel med klocka/lysdiod och fast fyrkantstapp



7454-800E

3/4 in	160-800 Nm	20 Nm	1	7454-800E

Mekanisk momentnyckel med klocka/lysdiod och fast fyrkantstapp samt handtag med två sektioner



7454-1400E

1 in	275-1400 Nm	25 Nm	1	7454-1400E

Mekanisk förinställd momentklicknyckel med fast spärrhuvud



74PR-20

1/4 in	4-20 Nm	219 mm	1	74PR-20

Mekanisk förinställd momentklicknyckel med fast spärrhuvud med genomgående hål



74PR-60/74PR-400

3/8 in	12-60 Nm	295 mm	1	74PR-60
1/2 in	12-60 Nm	301 mm	1	74PR-60A
3/8 in	20-100 Nm	335 mm	1	74PR-100
1/2 in	20-100 Nm	342 mm	1	74PR-100A
1/2 in	40-200 Nm	425 mm	1	74PR-200
1/2 in	60-300 Nm	668 mm	1	74PR-300
3/4 in	80-400 Nm	675 mm	1	74PR-400



Mekanisk förinställd momentklicknyckel med utbytbar fyrkantshuvud och plasthandtag



74P9-20

mm	Nm	L	
9x12 mm	4-20 Nm	205 mm	1 74P9-20

Mekanisk förinställd momentklicknyckel med utbytbart huvud med runt tappfäste och gummihandtag



74PS-60/74PS-300

mm	Nm	L	
16 mm	12-60 Nm	283 mm	1 74PS-60
16 mm	20-100 Nm	324 mm	1 74PS-100
16 mm	40-200 Nm	405 mm	1 74PS-200
16 mm	60-300 Nm	643 mm	1 74PS-300

Mekanisk förinställd momentklicknyckel med utbytbar fyrkantshuvud och gummihandtag



74P9-60/74P14-400

mm	Nm	L	
9x12 mm	12-60 Nm	286 mm	1 74P9-60
9x12 mm	20-100 Nm	326 mm	1 74P9-100
14x18 mm	40-200 Nm	403 mm	1 74P14-200
14x18 mm	60-300 Nm	534 mm	1 74P14-300
14x18 mm	80-400 Nm	652 mm	1 74P14-400

Mekanisk förinställd momentklicknyckel med fast spärrhuvud och valfritt handgrepp



75P3/75P1

mm	Nm	L	
3/4 in	130-650 Nm	848 mm	1 75P3-650
3/4" in	200-800 Nm	1030 mm	1 75P3-800
3/4" in	300-1000 Nm	1238 mm	1 75P3-1000
1" in	500-1500 Nm	1563 mm	1 75P1-1500

Mekanisk förinställd momentklicknyckel med utbytbart huvud med runt tappfäste och plasthandtag



74PS-20

mm	Nm	L	
16 mm	4-20 Nm	206 mm	1 74PS-20

Mekanisk förinställd momentklicknyckel med valfritt handgrepp och utbytbart huvud med runt tappfäste



75PS-650

mm	Nm	L	
22 mm	130-650 Nm	800 mm	1 75PS-650

Handtagsförlängning för momentklicknyckel i 75-serien



75EXT

700 mm	60 mm	1.600 kg	1	75EXT

Justerbar momentskruvmejsel med fönsterskala



6973N-6978N

1/4 in	10-80 cNM	1 cNM	1	6973N
1/4 in	40-200 cNM	2 cNM	1	6976N
1/4 in	50-450 cNM	5 cNM	1	6978N

MOMENTSKRUVMEJSLAR

Elektronisk moment- och vinkelskruvmejsel



TAS14

1/4" in		0.04-0.7 Nm	1	TAS14H007
- in	1/4" in	0.04-0.7 Nm	1	TAS14S007
1/4" in		0.45-9 Nm	1	TAS14H09
	1/4" in	0.45-9 Nm	1	TAS14S09

NOGGRANNHET: 20% till 100% av fullskala

Digital momentskruvmejsel med moment och vinkel, med Bluetooth®



TASMB14H

1/4 in	0.04-0.7 Nm	0,01 Nm	1	TASMB14H007
1/4 in	0.45-9 Nm	0,01 Nm	1	TASMB14H09

NOGGRANNHET: 20% till 100% av fullskala

Justerbar minimomentnyckel med fast skruvmejselbit



6852-5

1/4 in	1-5 Nm	0.1 Nm	1	6852-5

Justerbar minimomentnyckelsats med fast skruvmejselbits



6852-5/S17

32 x 70 x 200 mm	0.29 kg	1	6852-5/S17

KM653-QR

6852-5		
6700SM-4		
59S/PH0, 59S/PH1		
59S/PZ0, 59S/PZ1		
59S/H1.5		
59S/0.8-5.5, 59S/0.6-4.5		
59S/T6, 59S/T7, 59S/T8		



Justerbar momentskruvmejsel med markerad skala i cNm



TSS120

1/4 in	10-120 cNm	1 cNm	1	TSS120

Justerbar momentskruvmejsel med markerad skala i Nm



TSS600

1/4 in	1-6 Nm	0,1 Nm	1	TSS600

Förinställd momentskruvmejsel med fönsterskala



6873N-6880N

7-70 cNm	1/4 in	1/4 in	1	6876N
15-170 cNm	1/4 in	1/4 in	1	6878N
45-450 cNm	1/4 in	1/4 in	1	6880N

Förinställd minimomentnyckel med fast skruvmejselbits



6852P-5

1/4" in	1-5 Nm	157 mm	1	6852P-5

Fast förinställd ERGO™-momentskruvmejsel. Med TORX® och TORX Plus®-klinga



BE-6990

0.6 Nm N-m	T6	IP6	1	BE-6990-IP6
0.9 Nm N-m	T7	IP7	1	BE-6990-IP7
1.2 Nm N-m	T8	IP8	1	BE-6990-IP8
1.4 Nm N-m	T9	IP9	1	BE-6990-IP9
2 Nm N-m	T10	IP10	1	BE-6990-IP10
3 Nm N-m	T15	IP15	1	BE-6990-IP15

Fast förinställd ERGO™-momentskruvmejselsats



BE-6990-IPSET

40 x 170 x 215 mm	0.755 kg	1	BE-6990-IPSET

BE-6990-IP7, BE-6990-IP8, BE-6990-IP9, BE-6990-IP15



Momentskruvmejselklinga med TORX®-spets



BE-6990TX-KL

T6		1.70 mm	160 mm	10	BE-6990TX-T6-KL
T7		1.99 mm	160 mm	10	BE-6990TX-T7-KL
T8		2.31 mm	160 mm	10	BE-6990TX-T8-KL
T9		2.50 mm	170 mm	10	BE-6990TX-T9-KL
T10		2.74 mm	170 mm	10	BE-6990TX-T10-KL
T15		3.27 mm	170 mm	10	BE-6990TX-T15-KL

Momentskruvmejselklingor med TORX PLUS®-spets



BE-6990-IP-KL

IP6		1.50 mm	170 mm	10	BE-6990-IP6-KL
IP7		1.99 mm	170 mm	10	BE-6990-IP7-KL
IP8		2.31 mm	170 mm	10	BE-6990-IP8-KL
IP9		2.50 mm	170 mm	10	BE-6990-IP9-KL
IP10		2.74 mm	170 mm	10	BE-6990-IP10-KL
IP15		3.27 mm	170 mm	10	BE-6990-IP15-KL

Reservklinga för skruv med TORX®-huvud Passar handtag BE-6990-AH



BE-6990-IP20-KL

IP20		4.5 mm	90 mm	20 g	10	BE-6990-IP20-KL

Reservklinga för skruvar med TORX®-huvud. Passar handtag BE-6990-AH



BE-6990TX-T20KL

T20		4.5 mm	92 mm	20 g	10	BE-6990TX-T20KL

MOMENTOMVANDLARE

Handhållen momentomvandlare med förskjutna och raka reaktionsarmar



89049TM-1000

1000 Nm-3/4 in	4.8:1/4.9:1*	208/204 Nm-1/2 in	1	89049TM-1000

Handhållen momentomvandlare med förskjutna och raka reaktionsarmar



8905-TM/9505-TM

1300 Nm-3/4 in	5:1	260 Nm-1/2 in	1	8905-TM
2700 Nm-1 in	5:1	540 Nm-3/4 in	1	9505-TM



Handhållen momentomvandlare med reaktionsplatta



9505/9605/9525/9625

in		in	
3400 Nm-1 in	5:1	680 Nm-3/4 in	1 9505-3400
3400 Nm-1 in	25:1	136 Nm-1/2 in	1 9525-3400
9500 Nm-1.1/2 in	25:1	380 Nm-3/4 in	1 9625-9500

Handhållen momentomvandlare med rak reaktionsarm



95155B/9526B

in		in	
3000 Nm-1 in	15.5:1	193 Nm-1/2 in	1 95155B-3000
4500 Nm-1 in	26:1	173 Nm-1/2 in	1 9526B-4500

Kompakt handhållen momentomvandlare med förskjuten reaktionsarm



89222CR/96255CR

in		in	
1000 Nm-3/4 in	22.2:1	45 Nm-1/2 in	1 89222CR-1000
2000 Nm-1 in	27:1	74 Nm-1/2 in	1 9527CR-2000
4000 Nm-1 in	25:1	160 Nm-1/2 in	1 9525CR-4000
7000 Nm-1.1/2 in	25.5:1	274 Nm-1/2 in	1 96255CR-7000

MOMENTPROVARE

Multifunktionell momentprovare för skruvmejslar och momentnycklar



TEA003-TEA030

Nm		Nm	
0.1-3.0 Nm N-m	1/4 in	0,01 Nm	1 TEA003
0.5-10 Nm N-m	1/4 in	0,01 Nm	1 TEA010
1.5-30 Nm N-m	10 mm	0,1 Nm	1 TEA030



Momentreferensadapter för momenttestutrustning



TJS

måx			
3 N-m	1/4 in	31 mm	1 TJS003
10 N-m	1/4 in	31 mm	1 TJS010
30 N-m	1/4 in	31 mm	1 TJS030

Multifunktionell momentprovare för momentnycklar



TEA065-TEA2100

Nm		in	
3-65 Nm N-m	- mm	3/8 in	1 TEA065
10-350 Nm N-m	- mm	1/2 in	1 TEA350
50-1100 Nm N-m	27 mm	3/4 in	1 TEA1100
200-2100 Nm N-m	27 mm		1 TEA2100



MOMENTVINKELADAPTRAR

Elektronisk moment- och vinkelmätare



TAM

Drive	Range (Nm)	Length (mm)	Part No.
1/4 in	1,5-30	56	TAM1430
3/8 in	6,8-135	56	TAM38135
1/2 in	6,8-135	56	TAM12135
1/2 in	10-200	56	TAM12200
1/2 in	17-340	56	TAM12340

Elektronisk vinkelmätare



MAM

Range (°)	Length (mm)	Part No.
0-360°	56	1 MAM50M

Vinkelmätare med magnet



7851-M/8951-M

Drive	Range (°)	Length (mm)	Part No.
1/2 in	0-360	490	1 7851-M
3/4 in	0-360	490	1 8951-M

Vinkelmätare med klämma



7851-G

Drive	Range (°)	Length (mm)	Part No.
1/2 in	0-360	555	1 7851-G

INSTICKSVERKTYG

Spärrhuvud av rund typ med rektangulärt fäste



9/14/24/27R

Drive	Length (mm)	Max Torque (Nm)	Part No.
1/4 in	9x12	30	1 9R-1/4
3/8 in	9x12	135	1 9R-3/8
1/2 in	9x12	160	1 9R-1/2
1/2 in	14x18	340	1 14R-1/2
3/4 in	14x18	420	1 14R-3/4
3/4 in	24x32	1000	1 24R-3/4
1 in	24x32	1200	1 24R-1
1 in	27x36	2500	1 27R-1

Spärrhuvud med genomgående fyrkantshål och fyrkantfäste



9/14/24/27T





Drive	Length (mm)	Max Torque (Nm)	Part No.
1/4 in	9x12	30	1 9T-1/4
3/8 in	9x12	135	1 9T-3/8
1/2 in	9x12	160	1 9T-1/2
1/2 in	14x18	340	1 14T-1/2
3/4 in	14x18	420	1 14T-3/4
3/4 in	24x32	1000	1 24T-3/4
1 in	24x32	1200	1 24T-1
1 in	27x36	2500	1 27T-1



Fast fyrkantigt huvud med fyrkantfäste







9/14/24/27F

					
		mm			
1/4 in		9x12 mm	30 Nm	1	9F-1/4
3/8 in		9x12 mm	135 Nm	1	9F-3/8
1/2 in		9x12 mm	160 Nm	1	9F-1/2
1/2 in		14x18 mm	340 Nm	1	14F-1/2
3/4 in		14x18 mm	420 Nm	1	14F-3/4
3/4 in		24x32 mm	1000 Nm	1	24F-3/4
1 in		24x32 mm	1200 Nm	1	24F-1
1 in		27x36 mm	2500 Nm	1	27F-1

Spärrhuvud av päronformad typ med fyrkantfäste







9/14P

					
		mm			
1/4 in		9x12 mm	30 Nm	1	9P-1/4
3/8 in		9x12 mm	135 Nm	1	9P-3/8
1/2 in		9x12 mm	160 Nm	1	9P-1/2
1/2 in		14x18 mm	340 Nm	1	14P-1/2

Spärrhuvud av päronformad typ med snabbfäste och fyrkantfäste



9/14Q

					
		mm			
1/4 in		9x12 mm	30 Nm	1	9Q-1/4
3/8 in		9x12 mm	135 Nm	1	9Q-3/8
1/2 in		9x12 mm	160 Nm	1	9Q-1/2
1/2 in		14x18 mm	340 Nm	1	14Q-1/2

Spärrhuvud för skruvmejselbits med fyrkantfäste







9B





			
	mm		
1/4 in	9x12 mm	1	9B-1/4
5/16 in	9x12 mm	1	9B-5/16

Metrisk u-nyckel med fyrkantfäste



9/14/24/27T





				
	mm			
7 mm	9x12 mm	9 Nm	1	9T-7
8 mm	9x12 mm	13 Nm	1	9T-8
9 mm	9x12 mm	18 Nm	1	9T-9
10 mm	9x12 mm	24 Nm	1	9T-10
11 mm	9x12 mm	32 Nm	1	9T-11
12 mm	9x12 mm	41 Nm	1	9T-12
13 mm	9x12 mm	51 Nm	1	9T-13
14 mm	9x12 mm	63 Nm	1	9T-14
15 mm	9x12 mm	77 Nm	1	9T-15
16 mm	9x12 mm	92 Nm	1	9T-16
17 mm	9x12 mm	109 Nm	1	9T-17
18 mm	9x12 mm	125 Nm	1	9T-18
19 mm	9x12 mm	145 Nm	1	9T-19
21 mm	9x12 mm	160 Nm	1	9T-21
22 mm	9x12 mm	160 Nm	1	9T-22
24 mm	9x12 mm	160 Nm	1	9T-24
27 mm	9x12 mm	160 Nm	1	9T-27
30 mm	9x12 mm	160 Nm	1	9T-30
32 mm	9x12 mm	160 Nm	1	9T-32
13 mm	14x18 mm	51 Nm	1	14T-13
14 mm	14x18 mm	63 Nm	1	14T-14
15 mm	14x18 mm	77 Nm	1	14T-15
16 mm	14x18 mm	92 Nm	1	14T-16
17 mm	14x18 mm	109 Nm	1	14T-17
18 mm	14x18 mm	125 Nm	1	14T-18
19 mm	14x18 mm	145 Nm	1	14T-19
21 mm	14x18 mm	190 Nm	1	14T-21
22 mm	14x18 mm	220 Nm	1	14T-22
24 mm	14x18 mm	280 Nm	1	14T-24
25 mm	14x18 mm	320 Nm	1	14T-25
27 mm	14x18 mm	360 Nm	1	14T-27
30 mm	14x18 mm	360 Nm	1	14T-30
32 mm	14x18 mm	360 Nm	1	14T-32
33 mm	14x18 mm	360 Nm	1	14T-33
34 mm	14x18 mm	360 Nm	1	14T-34
35 mm	14x18 mm	360 Nm	1	14T-35
36 mm	14x18 mm	360 Nm	1	14T-36
37 mm	14x18 mm	360 Nm	1	14T-37
38 mm	14x18 mm	360 Nm	1	14T-38
39 mm	14x18 mm	360 Nm	1	14T-39
41 mm	14x18 mm	360 Nm	1	14T-41
45 mm	14x18 mm	360 Nm	1	14T-45

				
mm	mm	Nm		
46 mm	14x18 mm	360 Nm	1	147-46
50 mm	14x18 mm	360 Nm	1	147-50
55 mm	14x18 mm	360 Nm	1	147-55
60 mm	14x18 mm	360 Nm	1	147-60
68 mm	14x18 mm	360 Nm	1	147-68
70 mm	14x18 mm	360 Nm	1	147-70
75 mm	14x18 mm	360 Nm	1	147-75
90 mm	14x18 mm	360 Nm	1	147-90
24 mm	24x32 mm	1200 Nm	1	247-24
27 mm	24x32 mm	1200 Nm	1	247-27
30 mm	24x32 mm	1200 Nm	1	247-30
32 mm	24x32 mm	1200 Nm	1	247-32
34 mm	24x32 mm	1200 Nm	1	247-34
36 mm	24x32 mm	1200 Nm	1	247-36
41 mm	24x32 mm	1200 Nm	1	247-41
46 mm	24x32 mm	1200 Nm	1	247-46
50 mm	24x32 mm	1200 Nm	1	247-50
55 mm	24x32 mm	1200 Nm	1	247-55
60 mm	24x32 mm	1200 Nm	1	247-60
30 mm	27x36 mm	3000 Nm	1	277-30
32 mm	27x36 mm	3000 Nm	1	277-32
34 mm	27x36 mm	3000 Nm	1	277-34
36 mm	27x36 mm	3000 Nm	1	277-36
41 mm	27x36 mm	3000 Nm	1	277-41
46 mm	27x36 mm	3000 Nm	1	277-46
50 mm	27x36 mm	3000 Nm	1	277-50
55 mm	27x36 mm	3000 Nm	1	277-55
60 mm	27x36 mm	3000 Nm	1	277-60

U-nyckel i tum-storlekar med fyrkantfäste







9/14/24/277"

				
in	mm	Nm		
1/4 in	9x12 mm	6 Nm	1	97-1/4
5/16 in	9x12 mm	13 Nm	1	97-5/16
3/8 in	9x12 mm	24 Nm	1	97-3/8
7/16 in	9x12 mm	32 Nm	1	97-7/16
1/2 in	9x12 mm	51 Nm	1	97-1/2
17/32 in	9x12 mm	63 Nm	1	97-17/32
9/16 in	9x12 mm	77 Nm	1	97-9/16
5/8 in	9x12 mm	92 Nm	1	97-5/8
11/16 in	9x12 mm	125 Nm	1	97-11/16
3/4 in	9x12 mm	145 Nm	1	97-3/4
13/16 in	9x12 mm	160 Nm	1	97-13/16
7/8 in	9x12 mm	160 Nm	1	97-7/8
15/16 in	9x12 mm	160 Nm	1	97-15/16
1 in	9x12 mm	160 Nm	1	97-1
7/16 in	14x18 mm	32 Nm	1	147-7/16
1/2 in	14x18 mm	51 Nm	1	147-1/2
9/16 in	14x18 mm	77 Nm	1	147-9/16
5/8 in	14x18 mm	92 Nm	1	147-5/8
11/16 in	14x18 mm	109 Nm	1	147-11/16
3/4 in	14x18 mm	145 Nm	1	147-3/4
13/16 in	14x18 mm	190 Nm	1	147-13/16
7/8 in	14x18 mm	220 Nm	1	147-7/8
15/16 in	14x18 mm	280 Nm	1	147-15/16
1 in	14x18 mm	360 Nm	1	147-1
1 1/8 in	14x18 mm	360 Nm	1	147-1.1/8
1 1/4 in	14x18 mm	360 Nm	1	147-1.1/4

Metrisk ringnyckel med fyrkantfäste



9/14/24/278

				
mm	mm	Nm		
7 mm	9x12 mm	25 Nm	1	98-7
8 mm	9x12 mm	34 Nm	1	98-8
9 mm	9x12 mm	45 Nm	1	98-9
10 mm	9x12 mm	58 Nm	1	98-10
11 mm	9x12 mm	47 Nm	1	98-11
12 mm	9x12 mm	89 Nm	1	98-12
13 mm	9x12 mm	105 Nm	1	98-13
14 mm	9x12 mm	125 Nm	1	98-14
15 mm	9x12 mm	145 Nm	1	98-15
16 mm	9x12 mm	160 Nm	1	98-16
17 mm	9x12 mm	160 Nm	1	98-17
18 mm	9x12 mm	160 Nm	1	98-18
19 mm	9x12 mm	160 Nm	1	98-19
21 mm	9x12 mm	160 Nm	1	98-21
22 mm	9x12 mm	160 Nm	1	98-22
13 mm	14x18 mm	105 Nm	1	148-13
14 mm	14x18 mm	125 Nm	1	148-14
15 mm	14x18 mm	150 Nm	1	148-15
16 mm	14x18 mm	175 Nm	1	148-16
17 mm	14x18 mm	200 Nm	1	148-17
18 mm	14x18 mm	230 Nm	1	148-18
19 mm	14x18 mm	260 Nm	1	148-19
21 mm	14x18 mm	330 Nm	1	148-21
22 mm	14x18 mm	360 Nm	1	148-22
24 mm	14x18 mm	360 Nm	1	148-24
27 mm	14x18 mm	360 Nm	1	148-27
28 mm	14x18 mm	360 Nm	1	148-28
30 mm	14x18 mm	360 Nm	1	148-30
32 mm	14x18 mm	360 Nm	1	148-32
34 mm	14x18 mm	360 Nm	1	148-34
36 mm	14x18 mm	360 Nm	1	148-36
41 mm	14x18 mm	360 Nm	1	148-41
24 mm	24x32 mm	1200 Nm	1	248-24
27 mm	24x32 mm	1200 Nm	1	248-27
30 mm	24x32 mm	1200 Nm	1	248-30
32 mm	24x32 mm	1200 Nm	1	248-32
34 mm	24x32 mm	1200 Nm	1	248-34
36 mm	24x32 mm	1200 Nm	1	248-36
41 mm	24x32 mm	1200 Nm	1	248-41
46 mm	24x32 mm	1200 Nm	1	248-46
50 mm	24x32 mm	1200 Nm	1	248-50
55 mm	24x32 mm	1200 Nm	1	248-55
60 mm	24x32 mm	1200 Nm	1	248-60
30 mm	27x36 mm	3000 Nm	1	278-30
32 mm	27x36 mm	1240 Nm	1	278-32
34 mm	27x36 mm	3000 Nm	1	278-34
36 mm	27x36 mm	3000 Nm	1	278-36
41 mm	27x36 mm	3000 Nm	1	278-41
46 mm	27x36 mm	3000 Nm	1	278-46
50 mm	27x36 mm	3000 Nm	1	278-50
55 mm	27x36 mm	3000 Nm	1	278-55
60 mm	27x36 mm	3000 Nm	1	278-60



Ringnyckel i tum-storlekar med fyrkantsfäste



9/14/24/278"

1/4 in	9x12 mm	25 Nm	1	98-1/4
5/16 in	9x12 mm	34 Nm	1	98-5/16
3/8 in	9x12 mm	58 Nm	1	98-3/8
7/16 in	9x12 mm	72 Nm	1	98-7/16
1/2 in	9x12 mm	105 Nm	1	98-1/2
9/16 in	9x12 mm	125 Nm	1	98-9/16
5/8 in	9x12 mm	160 Nm	1	98-5/8
11/16 in	9x12 mm	160 Nm	1	98-11/16
3/4 in	9x12 mm	57 Nm	1	98-3/4
13/16 in	14x18 mm	330 Nm	1	148-13/16
13/16 in	9x12 mm	160 Nm	1	98-13/16
7/8 in	9x12 mm	160 Nm	1	98-7/8
1/2 in	14x18 mm	105 Nm	1	148-1/2
9/16 in	14x18 mm	150 Nm	1	148-9/16
5/8 in	14x18 mm	175 Nm	1	148-5/8
11/16 in	14x18 mm	230 Nm	1	148-11/16
3/4 in	14x18 mm	260 Nm	1	148-3/4
15/16 in	14x18 mm	360 Nm	1	148-15/16
7/8 in	14x18 mm	360 Nm	1	148-7/8
1 in	14x18 mm	360 Nm	1	148-1

Öppen ringnyckel med fyrkantsfäste



99 in

3/8 in	9x12 mm	9 Nm	1	99-3/8
7/16 in	9x12 mm	16 Nm	1	99-7/16
1/2 in	9x12 mm	28 Nm	1	99-1/2
9/16 in	9x12 mm	31 Nm	1	99-9/16
5/8 in	9x12 mm	46 Nm	1	99-5/8
11/16 in	9x12 mm	65 Nm	1	99-11/16
3/4 in	9x12 mm	74 Nm	1	99-3/4

Öppen ringnyckel med fyrkantsfäste



99

10 mm	9x12 mm	14 Nm	1	99-10
11 mm	9x12 mm	19 Nm	1	99-11
12 mm	9x12 mm	24 Nm	1	99-12
13 mm	9x12 mm	30 Nm	1	99-13
14 mm	9x12 mm	37 Nm	1	99-14
16 mm	9x12 mm	46 Nm	1	99-16
17 mm	9x12 mm	55 Nm	1	99-17
18 mm	9x12 mm	65 Nm	1	99-18
19 mm	9x12 mm	74 Nm	1	99-19
21 mm	9x12 mm	87 Nm	1	99-21
22 mm	9x12 mm	96 Nm	1	99-22
24 mm	9x12 mm	96 Nm	1	99-24

Rektangulära anslutningsadapter för ökning och minskning



9/14/24/27A

9x12 mm	14x18 mm	160 Nm	1	9A-14
14x18 mm	9x12 mm	160 Nm	1	14A-9
14x18 mm	24x32 mm	360 Nm	1	14A-32
24x32 mm	14x18 mm	360 Nm	1	24A-14
24x32 mm	27x36 mm	1200 Nm	1	24A-27
27x36 mm	24x32 mm	1200 Nm	1	27A-24

Svetsadapter med fyrkantsfäste







9/14/24W

9x12 mm	23 mm	1	9W
14x18 mm	39 mm	1	14W
24x32 mm	65 mm	1	24W

Spärrhuvud av rund typ för runt tappfäste







16R/22R

				
	mm			
1/4" in	16 mm	20 Nm	1	16R-1/4
3/8" in	16 mm	160 Nm	1	16R-3/8
1/2" in	16 mm	420 Nm	1	16R-1/2
3/4" in	22 mm	1200 Nm	1	22R-3/4

Huvud med fast fyrkantstapp, för runt tappfäste







16F/22F





				
	mm			
1/4" in	16 mm	20 Nm	1	16F-1/4
3/8" in	16 mm	160 Nm	1	16F-3/8
1/2" in	16 mm	420 Nm	1	16F-1/2
3/4" in	22 mm	1200 Nm	1	22F-3/4

Metrisk u-nyckel, för runt tappfäste



167/227





				
	mm			
7 mm	16 mm	9 Nm	1	167-7
8 mm	16 mm	13 Nm	1	167-8
9 mm	16 mm	18 Nm	1	167-9
10 mm	16 mm	24 Nm	1	167-10
11 mm	16 mm	32 Nm	1	167-11
12 mm	16 mm	41 Nm	1	167-12

				
	mm			
13 mm	16 mm	51 Nm	1	167-13
14 mm	16 mm	63 Nm	1	167-14
15 mm	16 mm	77 Nm	1	167-15
16 mm	16 mm	92 Nm	1	167-16
17 mm	16 mm	109 Nm	1	167-17
18 mm	16 mm	125 Nm	1	167-18
19 mm	16 mm	145 Nm	1	167-19
20 mm	16 mm	160 Nm	1	167-20
21 mm	16 mm	190 Nm	1	167-21
22 mm	16 mm	220 Nm	1	167-22
23 mm	16 mm	250 Nm	1	167-23
24 mm	16 mm	280 Nm	1	167-24
25 mm	16 mm	320 Nm	1	167-25
26 mm	16 mm	360 Nm	1	167-26
27 mm	16 mm	360 Nm	1	167-27
28 mm	16 mm	360 Nm	1	167-28
30 mm	16 mm	360 Nm	1	167-30
32 mm	16 mm	360 Nm	1	167-32
36 mm	16 mm	360 Nm	1	167-36
22 mm	22 mm	1200 Nm	1	227-22
24 mm	22 mm	1200 Nm	1	227-24
27 mm	22 mm	1200 Nm	1	227-27
30 mm	22 mm	1200 Nm	1	227-30
32 mm	22 mm	1200 Nm	1	227-32
34 mm	22 mm	1200 Nm	1	227-34
36 mm	22 mm	1200 Nm	1	227-36
41 mm	22 mm	1200 Nm	1	227-41
46 mm	22 mm	1200 Nm	1	227-46

Öppen nyckel i tum, för runt tappfäste



167





				
	mm			
5/16 in	16 mm	34 Nm	1	167-5/16
3/8 in	16 mm	45 Nm	1	167-3/8
7/16 in	16 mm	72 Nm	1	167-7/16
1/2 in	16 mm	51 Nm	1	167-1/2
9/16 in	16 mm	77 Nm	1	167-9/16
5/8 in	16 mm	92 Nm	1	167-5/8
11/16 in	16 mm	109 Nm	1	167-11/16
3/4 in	16 mm	145 Nm	1	167-3/4
13/16 in	16 mm	190 Nm	1	167-13/16
7/8 in	16 mm	220 Nm	1	167-7/8
15/16 in	16 mm	280 Nm	1	167-15/16
1 in	16 mm	360 Nm	1	167-1
1.1/16 in	16 mm	360 Nm	1	167-1.1/16
1.1/8 in	16 mm	360 Nm	1	167-1.1/8
1.3/16 in	16 mm	360 Nm	1	167-1.3/16
1.1/4 in	16 mm	360 Nm	1	167-1.1/4



Metrisk ringnyckel, för runt tappfäste







168/228





				
mm	mm	Nm		
7 mm	16 mm	25 Nm	1	168-7
8 mm	16 mm	34 Nm	1	168-8
9 mm	16 mm	45 Nm	1	168-9
10 mm	16 mm	58 Nm	1	168-10
11 mm	16 mm	72 Nm	1	168-11
12 mm	16 mm	89 Nm	1	168-12
13 mm	16 mm	105 Nm	1	168-13
14 mm	16 mm	125 Nm	1	168-14
15 mm	16 mm	150 Nm	1	168-15
16 mm	16 mm	175 Nm	1	168-16
17 mm	16 mm	200 Nm	1	168-17
18 mm	16 mm	230 Nm	1	168-18
19 mm	16 mm	260 Nm	1	168-19
20 mm	16 mm	290 Nm	1	168-20
21 mm	16 mm	330 Nm	1	168-21
22 mm	16 mm	360 Nm	1	168-22
23 mm	16 mm	360 Nm	1	168-23
24 mm	16 mm	360 Nm	1	168-24
26 mm	16 mm	360 Nm	1	168-26
27 mm	16 mm	360 Nm	1	168-27
22 mm	22 mm	1200 Nm	1	228-22
24 mm	22 mm	1200 Nm	1	228-24
27 mm	22 mm	1200 Nm	1	228-27
30 mm	22 mm	1200 Nm	1	228-30
32 mm	22 mm	1200 Nm	1	228-32
34 mm	22 mm	1200 Nm	1	228-34
36 mm	22 mm	1200 Nm	1	228-36
41 mm	22 mm	1200 Nm	1	228-41
46 mm	22 mm	1200 Nm	1	228-46

Ringnyckel i tum-storlekar, för runt tappfäste



168





				
in	mm	Nm		
5/16 in	16 mm	34 Nm	1	168-5/16
3/8 in	16 mm	58 Nm	1	168-3/8
7/16 in	16 mm	89 Nm	1	168-7/16
1/2 in	16 mm	105 Nm	1	168-1/2

				
in	mm	Nm		
9/16 in	16 mm	125 Nm	1	168-9/16
5/8 in	16 mm	125 Nm	1	168-5/8
11/16 in	16 mm	125 Nm	1	168-11/16
3/4 in	16 mm	260 Nm	1	168-3/4
13/16 in	16 mm	290 Nm	1	168-13/16
7/8 in	16 mm	360 Nm	1	168-7/8
15/16 in	16 mm	360 Nm	1	168-15/16
1 in	16 mm	360 Nm	1	168-1
1.1/16 in	16 mm	360 Nm	1	168-1.1/16
1.3/16 in	16 mm	360 Nm	1	168-1.3/16

Metrisk öppen ringnyckel, för runt tappfäste



169

				
mm	mm	Nm		
7 mm	16 mm	6 Nm	1	169-7
8 mm	16 mm	8 Nm	1	169-8
9 mm	16 mm	10 Nm	1	169-9
10 mm	16 mm	12 Nm	1	169-10
11 mm	16 mm	16 Nm	1	169-11
12 mm	16 mm	16 Nm	1	169-12
13 mm	16 mm	28 Nm	1	169-13
14 mm	16 mm	31 Nm	1	169-14
15 mm	16 mm	38 Nm	1	169-15
16 mm	16 mm	46 Nm	1	169-16
17 mm	16 mm	53 Nm	1	169-17
18 mm	16 mm	65 Nm	1	169-18
19 mm	16 mm	74 Nm	1	169-19
20 mm	16 mm	86 Nm	1	169-20
21 mm	16 mm	100 Nm	1	169-21
22 mm	16 mm	115 Nm	1	169-22
23 mm	16 mm	125 Nm	1	169-23
24 mm	16 mm	145 Nm	1	169-24
27 mm	16 mm	160 Nm	1	169-27



Maskindrivna verktygstillbehör



HÅLSÅGAR

Sandflex® bimetallhålsågar för metall/
träskivor på 14 till 210 mm



3830

14 mm	1	3830-14-C
16 mm	1	3830-16-C
17 mm	1	3830-17-C
19 mm	1	3830-19-C
20 mm	1	3830-20-C
21 mm	1	3830-21-C
22 mm	1	3830-22-C
24 mm	1	3830-24-C
25 mm	1	3830-25-C
27 mm	1	3830-27-C
29 mm	1	3830-29-C
30 mm	1	3830-30-C
32 mm	1	3830-32-C
33 mm	1	3830-33-C
35 mm	1	3830-35-C
37 mm	1	3830-37-C
38 mm	1	3830-38-C
40 mm	1	3830-40-C
41 mm	1	3830-41-C
43 mm	1	3830-43-C
44 mm	1	3830-44-C
46 mm	1	3830-46-C
48 mm	1	3830-48-C
50 mm	1	3830-50-C
51 mm	1	3830-51-C
52 mm	1	3830-52-C
54 mm	1	3830-54-C
55 mm	1	3830-55-C
56 mm	1	3830-56-C
57 mm	1	3830-57-C
59 mm	1	3830-59-C
60 mm	1	3830-60-C
64 mm	1	3830-64-C
65 mm	1	3830-65-C
67 mm	1	3830-67-C
68 mm	1	3830-68-C
70 mm	1	3830-70-C
73 mm	1	3830-73-C
76 mm	1	3830-76-C
79 mm	1	3830-79-C
83 mm	1	3830-83-C
86 mm	1	3830-86-C
89 mm	1	3830-89-C
92 mm	1	3830-92-C
95 mm	1	3830-95-C
98 mm	1	3830-98-C
102 mm	1	3830-102-C
105 mm	1	3830-105-C
108 mm	1	3830-108-C

111 mm	1	3830-111-C
114 mm	1	3830-114-C
121 mm	1	3830-121-C
127 mm	1	3830-127-C
133 mm	1	3830-133-C
140 mm	1	3830-140-C
146 mm	1	3830-146-C
152 mm	1	3830-152-C
14 mm	6	3830-14-VIP
16 mm	6	3830-16-VIP
17 mm	6	3830-17-VIP
19 mm	6	3830-19-VIP
20 mm	6	3830-20-VIP
21 mm	6	3830-21-VIP
22 mm	6	3830-22-VIP
24 mm	6	3830-24-VIP
25 mm	6	3830-25-VIP
27 mm	6	3830-27-VIP
29 mm	6	3830-29-VIP
30 mm	6	3830-30-VIP
32 mm	6	3830-32-VIP
33 mm	6	3830-33-VIP
35 mm	6	3830-35-VIP
37 mm	6	3830-37-VIP
38 mm	6	3830-38-VIP
40 mm	6	3830-40-VIP
41 mm	6	3830-41-VIP
43 mm	6	3830-43-VIP
44 mm	6	3830-44-VIP
46 mm	6	3830-46-VIP
48 mm	6	3830-48-VIP
50 mm	6	3830-50-VIP
51 mm	6	3830-51-VIP
52 mm	4	3830-52-VIP
54 mm	4	3830-54-VIP
55 mm	4	3830-55-VIP
56 mm	4	3830-56-VIP
57 mm	4	3830-57-VIP
59 mm	4	3830-59-VIP
60 mm	4	3830-60-VIP
62 mm	4	3830-62-VIP
64 mm	4	3830-64-VIP
65 mm	4	3830-65-VIP
67 mm	4	3830-67-VIP
68 mm	4	3830-68-VIP
70 mm	4	3830-70-VIP
73 mm	4	3830-73-VIP
76 mm	4	3830-76-VIP
79 mm	4	3830-79-VIP
83 mm	4	3830-83-VIP
86 mm	4	3830-86-VIP
89 mm	4	3830-89-VIP
92 mm	4	3830-92-VIP
95 mm	4	3830-95-VIP
98 mm	4	3830-98-VIP
102 mm	4	3830-102-VIP
105 mm	4	3830-105-VIP
108 mm	4	3830-108-VIP
111 mm	4	3830-111-VIP
114 mm	4	3830-114-VIP
121 mm	1	3830-121-VIP
127 mm	1	3830-127-VIP
133 mm	1	3830-133-VIP
140 mm	1	3830-140-VIP
146 mm	1	3830-146-VIP
152 mm	1	3830-152-VIP
168 mm	1	3830-168
177 mm	1	3830-177-HIGH
210 mm	1	3830-210

Sandflex® bimetallhålsågar, 4-pack



3830-4P

4	19 mm	1 3830-19-4P
4	20 mm	1 3830-20-4P
4	22 mm	1 3830-22-4P
4	25 mm	1 3830-25-4P
4	27 mm	1 3830-27-4P
4	29 mm	1 3830-29-4P
4	30 mm	1 3830-30-4P
4	32 mm	1 3830-32-4P
4	35 mm	1 3830-35-4P

Sats med Sandflex® bimetallhålsågar på
20 x 4 mm + 25 x 4 mm – 11 delar



3834-CP-20/25

600 g		1 3834-CP-20/25

3830-20-Cx 4, 3830-25-Cx 4

3834-ARBR-930

3834-DRLx 2



Sats med Sandflex® bimetallhålsågar på 20–76 mm – 10 delar



3834-PROMO-82

1188 g	1	3834-PROMO-82

- 3830-20-C, 3830-25-C, 3830-30-C, 3830-35-C, 3830-44-C, 3830-51-C, 3830-64-C, 3830-76-C
- 3834-ARBR-930
- 3834-ARBR-11152QC

Sandflex® hålsågssats i bimetall, 19–76 mm – 14 delar



3834-PROMO-122-76

1441 g	1	3834-PROMO-122-76

- 3830-19-C, 3830-20-C, 3830-22-C, 3830-25-C, 3830-27-C, 3830-32-C, 3830-35-C, 3830-38-C, 3830-40-C, 3830-51-C, 3830-64-C, 3830-76-C
- 3834-ARBR-930
- 3834-ARBR-9100

Sats med Sandflex® bimetallhålsågar på 51–111 mm – 6 delar



3834-42

2025 g	1	3834-SET-42

- 3830-51-VIP, 3830-76-VIP, 3830-86-VIP, 3830-111-VIP
- 3834-ARBR-9100
- 3834-ES

Sats med Sandflex® bimetallhålsågar på 16–44 mm – 14 delar



3834-PROMO-122

1100 g	1	3834-PROMO-122

- 3830-16-C, 3830-20-Cx 2, 3830-22-C, 3830-25-Cx 2, 3830-29-C, 3830-32-C, 3830-35-Cx 2, 3830-38-C, 3830-44-C
- 3834-ARBR-930
- 3834-ARBR-11152QC

Sats med Sandflex® bimetallhålsågar 35–83 mm – 9 delar



3834-SET-72-35/83

1613 g	1	3834-SET-72-35/83

- 3830-35-C, 3830-40-C, 3830-44-C, 3830-51-C, 3830-57-C, 3830-68-C, 3830-83-C
- 3834-ARBR-9100
- 3834-DRL

Sats med Sandflex® bimetallhålsågar på 19–79 mm – 13 delar



3834-53

2370 g	1	3834-SET-53

- 3830-19-VIP, 3830-22-VIP, 3830-25-VIP, 3830-29-VIP, 3830-30-VIP, 3830-35-VIP, 3830-37-VIP, 3830-41-VIP, 3830-52-VIP, 3830-60-VIP, 3830-79-VIP
- 3834-ARBR-930
- 3834-ARBR-9100



Sats med Sandflex® bimetallhålsågar på 51–114 mm – 7 delar



3834-61

3145 g	1	3834-SET-61

3830-44-VIP, 3830-51-VIP, 3830-57-VIP, 3830-73-VIP, 3830-86-VIP, 3830-114-VIP	
3834-ARBR-9100	

Sats med Sandflex® bimetallhålsågar på 19–48 mm – 8 delar



3834-62

1050 g	1	3834-SET-62

+ one brush

3830-19-VIP, 3830-21-VIP, 3830-22-VIP, 3830-29-VIP, 3830-38-VIP, 3830-48-VIP	
3834-ARBR-930	
3834-ARBR-9100	

Sats med Sandflex® bimetallhålsågar för metall och träskivor på 16–50 mm – 8 delar



3834-62-16/50

1065 g	1	3834-SET-62-16/50

One brush

3830-16-VIP, 3830-20-VIP, 3830-25-VIP, 3830-32-VIP, 3830-40-VIP, 3830-50-VIP	
3834-ARBR-9100	
3834-ARBR-930	

Sats med Sandflex® bimetallhålsågar för metall och träskivor på 16–51 mm – 9 delar



3834-65-16/51

1465 g	1	3834-SET-65-16/51

3830-16-VIP, 3830-20-VIP, 3830-25-VIP, 3830-32-VIP, 3830-40-VIP, 3830-51-VIP	
3834-ARBR-1130	
3834-ARBR-11152	
3834-DRL	

Sats med Sandflex® bimetallhålsågar för metall och träskivor på 22–64 mm – 9 delar



3834-65-22/64

1625 g	1	3834-SET-65-22/64

3830-22-VIP, 3830-29-VIP, 3830-35-VIP, 3830-44-VIP, 3830-51-VIP, 3830-64-VIP	
3834-ARBR-1130	
3834-ARBR-11152	
3834-DRL	

Sats med Sandflex® bimetallhålsågar på 19–64 mm – 9 delar



3834-72

1080 g	1	3834-SET-72

3830-19-VIP, 3830-22-VIP, 3830-29-VIP, 3830-35-VIP, 3830-44-VIP, 3830-51-VIP, 3830-64-VIP	
3834-ARBR-930	
3834-ARBR-9100	

Sats med Sandflex® bimetallhålsågar på 16–92 mm – 9 delar



3834-73

g 2080 g 1 3834-SET-73

- 3830-16-VIP, 3830-22-VIP, 3830-51-VIP, 3830-57-VIP, 3830-73-VIP, 3830-76-VIP, 3830-92-VIP
- 3834-ARBR-930
- 3834-ARBR-9100

Sats med Sandflex® bimetallhålsågar på 22–68 mm – 10 delar



3834-73-22/68

g 2170 g 1 3834-SET-73-22/68

- 3830-22-VIP, 3830-29-VIP, 3830-35-VIP, 3830-44-VIP, 3830-51-VIP, 3830-64-VIP, 3830-68-VIP
- 3834-ARBR-1130
- 3834-ARBR-11152
- 3834-DRL

Sats med Sandflex® bimetallhålsågar på 16–86 mm – 13 delar



3834-SET-77

g 3325 g 1 3834-SET-77

- 3830-16-VIP, 3830-20-VIP, 3830-25-VIP, 3830-32-VIP, 3830-41-VIP, 3830-51-VIP, 3830-73-VIP, 3830-76-VIP, 3830-83-VIP, 3830-86-VIP
- 3834-ARBR-930
- 3834-ARBR-9100
- 3834-DRL

Sats med Sandflex® bimetallhålsågar på 25–114 mm – 12 delar



3834-SET-84-ES

g 3600 g 1 3834-SET-84-ES

- 3830-25-C, 3830-30-C, 3830-35-C, 3830-51-C, 3830-54-C, 3830-76-C, 3830-92-C, 3830-114-C
- 3834-ARBR-930ESM, 3834-ARBR-9100ESM
- 3834-DRL-HSS-ES
- 3834-UPSIZ

Sats med Sandflex® bimetallhålsågar på 25–114 mm – 12 delar



3834-86

g 2540 g 1 3834-SET-86

- 3830-25-VIP, 3830-32-VIP, 3830-35-VIP, 3830-51-VIP, 3830-54-VIP, 3830-76-VIP, 3830-92-VIP, 3830-114-VIP
- 3834-ARBR-1130
- 3834-ARBR-11152
- 3834-DRLx 2
- 3834-ADP

Sats med Sandflex® bimetallhålsågar på 19–65 mm – 12 delar



3834-87

g 1925 g 1 3834-SET-87

- 3830-19-VIP, 3830-22-VIP, 3830-29-VIP, 3830-38-VIP, 3830-43-VIP, 3830-48-VIP, 3830-52-VIP, 3830-65-VIP
- 3834-ARBR-930
- 3834-ARBR-9100
- 3834-DRL
- 3834-ES



Sats med Sandflex® bimetallhålsågar för metall och träskivor på 16–83 mm – 11 delar



3834-92



1440 g



1 3834-SET-92

3830-16-VIP, 3830-22-VIP, 3830-25-VIP,
3830-29-VIP, 3830-32-VIP, 3830-41-VIP,
3830-51-VIP, 3830-73-VIP, 3830-83-VIP

3834-ARBR-930

3834-ARBR-9100



Sats med Sandflex® bimetallhålsågar på 16–83 mm – 12 delar



3834-93



2360 g



1 3834-SET-93

3830-16-VIP, 3830-20-VIP, 3830-25-VIP,
3830-32-VIP, 3830-40-VIP, 3830-51-VIP,
3830-67-VIP, 3830-76-VIP, 3830-83-VIP

3834-ARBR-930

3834-ARBR-9100QC

3834-DRL



Sats med Sandflex® bimetallhålsågar för metall och träskivor på 16–67 mm – 11 delar



3834-94



1815 g



1 3834-SET-94

3830-16-VIP, 3830-19-VIP, 3830-22-VIP,
3830-25-VIP, 3830-30-VIP, 3830-35-VIP,
3830-41-VIP, 3830-51-VIP, 3830-67-VIP

3834-ARBR-1130

3834-ARBR-11152



Sats med Sandflex® bimetallhålsågar för metall och träskivor på 16–64 mm – 12 delar



3834-95



1350 g



1 3834-SET-95

3830-16-VIP, 3830-19-VIP, 3830-22-VIP,
3830-29-VIP, 3830-35-VIP, 3830-44-VIP,
3830-52-VIP, 3830-57-VIP, 3830-64-VIP

3834-ARBR-1130

3834-ARBR-11152

3834-DRL



Sats med Sandflex® bimetallhålsågar på 16–67 mm – 11 delar



3834-103



2015 g



1 3834-SET-103

3830-16-VIP, 3830-19-VIP, 3830-24-VIP,
3830-29-VIP, 3830-38-VIP, 3830-44-VIP,
3830-57-VIP, 3830-67-VIP

3834-ARBR-1130

3834-ARBR-11152

3834-DRL



Sats med Sandflex® bimetallhålsågar på 16–83 mm – 18 delar



3834-SET-152



3770 g



1 3834-SET-152

3830-16-VIP, 3830-19-VIP, 3830-22-VIP,
3830-25-VIP, 3830-32-VIP, 3830-35-VIP,
3830-44-VIP, 3830-51-VIP, 3830-57-VIP,
3830-60-VIP, 3830-65-VIP, 3830-68-VIP,
3830-73-VIP, 3830-76-VIP, 3830-83-VIP

3834-ARBR-930

3834-ARBR-9100

3834-DRLx 2



Sats med Superior™ universalhålsågar för trä och tegelsten 19 mm-225 mm



3833

19 mm	1	3833-19-C
20 mm	1	3833-20-C
22 mm	1	3833-22-C
25 mm	1	3833-25-C
27 mm	1	3833-27-C
29 mm	1	3833-29-C
30 mm	1	3833-30-C
32 mm	1	3833-32-C
35 mm	1	3833-35-C
38 mm	1	3833-38-C
40 mm	1	3833-40-C
41 mm	1	3833-41-C
44 mm	1	3833-44-C
48 mm	1	3833-48-C
51 mm	1	3833-51-C
54 mm	1	3833-54-C
56 mm	1	3833-56-C
57 mm	1	3833-57-C
60 mm	1	3833-60-C
62 mm	1	3833-62-C
64 mm	1	3833-64-C
65 mm	1	3833-65-C
67 mm	1	3833-67-C
68 mm	1	3833-68-C
70 mm	1	3833-70-C
71 mm	1	3833-71-C
73 mm	1	3833-73-C
74 mm	1	3833-74-C
76 mm	1	3833-76-C
77 mm	1	3833-77-C
78 mm	1	3833-78-C
79 mm	1	3833-79-C
83 mm	1	3833-83-C
86 mm	1	3833-86-C
89 mm	1	3833-89-C
92 mm	1	3833-92-C
95 mm	1	3833-95-C
98 mm	1	3833-98-C
102 mm	1	3833-102-C
105 mm	1	3833-105-C
108 mm	1	3833-108-C
109 mm	1	3833-109-C
111 mm	1	3833-111-C
114 mm	1	3833-114-C
121 mm	1	3833-121-C
127 mm	1	3833-127-C
133 mm	1	3833-133-C
140 mm	1	3833-140-C
152 mm	1	3833-152-C
159 mm	1	3833-159-C
168 mm	1	3833-168
177 mm	1	3833-177
210 mm	1	3833-210
225 mm	1	3833-225

Superior™ sats med universalhålsågar 32–83 mm – 6 delar



3833-PROMO-42

g		
1489 g	1	3833-PROMO-42
3833-32-C, 3833-51-C, 3833-76-C, 3833-83-C		
3834-ARBR-9100EL		
3834-UPSIZ		

Sats med Superior™ universalhålsågar på 19 mm-64 mm–10 delar



3833-SET-101

kg		
2.75 kg	1	3833-SET-101
3833-19-C, 3833-22-C, 3833-29-C, 3833-35-C, 3833-44-C, 3833-51-C, 3833-64-C		
3834-ARBR-930EL, 3834-ARBR-9100EL		
3834-DRL-EL		

Sats med Superior™ universalhålsågar på 19–86 mm–14 st



3833-SET-201

kg		
4.35 kg	1	3833-SET-201
3833-19-C, 3833-20-C, 3833-25-C, 3833-32-C, 3833-41-C, 3833-51-C, 3833-73-C, 3833-76-C, 3833-83-C, 3833-86-C		
3834-ARBR-930EL, 3834-ARBR-9100EL		
3834-DRL-EL		
3834-UPSIZ		

Sats med Superior™ universalhålsågar på 19–83 mm–14 delar



3833-SET-202

kg		
4.1 kg	1	3833-SET-202
3833-19-C, 3833-20-C, 3833-25-C, 3833-32-C, 3833-41-C, 3833-51-C, 3833-57-C, 3833-60-C, 3833-73-C, 3833-83-C		
3834-ARBR-930EL, 3834-ARBR-9100EL		
3834-DRL-EL		
3834-UPSIZ		



Sats med Superior™ universalhålsågar på 19–78 mm–14 delar



3833-SET-203

kg 4.65 kg 1 3833-SET-203

- 3833-19-C, 3833-22-C, 3833-54-C, 3833-56-C, 3833-57-C, 3833-62-C, 3833-68-C, 3833-71-C, 3833-74-C, 3833-78-C
- 3834-ARBR-930EL, 3834-ARBR-9100EL
- 3834-DRL-EL
- 3834-UPSIZE

Sats med Superior™ universalhålsågar på 22–67 mm–9 delar



3833-SET-205

kg 2.81 kg 1 3833-SET-205

- 3833-22-C, 3833-35-C, 3833-44-C, 3833-51-C, 3833-67-C
- 3834-ARBR-930EL, 3834-ARBR-9100EL
- 3834-DRL-EL
- 3834-UPSIZE

Sats med Superior™ universalhålsågar på 19–76 mm–15 delar



3833-SET-208

kg 3.72 kg 1 3833-SET-208

- 3833-19-C, 3833-22-C, 3833-25-C, 3833-32-C, 3833-35-C, 3833-38-C, 3833-44-C, 3833-51-C, 3833-57-C, 3833-68-C, 3833-76-C
- 3834-ARBR-930EL, 3834-ARBR-9100EL
- 3834-DRL-EL
- 3834-UPSIZE

Sats med Superior™ universalhålsågar på 32–86 mm–10 delar



3833-SET-204

kg 3.88 kg 1 3833-SET-204

- 3833-32-C, 3833-41-C, 3833-51-C, 3833-73-C, 3833-76-C, 3833-83-C, 3833-86-C
- 3834-ARBR-9100EL
- 3834-DRL-EL
- 3834-UPSIZE

Sats med Superior™ universalhålsågar på 19–83 mm–14 st



3833-SET-207

kg 3.90 kg 1 3833-SET-207

- 3833-19-C, 3833-22-C, 3833-25-C, 3833-35-C, 3833-44-C, 3833-51-C, 3833-64-C, 3833-67-C, 3833-76-C, 3833-83-C
- 3834-ARBR-930EL, 3834-ARBR-9100EL
- 3834-DRL-EL
- 3834-UPSIZE

Sats med Superior™ universalhålsågar på 25–114 mm–12 st



3833-SET-301

kg 4.38 kg 1 3833-SET-301

- 3833-25-C, 3833-32-C, 3833-35-C, 3833-51-C, 3833-54-C, 3833-76-C, 3833-92-C, 3833-114-C
- 3834-ARBR-930EL, 3834-ARBR-9100EL
- 3834-DRL-EL
- 3834-UPSIZE

Sats med Superior™ universalhålsågar på 51–111 mm–7 delar



3833-SET-302

kg		
3.51 kg	1	3833-SET-302

3833-51-C, 3833-76-C, 3833-86-C, 3833-111-C	
3834-ARBR-9100EL	
3834-DRL-EL	
3834-UPSIZ	

Sats med Superior™ universalhålsågar på 35–114 mm–11 delar



3833-SET-303

kg		
4.17 kg	1	3833-SET-303

3833-35-C, 3833-40-C, 3833-51-C, 3833-57-C, 3833-60-C, 3833-74-C, 3833-83-C, 3833-105-C	
3834-ARBR-9100EL	
3834-DRL-EL	
3834-UPSIZ	

Sats med Superior™ universalhålsågar på 19–114 mm–13 st



3833-SET-304

kg		
4.20 kg	1	3833-SET-304

3833-19-C, 3833-25-C, 3833-32-C, 3833-35-C, 3833-51-C, 3833-54-C, 3833-76-C, 3833-92-C, 3833-114-C	
3834-ARBR-930EL, 3834-ARBR-9100EL	
3834-DRL-EL	
3834-UPSIZ	

Hålsågar med hårdmetallbestyckade tänder för glasfiber och murverk 14 mm–152 mm



3832

kg		
14 mm	6	3832-14
16 mm	6	3832-16
17 mm	6	3832-17
19 mm	6	3832-19

20 mm	6 3832-20
21 mm	6 3832-21
22 mm	6 3832-22
24 mm	6 3832-24
25 mm	6 3832-25
27 mm	6 3832-27
29 mm	6 3832-29
30 mm	6 3832-30
32 mm	6 3832-32
33 mm	6 3832-33
35 mm	6 3832-35
37 mm	6 3832-37
38 mm	6 3832-38
40 mm	6 3832-40
41 mm	6 3832-41
43 mm	6 3832-43
44 mm	6 3832-44
46 mm	6 3832-46
48 mm	6 3832-48
51 mm	6 3832-51
52 mm	4 3832-52
54 mm	4 3832-54
56 mm	4 3832-56
57 mm	4 3832-57
59 mm	4 3832-59
60 mm	4 3832-60
64 mm	4 3832-64
65 mm	4 3832-65
67 mm	4 3832-67
68 mm	4 3832-68
70 mm	4 3832-70
73 mm	4 3832-73
76 mm	4 3832-76
79 mm	4 3832-79
83 mm	4 3832-83
86 mm	4 3832-86
89 mm	4 3832-89
92 mm	4 3832-92
95 mm	4 3832-95
98 mm	4 3832-98
102 mm	4 3832-102
105 mm	4 3832-105
108 mm	4 3832-108
111 mm	4 3832-111
114 mm	4 3832-114
121 mm	1 3832-121
127 mm	1 3832-127
133 mm	1 3832-133
140 mm	1 3832-140
146 mm	1 3832-146
152 mm	1 3832-152



Hålsågar med hårdmetalltänder för rostfritt stål, 16–127 mm



3832-C

16 mm	1	3832-16-C
19 mm	1	3832-19-C
20 mm	1	3832-20-C
22 mm	1	3832-22-C
24 mm	1	3832-24-C
25 mm	1	3832-25-C
29 mm	1	3832-29-C
30 mm	1	3832-30-C
32 mm	1	3832-32-C
35 mm	1	3832-35-C
38 mm	1	3832-38-C
41 mm	1	3832-41-C
44 mm	1	3832-44-C
46 mm	1	3832-46-C
48 mm	1	3832-48-C
51 mm	1	3832-51-C
54 mm	1	3832-54-C
57 mm	1	3832-57-C
60 mm	1	3832-60-C
64 mm	1	3832-64-C
73 mm	1	3832-73-C
76 mm	1	3832-76-C
83 mm	1	3832-83-C
86 mm	1	3832-86-C
92 mm	1	3832-92-C
102 mm	1	3832-102-C
114 mm	1	3832-114-C
127 mm	1	3832-127-C

Hålsågssats, med hårdmetalltänder för rostfritt stål 25–114 mm – 12 delar



3832-SET-84-ES

g	X	g	X
3600 g	10	3870 g	1
			3832-SET-84-ES

3832-25-C, 3832-30-C, 3832-35-C, 3832-51-C, 3832-54-C, 3832-76-C, 3832-92-C, 3832-114-C	
3834-ARBR-9100ESM, 3834-ARBR-930ESM	
3834-DRL-HSS-ES	
3834-UPSIZ	

Hålsågssats med hårdmetallbestyckade tänder för rostfritt stål, 16–114 mm – 20 st.



3832-SET-164-ES

g	X	g	X
4800 g	1		3832-SET-164-ES

3832-16-C, 3832-20-C, 3832-25-C, 3832-32-C, 3832-35-C, 3832-41-C, 3832-44-C, 3832-46-C, 3832-51-C, 3832-54-C, 3832-57-C, 3832-60-C, 3832-64-C, 3832-73-C, 3832-76-C, 3832-83-C, 3832-86-C, 3832-92-C, 3832-114-C	
3834-ARBR-9100ESM, 3834-ARBR-930ESM	
3834-DRL-HSS-ES	
3834-UPSIZ	

Hålsågssats, blandad, 35–114 mm – 10 delar



3835-SET-64

X	g	X
10	3870 g	1
		3835-SET-64

3830-35-C, 3830-73-C	
3833-35-C, 3833-73-C, 3833-76-C, 3833-114-C	
3834-ARBR-9100QC-C	
3834-ARBR-9100EL	
3834-DRL-EL	
3834-DRL	

Hålsågssats, blandad, 12–86 mm – 18 delar



3835-SET-711

X	g	X
18	3680 g	1
		3835-SET-711

3830-35-C, 3830-41-C, 3830-51-C, 3830-73-C, 3830-76-C, 3830-83-C, 3830-86-C	
9629-12, 9629-14, 9629-16, 9629-18, 9629-20, 9629-22, 9629-25, 9629-28, 9629-32	
3834-ARBR-9100ESM	
3834-DRL-HSS-ES	

Hållare med Quick-Eject-funktion – sparar tid och energi



3834-ARBR-EL/ES

19-30 mm	8.5 mm	1	3834-ARBR-930EL
32-159 mm	8.5 mm	1	3834-ARBR-9100EL
16-30 mm	8.5 mm	1	3834-ARBR-930ESM
32-152 mm	8.5 mm	1	3834-ARBR-9100ESM

Centrumborr för långa Quick-Eject-hållare



3834-DRL-EL

6.35 mm	202 mm	1	3834-DRL-EL
---------	--------	---	-------------

Centrumborr för korta Quick-Eject-hållare



3834-DRL-HSS-ES

Ø	L	Icon	Part No.
6.35 mm	138 mm		1 3834-DRL-ES
6.35 mm	138 mm		1 3834-DRL-HSS-ES

Utvidgningsadapter för förstoring av befintliga hål



3834-upsizer

L	Icon	Part No.
20,5 mm		1 3834-UPSIZER

Hållare för små hålsågar, 14–30 mm



3834-ARBR

Ø	L	Icon	Part No.
14-30 mm	6.4 mm		1 3834-ARBR-630
14-30 mm	6.4 mm		1 3834-ARBR-630-C
14-30 mm	6.4 mm		1 3834-ARBR-730
14-30 mm	6.4 mm		1 3834-ARBR-730-C
14-30 mm	8.5 mm		1 3834-ARBR-930
14-30 mm	8.5 mm		1 3834-ARBR-930-C
14-30 mm	11.1 mm		4 3834-ARBR-1130
14-30 mm	11.1 mm		1 3834-ARBR-1130-C

Hållare med snabbfäste



3834-ARBR-QC

Ø	L	Icon	Part No.
32-152 mm	8.5 mm		1 3834-ARBR-9100
32-152 mm	8.5 mm		1 3834-ARBR-9100-C
32-152 mm	8.5 mm		1 3834-ARBR-9100QC
32-152 mm	8.5 mm		1 3834-ARBR-9100QC-C
32-210 mm	11.1 mm		1 3834-ARBR-11152
32-210 mm	11.1 mm		1 3834-ARBR-11152-C
32-210 mm	11.1 mm		1 3834-ARBR-11152QC
32-210 mm	11.1 mm		1 3834-ARBR-11152QC-C
32-210 mm	15.4 mm		1 3834-ARBR-16152
32-210 mm	15.4 mm		1 3834-ARBR-16152QC

Hållare med SDS Plus-fäste



3834-ARBR-SD

Ø	L	Icon	Part No.
14-30 mm	SDS+ mm		1 3834-ARBR-SD30
32-210 mm	SDS+ mm		1 3834-ARBR-SD152QC

Centrumborr i snabbstål för hålsågshållare



3834-DRL

Ø	L	Icon	Part No.
6.35 mm	81 mm		1 3834-DRL

Centrumborrar med hårdmetallspets för hålsågshållare



3834-DRL-CT/L

Ø	L	Icon	Part No.
6.35 mm	81 mm		1 3834-DRL-CT
6.35 mm	114 mm		1 3834-DRL-L

Hållarförlängare



3834-EXT

Ø	L	Icon	Part No.
11.1 mm	330 mm		1 3834-EXT-1
8.5 mm	330 mm		1 3834-EXT-2

Utstötarfjäder för hållare



3834-ES

g	Icon	Part No.
10 g		1 3834-ES



Hållaradapter för 3834-ARBR-630, 730, 930 och 1130



3834-ADP

20 g	1	3834-ADP

Skrivar för hållare



3834-SCREWS

9 g	1	3834-M6X29-SET
9 g	1	3834-M8X5-SET
9 g	1	3834-M8X6-SET
9 g	1	3834-M8X10-SET

TIGERSÅGBLAD

Sats med Sandflex® tigersågblad i bimetall för metall



3940-M

100 mm	14	10	3940-100-14-ST-2P
100 mm	14	5	3940-100-14-ST-5P
100 mm	14	1	3940-100-14-ST-10P
100 mm	18	10	3940-100-18-ST-2P
100 mm	18	5	3940-100-18-ST-5P
100 mm	18	1	3940-100-18-ST-10P
150 mm	14	5	3940-150-14-ST-2P
150 mm	14	5	3940-150-14-ST-5P

150 mm	14	1	3940-150-14-ST-10P
150 mm	14	1	3940-150-14-ST-100P
150 mm	18	10	3940-150-18-ST-2P
150 mm	18	5	3940-150-18-ST-5P
150 mm	18	1	3940-150-18-ST-10P
150 mm	18	1	3940-150-18-ST-100P
228 mm	14	10	3940-228-14-ST-2P
228 mm	14	5	3940-228-14-ST-5P
228 mm	14	1	3940-228-14-ST-10P
228 mm	14	1	3940-228-14-ST-100P
228 mm	18	10	3940-228-18-ST-2P
228 mm	18	5	3940-228-18-ST-5P
228 mm	18	1	3940-228-18-ST-10P
228 mm	18	1	3940-228-18-ST-100P
300 mm	14	5	3940-300-14-ST-2P
300 mm	14	5	3940-300-14-ST-5P
300 mm	14	1	3940-300-14-ST-10P
300 mm	14	1	3940-300-14-ST-100P
300 mm	18	10	3940-300-18-ST-2P
300 mm	18	5	3940-300-18-ST-5P
300 mm	18	1	3940-300-18-ST-10P
300 mm	18	1	3940-300-18-ST-100P

Sats med Sandflex® tigersågblad i bimetall för kraftig metall



3940-HM

150 mm	8/12	10	3940-150-8/12-ST-2P
150 mm	8/12	5	3940-150-8/12-ST-5P
150 mm	8/12	1	3940-150-8/12-ST-10P
150 mm	8/12	1	3940-150-8/12-ST-100P
228 mm	8/12	10	3940-228-8/12-ST-2P
228 mm	8/12	5	3940-228-8/12-ST-5P
228 mm	8/12	1	3940-228-8/12-ST-10P
228 mm	8/12	1	3940-228-8/12-ST-100P
150 mm	10	10	3940-150-10-HST-2P
150 mm	10	5	3940-150-10-HST-5P
150 mm	10	1	3940-150-10-HST-10P
150 mm	10	1	3940-150-10-ST-100P
150 mm	10	10	3940-150-10-ST-2P
150 mm	10	5	3940-150-10-ST-5P
150 mm	10	1	3940-150-10-ST-10P
150 mm	14	10	3940-150-14-HST-2P
150 mm	14	5	3940-150-14-HST-5P
150 mm	14	1	3940-150-14-HST-10P
150 mm	18	10	3940-150-18-HST-2P
150 mm	18	5	3940-150-18-HST-5P
150 mm	18	1	3940-150-18-HST-10P
228 mm	10	10	3940-228-10-HST-2P
228 mm	10	5	3940-228-10-HST-5P
228 mm	10	1	3940-228-10-HST-10P
228 mm	10	1	3940-228-10-HST-100P
228 mm	10	10	3940-228-10-ST-2P
228 mm	10	5	3940-228-10-ST-5P
228 mm	10	1	3940-228-10-ST-10P
228 mm	10	1	3940-228-10-ST-100P
228 mm	14	10	3940-228-14-HST-2P

228 mm	14	5	3940-228-14-HST-5P
228 mm	14	1	3940-228-14-HST-10P
228 mm	18	10	3940-228-18-HST-2P
228 mm	18	5	3940-228-18-HST-5P
228 mm	18	1	3940-228-18-HST-10P
300 mm	10	10	3940-300-10-HST-2P
300 mm	10	5	3940-300-10-HST-5P
300 mm	10	1	3940-300-10-HST-10P
300 mm	14	10	3940-300-14-HST-2P
300 mm	14	5	3940-300-14-HST-5P
300 mm	14	1	3940-300-14-HST-10P
300 mm	18	10	3940-300-18-HST-2P
300 mm	18	5	3940-300-18-HST-5P
300 mm	18	1	3940-300-18-HST-10P

Sats med Sandflex® tigersågblad i bimetall för tunnmetall



3940-FM

100 mm	24	10	3940-100-24-ST-2P
100 mm	24	5	3940-100-24-ST-5P
100 mm	24	1	3940-100-24-ST-10P
150 mm	24	5	3940-150-24-ST-2P
150 mm	24	5	3940-150-24-ST-5P
150 mm	24	1	3940-150-24-ST-10P
150 mm	24	1	3940-150-24-ST-100P

Sats med Sandflex® tigersågblad i bimetall för precisionssågning i metall



3940-PM

100 mm	14	10	3940-100-14-SC-2P
100 mm	14	5	3940-100-14-SC-5P
100 mm	18	10	3940-100-18-SC-2P
100 mm	18	5	3940-100-18-SC-5P
100 mm	24	10	3940-100-24-SC-2P
100 mm	24	5	3940-100-24-SC-5P

Tigersågblad med hårdmetalltänder för kraftig metall



3946-C HM

Bladdlängd	Tänder	Antal	Modell
150 mm	8	10	3946-150-8-HST-1P
228 mm	8	10	3946-228-8-HST-1P
300 mm	8	10	3946-300-8-HST-1P

Tigersågblad med hårdmetalltänder för rostfritt stål



3946-C SS

Bladdlängd	Tänder	Antal	Modell
150 mm	10	10	3946-150-10-HST-1P
228 mm	10	10	3946-228-10-HST-1P
300 mm	10	10	3946-300-10-HST-1P

Tigersågblad med diamanthör för gjutjärn och keramik



3946-D CI

Bladdlängd	Tänder	Antal	Modell
100 mm	Grit	10	3946-100-DG-ST-2P
150 mm	Grit	10	3946-150-DG-ST-2P

Sandflex® tigersågblad i bimetallblad för karosseriarbeten



3845

Bladdlängd	Tänder	Antal	Modell
91,5 mm	18	1	3845-18-10P
91,5 mm	24	1	3845-24-10P
90 mm	32	1	3845-32-10P

Sandflex® tigersågblad i bimetall för trä och metall



3940-WM

Bladdlängd	Tänder	Antal	Modell
150 mm	4/6	10	3940-150-4/6-SC-2P
150 mm	4/6	5	3940-150-4/6-SC-5P
150 mm	4/6	1	3940-150-4/6-SC-10P
150 mm	5/8	10	3940-150-5/8-SL-2P
150 mm	5/8	5	3940-150-5/8-SL-5P
150 mm	5/8	1	3940-150-5/8-SL-10P
150 mm	5/8	1	3940-150-5/8-SL-100P
150 mm	6	10	3940-150-6-ST-2P
150 mm	6	5	3940-150-6-ST-5P
150 mm	6	1	3940-150-6-ST-10P
228 mm	6	10	3940-228-6-SL-2P
228 mm	6	5	3940-228-6-SL-5P
228 mm	6	1	3940-228-6-SL-10P
300 mm	6	10	3940-300-6-SL-2P
300 mm	6	5	3940-300-6-SL-5P
300 mm	6	1	3940-300-6-SL-10P
300 mm	8/12	5	3940-300-8/12-SL-2P
300 mm	8/12	5	3940-300-8/12-SL-5P
300 mm	8/12	1	3940-300-8/12-SL-10P
300 mm	8/12	1	3940-300-8/12-SL-100P

Sandflex® tigersågblad i metall för räddningspersonal



3940-FR

Bladdlängd	Tänder	Antal	Modell
228 mm	10	10	3940-228-10-DSL-2P
228 mm	10	5	3940-228-10-DSL-5P
228 mm	10	1	3940-228-10-DSL-10P
228 mm	10	1	3940-228-10-DSL-100P

Sandflex® tigersågblad i bimetall för rivningsarbeten



3940-D

Bladdlängd	Tänder	Antal	Modell
150 mm	5/8	10	3940-150-5/8-DSL-2P
150 mm	5/8	5	3940-150-5/8-DSL-5P
150 mm	5/8	1	3940-150-5/8-DSL-10P
228 mm	5/8	10	3940-228-5/8-DSL-2P
228 mm	5/8	5	3940-228-5/8-DSL-5P
228 mm	5/8	1	3940-228-5/8-DSL-10P
300 mm	5/8	10	3940-300-5/8-DSL-2P
300 mm	5/8	5	3940-300-5/8-DSL-5P
300 mm	5/8	1	3940-300-5/8-DSL-10P

Sandflex® tigersågblad i bimetall för lastpallsreparationer



3940-PR

Bladdlängd	Tänder	Antal	Modell
228 mm	10/14	1	3940-228-10/14-PR13-10P
228 mm	10/14	1	3940-228-10/14-PR09-10P
228 mm	10/14	1	3940-228-10/14-PR09-100P
228 mm	10/14	1	3940-228-10/14-PR13-100P
228 mm	8/12	1	3940-228-8/12-PR13-100P
228 mm	10	1	3940-228-10-PR09-100P



Tigersågblad med hårdmetalltänder för trä och spik



3946-C_WM

Bladdlängd	Tänder	Antal	Varuslag
150 mm	6	10	3946-150-6-DSL-1P
228 mm	6	10	3946-228-6-DSL-1P
300 mm	6	10	3946-300-6-DSL-1P

HCS-tigersågblad för trä och plast



3942-WP

Bladdlängd	Tänder	Antal	Varuslag
228 mm	11	10	3942-228-11-HSL-2P
228 mm	11	5	3942-228-11-HSL-5P
228 mm	11	1	3942-228-11-HSL-10P

Böjt tigersågblad för medelgrova snitt



3943-C30-JT-M

Bladdlängd	Bladdbredd	Antal	Varuslag
323 mm	13 in	10	3943-C30-JT-M
373 mm	15 in	10	3943-C35-JT-M

HCS-tigersågblad för trä



3942-W

Bladdlängd	Tänder	Antal	Varuslag
228 mm	7	10	3942-228-7-HSL-2P
228 mm	7	5	3942-228-7-HSL-5P
228 mm	7	1	3942-228-7-HSL-10P
300 mm	7	10	3942-300-7-HSL-2P
300 mm	7	5	3942-300-7-HSL-5P
300 mm	7	1	3942-300-7-HSL-10P

Sandflex® tigersågblad i bimetall för gips och träskivor



3942-PB

Bladdlängd	Tänder	Antal	Varuslag
150 mm	7	10	3942-150-7-SL-2P
150 mm	7	5	3942-150-7-SL-5P
150 mm	7	1	3942-150-7-SL-10P
228 mm	7	10	3942-228-7-SL-2P
228 mm	7	5	3942-228-7-SL-5P
228 mm	7	1	3942-228-7-SL-10P
300 mm	7	10	3942-300-7-SL-2P
300 mm	7	5	3942-300-7-SL-5P
300 mm	7	1	3942-300-7-SL-10P

Böjt långt tigersågblad för grova snitt



3943-C35-JT-C

Bladdlängd	Bladdbredd	Antal	Varuslag
373 mm	15 in	10	3943-C35-JT-C

HCS-tigersågblad för grovt trä



3942-CW

Bladdlängd	Tänder	Antal	Varuslag
228 mm	5	10	3942-228-5-HSL-2P
228 mm	5	5	3942-228-5-HSL-5P
228 mm	5	1	3942-228-5-HSL-10P
300 mm	5	10	3942-300-5-HSL-2P
300 mm	5	5	3942-300-5-HSL-5P
300 mm	5	1	3942-300-5-HSL-10P

Böjt tigersågblad för fina snitt



3943-C30-JT-F

Bladdlängd	Bladdbredd	Antal	Varuslag
323 mm	13 in	10	3943-C30-JT-F

Rakt tigersågblad för fina snitt



3943-S20-JT-F

Bladdlängd	Bladdbredd	Antal	Varuslag
228 mm	9 in	10	3943-S20-JT-F

Rakt tigersågblad för grova snitt



3943-R28-UT-C-2P

300 mm	12 in	10	3943-R28-UT-C-2P

Sats med Sandflex® tigersågblad i bimetall för kraftig metall och rivningsarbeten – 5 st.



3940-HDD-SET-5P

5	222 g	5	3940-HDD-SET-5P

3940-150-5/8-DSL, 3940-228-5/8-DSL, 3940-228-10-DSL, 3940-150-14-HST, 3940-228-14-HST, 3940-150-5/8-DSL, 3940-228-5/8-DSL, 3940-228-10-DSL, 3940-150-14-HST, 3940-228-14-HST

Sats med tigersågblad för trä och metall – 12 st.



3940-MIX-SET-12P

12	480 g	6	3940-MIX-SET-12P

3940-228-10-HST, 2 x 3940-228-14-ST, 3940-228-18-ST, 3940-150-10-ST, 3940-150-14-ST, 3940-150-18-ST, 3940-228-5/8-DSL, 3940-228-6-SL, 3942-150-7-SL, 3942-228-7-HSL, 3942-228-11-HSL

Sats med Sandflex® tigersågblad i bimetall för metall – 5 st.



3940-METAL-SET-5P

5	125 g	5	3940-METAL-SET-5P

3940-150-14-ST, 3940-150-18-ST, 3940-150-24-ST, 3940-228-18-ST, 3940-228-14-ST, 3940-150-14-ST, 3940-150-18-ST, 3940-150-24-ST, 3940-228-18-ST, 3940-228-14-ST

Sats med tigersågblad för trä och metall – 5 st.



3940-MIX-SET-5P

5	150 g	5	3940-MIX-SET-5P

3940-100-24-SC, 3940-150-18-ST, 3940-150-14-ST, 3940-228-6-SL, 3942-228-7-HSL, 3940-100-24-SC, 3940-150-18-ST, 3940-150-14-ST, 3940-228-6-SL, 3942-228-7-HSL

Sats med tigersågblad för trä – 5 st.



3942-WOOD-SET-5P

5	191 g	5	3942-WOOD-SET-5P

3940-228-6-SL, 3942-228-11-HSL, 2x 3942-228-7-HSL, 3942-150-7-SL, 3940-228-6-SL, 3942-228-11-HSL, 3942-228-7-HSL, 3942-228-7-HSL, 3942-150-7-SL

Sats med Sandflex® tigersågblad i bimetall för metall – 12 st.



3940-METAL-SET-12P

12	460 g	6	3940-METAL-SET-12P

3940-228-10-HST, 2 x 3940-228-14-ST, 3940-228-18-ST, 3940-150-10-ST, 3940-150-14-ST, 3940-150-18-ST, 3940-150-24-ST, 3942-150-8-HST, 3940-150-5/8-DSL, 3940-228-6-SL, 3942-228-7-HSL

Sats med tigersågblad för gips, trä och metall – 10 st.



3940-MIX-SET-10P

10	245 g	4	3940-MIX-SET-10P

3940-100-24-SC, 3940-100-18-SC, 3940-150-24-ST, 3940-150-18-ST, 3940-150-14-ST, 3940-150-10-ST, 3940-150-14-ST, 3940-150-18-ST, 3940-150-24-ST, 3940-150-18-ST, 3940-150-14-ST, 3940-150-10-ST, 3940-228-6-SL, 3940-228-11-HSL, 3942-228-7-HSL, 3942-150-7-SL

Sats med tigersågblad för trä – 12 st.



3942-WOOD-SET-12P

12	525 g	6	3942-WOOD-SET-12P

3940-228-14-ST, 3940-228-18-ST, 3940-150-14-ST, 3940-150-5/8-DSL, 3940-228-5/8-DSL, 3940-228-6-SL, 3942-228-6-DSL, 3942-150-7-SL, 3942-228-5-HSL, 2 x 3942-228-7-HSL, 3942-228-11-HSL



Tigersågblad i rostfritt stål för kött och is



3944

300 mm	4	10	3944-300-3-MEAT-1P

Tigersågblad med hårdmetalllegg för stenmaterial



3946-CT

150 mm	6	5	3946-150-6-SL-1P
228 mm	3	5	3946-228-3-ST-1P
300 mm	6	5	3946-300-6-ST-1P

Tigersågblad med hårdmetalltänder för tegel, Leca och lättbetong



3946-C_B

300 mm	2	10	3946-300-2-CB-1P
457 mm	2	10	3946-457-2-CB-1P

STICKSÅGBLAD

Sticksågsblad med T-fäste för metallsågning



91-M

100 mm	15/23	1	91-3PM-5P
100 mm	8	1	91-433-5P
77 mm	36	1	91-502-5P

77 mm	21	1	91-512-5P
77 mm	21	1	91-512-25P
77 mm	21	1	91-517-5P
77 mm	13	1	91-522-5P
132 mm	25	1	91-611-5P
77 mm	21	1	91-612-5P
77 mm	13	1	91-622-5P
132 mm	14	1	91-7V1-5P

Sticksågsblad med T-fäste för sågning i trä och metall



91-WM

132 mm	10/14	1	91-4PWM-5P
100 mm	10/14	1	91-623-5P

Sticksågsblad med T-fäste för sågning i trä



91-W

117 mm	10	1	91-2PW-5P
132 mm	8	1	91-434-5P
105 mm	6	1	91-444-5P
100 mm	8	1	91-023-5P
77 mm	12	1	91-027-5P
100 mm	6	1	91-143-5P
100 mm	6	1	91-143-25P
100 mm	6	1	91-143-100P
100 mm	6	1	91-148-5P
100 mm	10	1	91-223-5P
100 mm	10	1	91-226-5P
132 mm	6	1	91-233-5P
100 mm	6	1	91-243-5P
77 mm	19	1	91-412-5P
100 mm	6	1	91-443-5P

Sats med sticksågsblad för metall, 10 delar



91-METAL-10P

10		1	91-METAL-10P
x3 91-512 (T118A), x3 91-522 (T118B), x1 91-433 (T127DF), x1 91-502 (T118G), x2 91-4PWM (T111HF)			

Sats med sticksågsblad för trä och plast, 10 delar



91-WOOD-10P

10		1	91-WOOD-10P
x4 91-143 (T144D), x2 91-223 (T101B), x2 91-023 (T111C), x1 91-148 (T244D), x1 91-226 (T101BR)			

Sats med sticksågsblad för trä och metall, 10 delar



91-MIXED-10P

10		1	91-MIXED-10P
x3 91-143 (T144D), x1 91-223 (T101B), x1 91-148 (T244D), x2 91-512 (T118A), x2 91-522 (T118B), x1 91-623 (T111HF)			

MULTIVERKTYGSTILLBEHÖR

Standardformat blad för multiverktyg, för användning i trä



92-S_W

1		35 x 50 x 97 mm	70	92-133-1P
3		35 x 50 x 97 mm	46	92-133-3P
25		35 x 50 x 97 mm	25	92-133-25

Standardformat blad för multiverktyg, för precisionssäging i trä



92-P_W

1		30 x 50 x 97 mm	70	92-205-1P
3		30 x 50 x 97 mm	46	92-205-3P
25		30 x 50 x 97 mm	25	92-205-25
1		65 x 50 x 97 mm	70	92-229-1P

Böjt standardformat blad för multiverktyg, för användning i trä



92-C_W

1		65 x 50 x 97 mm	70	92-225-1P
25		65 x 50 x 97 mm	25	92-225-25

Standardformat blad för multiverktyg, för universalanvändning i trä med spik



92-U_WN

1		35 x 50 x 97 mm	70	92-160-1P
3		35 x 50 x 97 mm	46	92-160-3P
25		35 x 50 x 97 mm	25	92-160-25

Multiverktyg – extra hållbart standardformat blad för trä med spikar



92-LF_WN

1		50 x 50 x 97 mm	70	92-221-1P
1		65 x 50 x 97 mm	70	92-228-1P
25		65 x 50 x 97 mm	25	92-228-25

Standardformat blad för multiverktyg, för universalanvändning i trä och metall



92-U_WM

1		28 x 55 x 100 mm	70	92-222-1P
3		28 x 55 x 100 mm	46	92-222-3P
25		28 x 55 x 100 mm	25	92-222-25
1		44 x 55 x 100 mm	70	92-223-1P
3		44 x 55 x 100 mm	46	92-223-3P

Hårdmetallblad med TiN-beläggning för multiverktyg, för användning i metall



92-C_M

1		35 x 42 x 82 mm	70	92-236-1P

Standardformat blad för multiverktyg, används för finsäging i metall



92-FM

1		30 x 50 x 97 mm	70	92-157-1P
25		30 x 50 x 97 mm	25	92-157-25

Segmenterat blad för multiverktyg, för användning i metall



92-M_S

1		85 mm	90	92-106-1P



Segmenterat blad för multiverktyg, för användning i trä



92-SP

1	85 mm	90	92-113-1P

Segmenterat blad för multiverktyg, används för urtagning och omarbetning



92-CG_S

1	75 mm	90	92-118-1P

Standardformat knivblad för multiverktyg, för användning i mjuka material



92-MFK

1	41 x 42 x 87 mm	70	92-251-1P

Runt blad för multiverktyg, för användning i metall



92-M_R

115	85 mm	90	92-174-1P

Segmenterat blad för multiverktyg, för användning i marmor och epoxy



92-DG_S

1	90 mm	50	92-166-1P

Standardformat flexibel spackel för multiverktyg



92-SC

1	52 x 38 x 83 mm	90	92-165-1P
1	50 x 38 x 83 mm	90	92-226-1P

Sats med standardformade blad för multiverktyg, för användning i trä och metall. 8 delar



92-Universal_WM_Set

8	32 x 160 x 195 mm	34	92-WM-SET-8P

92-222-1Px 2, 92-223-1Px 2

92-228-1Px 2

92-160-1Px 2

Triangelformat blad för multiverktyg, för raspning och omarbetning



92-CR_T

1	80 mm	90	92-001-1P

Svampformat blad för multiverktyg



92-CM

1	70 x 30 x 75 mm	90	92-245-1P

Triangelformad sandpapperspad för multiverktyg



92-Sanding

1	80 mm	20	92-136-1P	
5	82 mm	10	92-136-G40-5P	
5	82 mm	10	92-136-G80-5P	
5	82 mm	10	92-136-G120-5P	
5	82 mm	10	92-136-G240-5P	
1	93 mm	50	92-137-1P	
5	94 mm	10	92-137-G40-5P	
5	94 mm	10	92-137-G80-5P	
5	94 mm	10	92-137-G120-5P	
5	94 mm	10	92-137-G240-5P	

CIRKELSÅGKLINGOR

Cirkelsågklinga för sladdlösa sågar, för sågning i trä



8501-C

136 mm	24	1	8501-136-10-24C	
136 mm	24	1	8501-136-20-24C	
150 mm	24	1	8501-150-10-24C	
160 mm	24	1	8501-160-20-24C	
165 mm	24	1	8501-165-20-24C	
184 mm	24	1	8501-184-20-24C	
190 mm	24	1	8501-190-30-24C	

Cirkelsågklinga för portabla sågar/bordssågar, för sågning i trä



8501-P/T

125 mm	16	1	8501-2	
130 mm	16	1	8501-3	
140 mm	16	1	8501-4	
140 mm	24	1	8501-4F	
140 mm	30	1	8501-4XF	
150 mm	18	1	8501-5	
150 mm	30	1	8501-5F	
160 mm	18	1	8501-7	
160 mm	30	1	8501-7F	
170 mm	18	1	8501-10	
170 mm	30	1	8501-10F	
180 mm	20	1	8501-12	
180 mm	40	1	8501-12F	
184 mm	24	1	8501-13	
184 mm	40	1	8501-13F	
184 mm	24	1	8501-184-16-24	
184 mm	40	1	8501-184-16-40	
190 mm	20	1	8501-15	
190 mm	40	1	8501-15F	
190 mm	60	1	8501-190-30-60XF	
200 mm	20	1	8501-16	
200 mm	40	1	8501-16F	
210 mm	20	1	8501-17	
210 mm	40	1	8501-17F	
210 mm	60	1	8501-210-30-60XF	
230 mm	20	1	8501-22	
230 mm	40	1	8501-22F	
230 mm	60	1	8501-230-30-60XF	
235 mm	30	1	8501-23	
235 mm	40	1	8501-23F	
235 mm	60	1	8501-235-30-60XF	
250 mm	24	1	8501-28	
250 mm	40	1	8501-28F	
250 mm	60	1	8501-28XF	

Cirkelsågklinga för sänksåg, för sågning i trä



8501-P_

160 mm	48	1	8501-160-20-48XF	
165 mm	48	1	8501-165-20-48XF	

Cirkelsågklinga för kapsåg, för sågning i trä



8501-M

210 mm	48	1	8501-210-30-48SW	
216 mm	24	1	8501-16SW	
216 mm	48	1	8501-18SW	
216 mm	60	1	8501-216-60SW	
250 mm	60	1	8501-28SW	
260 mm	24	1	8501-260-24SW	
260 mm	40	1	8501-260-40SW	
260 mm	60	1	8501-260-60SW	
300 mm	60	1	8501-30SW	
305 mm	40	1	8501-305-30-40SW	
305 mm	60	1	8501-305-30-60SW	

Cirkelsågklinga för bordscirkelsågar, för sågning i trä



8501-S

300 mm	30	1	8501-30	
300 mm	40	1	8501-30F	
300 mm	60	1	8501-30XF	
315 mm	30	1	8501-31	
315 mm	40	1	8501-31F	
400 mm	40	1	8501-40	



Cirkelsågklinga för kapsåg för sågning i aluminium och plast



8501-AP

Ø	h	Material	QTY	Part No.
210 mm	48	Aluminum	1	8501-17S
216 mm	48	Aluminum	1	8501-18S
250 mm	80	Aluminum	1	8501-28S
260 mm	80	Aluminum	1	8501-260-30-80S
300 mm	96	Aluminum	1	8501-30S
305 mm	96	Aluminum	1	8501-305-30-96S

SLIP- OCH KAPSKIVOR

Högkvalitativa kapskivor för alla typer av metall inklusive rostfritt stål



391-T41_IM

Ø	h	Material	QTY	Part No.
115x1.6 mm	50	Aluminum	50	3911-115-T41-IM
115x1.0 mm	50	Aluminum	50	3911-115T41-IM
125x1.6 mm	50	Aluminum	50	3911-125-T41-IM
180x2.0 mm	50	Aluminum	50	3911-180-T41-IM
230x2.5 mm	50	Aluminum	50	3911-230-T41-IM
115x1.0 mm	50	Stainless Steel	50	3912-115-T41-IM
125x1.0 mm	50	Stainless Steel	50	3912-125-T41-IM
125x1.0 mm	25	Stainless Steel	25	3911-125T41-IM
180x1.6 mm	50	Stainless Steel	50	3911-180T41-IM
230x1.9 mm	50	Stainless Steel	50	3911-230T41-IM
230x3.0 mm	50	Stainless Steel	50	3911-230T41-IM
115x1 mm	10	Aluminum	10	3911-115-IM-10P
125x1 mm	10	Aluminum	10	3911-125-IM-10P

Kapskivor med hög prestanda för aluminium



391-T41_ALU

Ø	h	Material	QTY	Part No.
115 mm	22,23 mm	Aluminum	25	3911-115-T41-AL
125 mm	22,23 mm	Aluminum	25	3911-125-T41-AL

Högkvalitativa kapskivor för rostfritt stål



391-T41-I

Ø	h	Material	QTY	Part No.
115x1.0 mm	25	Stainless Steel	25	3911-115-T41-I
125x1.0 mm	25	Stainless Steel	25	3911-125-T41-I
150x1.0 mm	50	Stainless Steel	50	3911-150-T41-I
180x1.6 mm	50	Stainless Steel	50	3911-180-T41-I
230x1.9 mm	50	Stainless Steel	50	3911-230-T41-I

Kapskivor med hög prestanda för rostfritt stål och metall



391-T41_CS

Ø	h	Material	QTY	Part No.
356 mm	25,4 mm	Stainless Steel	35	3911-350-X2TM
400 mm	25,4 mm	Stainless Steel	15	3911-400-F2TM
400 mm	25,4 mm	Stainless Steel	15	3911-400-X2TM

Högkvalitativa kapskivor för metall



391-T42_M

Ø	h	Material	QTY	Part No.
115x2.5 mm	25	Aluminum	25	3911-115-T42-M
125x2.5 mm	25	Aluminum	25	3911-125-T42-M
150x2.5 mm	25	Aluminum	25	3911-150-T42-M
180x3.2 mm	25	Aluminum	25	3911-180-T42-M
230x3.2 mm	50	Aluminum	50	3911-230-T42-M

Högkvalitativa kapskivor för byggmaterial och sten



391-T42_ST

Ø	h	Material	QTY	Part No.
115x3.2 mm	25	Building Material	25	3912-115-T42-ST
125x3.2 mm	25	Building Material	25	3912-125-T42-ST
180x3.2 mm	25	Building Material	25	3912-180-T42-ST
230x3.2 mm	50	Building Material	50	3912-230-T42-ST

Högkvalitativa slipskivor för rostfritt stål och metall



392-T27_IM

Ø	h	Material	QTY	Part No.
115x6.4 mm	25	Aluminum	25	3921-115-T27-IM
125x6.4 mm	25	Aluminum	25	3921-125-T27-IM
150x6.4 mm	25	Aluminum	25	3921-150-T27-IM
180x6.5 mm	25	Aluminum	25	3921-180-T27-IM
230x6.5 mm	25	Aluminum	25	3921-230-T27-IM

Lamellrondell, konisk, för rostfritt stål och metall



392-FLAP_C

Ø	Material	Antal	Modell
115 mm	20	3926-115IM-C40	
115 mm	20	3926-115IM-C60	
115 mm	20	3926-115IM-C80	
115 mm	20	3926-115IM-C120	
125 mm	20	3926-125IM-C40	
125 mm	20	3926-125IM-C60	
125 mm	20	3926-125IM-C80	
125 mm	20	3926-125IM-C120	

Lamellrondell för rostfritt stål och metall



392-FLAP_P

Ø	Material	Antal	Modell
115 mm	20	3927-115IM-P40	
115 mm	20	3927-115IM-P60	
115 mm	20	3927-115IM-P80	
115 mm	20	3927-115IM-P120	
125 mm	20	3927-125IM-P40	
125 mm	20	3927-125IM-P60	
125 mm	20	3927-125IM-P80	
125 mm	20	3927-125IM-P120	
125 mm	12	3927-125-40-3P	
125 mm	12	3927-125-60-3P	
125 mm	12	3927-125-80-3P	
125 mm	12	3927-125-120-3P	

Diamantskivor för keramiska material och kakel



391-DIAM_C

Ø	Material	Antal	Modell
115 mm	100	3916-115-10P-CE	
125 mm	100	3916-125-10P-CE	
115 mm	100	3917-115-7S-C	
125 mm	100	3917-125-7S-C	

Diamantskivor för allroundkapning i sten



391-DIAM_U

Ø	Material	Antal	Modell
115 mm	100	3916-115-10S-UE	
125 mm	100	3916-125-10S-UE	
150 mm	50	3916-150-10S-UE	
180 mm	50	3916-180-10S-UE	
230 mm	25	3916-230-10S-UE	
115 mm	100	3917-115-7S-U	
125 mm	100	3917-125-7S-U	
230 mm	25	3917-230-7S-U	

Diamantskivor för armerad betong



391-DIAM_RC

Ø	Material	Antal	Modell
230 mm	25	3916-230-10L-RC	

BANDSÅGBLAD

Easy-Cut bandsågblad med Portaband



3857 Easy-Cut Portaband

Material	Antal	Modell
S EZ	1	3857-13-0.6-EZ-S-3P690
S EZ	1	3857-13-0.6-EZ-S-3P730
S EZ	1	3857-13-0.6-EZ-S-3P835
S EZ	1	3857-13-0.6-EZ-S-3P900
S EZ	1	3857-13-0.6-EZ-S-3P1140



ROTERANDE HÅRDMETALLFILAR

Cylindrisk roterande fil av hårdmetall, för metall



A

Ø	Wavy	Icons	Part No.
3 mm	Medium		1 A0313M03
3 mm	Medium		1 A0313M03E
3 mm	Medium		1 A0313M03X
3 mm	Medium		1 A0313M03XE
3 mm	Medium		1 A0313M03XE-60
3 mm	Medium		1 A0313M03XE-80
6.3 mm	Medium		1 A0613M03X
6 mm	Medium		1 A0616M06
6 mm	Medium		1 A0616M06E
6 mm	Medium		1 A0616M06X
6 mm	Medium		1 A0616M06XE
8 mm	Medium		1 A0820M06
8 mm	Medium		1 A0820M06E
8 mm	Medium		1 A0820M06X
8 mm	Medium		1 A0820M06XE
10 mm	Medium		1 A1020M06
10 mm	Medium		1 A1020M06E
9.6 mm	Medium		1 A1020M06X
9.6 mm	Medium		1 A1020M06XE
12 mm	Medium		1 A1225M06
12.7 mm	Medium		1 A1225M06E
12 mm	Medium		1 A1225M06X
12.7 mm	Medium		1 A1225M08
12.7 mm	Medium		1 A1225M08E
12.7 mm	Medium		1 A1225M08X
12.7 mm	Medium		1 A1225M08XE
16 mm	Medium		1 A1625M06
16 mm	Medium		1 A1625M06X
16 mm	Medium		1 A1625M06XE
16 mm	Medium		1 A1625M08
16 mm	Medium		1 A1625M08E
16 mm	Medium		1 A1625M08X
16 mm	Medium		1 A1625M08XE

Roterande fil av hårdmetall med cylindrisk form och rundad topp, för metall



C

Ø	Wavy	Icons	Part No.
3 mm	Medium		1 C0313M03
3 mm	Medium		1 C0313M03X
6.3 mm	Medium		1 C0616M03X
6 mm	Medium		1 C0616M06
6 mm	Medium		1 C0616M06X
8 mm	Medium		1 C0820M06
8 mm	Medium		1 C0820M06X

Ø	Wavy	Icons	Part No.
9.6 mm	Medium		1 C1020M06
10 mm	Medium		1 C1020M06X
12 mm	Medium		1 C1225M06
12 mm	Medium		1 C1225M06X
12.7 mm	Medium		1 C1225M08X
16 mm	Medium		1 C1625M06
16 mm	Medium		1 C1625M06X
16 mm	Medium		1 C1625M08
16 mm	Medium		1 C1625M08X

Roterande fil med kulform i hårdmetall, för metall



D

Ø	Wavy	Icons	Part No.
3 mm	Medium		1 D0303M03
3 mm	Medium		1 D0303M03X
6.3 mm	Medium		1 D0605M03X
6 mm	Medium		1 D0606M06
6 mm	Medium		1 D0606M06X
8 mm	Medium		1 D0807M06
8 mm	Medium		1 D0807M06X
9.6 mm	Medium		1 D1009M06
9.6 mm	Medium		1 D1009M06X
12.7 mm	Medium		1 D1211M06
12.7 mm	Medium		1 D1211M06X
16 mm	Medium		1 D1614M06
16 mm	Medium		1 D1614M06X
16 mm	Medium		1 D1614M08
16 mm	Medium		1 D1614M08X

Oval roterande fil i hårdmetall, för metall



E

Ø	Wavy	Icons	Part No.
3 mm	Medium		1 E0308M03
3 mm	Medium		1 E0308M03X
6 mm	Medium		1 E0614M06
8 mm	Medium		1 E0816M06
8 mm	Medium		1 E0816M06X
9.6 mm	Medium		1 E1018M06
9.6 mm	Medium		1 E1018M06X
12.7 mm	Medium		1 E1222M06
12.7 mm	Medium		1 E1222M06X
12.7 mm	Medium		1 E1222M08
12.7 mm	Medium		1 E1222M08X
16 mm	Medium		1 E1625M06

Ø	Wavy	Icons	Part No.
16 mm	Medium		1 E1625M06X
16 mm	Medium		1 E1625M08
16 mm	Medium		1 E1625M08X

Roterande fil av hårdmetall med spetsad form och rundad topp, för metall



F

Ø	Wavy	Icons	Part No.
3 mm	Medium		1 F0313M03
3 mm	Medium		1 F0313M03X
6.3 mm	Medium		1 F0613M03X
6 mm	Medium		1 F0618M06
6 mm	Medium		1 F0618M06X
8 mm	Medium		1 F0820M06
8 mm	Medium		1 F0820M06X
9.6 mm	Medium		1 F1020M06
9.6 mm	Medium		1 F1020M06X
12.7 mm	Medium		1 F1225M06
12.7 mm	Medium		1 F1225M06X
12.7 mm	Medium		1 F1225M08
12.7 mm	Medium		1 F1225M08X
16 mm	Medium		1 F1625M06
16 mm	Medium		1 F1625M06X
16 mm	Medium		1 F1625M08

Roterande fil med spetsad form i hårdmetall, för metall



G

Ø	Wavy	Icons	Part No.
3 mm	Medium		1 G0313M03
3 mm	Medium		1 G0313M03X
6.3 mm	Medium		1 G0613M03X
6 mm	Medium		1 G0618M06
6 mm	Medium		1 G0618M06X
8 mm	Medium		1 G0820M06
8 mm	Medium		1 G0820M06X
9.6 mm	Medium		1 G1020M06
9.6 mm	Medium		1 G1020M06X
12.7 mm	Medium		1 G1225M06
12.7 mm	Medium		1 G1225M06X
12 mm	Medium		1 G1225M08
12 mm	Medium		1 G1225M08X
16 mm	Medium		1 G1625M06
16 mm	Medium		1 G1625M06X
16 mm	Medium		1 G1625M08
16 mm	Medium		1 G1625M08X

Roterande fil med flamform i hårdmetall, för metall



H

6 mm	Medium	1	H0613M03X	
10 mm	Medium	1	H1025M06	
10 mm	Medium	1	H1025M06X	
12.7 mm	Medium	1	H1232M06	
12.7 mm	Medium	1	H1232M06X	
16 mm	Medium	1	H1635M06X	
16 mm	Medium	1	H1635M06	
16 mm	Medium	1	H1635M08	
16 mm	Medium	1	H1635M08X	

60° konisk roterande fil av hårdmetall, för metall



J

6 mm	Medium	1	J0604M06	
9.6 mm	Medium	1	J1010M06	
12.7 mm	Medium	1	J1212M06	
16 mm	Medium	1	J1616M06	
16 mm	Medium	1	J1616M08	

90° konisk roterande fil av hårdmetall, för metall



K

6 mm	Medium	1	K0602M06	
9.6 mm	Medium	1	K1008M06	
12.7 mm	Medium	1	K1210M06	
16 mm	Medium	1	K1612M06	
16 mm	Medium	1	K1612M08	

Roterande fil av hårdmetall med konisk form och rundad topp, för metall



L

10 mm	Medium	1	L1020M06	
10 mm	Medium	1	L1020M06X	
12.7 mm	Medium	1	L1225M06	
12.7 mm	Medium	1	L1225M06X	
12.7 mm	Medium	1	L1230M06	
12.7 mm	Medium	1	L1230M06X	
16 mm	Medium	1	L1630M06	
16 mm	Medium	1	L1630M06X	
16 mm	Medium	1	L1630M08	
16 mm	Medium	1	L1630M08X	

Roterande fil av hårdmetall med konisk form och spetsad topp, för metall



M

3 mm	Medium	1	M0310M03	
3 mm	Medium	1	M0310M03X	
6.3 mm	Medium	1	M0613M03X	
6 mm	Medium	1	M0618M06	
6 mm	Medium	1	M0618M06X	
9.5 mm	Medium	1	M1022M06	
9.5 mm	Medium	1	M1022M06X	
12.7 mm	Medium	1	M1227M06	
12.7 mm	Medium	1	M1227M06X	
12.7 mm	Medium	1	M1227M08	
16 mm	Medium	1	M1630M06	
16 mm	Medium	1	M1630M06X	
16 mm	Medium	1	M1630M08	
16 mm	Medium	1	M1630M08X	

Roterande fil av hårdmetall med omvänd konisk form, för metall



N

3 mm	Medium	1	N0306M03	
3 mm	Medium	1	N0306M03E	
6 mm	Medium	1	N0607M06	
12.7 mm	Medium	1	N1213M06	
12.7 mm	Medium	1	N1213M06X	
16 mm	Medium	1	N1613M06	
16 mm	Medium	1	N1613M06X	
16 mm	Medium	1	N1613M08	

Roterande fil av hårdmetall med rund topp, för aluminium



A-AL

6 mm	AL	1	A0616AL06E	
12.7 mm	AL	1	A1225AL06E	
12.7 mm	AL	1	A1225AL08E	
16 mm	AL	1	A1625AL08XE	

Roterande fil av hårdmetall med cylindrisk form och rundad topp, för aluminium



C-AL

6 mm	AL	1	C0616AL06	
12.7 mm	AL	1	C1225AL06	



Roterande fil av hårdmetall med kulform, för aluminium



D-AL

12.7 mm	AL	1	D1211AL06
12.7 mm	AL	1	D1211AL08

Cylindrisk roterande specialfil av hårdmetall för däckreparation



A/G

6 mm	TR	1	A0625M06X

Roterande fil med kulform i hårdmetall, för höglegerat stål



D-S

6 mm	Steel	5	D0606S06
9.6 mm	Steel	5	D1010S06
12.7 mm	Steel	5	D1212S06

Roterande fil av hårdmetall med spetsad form och rundad topp, för aluminium



F-AL

6 mm	AL	1	F0618AL06
12.7 mm	AL	1	F1225AL06
12.7 mm	AL	1	F1225AL08

Cylindrisk roterande fil av hårdmetall, för höglegerat stål



A-S

6 mm	Steel	5	A0618S06E
9.6 mm	Steel	5	A1020S06
9.6 mm	Steel	5	A1020S06E
12.7 mm	Steel	5	A1225S06
12.7 mm	Steel	5	A1225S06E

Roterande fil med spetsad form och rundad topp, i hårdmetall, för höglegerat stål



F-S

6 mm	Steel	5	F0618S06
9.6 mm	Steel	5	F1020S06
12.7 mm	Steel	5	F1225S06

Roterande fil av hårdmetall med konisk form och rundad topp, för aluminium



L-AL

12.7 mm	AL	1	L1230AL06
12.7 mm	AL	1	L1230AL08

Roterande fil med cylindrisk form och rundad topp i hårdmetall, för höglegerat stål



C-S

6 mm	Steel	5	C0618S06
9.6 mm	Steel	5	C1020S06
12.7 mm	Steel	5	C1225S06

Roterande fil med spetsad form i hårdmetall, för höglegerat stål



G-S

9.6 mm	Steel	5	G1020S06
12.7 mm	Steel	5	G1225S06

Roterande fil med konisk form och rundad topp, i hårdmetall, för höglegerat stål



L-S

Ø	Material	5	Part Number
9.6 mm	Steel	5	L1020S06
12.7 mm	Steel	5	L1228S06

Roterande fil med kulform i hårdmetall, för rostfritt stål



D-I

Ø	Material	5	Part Number
3 mm	Inox	5	D0303I03
6 mm	Inox	5	D0606I06
9.6 mm	Inox	5	D1010I06
12.7 mm	Inox	5	D1212I06

Roterande fil med spetsad form i hårdmetall, för rostfritt stål



G-I

Ø	Material	5	Part Number
9.6 mm	Inox	5	G1020I06
12.7 mm	Inox	5	G1225I06

Roterande fil med cylindrisk form, i hårdmetall, för rostfritt stål



A-I

Ø	Material	5	Part Number
3 mm	Inox	5	A0314I03
6 mm	Inox	5	A0618I06
9.6 mm	Inox	5	A1020I06
12.7 mm	Inox	5	A1225I06

Roterande fil med oval form i hårdmetall, för rostfritt stål



E-I

Ø	Material	5	Part Number
9.6 mm	Inox	5	E1015I06
12.7 mm	Inox	5	E1220I06

Roterande fil med flamform i hårdmetall, för rostfritt stål



H-I

Ø	Material	5	Part Number
9.6 mm	Inox	5	H1020I06
12.7 mm	Inox	5	H1232I06

Roterande fil med cylindrisk form och rundad topp, i hårdmetall, för rostfritt stål



C-I

Ø	Material	5	Part Number
3 mm	Inox	5	C0312I03
6 mm	Inox	5	C0618I06
9.6 mm	Inox	5	C1020I06
12.7 mm	Inox	5	C1225I06

Roterande fil med spetsad form och rundad topp i hårdmetall, för rostfritt stål



F-I

Ø	Material	5	Part Number
3 mm	Inox	5	F0312I03
6 mm	Inox	5	F0618I06
9.6 mm	Inox	5	F1020I06
12.7 mm	Inox	5	F1225I06

Roterande fil med konisk form och rundad topp i hårdmetall, för rostfritt stål



L-I

Ø	Material	5	Part Number
9.6 mm	Inox	5	L1020I06
12.7 mm	Inox	5	L1228I06



Roterande fil med spetsad form i hårdmetall, för däckreparation



TR

3 mm	Tire Repair	5	TR0325M03X-50
4.5 mm	Tire Repair	5	TR0636M06X-65
6 mm	Tire Repair	5	TR0650M06X-80
8 in	Tire Repair	5	TR0860M08X-110
8 mm	Tire Repair	5	TR4.530M06X-90

Roterande fil av hårdmetall, sats för metall, 10 och 12 mm – 5 st.



ST-1-5P

5	376 g	1	RB-SET1-M06X-5P

A1020M06XE	
C1225M06X	
F1225M06X	
G1020M06X	
L1230M06X	

Roterande fil av hårdmetall, sats för metall, 10 mm – 5 st.



ST-2-5P

5	313 g	1	RB-SET2-M06X-5P

A1020M06XE	
C1020M06X	
D1009M06X	
F1020M06X	
L1020M06X	

Roterande fil av hårdmetall, sats för metall – 10 st.



ST-10P

10	542 g	1	RB-SET-M06X-10P

A1020M06XE, A1225M06X	
C1020M06X, C1225M06X	
D1211M06X	
E1018M06X	
F1225M06X	
G1020M06X, G1225M06X	
L1230M06X	

Roterande fil av hårdmetall, sats för aluminium – 5 st.



ALU-5P

5	380 g	1	RB-SET-AL06-5P

A1225AL06E	
C1225AL06	
D1211AL06	
F1225AL06	
L1230AL06	

BORRAR

Fyreggad SDS Max-borr för armerad betong



4656

12.0 mm	340 mm	1	4656-12-340
12.0 mm	540 mm	1	4656-12-540
14.0 mm	340 mm	1	4656-14-340
14.0 mm	540 mm	1	4656-14-540
15.0 mm	340 mm	1	4656-15-340
16.0 mm	340 mm	1	4656-16-340
16.0 mm	540 mm	1	4656-16-540
16.0 mm	940 mm	1	4656-16-940
16.0 mm	1320 mm	1	4656-16-1320
18.0 mm	340 mm	1	4656-18-340
18.0 mm	540 mm	1	4656-18-540
18.0 mm	940 mm	1	4656-18-940
18.0 mm	1320 mm	1	4656-18-1320
20.0 mm	320 mm	1	4656-20-320
20.0 mm	520 mm	1	4656-20-520
20.0 mm	920 mm	1	4656-20-920
20.0 mm	1320 mm	1	4656-20-1320
22.0 mm	320 mm	1	4656-22-320
22.0 mm	520 mm	1	4656-22-520
22.0 mm	920 mm	1	4656-22-920
22.0 mm	1320 mm	1	4656-22-1320
24.0 mm	320 mm	1	4656-24-320
24.0 mm	520 mm	1	4656-24-520
25.0 mm	320 mm	1	4656-25-320
25.0 mm	520 mm	1	4656-25-520
25.0 mm	920 mm	1	4656-25-920
25.0 mm	1320 mm	1	4656-25-1320
26.0 mm	520 mm	1	4656-26-520
28.0 mm	370 mm	1	4656-28-370
28.0 mm	570 mm	1	4656-28-570
28.0 mm	670 mm	1	4656-28-670
28.0 mm	920 mm	1	4656-28-920
30.0 mm	370 mm	1	4656-30-370
30.0 mm	570 mm	1	4656-30-570
32.0 mm	370 mm	1	4656-32-370
32.0 mm	570 mm	1	4656-32-570
32.0 mm	920 mm	1	4656-32-920
32.0 mm	1320 mm	1	4656-32-1320
35.0 mm	370 mm	1	4656-35-370
35.0 mm	570 mm	1	4656-35-570
35.0 mm	670 mm	1	4656-35-670
37.0 mm	370 mm	1	4656-37-370
37.0 mm	570 mm	1	4656-37-570
37.0 mm	920 mm	1	4656-37-920
38.0 mm	370 mm	1	4656-38-370
38.0 mm	570 mm	1	4656-38-570
40.0 mm	370 mm	1	4656-40-370
40.0 mm	570 mm	1	4656-40-570
40.0 mm	920 mm	1	4656-40-920
40.0 mm	1320 mm	1	4656-40-1320
45.0 mm	570 mm	1	4656-45-570
45.0 mm	920 mm	1	4656-45-920
50.0 mm	570 mm	1	4656-50-570
52.0 mm	570 mm	1	4656-52-570

Fyreggad SDS Plus-borr för armerad betong



4651



Ø	L		
---	---	--	--

5.0 mm	115 mm	1	4651-5-110
5.0 mm	110 mm	1	4651-5-110-10P
5.0 mm	165 mm	1	4651-5-160
5.0 mm	160 mm	1	4651-5-160-10P
5.0 mm	265 mm	1	4651-5-260
5.5 mm	110 mm	10	4651-5,5-110-10P
5.5 mm	160 mm	1	4651-5,5-160-10P
5.5 mm	115 mm	1	4651-5,5-110
5.5 mm	165 mm	1	4651-5,5-160
6.0 mm	115 mm	1	4651-6-110
6.0 mm	110 mm	1	4651-6-110-10P
6.0 mm	165 mm	1	4651-6-160
6.0 mm	160 mm	1	4651-6-160-10P
6.0 mm	215 mm	1	4651-6-210
6.0 mm	265 mm	1	4651-6-260
6.0 mm	315 mm	1	4651-6-310
6.5 mm	110 mm	50	4651-6,5-110
6.5 mm	165 mm	1	4651-6,5-160
6.5 mm	160 mm	1	4651-6,5-160-10P
6.5 mm	215 mm	1	4651-6,5-210
6.5 mm	265 mm	1	4651-6,5-260
6.5 mm	315 mm	1	4651-6,5-310
7.0 mm	115 mm	1	4651-7-110
7.0 mm	165 mm	1	4651-7-160
8.0 mm	115 mm	1	4651-8-110
8.0 mm	165 mm	1	4651-8-160
8.0 mm	160 mm	1	4651-8-160-10P
8.0 mm	215 mm	1	4651-8-210
8.0 mm	210 mm	1	4651-8-210-10P
8.0 mm	265 mm	1	4651-8-260
8.0 mm	315 mm	1	4651-8-310
8.0 mm	465 mm	1	4651-8-460
10.0 mm	115 mm	1	4651-10-110
10.0 mm	165 mm	1	4651-10-160
10.0 mm	160 mm	1	4651-10-160-10P
10.0 mm	215 mm	1	4651-10-210
10.0 mm	210 mm	1	4651-10-210-10P
10.0 mm	265 mm	1	4651-10-260
10.0 mm	315 mm	1	4651-10-310
10.0 mm	455 mm	1	4651-10-450
10.0 mm	600 mm	1	4651-10-600
10.0 mm	1000 mm	1	4651-10-1000
12.0 mm	160 mm	1	4651-12-160
12.0 mm	160 mm	1	4651-12-160-10P
12.0 mm	210 mm	1	4651-12-210
12.0 mm	210 mm	1	4651-12-210-10P
12.0 mm	260 mm	1	4651-12-260
12.0 mm	310 mm	1	4651-12-310
12.0 mm	450 mm	1	4651-12-450
12.0 mm	600 mm	1	4651-12-600
12.0 mm	1000 mm	1	4651-12-1000
14.0 mm	160 mm	1	4651-14-160
14.0 mm	210 mm	1	4651-14-210
14.0 mm	260 mm	1	4651-14-260
14.0 mm	310 mm	1	4651-14-310
14.0 mm	450 mm	1	4651-14-450
14.0 mm	600 mm	1	4651-14-600
14.0 mm	1000 mm	1	4651-14-1000
15.0 mm	160 mm	1	4651-15-160
15.0 mm	260 mm	1	4651-15-260
15.0 mm	450 mm	1	4651-15-450
16.0 mm	160 mm	1	4651-16-160
16.0 mm	210 mm	1	4651-16-210
16.0 mm	260 mm	1	4651-16-260
16.0 mm	310 mm	1	4651-16-310
16.0 mm	450 mm	1	4651-16-450
16.0 mm	600 mm	1	4651-16-600
16.0 mm	1000 mm	1	4651-16-1000

Ø	L		
18.0 mm	250 mm	1	4651-18-250
18.0 mm	450 mm	1	4651-18-450
20.0 mm	250 mm	1	4651-20-250
20.0 mm	450 mm	1	4651-20-450
22.0 mm	250 mm	1	4651-22-250
22.0 mm	450 mm	1	4651-22-450
24.0 mm	250 mm	1	4651-24-250
24.0 mm	450 mm	1	4651-24-450
25.0 mm	250 mm	1	4651-25-250
25.0 mm	450 mm	1	4651-25-450
28.0 mm	250 mm	1	4651-28-250
28.0 mm	450 mm	1	4651-28-450
30.0 mm	250 mm	1	4651-30-250
30.0 mm	450 mm	1	4651-30-450
32.0 mm	450 mm	1	4651-32-450

Tvåeggad SDS Plus-borr för betong



4652



Ø	L		
---	---	--	--

3.0 mm	110 mm	50	4652-3-110
3.5 mm	110 mm	50	4652-3,5-110
4.0 mm	110 mm	1	4652-4-110
4.0 mm	160 mm	1	4652-4-160
5.0 mm	110 mm	1	4652-5-110
5.0 mm	160 mm	1	4652-5-160
5.0 mm	110 mm	1	4652-5-110-10P
5.0 mm	160 mm	1	4652-5-160-10P
5.0 mm	210 mm	1	4652-5-210
5.5 mm	110 mm	1	4652-5,5-110
5.5 mm	110 mm	10	4652-5,5-110-10P
5.5 mm	160 mm	1	4652-5,5-160
5.5 mm	160 mm	1	4652-5,5-160-10P
5.5 mm	210 mm	50	4652-5,5-210
6.0 mm	110 mm	1	4652-6-110
6.0 mm	110 mm	1	4652-6-110-10P
6.0 mm	160 mm	50	4652-6-160
6.0 mm	160 mm	1	4652-6-160-10P
6.0 mm	210 mm	1	4652-6-210
6.0 mm	260 mm	1	4652-6-260
6.5 mm	110 mm	1	4652-6,5-110
6.5 mm	160 mm	1	4652-6,5-160
6.5 mm	160 mm	1	4652-6,5-160-10P
7.0 mm	110 mm	1	4652-7-110
7.0 mm	160 mm	1	4652-7-160
8.0 mm	110 mm	1	4652-8-110
8.0 mm	160 mm	1	4652-8-160
8.0 mm	160 mm	1	4652-8-160-10P
8.0 mm	210 mm	1	4652-8-210
8.0 mm	210 mm	1	4652-8-210-10P
8.0 mm	260 mm	1	4652-8-260
8.0 mm	460 mm	1	4652-8-460
9.0 mm	160 mm	1	4652-9-160
9.0 mm	210 mm	1	4652-9-210
10.0 mm	110 mm	1	4652-10-110
10.0 mm	160 mm	1	4652-10-160
10.0 mm	160 mm	1	4652-10-160-10P
10.0 mm	210 mm	1	4652-10-210
10.0 mm	210 mm	1	4652-10-210-10P
10.0 mm	260 mm	1	4652-10-260
10.0 mm	310 mm	1	4652-10-310
10.0 mm	450 mm	1	4652-10-450
10.0 mm	600 mm	1	4652-10-600
11.0 mm	160 mm	1	4652-11-160
11.0 mm	260 mm	1	4652-11-260
12.0 mm	160 mm	1	4652-12-160
12.0 mm	160 mm	1	4652-12-160-10P
12.0 mm	210 mm	1	4652-12-210
12.0 mm	210 mm	1	4652-12-210-10P
12.0 mm	260 mm	1	4652-12-260
12.0 mm	310 mm	1	4652-12-310
12.0 mm	450 mm	1	4652-12-450
12.0 mm	600 mm	1	4652-12-600
12.0 mm	1000 mm	1	4652-12-1000

Borrsats för armerad betong SDS + 4C – 5 delar



4651-SET-5



Ø	L		
---	---	--	--

5		1	4651-SET-5
---	--	---	------------

4651-5-110, 4651-6-110, 4651-6-160, 4651-8-160, 4651-10-160

Borrsats för armerad betong SDS + 4C – 7 delar



4651-SET-7



Ø	L		
---	---	--	--

7		1	4651-SET-7
---	--	---	------------

4651-5-110, 4651-6-110, 4651-8-110, 4651-6-160, 4651-8-160, 4651-10-160, 4651-12-160



Ø	L		
13.0 mm	310 mm	1	4652-13-310
14.0 mm	160 mm	1	4652-14-160
14.0 mm	210 mm	1	4652-14-210
14.0 mm	260 mm	1	4652-14-260
14.0 mm	310 mm	1	4652-14-310
14.0 mm	450 mm	1	4652-14-450
14.0 mm	600 mm	1	4652-14-600
14.0 mm	1000 mm	1	4652-14-1000
15.0 mm	260 mm	1	4652-15-260
16.0 mm	210 mm	1	4652-16-210
16.0 mm	260 mm	1	4652-16-260
16.0 mm	310 mm	1	4652-16-310
16.0 mm	450 mm	1	4652-16-450
16.0 mm	600 mm	1	4652-16-600
16.0 mm	1000 mm	1	4652-16-1000
18.0 mm	200 mm	1	4652-18-200
18.0 mm	300 mm	1	4652-18-300
18.0 mm	450 mm	1	4652-18-450
18.0 mm	1000 mm	1	4652-18-1000
20.0 mm	200 mm	1	4652-20-200
20.0 mm	300 mm	1	4652-20-300
20.0 mm	450 mm	1	4652-20-450
20.0 mm	600 mm	1	4652-20-600
20.0 mm	1000 mm	1	4652-20-1000
22.0 mm	250 mm	1	4652-22-250
22.0 mm	450 mm	1	4652-22-450
22.0 mm	600 mm	1	4652-22-600
22.0 mm	1000 mm	1	4652-22-1000
24.0 mm	250 mm	1	4652-24-250
24.0 mm	450 mm	1	4652-24-450
25.0 mm	250 mm	1	4652-25-250
25.0 mm	450 mm	1	4652-25-450
25.0 mm	1000 mm	1	4652-25-1000
26.0 mm	250 mm	1	4652-26-250
26.0 mm	450 mm	1	4652-26-450

Borrsats för armerad betong SDS + 2C – 7 delar



4652-SET-7

X		
7	1	4652-SET-7

4652-5-110, 4652-6-110, 4652-8-110,
4652-6-160, 4652-8-160, 4652-10-160,
4652-12-160

Betongbör med hårdmetallspets



Borrsats för armerad betong SDS + 2C – 5 delar



4652-SET-5

X		
5	1	4652-SET-5

4652-5-110, 4652-6-110, 4652-6-160,
4652-8-160, 4652-10-160

4641

Ø	L		
3.0 mm	60 mm	1	4641-3-60
4.0 mm	75 mm	1	4641-4-75
5.0 mm	85 mm	1	4641-5-85
5.0 mm	150 mm	1	4641-5-150
5.5 mm	85 mm	1	4641-5.5-85
6.0 mm	100 mm	1	4641-6-100
6.0 mm	150 mm	1	4641-6-150
6.0 mm	400 mm	1	4641-6-400
6.5 mm	100 mm	1	4641-6.5-100
7.0 mm	100 mm	1	4641-7-100
8.0 mm	120 mm	1	4641-8-120
8.0 mm	200 mm	1	4641-8-200
8.0 mm	400 mm	1	4641-8-400
9.0 mm	120 mm	1	4641-9-120
10.0 mm	120 mm	1	4641-10-120
10.0 mm	200 mm	1	4641-10-200
10.0 mm	400 mm	1	4641-10-400
10.0 mm	600 mm	1	4641-10-600
11.0 mm	150 mm	1	4641-11-150
12.0 mm	150 mm	1	4641-12-150
12.0 mm	200 mm	1	4641-12-200
12.0 mm	400 mm	1	4641-12-400
12.0 mm	600 mm	1	4641-12-600
13.0 mm	150 mm	1	4641-13-150
14.0 mm	150 mm	1	4641-14-150
14.0 mm	400 mm	1	4641-14-400
14.0 mm	600 mm	1	4641-14-600
16.0 mm	150 mm	1	4641-16-150
16.0 mm	400 mm	1	4641-16-400

Ø	L		
16.0 mm	600 mm	1	4641-16-600
18.0 mm	400 mm	1	4641-18-400
18.0 mm	600 mm	1	4641-18-600
20.0 mm	400 mm	1	4641-20-400
20.0 mm	600 mm	1	4641-20-600
22.0 mm	400 mm	1	4641-22-400
24.0 mm	400 mm	1	4641-24-400
25.0 mm	400 mm	1	4641-25-400

Sats med betongborrar med hårdmetallspets – 5 st.



4641-PB

X	g	
5	185 g	1 4641-PB

4641-4-75, 4641-5-85, 4641-6-100, 4641-8-120,
4641-10-120

Installationsborrsats med hårdmetallspets – 5 delar



4643-PB

X	g	
5	150 g	1 4643-PB

4mm, 5mm, 6mm, 8mm and 10mm1pc x Ø 4, 5, 6, 8, 10 mm

SDS Max-mejsel för armerad betong



4659



Ø	L		
- mm	280 mm	1	4659-POINT-28
- mm	400 mm	1	4659-POINT-40
- mm	600 mm	1	4659-POINT-60
24.0 mm	280 mm	1	4659-FLAT-28
24.0 mm	400 mm	1	4659-FLAT-40
24.0 mm	600 mm	1	4659-FLAT-60
80.0 mm	300 mm	1	4659-WIDE-30-8
50.0 mm	360 mm	1	4659-WIDE-36-5
50.0 mm	300 mm	1	4659-TILE-30-5
80.0 mm	300 mm	1	4659-TILE-30-8

SDS Plus-mejsel för armerad betong



4655



Ø	L		
20.0 mm	250 mm	1	4655-FLAT-250
22.0 mm	240 mm	1	4655-HOLLOW-240
- mm	250 mm	1	4655-POINT-250
32.0 mm	200 mm	1	4655-SLOT-25032
38.0 mm	200 mm	1	4655-TILE-20040
38.0 mm	200 mm	1	4655-WIDE-20040
22.0 mm	250 mm	1	4655-WING-C-250

Borr i koboltsnabbstål (HSS-E) för metall



4411



Ø	L		
1.00 mm	34 mm	1	4411-1.00
1.50 mm	40 mm	1	4411-1.50
2.00 mm	49 mm	1	4411-2.00
2.50 mm	57 mm	1	4411-2.50
3.00 mm	61 mm	1	4411-3.00
3.25 mm	65 mm	1	4411-3.25
3.30 mm	65 mm	1	4411-3.30
3.50 mm	70 mm	1	4411-3.50
4.00 mm	75 mm	1	4411-4.00
4.20 mm	75 mm	1	4411-4.20
4.25 mm	75 mm	1	4411-4.25
4.50 mm	80 mm	1	4411-4.50
5.00 mm	86 mm	1	4411-5.00
5.50 mm	93 mm	1	4411-5.50
6.00 mm	93 mm	1	4411-6.00
6.50 mm	101 mm	1	4411-6.50

Ø	L		
6.80 mm	109 mm	1	4411-6.80
7.00 mm	109 mm	1	4411-7.00
7.50 mm	109 mm	1	4411-7.50
8.00 mm	117 mm	1	4411-8.00
8.50 mm	117 mm	1	4411-8.50
9.00 mm	125 mm	1	4411-9.00
9.50 mm	125 mm	1	4411-9.50
10.00 mm	125 mm	1	4411-10.00
10.20 mm	133 mm	1	4411-10.20
10.50 mm	133 mm	1	4411-10.50
11.00 mm	142 mm	1	4411-11.00
11.50 mm	142 mm	1	4411-11.50
12.00 mm	151 mm	1	4411-12.00
12.50 mm	151 mm	1	4411-12.50
13.00 mm	151 mm	1	4411-13.00

Size 1 mm up to 4 mm, two drills in each tube

Borrar i kobolt-snabbstål (HSS-E) för metall, i industripack



4511

Ø	L		
0.50 mm	22 mm	1	4511-0.50-10P
0.75 mm	28 mm	1	4511-0.75-10P
1.00 mm	34 mm	1	4511-1.00-10P
1.50 mm	40 mm	1	4511-1.50-10P
1.75 mm	46 mm	1	4511-1.75-10P
2.00 mm	49 mm	1	4511-2.00-10P
2.50 mm	57 mm	1	4511-2.50-10P
2.70 mm	61 mm	1	4511-2.70-10P
2.90 mm	61 mm	1	4511-2.90-10P
3.00 mm	61 mm	1	4511-3.00-10P
3.10 mm	65 mm	1	4511-3.10-10P
3.25 mm	65 mm	1	4511-3.25-10P
3.30 mm	65 mm	1	4511-3.30-10P
3.50 mm	70 mm	1	4511-3.50-10P
3.80 mm	75 mm	1	4511-3.80-10P
4.00 mm	75 mm	1	4511-4.00-10P
4.20 mm	75 mm	1	4511-4.20-10P
4.50 mm	80 mm	1	4511-4.50-10P
4.80 mm	86 mm	1	4511-4.80-10P
5.00 mm	86 mm	1	4511-5.00-10P
5.20 mm	86 mm	1	4511-5.20-10P
5.50 mm	93 mm	1	4511-5.50-10P
6.00 mm	93 mm	1	4511-6.00-10P
6.20 mm	101 mm	1	4511-6.20-10P
6.50 mm	101 mm	1	4511-6.50-10P
6.80 mm	109 mm	1	4511-6.80-10P
7.00 mm	109 mm	1	4511-7.00-10P
7.20 mm	109 mm	1	4511-7.20-10P
7.50 mm	109 mm	1	4511-7.50-10P
7.80 mm	117 mm	1	4511-7.80-10P
8.00 mm	117 mm	1	4511-8.00-10P
8.50 mm	117 mm	1	4511-8.50-10P
8.60 mm	125 mm	1	4511-8.60-10P
8.80 mm	125 mm	1	4511-8.80-10P
9.00 mm	125 mm	1	4511-9.00-10P
9.20 mm	125 mm	1	4511-9.20-10P
9.50 mm	125 mm	1	4511-9.50-10P
9.60 mm	133 mm	1	4511-9.60-10P
10.00 mm	133 mm	1	4511-10.00-5P
10.20 mm	133 mm	1	4511-10.20-5P
10.30 mm	133 mm	1	4511-10.30-5P
10.50 mm	133 mm	1	4511-10.50-5P
10.80 mm	142 mm	1	4511-10.80-5P
11.00 mm	142 mm	1	4511-11.00-5P
11.50 mm	142 mm	1	4511-11.50-5P
12.00 mm	151 mm	1	4511-12.00-5P
12.50 mm	151 mm	1	4511-12.50-5P
12.80 mm	151 mm	1	4511-12.80-5P

Ø	L		
13.00 mm	151 mm	1	4511-13.00-5P
13.50 mm	160 mm	1	4511-13.50-1P
14.00 mm	160 mm	1	4511-14.00-1P
14.50 mm	169 mm	1	4511-14.50-1P
15.00 mm	169 mm	1	4511-15.00-1P
15.50 mm	169 mm	1	4511-15.50-1P
16.00 mm	178 mm	1	4511-16.00-1P
16.50 mm	184 mm	1	4511-16.50-1P
17.00 mm	184 mm	1	4511-17.00-1P
17.50 mm	191 mm	1	4511-17.50-1P
18.00 mm	191 mm	1	4511-18.00-1P
18.50 mm	198 mm	1	4511-18.50-1P
19.00 mm	198 mm	1	4511-19.00-1P
19.50 mm	205 mm	1	4511-19.50-1P
20.00 mm	205 mm	1	4511-20.00-1P

Sats med borrar i koboltsnabbstål (HSS-E) för metall – 6 st.



4511-SET-6

X	g		
6	150 g	1	4511-SET-6

2,0 till 8,0 x 1,0 mm (exkl. 7,0 mm) i en plastkassett

4411-2.00, 4411-3.00, 4411-4.00, 4411-5.00, 4411-6.00, 4411-8.00

Sats med borrar i koboltsnabbstål (HSS-E) för metall – 19 st.



4511-SET-19

X	g		
19	600 g	1	4511-SET-19

1,0 mm till 10,0 x 0,5 mm i en plastlåda

4411-1.00, 4411-1.50, 4411-2.00, 4411-2.50, 4411-3.00, 4411-3.50, 4411-4.00, 4411-4.50, 4411-5.00, 4411-5.50, 4411-6.00, 4411-6.50, 4411-7.00, 4411-7.50, 4411-8.00, 4411-8.50, 4411-9.00, 4411-9.50, 4411-10.00



Sats med borrar i koboltsnabbstål (HSS-E) för metall – 25 st.



4511-SET-25

25	1200 g	1	4511-SET-25

1,0 mm till 13,0 mm x 0,5 mm i en plastlåda



HSS-G-borr för metall



4413

--	--	--	--

1.00 mm	34 mm	1	4413-1.00
1.50 mm	40 mm	1	4413-1.50
2.00 mm	49 mm	1	4413-2.00
2.50 mm	57 mm	1	4413-2.50
3.00 mm	61 mm	1	4413-3.00
3.25 mm	65 mm	1	4413-3.25
3.30 mm	65 mm	1	4413-3.30
3.50 mm	70 mm	1	4413-3.50
4.00 mm	75 mm	1	4413-4.00
4.20 mm	75 mm	1	4413-4.20
4.25 mm	75 mm	1	4413-4.25
4.50 mm	80 mm	1	4413-4.50
5.00 mm	86 mm	1	4413-5.00
5.50 mm	93 mm	1	4413-5.50
6.00 mm	93 mm	1	4413-6.00
6.50 mm	101 mm	1	4413-6.50
6.80 mm	109 mm	1	4413-6.80
7.00 mm	109 mm	1	4413-7.00
7.50 mm	109 mm	1	4413-7.50
8.00 mm	117 mm	1	4413-8.00
8.50 mm	117 mm	1	4413-8.50
9.00 mm	125 mm	1	4413-9.00
9.50 mm	125 mm	1	4413-9.50
10.00 mm	133 mm	1	4413-10.00
10.20 mm	133 mm	1	4413-10.20
10.50 mm	133 mm	25	4413-10.50
11.00 mm	142 mm	1	4413-11.00
11.50 mm	142 mm	25	4413-11.50
12.00 mm	151 mm	1	4413-12.00
12.50 mm	151 mm	25	4413-12.50
13.00 mm	151 mm	1	4413-13.00

Size 1 mm up to 4 mm, two drills in each tube

HSS-G-borrar för metall, industripack



4513

--	--	--	--

1.00 mm	34 mm	1	4513-1.00-10P
1.50 mm	40 mm	1	4513-1.50-10P
1.75 mm	46 mm	1	4513-1.75-10P
2.00 mm	49 mm	1	4513-2.00-10P
2.50 mm	57 mm	1	4513-2.50-10P
2.70 mm	61 mm	1	4513-2.70-10P
2.90 mm	61 mm	1	4513-2.90-10P
3.00 mm	61 mm	1	4513-3.00-10P
3.10 mm	65 mm	1	4513-3.10-10P
3.25 mm	65 mm	1	4513-3.25-10P
3.30 mm	65 mm	1	4513-3.30-10P
3.50 mm	70 mm	1	4513-3.50-10P
3.80 mm	75 mm	1	4513-3.80-10P
4.00 mm	75 mm	1	4513-4.00-10P
4.20 mm	75 mm	1	4513-4.20-10P
4.50 mm	80 mm	1	4513-4.50-10P
4.80 mm	86 mm	1	4513-4.80-10P
5.00 mm	86 mm	1	4513-5.00-10P
5.20 mm	86 mm	1	4513-5.20-10P
5.50 mm	93 mm	1	4513-5.50-10P
6.00 mm	93 mm	1	4513-6.00-10P
6.20 mm	101 mm	1	4513-6.20-10P
6.50 mm	101 mm	1	4513-6.50-10P
6.80 mm	109 mm	1	4513-6.80-10P
7.00 mm	109 mm	1	4513-7.00-10P
7.20 mm	109 mm	1	4513-7.20-10P
7.50 mm	109 mm	1	4513-7.50-10P
7.80 mm	117 mm	1	4513-7.80-10P
8.00 mm	117 mm	1	4513-8.00-10P
8.50 mm	117 mm	1	4513-8.50-10P
8.60 mm	125 mm	1	4513-8.60-10P
8.80 mm	125 mm	1	4513-8.80-10P
9.00 mm	125 mm	1	4513-9.00-10P
9.20 mm	125 mm	1	4513-9.20-10P
9.50 mm	125 mm	1	4513-9.50-10P
9.60 mm	133 mm	1	4513-9.60-10P
10.00 mm	133 mm	1	4513-10.00-5P
10.20 mm	133 mm	1	4513-10.20-5P
10.30 mm	133 mm	1	4513-10.30-5P
10.50 mm	133 mm	1	4513-10.50-5P
10.80 mm	142 mm	1	4513-10.80-5P
11.00 mm	142 mm	1	4513-11.00-5P
11.50 mm	142 mm	1	4513-11.50-5P
12.00 mm	151 mm	1	4513-12.00-5P
12.50 mm	151 mm	1	4513-12.50-5P
12.80 mm	151 mm	1	4513-12.80-5P
13.00 mm	151 mm	1	4513-13.00-5P
13.50 mm	160 mm	1	4513-13.50-1P
14.00 mm	160 mm	1	4513-14.00-1P
14.50 mm	169 mm	1	4513-14.50-1P
15.00 mm	169 mm	1	4513-15.00-1P
15.50 mm	178 mm	1	4513-15.50-1P
16.00 mm	178 mm	1	4513-16.00-1P
16.50 mm	184 mm	1	4513-16.50-1P
17.00 mm	184 mm	1	4513-17.00-1P
17.50 mm	191 mm	1	4513-17.50-1P
18.00 mm	191 mm	1	4513-18.00-1P

18.50 mm	198 mm	1	4513-18.50-1P
19.00 mm	198 mm	1	4513-19.00-1P
19.50 mm	205 mm	1	4513-19.50-1P
20.00 mm	205 mm	1	4513-20.00-1P

Sats med HSS-G-borrar för metall – 6 st.



4513-SET-6

6	150 g	1	4513-SET-6

2,0 mm till 8,0 x 1,0 mm (exkl. 7,0 mm) i en plastkassett

4413-2.00, 4413-3.00, 4413-4.00, 4413-5.00, 4413-6.00, 4413-8.00



Sats med HSS-G-borrar för metall – 19 st.



4513-SET-19

19	600 g	1	4513-SET-19

1.0 to 10.0 mm x 0.5 mm i plastlåda

4413-1.00, 4413-1.50, 4413-2.00, 4413-2.50, 4413-3.00, 4413-3.50, 4413-4.00, 4413-4.50, 4413-5.00, 4413-5.50, 4413-6.00, 4413-6.50, 4413-7.00, 4413-7.50, 4413-8.00, 4413-8.50, 4413-9.00, 4413-9.50, 4413-10.00



Sats med HSS-G-borrar för metall – 25 st.



4513-SET-25

25	1200 g	1	4513-SET-25

1,0 till 13,0 mm x 0,5 mm i plastlåda

HSS-R-borr för metall



4415

1.00 mm	34 mm	1	4415-1.00
1.50 mm	40 mm	1	4415-1.50
2.00 mm	49 mm	1	4415-2.00
2.50 mm	57 mm	1	4415-2.50
3.00 mm	61 mm	1	4415-3.00
3.25 mm	65 mm	1	4415-3.25
3.50 mm	70 mm	1	4415-3.50
4.00 mm	75 mm	1	4415-4.00
4.25 mm	75 mm	1	4415-4.25
4.50 mm	80 mm	1	4415-4.50
5.00 mm	86 mm	1	4415-5.00
5.50 mm	93 mm	1	4415-5.50
6.00 mm	93 mm	1	4415-6.00
6.50 mm	101 mm	1	4415-6.50
7.00 mm	109 mm	1	4415-7.00
7.50 mm	109 mm	1	4415-7.50
8.00 mm	117 mm	1	4415-8.00
8.50 mm	117 mm	1	4415-8.50
9.00 mm	125 mm	1	4415-9.00
10.00 mm	125 mm	1	4415-10.00
10.50 mm	133 mm	1	4415-10.50
11.00 mm	142 mm	1	4415-11.00
11.50 mm	142 mm	1	4415-11.50
12.00 mm	151 mm	1	4415-12.00

12.50 mm	151 mm	1	4415-12.50
13.00 mm	151 mm	1	4415-13.00
13.50 mm	160 mm	1	4415-13.50
14.00 mm	160 mm	1	4415-14.00
14.50 mm	169 mm	1	4415-14.50
15.00 mm	169 mm	1	4415-15.00
15.50 mm	178 mm	1	4415-15.50
16.00 mm	178 mm	1	4415-16.00
16.50 mm	184 mm	1	4415-16.50
17.00 mm	184 mm	1	4415-17.00
17.50 mm	191 mm	1	4415-17.50
18.00 mm	191 mm	1	4415-18.00
18.50 mm	198 mm	1	4415-18.50
19.00 mm	198 mm	1	4415-19.00
19.50 mm	205 mm	1	4415-19.50
20.00 mm	205 mm	1	4415-20.00

Size 1 mm up to 4 mm, two drills in each tube

HSS-R-borrar för metall, industripack



4515

1.00 mm	34 mm	1	4515-1.00-10P
1.50 mm	40 mm	1	4515-1.50-10P
2.00 mm	49 mm	1	4515-2.00-10P
2.50 mm	57 mm	1	4515-2.50-10P
3.00 mm	61 mm	1	4515-3.00-10P
3.25 mm	65 mm	1	4515-3.25-10P
3.50 mm	70 mm	1	4515-3.50-10P
4.00 mm	75 mm	1	4515-4.00-10P
4.25 mm	75 mm	1	4515-4.25-10P
4.50 mm	80 mm	1	4515-4.50-10P
5.00 mm	86 mm	1	4515-5.00-10P
5.50 mm	93 mm	1	4515-5.50-10P
6.00 mm	93 mm	1	4515-6.00-10P
6.50 mm	101 mm	1	4515-6.50-10P
7.00 mm	109 mm	1	4515-7.00-10P
7.50 mm	109 mm	1	4515-7.50-10P
8.00 mm	117 mm	1	4515-8.00-10P
8.50 mm	117 mm	1	4515-8.50-10P
9.00 mm	125 mm	1	4515-9.00-10P
9.50 mm	125 mm	1	4515-9.50-10P
10.00 mm	133 mm	1	4515-10.00-10P
10.50 mm	133 mm	1	4515-10.50-5P
11.00 mm	142 mm	1	4515-11.00-5P
11.50 mm	142 mm	1	4515-11.50-5P
12.00 mm	151 mm	1	4515-12.00-5P
12.50 mm	151 mm	1	4515-12.50-5P
13.00 mm	151 mm	1	4515-13.00-5P

Sats med HSS-R-borrar för metall – 19 st.



4515-SET-19

19	600 g	1	4515-SET-19

1,0 mm till 10,0 x 0,5 mm i en plastlåda

HSS-R-borrsats för metall – 25 delar



4515-SET-25

25	1200 g	1	4515-SET-25

1x 1.0; 1.5; 2.0; 2.5; 3.0; 3.5; 4.0; 4.5; 5.0; 5.5; 6.0; 6.5; 7; 7.5; 8; 8.5; 9.0; 9.5; 10; 10.5; 11; 11.5; 12; 12.5; 13 mm1pc Ø 13.0mm

Stegborrar för plåt, 4–12 mm



228-SD

6.35 mm	4-5-6-7-8-9-10-11-12 mm	24	228-SD



Stegborrar för plåt, 4–22 mm



229-SD

10 mm	4-6-8-10-12-14-16-18-20-22 mm	24	229-SD

Stegborrar för plåt, 5–35 mm



230-SD

12.7 mm	5-13-15-17-19-21-23-25-27-29-31-33-35 mm	25	230-SD

Stegborrar för plåt, 6 mm–37 mm



232-SD

10 mm	6-9-12.5-15.2-18.6-20.4-22.5-26-28.3-30.5-34-37 mm	1	232-SD

Stegborrar för plåt, 6.5 mm–40.5 mm



234-SD

10 mm	6.5-8.5-10.5-12.5-16.5-20.5-25.5-29-32.5-36.5-40.5 mm	25	234-SD

HSS stegborrsats–3 st



228-SET

3	560 g	1	228-SET-SD

228-SD

229-SD

230-SD

HSS-G försänkare för metall



4435

12.4 mm	56 mm	1	4435-12.4

Spiralborr för trä



9626

6.0 mm	7.0 mm	1 9626-6
8.0 mm	9.0 mm	1 9626-8
10.0 mm	11.0 mm	1 9626-10
12.0 mm	13.0 mm	1 9626-11
14.0 mm	15.0 mm	1 9626-12
16.0 mm	18.0 mm	1 9626-13
20.0 mm	22.0 mm	1 9626-14
23.0 mm	24.0 mm	1 9626-15
25.0 mm	26.0 mm	1 9626-16
28.0 mm	30.0 mm	1 9626-18
32.0 mm	35.0 mm	1 9626-20
6.0 mm	8.0 mm	1 9626-22
10.0 mm	12.0 mm	1 9626-23
14.0 mm	16.0 mm	1 9626-24
18.0 mm	20.0 mm	1 9626-25
22.0 mm	24.0 mm	1 9626-26
26.0 mm	28.0 mm	1 9626-28
30.0 mm	32.0 mm	1 9626-30
32.0 mm	6.0 mm	1 9626-32
	8.0 mm	1 9626-35
	10.0 mm	1 9627-6-460
	12.0 mm	1 9627-8-460
	14.0 mm	1 9627-10-460
	16.0 mm	1 9627-12-460
	18.0 mm	1 9627-14-460
	20.0 mm	1 9627-16-460
	22.0 mm	1 9627-18-460
	24.0 mm	1 9627-20-460
	26.0 mm	1 9627-22-460
	28.0 mm	1 9627-24-460
	30.0 mm	1 9627-26-460
	32.0 mm	1 9627-28-460
		1 9627-30-460
		1 9627-32-460

Spiralborrsats – 6 st.



SB-9526/S6

6	20	SB-9526/S6

Flatborr för trä



9629

Ø	L		
6.0 mm	152 mm	1	9629-6
8.0 mm	152 mm	1	9629-8
10.0 mm	152 mm	1	9629-10
12.0 mm	152 mm	1	9629-12
13.0 mm	152 mm	1	9629-13
14.0 mm	152 mm	1	9629-14
16.0 mm	152 mm	1	9629-16
17.0 mm	152 mm	1	9629-17
18.0 mm	152 mm	1	9629-18
19.0 mm	152 mm	1	9629-19
20.0 mm	152 mm	1	9629-20
22.0 mm	152 mm	1	9629-22
24.0 mm	152 mm	1	9629-24
25.0 mm	152 mm	1	9629-25
26.0 mm	152 mm	1	9629-26
28.0 mm	152 mm	1	9629-28
30.0 mm	152 mm	1	9629-30
32.0 mm	152 mm	1	9629-32
35.0 mm	152 mm	1	9629-35
36.0 mm	152 mm	1	9629-36
38.0 mm	152 mm	1	9629-38
40.0 mm	152 mm	1	9629-40
6.0 mm	400 mm	1	9631-6-400
8.0 mm	400 mm	1	9631-8-400
10.0 mm	400 mm	1	9631-10-400
12.0 mm	400 mm	1	9631-12-400
13.0 mm	400 mm	1	9631-13-400
14.0 mm	400 mm	1	9631-14-400
16.0 mm	400 mm	1	9631-16-400
18.0 mm	400 mm	1	9631-18-400
19.0 mm	400 mm	1	9631-19-400
20.0 mm	400 mm	1	9631-20-400
22.0 mm	400 mm	1	9631-22-400
24.0 mm	400 mm	1	9631-24-400
25.0 mm	400 mm	1	9631-25-400
28.0 mm	400 mm	1	9631-28-400
30.0 mm	400 mm	1	9631-30-400
32.0 mm	400 mm	1	9631-32-400
35.0 mm	400 mm	1	9631-35-400
38.0 mm	400 mm	1	9631-38-400

Flatborrsats för trä – 8 delar



9629-SET-8

X	g		
8	630 g	10	9629-SET-8

9629-12, 9629-16, 9629-18, 9629-20, 9629-22, 9629-25, 9629-28, 9629-32



Spiralborrsats för trä – 6 delar



9656-SET-6

X	g		
6	720 g	1	9656-SET-6

Spiralborr för trä



9646

Ø			
3 mm		1	9646-3
4 mm		1	9646-4
5 mm		1	9646-5
6 mm		1	9646-6
7 mm		1	9646-7
8 mm		1	9646-8
9 mm		1	9646-9
10 mm		1	9646-10
11 mm		1	9646-11
12 mm		1	9646-12
13 mm		1	9646-13
14 mm		1	9646-14
15 mm		1	9646-15
16 mm		1	9646-16
18 mm		1	9646-18
20 mm		1	9646-20
6 mm		1	9646-6-250
8 mm		1	9646-8-250
10 mm		1	9646-10-250
12 mm		1	9646-12-250

Spiralborrsats för trä – 5 delar



9646-SET-5

X	g		
5	110 g	1	9646-SET-5

9646-4, 9646-5, 9646-6, 9646-8, 9646-10

Spiralborrsats för trä – 8 delar



9646-SET-8

X	g		
8	230 g	1	9646-SET-8

9646-3, 9646-4, 9646-5, 9646-6, 9646-7, 9646-8, 9646-9, 9646-10

Ställbar träborr



9528

Ø			
15-45 mm		10	9528-MD-15-45
22-76 mm		10	9528-MD-22-76



Borrar för kakel



4626

Ø	L		
4 mm	58 mm	1	4626-4.0
5 mm	58 mm	1	4626-5.0
6 mm	58 mm	1	4626-6.0
8 mm	78 mm	1	4626-8.0
10 mm	98 mm	1	4626-10.0

Universalborrsatser för kakel, natursten, trä och plast



4629

Ø	L		
4.0 mm	75 mm	1	4629-4.0
5.0 mm	85 mm	1	4629-5.0
6.0 mm	100 mm	1	4629-6.0
8.0 mm	120 mm	1	4629-8.0
10.0 mm	120 mm	1	4629-10.0

Universalborrsats med hårdmetallspets – 5 delar



4629-SET-5

X	g		
5	165 g	10	4629-SET-5

4629-8.0, 4629-10.0, 4629-4.0, 4629-5.0, 4629-6.0

Förlängningskraft 305 mm, 1/4" snabblossning



9625-6.35QC

Ø	L		
6.35 mm	305 mm	1	9625-6.35QC

Förlängningskraft, 330 mm



9525

Ø	L		
14-19 mm		1	9525-7
20-32 mm		1	9525-10

BITS

1/4" diamanttorsionsbits för Phillips®-skruv, 25 mm



63D/PH

X			
5	3	1	63D/PH3

1/4" diamanttorsionsbits för Phillips®-skruv för gipsskivor, 25 mm



63D/PH2G

X			
5	PH2G	1	63D/PH2G

1/4" diamanttorsionsbits för Pozidriv®-skruv, 25 mm



63D/PZ

X			
5	2	1	63D/PZ2

1/4" diamanttorsionsbits för Torx®-skruv, 25 mm



63D/T

X			
5	T10	1	63D/T10
5	T15	1	63D/T15
5	T40	1	63D/T40

1/4" diamanttorsionsbits för Pozidriv®-skruv, 50 mm – 5 st. i plastask



63D/50PZ

5	1	1	63D/50PZ1
5	2	1	63D/50PZ2
5	3	1	63D/50PZ3

1/4" TiN torsionsbits för Pozidriv®-skruv, 25 mm



62TIN/PZ

10	1	1	62TIN/PZ1
10	2	1	62TIN/PZ2
10	3	1	62TIN/PZ3

1/4" TiN torsionsbits för Pozidriv®-skruv, 50 mm



62TIN/50PZ

5	1	1	62TIN/50PZ1
5	2	1	62TIN/50PZ2
5	3	1	62TIN/50PZ3

1/4" sats med diamanttorsionsbits för Phillips®-/Pozidriv®-/Torx®-skruv med bitshållare



63D/7

7	20 x 50 x 80 mm	1	63D/7-1

1 adaptor

63D/PH2		
63D/PZ2		
63D/T10, 63D/T15, 63D/T25, 63D/T30		

1/4" TiN torsionsbits för Torx®-skruv, 25 mm



62TIN/T

10	T15	1	62TIN/T15
10	T20	1	62TIN/T20
10	T25	1	62TIN/T25
10	T30	1	62TIN/T30

1/4" TiN torsionsbitsats för Phillips®, Pozidriv® och Torx®-skruv



62TIN/7

7	22 x 65 x 75 mm	1	62TIN/7-1

includes a bit holder

62TIN/PH2		
62TIN/PZ2		
62TIN/T15, 62TIN/T20, 62TIN/T25, 62TIN/T30		

1/4" TiN torsionsbits för Phillips®-skruv, 25 mm



62TIN/PH

10	1	1	62TIN/PH1

1/4" TiN torsionsbits för Phillips®-skruv, 50 mm



62TIN/50PH

5	1	1	62TIN/50PH1
5	3	1	62TIN/50PH3

1/4" ACR-torsionsbits för Phillips®-skruv, 25 mm



64A/PH

10	1	1	64A/PH1
10	3	1	64A/PH3



1/4" ACR-torsionsbits för Pozidriv®-skruv, 25 mm



64A/PZ

X	+	+	
10	1	1	64A/PZ1
10	3	1	64A/PZ3

1/4" torsionsbits för Phillips®-skruv, 25 mm



60T/PH

X	+	+	
10	1	1	60T/PH1
10	2	1	60T/PH2
10	3	1	60T/PH3

1/4" torsionsbits för Pozidriv®-skruv, 25 mm



60T/PZ

X	+	+	
10	1	1	60T/PZ1
10	2	1	60T/PZ2
10	3	1	60T/PZ3

1/4" torsionsbits för Torx®-skruv, 25 mm



60T/T

X	+	+	
10			T7
10			T9
10			T15
10			T20
10			T25
10			T27
10			T40

1/4" torsionsbitssats för Phillips®, Pozidriv® och Torx®-skruv



60T/7

X	+	+	
7			22 x 65 x 75 mm
			1 60T/7-1

Includes a bit holder

60T/PH2	+	+	
60T/PZ2	+	+	
60T/T10, 60T/T15, 60T/T20, 60T/T30	+	+	

1/4" torsionsbitssats för Phillips® och Torx®-skruv



60T/17

X	+	+	
17			27 x 73 x 82 mm
			1 60T/17-1

Innehåller en bitshållare på 50 mm

60T/PH1, 60T/PH2	+	+	
60T/T7, 60T/T8, 60T/T9, 60T/T10, 60T/T15x 2, 60T/T20x 2, 60T/T25x 2, 60T/T27, 60T/T30x 2, 60T/T40	+	+	

1/4" torsionsbitssats för spår-, Phillips®, Pozidriv-, Torx®- och insexskruv



60T/31

X	+	+	
31			42 x 65 x 110 mm
			12 60T/31-1

Includes a bit holder of 50mm

59S/0.6-4.5, 59S/0.8-5.5	+	+	
60T/PH1, 60T/PH2x 3, 60T/PH3	+	+	
59S/PH2Gx 2	+	+	
60T/PZ1, 60T/PZ2x 3, 60T/PZ3	+	+	
60T/T10, 60T/T15x 3, 60T/T20x 3, 60T/T25x 2, 60T/T27, 60T/T30x 2	+	+	
59S/H3, 59S/H4, 59S/H5, 59S/H6	+	+	

1/4" extra hårda torsionsbits för Phillips®-skruv, 25 mm



61H/PH

X	+	+	
10			1 61H/PH1
10			2 61H/PH2
5			3 61H/PH3

1/4" extra hårda torsionsbits för Phillips®-skruv, 50 mm



61H/50PH

5	1	1	61H/50PH1



1/4" extra hårda torsionsbits för Torx®-skruv, 50 mm



61H/50T

5	T10	1	61H/50T10
5	T15	1	61H/50T15
5	T25	1	61H/50T25
5	T30	1	61H/50T30



1/4" krafttorsionsbits för Pozidriv®-skruv. Längd 25 mm



66IM/PZ

2	1	1	66IM/PZ1-2P
2	2	1	66IM/PZ2-2P
2	3	1	66IM/PZ3-2P



1/4" extra hårda torsionsbits för Pozidriv®-skruv, 25 mm



61H/PZ

5	3	1	61H/PZ3



1/4" extra hårda torsionsbits för Torx®-skruv, 25 mm



61H/T

10	T10	1	61H/T10
10	T20	1	61H/T20
10	T25	1	61H/T25
5	T40	1	61H/T40



1/4" krafttorsionsbits för Torx®-skruv. Längd 25 mm



66IM/T

2	T10	1	66IM/T10C-2P
2	T15	1	66IM/T15C-2P
2	T20	1	66IM/T20C-2P
2	T25	1	66IM/T25C-2P
2	T27	1	66IM/T27C-2P
2	T20	1	66IM/T30C-2P
2	T40	1	66IM/T40C-2P



1/4" extra hårda torsionsbits för Pozidriv®-skruv, 50 mm



61H/50PZ

5	1	1	61H/50PZ1
5	2	1	61H/50PZ2
5	3	1	61H/50PZ3



1/4" krafttorsionsbits för Phillips®-skruv. Längd 25 mm



66IM/PH

2	1	1	66IM/PH1-2P
2	2	1	66IM/PH2-2P
2	3	1	66IM/PH3-2P



1/4" krafttorsionsbits för Phillips®-skruv. Längd 50 mm



66IM/50PH

2	1	1	66IM/50PH1-2P
2	2	1	66IM/50PH2-2P
2	3	1	66IM/50PH3-2P



1/4" krafttorsionsbits för Pozidriv-skruv.
Längd 50 mm



66IM/50PZ

X	+	+	+
2	1	1	66IM/50PZ1-2P
2	2	1	66IM/50PZ2-2P
2	3	1	66IM/50PZ3-2P

1/4" krafttorsionsbits för Phillips-, Pozidriv-
och Torx®-skruv i mjuk plasthållare. 10
delar



66IM/10C-1

X	+	+	+
10	10 x 50 x 140 mm	40	66IM/10C-1

66IM/50PH2-2Px 2, 66IM/50PH3-2P	+	
66IM/50PZ2-2Px 2, 66IM/50PZ3-2P	+	
66IM/50T20C-2Px 2, 66IM/50T25C-2P, 66IM/50T30C-2P	+	

1/4" krafttorsionsbits för Torx®-skruv. Längd
50 mm



66IM/50TC

X	+	+	+
2	10	1	66IM/50T10C-2P
2	15	1	66IM/50T15C-2P
2	20	1	66IM/50T20C-2P
2	25	1	66IM/50T25C-2P
2	27	1	66IM/50T27C-2P
2	30	1	66IM/50T30C-2P
2	40	1	66IM/50T40C-2P

1/4" standardbits för spårskruv, 25 mm



1/4" standardbits för Phillips®-skruv, 25 mm



59S/PH

X	+	+	+
10	0	1	59S/PH0
3	0	50	59S/PH0-3P
10	1	1	59S/PH1
3	1	1	59S/PH1-3P
30	1	1	59S/PH1-30P
100	*1	100	59S/PH1-IP
500	1	500	59S/PH1-IPB
10	2	1	59S/PH2
3	2	1	59S/PH2-3P
30	2	1	59S/PH2-30P
100	*2	100	59S/PH2-IP
500	*2	500	59S/PH2-IPB
10	3	1	59S/PH3
3	3	1	59S/PH3-3P
30	3	1	59S/PH3-30P
500	3	500	59S/PH3-IPB
10	4	1	59S/PH4
3	4	25	59S/PH4-3P

1/4" krafttorsionsbits för Phillips-, Pozidriv-
och Torx®-skruv i mjuk plasthållare. 11
delar



66IM/11C-1

X	+	+	+
11	25 x 37 x 140 mm	40	66IM/11C-1

66IM/PH2-2Px 2, 66IM/PH3-2P	+	
66IM/PZ2-2Px 2, 66IM/PZ3-2P	+	
66IM/T20C-2Px 2, 66IM/T25C-2P, 66IM/T30C-2P	+	
KMT753-QR-1P	○	

59S/

X	+	+	+
10	3.0 mm	1	59S/0.5-3.0
3	3.0 mm	50	59S/0.5-3.0-3P
10	4.0 mm	1	59S/0.5-4.0
3	4.0 mm	50	59S/0.5-4.0-3P
10	3.5 mm	1	59S/0.6-3.5
3	3.5 mm	50	59S/0.6-3.5-3P
10	4.5 mm	1	59S/0.6-4.5
3	4.5 mm	1	59S/0.6-4.5-3P
10	5.5 mm	1	59S/0.8-5.5
3	5.5 mm	1	59S/0.8-5.5-3P
10	5.5 mm	1	59S/1.0-5.5
3	5.5 mm	50	59S/1.0-5.5-3P
10	6.5 mm	1	59S/1.2-6.5
3	6.5 mm	50	59S/1.2-6.5-3P
10	8.0 mm	1	59S/1.2-8.0
3	8.0 mm	1	59S/1.2-8.0-3P
10	9.0 mm	1	59S/1.6-9.0
10	10 mm	1	59S/1.6-10
3	9.0 mm	50	59S/1.6-9.0-3P
3	10.0 mm	50	59S/1.6-10-3P

1/4" standardbits för Phillips®-gippskruv,
25 mm



59S/PH2G

X	+	+	+
10	PH 2G	1	59S/PH2G
3	PH 2G	50	59S/PH2G-3P
30	PH2G	1	59S/PH2G-30P

1/4" standardbits för Pozidriv®-skruv,
25 mm



59S/PZ

X	+		
10	0	1	59S/PZ0
3	0	50	59S/PZ0-3P
10	1	1	59S/PZ1
3	1	1	59S/PZ1-3P
30	1	1	59S/PZ1-30P
100	*1	100	59S/PZ1-IP
500	*1	500	59S/PZ1-IPB
10	2	1	59S/PZ2
3	2	1	59S/PZ2-3P
30	2	1	59S/PZ2-30P
100	*2	100	59S/PZ2-IP
500	*2	500	59S/PZ2-IPB
10	3	1	59S/PZ3
3	3	1	59S/PZ3-3P
30	3	1	59S/PZ3-30P
500	3	500	59S/PZ3-IPB
10	4	1	59S/PZ4

1/4" standardbits för Torx®-skruvar, 25 mm



59S/T

X	T		
5	T3	1	59S/T3
3	T3	50	59S/T3-3P
5	T4	1	59S/T4
3	T4	50	59S/T4-3P
5	T5	1	59S/T5
3	T5	50	59S/T5-3P
10	T6	1	59S/T6
3	T6	50	59S/T6-3P
10	T7	1	59S/T7
3	T7	50	59S/T7-3P
10	T8	1	59S/T8
3	T8	50	59S/T8-3P
10	T9	1	59S/T9
3	T9	50	59S/T9-3P
10	T10	1	59S/T10
3	T10	1	59S/T10-3P
30	T10	1	59S/T10-30P
10	T15	1	59S/T15

X	T		
3	T15	1	59S/T15-3P
30	T15	1	59S/T15-30P
10	T20	1	59S/T20
3	T20	1	59S/T20-3P
30	T20	1	59S/T20-30P
10	T25	1	59S/T25
3	T25	1	59S/T25-3P
30	T25	1	59S/T25-30P
10	T27	1	59S/T27
3	T27	1	59S/T27-3P
5	T30	1	59S/T30
3	T30	1	59S/T30-3P
30	T30	1	59S/T30-30P
5	T40	1	59S/T40
3	T40	1	59S/T40-3P
30	T40	1	59S/T40-30P
5	T45	1	59S/T45
3	T45	50	59S/T45-3P
5	T50	1	59S/T50
3	T50	50	59S/T50-3P

1/4" koniska standardbits för Torx®-skruvar,
25 mm



59S/TCS

X	T		
10	T10	20	59S/T10CS
10	T15	20	59S/T15CS
10	T20	20	59S/T20CS
10	T25	20	59S/T25CS
10	T27	20	59S/T27CS
10	T30	20	59S/T30CS
10	T40	20	59S/T40CS

1/4" standardbits för Torx®-skruv med
centrumpets, 25 mm



59S/TR

X	T		
5	TR7	1	59S/TR7
3	TR7	50	59S/TR7-3P

X	T		
5	TR8	1	59S/TR8
3	TR8	50	59S/TR8-3P
5	TR9	1	59S/TR9
3	TR9	50	59S/TR9-3P
5	TR10	1	59S/TR10
3	TR10	1	59S/TR10-3P
5	TR15	1	59S/TR15
3	TR15	1	59S/TR15-3P
5	TR20	1	59S/TR20
3	TR20	1	59S/TR20-3P
5	TR25	1	59S/TR25
3	TR25	1	59S/TR25-3P
5	TR27	1	59S/TR27
3	TR27	1	59S/TR27-3P
5	TR30	1	59S/TR30
3	TR30	1	59S/TR30-3P
5	TR40	1	59S/TR40
3	TR40	1	59S/TR40-3P

1/4" standardbits för metrisk insexskruv,
25 mm



59S/H mm

X	H		
5	1.5	1	59S/H1.5
3	1.5	50	59S/H1.5-3P
5	2	1	59S/H2
3	2	50	59S/H2-3P
5	2.5	1	59S/H2.5
3	2.5	50	59S/H2.5-3P
5	3	1	59S/H3
3	3	1	59S/H3-3P
5	4	1	59S/H4
3	4	1	59S/H4-3P
500	4	500	59S/H4-IPB
5	5	1	59S/H5
3	5	1	59S/H5-3P
5	6	1	59S/H6
3	6	1	59S/H6-3P
5	8	1	59S/H8
3	8	1	59S/H8-3P
5	10	1	59S/H10
3	10	25	59S/H10-3P



1/4" standardbits för insexskruv (tum), 25 mm



59S/H "

X			
5	1/16 in	1	59S/H1/16
3	1/16 in	50	59S/H1/16-3P
5	5/64 in	1	59S/H5/64
3	5/64 in	50	59S/H5/64-3P
5	3/32 in	1	59S/H3/32
3	3/32 in	50	59S/H3/32-3P
5	7/64 in	1	59S/H7/64
3	7/64 in	50	59S/H7/64-3P
5	1/8 in	1	59S/H1/8
3	1/8 in	50	59S/H1/8-3P
5	9/64 in	1	59S/H9/64
3	9/64 in	1	59S/H9/64-3P
5	5/32 in	1	59S/H5/32
3	5/32 in	50	59S/H5/32-3P
5	3/16 in	1	59S/H3/16
3	3/16 in	1	59S/H3/16-3P
5	7/32 in	1	59S/H7/32
3	7/32 in	50	59S/H7/32-3P
5	1/4 in	1	59S/H1/4
3	1/4 in	50	59S/H1/4-3P
5	5/16 in	1	59S/H5/16
3	5/16 in	50	59S/H5/16-3P
5	3/8 in	1	59S/H3/8
3	3/8 in	25	59S/H3/8-3P

1/4" standardbits för Robertson-skruv, 25 mm



59S/R

X			
10	#1	1	59S/R1
3	#1	1	59S/R1-3P
10	#2	1	59S/R2
3	#2	1	59S/R2-3P
10	#3	1	59S/R3
3	#3	1	59S/R3-3P
10	#4	1	59S/R4

1/4" standardbits för Torq-Set® säkerhetsskruv, 25 mm – 5 st. i plastask



59S/TS

X			
5	0	1	59S/TS-0
5	1	1	59S/TS-1
5	2	1	59S/TS-2
5	3	1	59S/TS-3
5	4	1	59S/TS-4
5	5	1	59S/TS-5
5	6	1	59S/TS-6
5	8	1	59S/TS-8
5	10	1	59S/TS-10

1/4" standardbits för Torq-Set®-skruvar (tum), 25 mm



59S/TS "

X			
5	1/4"	1	59S/TS-1/4

1/4" standardbits för TriWing-skrivar, 25 mm – 5 st. i plastask



59S/TW

X			
5	TW 0	1	59S/TW0
5	TW 1	1	59S/TW1
5	TW 2	1	59S/TW2
5	TW 3	1	59S/TW3
5	TW 4	1	59S/TW4
5	TW 5	1	59S/TW5

1/4" standardbits för XZN-skruv, 25 mm



59S/M

X			
10	M3	1	59S/M3
3	M3	50	59S/M3-3P
10	M4	1	59S/M4
3	M4	50	59S/M4-3P
10	M5	1	59S/M5
3	M5	50	59S/M5-3P
10	M6	1	59S/M6
3	M6	50	59S/M6-3P
10	M8	1	59S/M8
3	M8	50	59S/M8-3P

1/4" standardbits för spårskruv, 50 mm



59S/50

X			
5	3.5 mm	1	59S/50/0.6-3.5
5	4.0 mm	1	59S/50/0.8-4.0
5	5.5 mm	1	59S/50/0.8-5.5
5	6.0 mm	1	59S/50/1.0-6.0
5	6.5 mm	1	59S/50/1.2-6.5
2	3.5 mm	50	59S/50/3.5-2P
2	4.0 mm	50	59S/50/4.0-2P
2	5.5 mm	50	59S/50/5.5-2P
2	6.0 mm	1	59S/50/6.0-2P
2	6.5 mm	50	59S/50/6.5-2P

1/4" standardbits för Phillips®-skruv, 50 mm



59S/50PH

X			
5	1	1	59S/50PH1
2	1	1	59S/50PH1-2P
5	2	1	59S/50PH2
2	2	1	59S/50PH2-2P
5	3	1	59S/50PH3
2	3	1	59S/50PH3-2P

1/4" standardbits för Pozidriv®-skruv, 50 mm



59S/50PZ

X	+		
5	1	1	59S/50PZ1
2	1	1	59S/50PZ1-2P
5	2	1	59S/50PZ2
2	2	1	59S/50PZ2-2P
5	3	1	59S/50PZ3
2	3	1	59S/50PZ3-2P

1/4" standardbits för Torx®-skruv, 50 mm



59S/50T

X	*		
5	T 8	1	59S/50T8
2	T 8	50	59S/50T8-2P
5	T 10	1	59S/50T10
2	T10	1	59S/50T10-2P
5	T 15	1	59S/50T15
2	T15	1	59S/50T15-2P
5	T 20	1	59S/50T20
2	T20	1	59S/50T20-2P
5	T 25	1	59S/50T25
2	T25	1	59S/50T25-2P
5	T 27	1	59S/50T27
5	T 30	1	59S/50T30
2	T30	1	59S/50T30-2P
5	T 40	1	59S/50T40
2	T40	50	59S/50T40-2P

1/4" standardbits för metrisk insexskruv, 50 mm



59S/50H

X	●		
5	2	1	59S/50H2
2	2	50	59S/50H2-2P
5	2.5	1	59S/50H2.5

X	●		
2	2.5	50	59S/50H2.5-2P
5	3	1	59S/50H3
2	3	50	59S/50H3-2P
5	4	1	59S/50H4
2	4	50	59S/50H4-2P
5	5	1	59S/50H5
2	5	50	59S/50H5-2P
5	6	1	59S/50H6
2	6	50	59S/50H6-2P
5	8	1	59S/50H8
2	8	50	59S/50H8-2P

1/4" standardbits för insexskruv (tum), 50 mm



59S/50H "

X	●		
5	1/1 in	1	59S/50H1/16
5	5/64 in	1	59S/50H5/64
5	3/32 in	1	59S/50H3/32
5	7/64 in	1	59S/50H7/64
5	1/8 in	1	59S/50H1/8
5	9/64 in	1	59S/50H9/64
5	5/32 in	1	59S/50H5/32
5	3/16 in	1	59S/50H3/16
5	7/32 in	1	59S/50H7/32
5	1/4 in	1	59S/50H1/4
5	5/16 in	1	59S/50H5/16
5	3/8 in	1	59S/50H3/8

1/4" standardbits för Robertson-skriv, 50 mm



59S/50R

X	●		
5	#1	1	59S/50R1
2	#1	50	59S/50R1-2P
5	#2	1	59S/50R2
2	#2	50	59S/50R2-2P
5	#3	1	59S/50R3
2	#3	50	59S/50R3-2P

1/4" standardbits för Phillips®-skruv, 70 mm



59S/70PH

X	+		
5	1	1	59S/70PH1
2	1	1	59S/70PH1-2P
5	2	1	59S/70PH2
2	2	25	59S/70PH2-2P

1/4" standardbits för Pozidriv®-skruv, 70 mm



59S/70PZ

X	+		
5	1	1	59S/70PZ1
2	1	1	59S/70PZ1-2P
5	2	1	59S/70PZ2
2	2	1	59S/70PZ2-2P
5	3	1	59S/70PZ3
2	3	1	59S/70PZ3-2P

1/4" standardbits för Torx®-skruvar, 70 mm



59S/70T

X	*		
5	T10	1	59S/70T10
2	T10	1	59S/70T10-2P
5	T15	1	59S/70T15
2	T15	25	59S/70T15-2P
2	T20	1	59S/70T20-2P
5	T20	1	59S/70T20
2	T25	25	59S/70T25-2P
5	T25	1	59S/70T25
2	T27	1	59S/70T27-2P
5	T27	1	59S/70T27
2	T30	1	59S/70T30-2P
5	T30	1	59S/70T30
2	T40	1	59S/70T40-2P
5	T40	1	59S/70T40



1/4" standardbits för Torx®-skruv med centrumpets, 70 mm



59S/70TR

5	TR15	1	59S/70TR15
2	TR15	1	59S/70TR15-2P
5	TR20	1	59S/70TR20
2	TR20	25	59S/70TR20-2P
5	TR25	1	59S/70TR25
2	TR25	25	59S/70TR25-2P
5	TR27	1	59S/70TR27
2	TR27	25	59S/70TR27-2P
5	TR30	1	59S/70TR30
2	TR30	25	59S/70TR30-2P
5	TR40	1	59S/70TR40
2	TR40	25	59S/70TR40-2P

1/4" standardbits med kula för insexskruv, 89 mm



59S/H BALL

5	3	1	59S/H3BALL
2	3	1	59S/H3BALL-2P
5	4	1	59S/H4BALL
2	4	1	59S/H4BALL-2P
5	5	1	59S/H5BALL
2	5	1	59S/H5BALL-2P
5	6	1	59S/H6BALL
2	6	1	59S/H6BALL-2P
5	8	1	59S/H8BALL
2	8	1	59S/H8BALL-2P
3	5,6,8	1	59S/HBALL-3P

1/4" standardbits för Phillips®-skruv, 125 mm



59S/125PH

5	1	1	59S/125PH1
2	1	25	59S/125PH1-2P
5	2	1	59S/125PH2
2	2	25	59S/125PH2-2P
100	2	100	59S/125PH2-1P
2	3	25	59S/125PH3-2P
5	3	1	59S/125PH3

1/4" standardbits för Pozidriv®-skruv, 125 mm



59S/125PZ

5	1	1	59S/125PZ1
2	1	25	59S/125PZ1-2P
5	2	1	59S/125PZ2
2	2	25	59S/125PZ2-2P
5	3	1	59S/125PZ3
2	3	25	59S/125PZ3-2P

1/4" standardbits för Phillips®- och spårskruv, 125 mm



59S/PH COMBI

2	5.0/PH1	1	59S/PH1COMBI-2P
2	6.0/PH2	1	59S/PH2COMBI-2P
2	8.0/PH3	1	59S/PH3COMBI-2P

1/4" standardbits för Torx®-skruv, 150 mm



59S/150T

5	T15	1	59S/150T15
2	T15	1	59S/150T15-2P
5	T20	1	59S/150T20
2	T20	1	59S/150T20-2P
5	T25	1	59S/150T25
2	T25	1	59S/150T25-2P
5	T30	1	59S/150T30
2	T30	1	59S/150T30-2P

7/16" bits för slagskruvmejsel, insexskruv, 35 mm



74S/H

5	4 mm	1	74S/H4
2	4 mm	25	74S/H4-2P
5	5 mm	1	74S/H5
2	5 mm	25	74S/H5-2P
5	6 mm	1	74S/H6
2	6 mm	25	74S/H6-2P
5	7 mm	1	74S/H7
2	7 mm	25	74S/H7-2P
5	8 mm	1	74S/H8
2	8 mm	25	74S/H8-2P
5	10 mm	1	74S/H10
2	10 mm	25	74S/H10-2P
5	12 mm	1	74S/H12
2	12 mm	25	74S/H12-2P
5	14 mm	1	74S/H14
2	14 mm	1	74S/H14-2P
5	17 mm	1	74S/H17
2	17 mm	25	74S/H17-2P

5/32" standardbits för Phillips®-skruv, 25 mm



45S/PH

5	1	1	45S/PH1
2	1	50	45S/PH1-2P
5	2	1	45S/PH2
2	2	50	45S/PH2-2P

5/32" standardbits för insexskruv, 25 mm



45S/H

5	1.5 mm	1	45S/H1.5
2	1.5 mm	50	45S/H1.5-2P
5	2 mm	1	45S/H2
2	2 mm	50	45S/H2-2P
5	2.5 mm	1	45S/H2.5
2	2.5 mm	50	45S/H2.5-2P
5	3 mm	1	45S/H3
2	3 mm	50	45S/H3-2P

1/4" bitssats för Phillips®, Pozidriv® och Torx®-skruv – 7 delar



59S/7-1

7	22 x 65 x 75 mm	1	59S/7-1

includes a bit holder of 50mm

59S/PH1, 59S/PH2		
59S/PZ1, 59S/PZ2		
59S/T15, 59S/T20		

1/4" bitssats för Phillips® och Torx®-skruv – 7 delar



59S/7-2

7	22 x 65 x 75 mm	1	59S/7-2

includes a bit holder of 50mm

59S/PH2		
59S/T15x 2, 59S/T20x 2, 59S/T25		

1/4" bitssats för Torx®-skruv med centrumpets – 7 delar



59S/7-3

7	22 x 65 x 75 mm	1	59S/7-3

includes a bit holder of 50mm

59S/TR10, 59S/TR15, 59S/TR20, 59S/TR25, 59S/TR30, 59S/TR40		
--	--	--

1/4" bitssats för Torx®-skruv – 7 delar



59S/7-4

7	22 x 65 x 75 mm	1	59S/7-4

includes a bit holder of 50mm

59S/T10, 59S/T15, 59S/T20, 59S/T25, 59S/T30, 59S/T40		
--	--	--

1/4" bitssats för Phillips®, Pozidriv® och Torx®-skruv i plasthållare med bältesklämma – 10 delar



59S/10BC

10	23 x 68 x 168 mm	1	59S/10BC

Bitssats 1/4" med koniska bits för Torx®-skruv – 11 delar



59S/TCS11-1

11	108 x 68 x 31 mm	10	59S/TCS11-1

59S/T10CS, 59S/T15CS, 59S/T20CSx 3, 59S/T25CSx 2, 59S/T30CSx 2, 59S/T40CS		
KM653-QR-1P		

1/4" bitssats för spår-, Phillips®, Pozidriv® och insexskruv – 17 delar



59S/17-1

17	27 x 73 x 82 mm	1	59S/17-1

includes a bit holder of 50mm

59S/0.5-3.0, 59S/0.6-4.5, 59S/0.8-5.5		
59S/PH1, 59S/PH2x 3		
59S/PH2Gx 2		
59S/PZ1, 59S/PZ2x 2		
59S/H3, 59S/H4, 59S/H5, 59S/H6		



1/4" bitsats för Torx®-skruv – 17 delar



59S/17-2

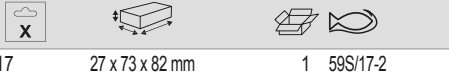

17 27 x 73 x 82 mm 1 59S/17-2

includes a bit holder of 50mm

59S/T7, 59S/T8, 59S/T9, 59S/T10, 59S/T15x 2, 59S/T20x 3, 59S/T25x 3, 59S/T27, 59S/T30x 2, 59S/T40	
---	--

1/4" bitsats för Pozidriv®, Phillips®, Torx®, insexskruv – 17 delar



59S/17-3

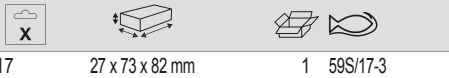

17 27 x 73 x 82 mm 1 59S/17-3

includes a bit holder of 50mm

59S/PH1, 59S/PH2x 2	
59S/PZ1, 59S/PZ2, 59S/PZ3	
59S/T10, 59S/T15, 59S/T20, 59S/T25, 59S/T27, 59S/T30, 59S/T40	
59S/H3, 59S/H4, 59S/H5	

1/4" bits i gummi-hållare för spår-, Phillips-, Pozidriv- och Torx®-skruv – 22 delar



59S/22-1

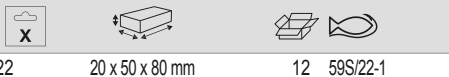

22 20 x 50 x 80 mm 12 59S/22-1

includes a bit holder of 50mm

59S/0.5-3.0, 59S/0.6-4.5, 59S/0.8-5.5	
59S/PH1, 59S/PH2, 59S/PH3	
59S/PH2G	
59S/PZ1, 59S/PZ2, 59S/PZ3	
59S/T6, 59S/T8, 59S/T9, 59S/T10, 59S/T15, 59S/T20, 59S/T25, 59S/T27, 59S/T30, 59S/T40	
K6650-1/4	

1/4" bitsats med gummi-hållare för Phillips®, Pozidriv, Torx®- och insexskruv – 22 delar



59S/22-2

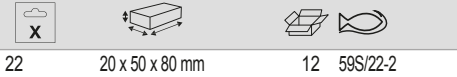

22 20 x 50 x 80 mm 12 59S/22-2

includes a bit holder of 50mm

59S/PH2x 3	
59S/PH2Gx 3	
59S/PZ2x 2	
59S/T10, 59S/T15x 4, 59S/T20x 3, 59S/T25x 2	
59S/H2.5, 59S/H3	
K6650-1/4	

1/4" bitsats för spår-, Phillips®, Torx®, insex-, och Torq-Set-skruv – 28 delar



59S/28

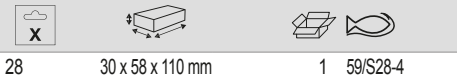

28 30 x 58 x 110 mm 1 59S/28-4

59S/0.6-4.5, 59S/1.2-6.5, 59S/1.2-8.0	
59S/PH1x 2, 59S/PH2x 2, 59S/PH3	
59S/T6, 59S/T15	
59S/H5/64, 59S/H3/32, 59S/H7/64, 59S/H1/8, 59S/H9/64, 59S/H5/32, 59S/H3/16, 59S/H7/32	
59S/TS-4x 2, 59S/TS-6x 2, 59S/TS-8x 2, 59S/TS-10x 2	
K6625-1/4	
KM653	

1/4" bitsats för spår-, Phillips®, Pozidriv-, Torx®- och insexskruv – 31 delar



59S/31B

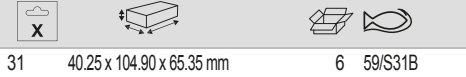

31 40.25 x 104.90 x 65.35 mm 6 59S/31B

Bitshållare med snabbfäste, KM653-QR

59S/0.6-4.5, 59S/1.0-5.5	
59S/PH1, 59S/PH2x 3, 59S/PH3	
59S/PH2Gx 2	
59S/PZ1, 59S/PZ2x 3, 59S/PZ3	
59S/T10, 59S/T15x 3, 59S/T20x 3, 59S/T25x 2, 59S/T27, 59S/T30	
59S/H3, 59S/H4, 59S/H5, 59S/H6	
K6625-1/4-1P	
KM653-QR-1P	

1/4" bitsats för spår-, Phillips®, Pozidriv-, Torx®- och insexskruv – 31 delar



59S/31B-IP

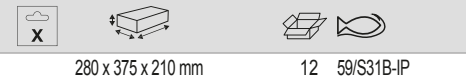

280 x 375 x 210 mm 12 59S/31B-IP

Order 12 pieces of the ref. 59S/31B-IP to receive 1 display Bitshållare med snabbfäste, KM653-QR

Standardbitsats med bitshållare – 28 st



59S/31-1

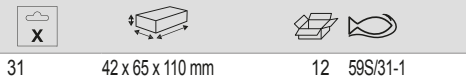

31 42 x 65 x 110 mm 12 59S/31-1

59S/0.5-3.0, 59S/0.6-4.5, 59S/0.8-5.5		
59S/PH1, 59S/PH2x 3, 59S/PH3		
59S/PH2Gx 2		
59S/PZ1, 59S/PZ2x 3, 59S/PZ3		
59S/T10, 59S/T15x 3, 59S/T20x 3, 59S/T25x 2, 59S/T27, 59S/T30		
59S/H3, 59S/H4, 59S/H5, 59S/H6		
KM653-QR		

1/4" bitssats för Phillips®, Pozidriv- och Torx®-skruv – 31 delar



59S/31-2				
31	42 x 65 x 110 mm	1	59S/31-2	

Includes a bit holder of 50mm

59S/PH2x 4		
59S/PH2Gx 4		
59S/PZ2x 4		
59S/T10x 2, 59S/T15x 4, 59S/T20x 5, 59S/T25x 5, 59S/T30x 2		
KM653-QR		

1/4" bitssats för Phillips®, Pozidriv®- och Torx®-skruv med centrumspets – 31 delar



59S/31-3				
31	42 x 65 x 110 mm	12	59S/31-3	

59S/PH1x 2, 59S/PH2x 2, 59S/PH3		
59S/PZ1x 2, 59S/PZ2x 2, 59S/PZ3		
59S/TR10x 2, 59S/TR15x 3, 59S/TR20x 5, 59S/TR25x 4, 59S/TR27, 59S/TR30x 4, 59S/TR40		
KM653-QR		

Bitssats 1/4" för sexkants- och Torx®-skruv – 35 delar



59/S35BC				
35	50 x 110 x 180 mm	1	59/S35BC	

1/4" bitssats för spår-, Phillips®, Pozidriv-, insex-, Torx®- och Torx®-skruv med centrumspets och Robertsonskruv – 54 delar



59/S54BC				
54	50 x 110 x 184 mm	10	59/S54BC	

TORX bits are colored to easy identify the size of the tip Torx-bits med färgmarkering
Hylsadapter 1/4", bitshållare med snabbfäste 1/4" samt magnetisk universalthållare 1/4"

1/4" bitssats för spår-, Phillips®, Pozidriv-, insex- och Torx®-skruv, Torx®TR-skruv med centrumspets och Robertsonskruv – 54 delar/sats och 8 satser/display



59/S54BC-IP				
54	300 x 190 x 280 mm	8	59/S54BC-IP	

Torx-bits med färgmarkering TORX bits are colored to easy identify the size of the tip

1/4" bitssats för spår-, Phillips®, Pozidriv-, insex-, Torx®, Torx® TR-skruv med centrumspets och Robertsonskruv – 100 delar



59/S100BC				
100	50 x 110 x 184 mm	1	59/S100BC	

Torx-bits med färgmarkering Magnetisk universalthållare, KM653

1/4" bitssats för spår-, Phillips®, Pozidriv-, insex-, Torx®, Torx® TR-skruv med centrumspets och Robertsonskruv – 100 delar



59/S100BC-IP				
100	300 x 190 x 280 mm	8	59/S100BC-IP	

Torx-bits med färgmarkering TORX bits are colored to easy identify the size of the tip Magnetisk universalthållare, KM653



1/4" sats med hylsor och standardbits för spår-, Phillips-, Pozidriv-, Torx®- och insexskruv – 26 delar



2058/S26

26	80 x 100 x 35 mm	30	2058/S26
26	35 x 85 x 105 mm	1	SB-2058/S26

SB: Hängförpackade

2058-BR	
K6625-1/4-1P	
59S/H6, 59S/H5, 59S/H4, 59S/H3	
59S/T15, 59S/T10, 59S/T30, 59S/T25, 59S/T20	
59S/PZ3, 59S/PZ1, 59S/PZ2	
59S/PH1, 59S/PH2, 59S/PH3	
59S/0.8-5.5, 59S/0.5-4.0	
6700SM-8, 6700SM-7, 6700SM-6, 6700SM-13, 6700SM-10	
KM753-QR-1P	

1/4" sats med små hylsor och bits för spår-, Phillips-, Pozidriv-, Torx®- och insexskruv – 26 delar



2058/S26-2

80 x 100 x 35 mm	1	2058/S26-2	

2058-BR	
6700SM-8, 6700SM-7, 6700SM-6, 6700SM-5, 6700SM-4	
KM753-QR-1P	
K6625-1/4	
59S/0.5-3.0, 59S/0.8-5.5, 59S/0.5-4.0	
59S/T8, 59S/T7, 59S/T6, 59S/T5, 59S/T4	
59S/PZ1, 59S/PZ0, 59S/PZ2	
59S/H2, 59S/H2.5, 59S/H1.5, 59S/H3	
59S/PH1, 59S/PH0, 59S/PH2	

Bitssats med 1/4" standardbits, för Phillips PH2-skrivar 25 mm – 5 st.



59S/PH2PEN

5	13 x 17 x 132 mm	10	59S/PH2PEN

Bitssats med 1/4" standardbits för Pozidriv PZ2-skrivar 25 mm – 5 st.



59S/PZ2PEN

5	13 x 17 x 132 mm	10	59S/PZ2PEN

Bitssats med 1/4" standardbits för TORX®-skruv med centrumpets 25 mm – 5 st.



59S/TORXPEN

5	13 x 17 x 132 mm	10	59S/T15PEN
5	13 x 17 x 132 mm	10	59S/T20PEN
5	13 x 17 x 132 mm	10	59S/T25PEN

1/4" bitssats för Phillips®, Pozidriv® och TORX®-skruv – 60 delar/ displayförpackning



59S/60PEN/DISP

60	140 x 125 x 215 mm	1	59S/60PEN/DISP

59S/T15PENx 5, 59S/T20PENx 30, 59S/T25PENx 5	
59S/PH2PENx 10	
59S/PZ2PENx 10	

5/16" bits för slagskruvmejsel, spårskruv, 41 mm



70S/PH

5	8.0 mm	1	70S/1.2-8.0
2	8.0 mm	25	70S/1.2-8.0-2P
5	9.0 mm	1	70S/1.6-9.0
2	9.0 mm	25	70S/1.6-9.0-2P
5	10.0 mm	1	70S/1.6-10.0
2	10.0 mm	25	70S/1.6-10.0-2P
5	12.0 mm	1	70S/2.0-12.0
2	12.0 mm	25	70S/2.0-12.0-2P
5	14.0 mm	1	70S/2.5-14.0
2	14.0 mm	25	70S/2.5-14.0-2P

5/16" bits för slagskruvmejsel, Phillips®-skruv, 32–38 mm



70S/PH

5	1	1	70S/PH1
2	1	25	70S/PH1-2P
5	2	1	70S/PH2
2	2	25	70S/PH2-2P
5	3	1	70S/PH3
2	3	25	70S/PH3-2P
5	4	1	70S/PH4
2	4	25	70S/PH4-2P

5/16" bits för slagskruvmejsel, Pozidriv®-skruv, 32–38 mm



70S/PZ

5	1	1 70S/PZ1
2	1	25 70S/PZ1-2P
5	2	1 70S/PZ2
2	2	25 70S/PZ2-2P
5	3	1 70S/PZ3
2	3	25 70S/PZ3-2P
5	4	1 70S/PZ4
2	4	25 70S/PZ4-2P

5/16" bits för slagskruvmejsel, Torx®-skruv, 35 mm



70S/T

5	T20	1 70S/T20
2	T20	25 70S/T20-2P
5	T25	1 70S/T25
2	T25	25 70S/T25-2P
5	T27	1 70S/T27
2	T27	1 70S/T27-2P
5	T30	1 70S/T30
2	T30	25 70S/T30-2P
5	T40	1 70S/T40
2	T40	25 70S/T40-2P
5	T45	1 70S/T45
2	T45	25 70S/T45-2P
5	T50	1 70S/T50
2	T50	25 70S/T50-2P
5	T55	1 70S/T55
2	T55	25 70S/T55-2P

5/16" bits för slagskruvmejsel, för Torq-Set®-skruvar, 32 mm



70S/TS

5	8 mm	1 70S/TS8
2	8 mm	25 70S/TS8-2P
5	10 mm	1 70S/TS10
2	10 mm	25 70S/TS10-2P

5/16" bits för slagskruvmejsel, för Torq-Set®-skruvar (tum), 32 mm



70S/TS"

5	1/4"	1 70S/TS1/4
2	1/4"	25 70S/TS1/4-2P
5	5/16"	1 70S/TS5/16
2	5/16"	25 70S/TS5/16-2P

5/16" bits för slagskruvmejsel, insexskruv, 30 mm



70S/H

5	4 mm	1 70S/H4
2	4 mm	25 70S/H4-2P
5	5 mm	1 70S/H5
2	5 mm	25 70S/H5-2P
5	6 mm	1 70S/H6
2	6 mm	25 70S/H6-2P

5	7 mm	1 70S/H7
2	7 mm	25 70S/H7-2P
5	8 mm	1 70S/H8
2	8 mm	25 70S/H8-2P
5	10 mm	1 70S/H10
2	10 mm	25 70S/H10-2P
5	12 mm	1 70S/H12
2	12 mm	25 70S/H12-2P
5	14 mm	1 70S/H14
2	14 mm	25 70S/H14-2P

Slagskruvmejsel för 5/16"-bits med 1/2" fyrkantfäste, 125 mm



5521

125 mm	1 5521

Bitsadapter med sexkantfäste 5/16" för slagskruvmejsel, 40 mm



54640

40 mm	1 54640



1/4" slagskruvmejselssats med bits för Phillips-, Torx®- och insexskruv – 23 delar



7823

23	45 x 70 x 197 mm	16 7823

5521	
54640	
70S/1.2-8.0, 70S/1.6-10.0, 70S/2.0-12.0	
70S/PH2, 70S/PH3, 70S/PH4	
70S/T20, 70S/T25, 70S/T27, 70S/T30, 70S/T40, 70S/T45, 70S/T50, 70S/T55	
70S/H4, 70S/H5, 70S/H6, 70S/H7, 70S/H8, 70S/H10, 70S/H12, 70S/H14	

1/4" slagskruvmejselssats med bits för spår-, Phillips- och insexskruv – 15 delar



7865

15	55 x 90 x 220 mm	1 7865

1 adapter (sekkant 5/16" till 3/82 fyrkant) och 2 spårbits (5, 6 mm) ingår också

5521	
54640	
70S/1.2-8.0, 70S/1.6-10.0	
70S/PH1, 70S/PH2, 70S/PH3, 70S/PH4	
70S/H4, 70S/H5, 70S/H6, 70S/H8	

Gängad bits för Phillips®-skruv



K18

1	2	5 K18NF-2
1	2	5 K18PH-2M5
1	2	5 K18PH-2M6

Gängade bits för Pozidriv®-skruv



K19PZD-2NF

1	2	1 K19PZD-2NF
1	2	1 K19PZD-2M5

Gängade bits för Torx®-skruv, 44,5 mm



K20TORX

1	T25	10 K20TORX-T25

1/4" sexkantshylsa för mutterdragare, omagnetisk



K6750

1	1/4 in	1 K6750-6
1	1/4 in	1 K6750-7
1	1/4 in	1 K6750-8
1	1/4 in	1 K6750-10
1	1/4 in	1 K6750-13
1	1/4 in	1 K6750-1/4
1	1/4 in	1 K6750-3/8

1/4" sexkantshylsa för mutterdragare, magnetisk



KM6750

1	1 KM6750-6
1	1 KM6750-7
1	1 KM6750-8
1	20 KM6750-10
1	1 KM6750-11
1	1 KM6750-13
1	1 KM6750-1/4
1	1 KM6750-3/8

1/4" magnetisk universalbitshållare med sexkantsfäste och snabblossning, 60 mm



KM653-QR

5	1/4"	1 KM653-QR
1	1/4"	50 KM653-QR-1P

1/4" magnetisk universalbitshållare med sexkantsfäste och snabblossning, 75 mm



KM753-QR

1	1/4 in	1	KM753-QR-1P

1/4" magnetisk universalbitshållare med sexkantsfäste, 60 mm



KM653

1	1/4"	25	KM653-1P
5	1/4"	1	KM653

1/4" magnetisk universalbitshållare med sexkantsfäste och låsring, 60 mm



KMR653

1	1/4 in	1	KMR653-1P
5	1/4 in	1	KMR653

1/4 magnetisk universalbitsadapter med sexkantsfäste, 82 mm



KM100-SH

1	1/4"	1	KM100-SH

Krafttorsionsbitshållare 1/4" med snabbfäste



KMT753-QR-1P

1/4 in	1/4 in	50	KMT753-QR-1P		

1/4" magnetisk universalbitshållare med sexkantsfäste och låsring, 75 mm



KMR753

1	1/4 in	1	KMR753-1P
5	1/4 in	1	KMR753

1/4" universalbitshållare med sexkantsfäste och låsring, 60 mm



KR653

1	1/4 in	25	KR653-1P
5	1/4 in	1	KR653

1/4" ledad sexkantsadapter, 65 mm



KM653-SF

1	1/4" in	1	KM653-SF

1/2" universalbitshållare i berylliumkoppar med låsring, 75 mm



KCB753

1	1/4 in	1	KCB753



1/4" magnetisk universalbitshållare med sexkantsfäste och låsring, 150 mm



KMR150

1	1/4 in	1	KMR150-1P
5	1/4 in	1	KMR150

5/16" magnetisk universalbitshållare med sexkantsfäste, 70 mm



KM1/4-5/16-1P

1	1/4 in	50	KM1/4-5/16-1P

1/4" sexkantig hylsadapter för fyrkantfäste, 25 mm – 5 st. i plastask



K6625

1	1/4 in	1	K6625-1/4-1P
5	1/4 in	1	K6625-1/4

1/4" sexkantig hylsadapter för fyrkantfäste, 38 mm – 5 st. i plastask



K6638

1	1/4 in	25	K6638-3/8-1P
5	1/4 in	1	K6638-3/8

1/4" sexkantig hylsadapter för fyrkantfäste, 50 mm – 5 st. i plastask



K6650

1	1/4 in	1	K6650-1/4-1P
5	1/4 in	1	K6650-1/4
1	1/4 in	1	K6650-3/8-1P
5	1/4 in	1	K6650-3/8
1	1/4 in	1	K6650-1/2-1P
5	1/4 in	1	K6650-1/2

1/4" sexkantig hylsadapter för fyrkantfäste, 100 mm – 5 st. i plastask



K66100

1	1/4 in	25	K66100-1/4-1P
5	1/4 in	1	K66100-1/4
1	1/4 in	25	K66100-3/8-1P
5	1/4 in	1	K66100-3/8

1/4" adapter för sexkantsfäste med snabblossning, 60 mm



K6660-QR

1	1/4 in	1	K6660-QR-1P

KRAFTVERKTYG

1/4" krafthylsa med fyrkantfäste och metrisk sexkantsprofil, svartoxiderad yta



K6701M

6 mm	1	K6701M-6
7 mm	1	K6701M-7
8 mm	1	K6701M-8
9 mm	1	K6701M-9
10 mm	1	K6701M-10
11 mm	1	K6701M-11
12 mm	1	K6701M-12
13 mm	1	K6701M-13
14 mm	1	K6701M-14

1/4" sexkantig hylsadapter för fyrkantfäste, 25 mm – 5 st. i plastask



SBK6701M

1	1/4 in	1	SBK6701M-6
5	1/4 in	1	SBK6701M-7
5	1/4 in	1	SBK6701M-8

Sats med krafthylsor med 1/4" fyrkantfäste och metrisk sexkantsprofil, svartoxiderad yta – hängförpackad



SBK6701M

6 mm	1	SBK6701M-6
7 mm	1	SBK6701M-7
8 mm	1	SBK6701M-8

Ø		
9 mm	1	SBK6701M-9
10 mm	1	SBK6701M-10
11 mm	1	SBK6701M-11
12 mm	1	SBK6701M-12
13 mm	1	SBK6701M-13
14 mm	1	SBK6701M-14

Magnetisk 1/4" krafthylsa med fyrkantfäste och metrisk sexkantprofil, svartoxiderad yta



KM6701M

Ø		
7 mm	1	KM6701M-7
8 mm	1	KM6701M-8
10 mm	1	KM6701M-10

Låsring för 1/4" krafthylsa



K560F-1

Ø	Ø	
1/4 in	6-14 mm	5 K560F-1

3/8" krafthylsa med fyrkantfäste och metrisk sexkantprofil, svartoxiderad yta



K7401M

Ø		
7 mm	1	K7401M-7
8 mm	1	K7401M-8
9 mm	1	K7401M-9
10 mm	1	K7401M-10
11 mm	1	K7401M-11
12 mm	1	K7401M-12
13 mm	1	K7401M-13
14 mm	1	K7401M-14
15 mm	1	K7401M-15
16 mm	1	K7401M-16
17 mm	1	K7401M-17
18 mm	1	K7401M-18
19 mm	1	K7401M-19
20 mm	1	K7401M-20
21 mm	1	K7401M-21
22 mm	1	K7401M-22
24 mm	1	K7401M-24

DIN 3129, ISO 2725

Sats med sexkants krafthylsor med 3/8" fyrkantfäste med svartoxiderad yta, i metrisk dimensioner – hängförpackad



SBK7401M

Ø		
7 mm	1	SBK7401M-7
8 mm	1	SBK7401M-8
9 mm	1	SBK7401M-9
10 mm	1	SBK7401M-10
11 mm	1	SBK7401M-11
12 mm	1	SBK7401M-12
13 mm	1	SBK7401M-13
14 mm	1	SBK7401M-14
15 mm	1	SBK7401M-15
16 mm	1	SBK7401M-16
17 mm	1	SBK7401M-17
18 mm	1	SBK7401M-18
19 mm	1	SBK7401M-19
20 mm	1	SBK7401M-20
21 mm	1	SBK7401M-21
22 mm	1	SBK7401M-22
24 mm	1	SBK7401M-24

3/8" långa krafthylsor med fyrkantfäste och metrisk sexkantprofil, svartoxiderad yta



K7406M

Ø		
10 mm	1	K7406M-10
13 mm	1	K7406M-13
17 mm	1	K7406M-17

3/8" sexkants krafthylsa med fyrkantfäste, tum-skala



K7401Z

Ø		
3/8 in	1	K7401Z-3/8
7/16 in	1	K7401Z-7/16
1/2 in	1	K7401Z-1/2
9/16 in	1	K7401Z-9/16
5/8 in	1	K7401Z-5/8
11/16 in	1	K7401Z-11/16
3/4 in	1	K7401Z-3/4
13/16 in	1	K7401Z-13/16
7/8 in	1	K7401Z-7/8

3/8" fyrkantfäste till 1/4" bitshållaradapter



K172

Ø		
1/4"	1	K172



3/8" hylsa med fyrkantsfäste för bits 1/4", svartoxiderad yta



7407H-7409H

1/4"	3/8"	1	7407H
5/16"	3/8"	1	7408H
11	3/8"	1	7409H

3/8" krafthylsa med fyrkantsfäste och Torx®-profil, svartoxiderad yta



K7401TORX-E

E5	M4	1	K7401TORX-E5
E6	M5	1	K7401TORX-E6
E7	M6	1	K7401TORX-E7
E8	M6, M7	1	K7401TORX-E8
E10	M6, M8	1	K7401TORX-E10
E12	M8, M10	1	K7401TORX-E12
E14	M10, M12	1	K7401TORX-E14

3/8" ledad sexkants krafthylsa med fyrkantsfäste, metrisk



KS7401M

3/8 in	1	KS7401M-9
3/8 in	1	KS7401M-10
3/8 in	1	KS7401M-11
3/8 in	1	KS7401M-12
3/8 in	1	KS7401M-13
3/8 in	1	KS7401M-14
3/8 in	1	KS7401M-15

3/8 in	1	KS7401M-16
3/8 in	1	KS7401M-17
3/8 in	1	KS7401M-18
3/8 in	1	KS7401M-19
3/8 in	1	KS7401M-22

3/8" universalknut med fyrkantsfäste, svartoxiderad yta



K7767S

3/8"	3/8"	1	K7767S
------	------	---	--------

3/8" mellanstycke med fyrkantsfäste, svartoxiderad yta



K6964C

1/4"	3/8"	1	K6964C
------	------	---	--------

Mellanstycke med 3/8" och fyrkantsfäste, svartoxiderad yta



K8164C

1/2"	3/8"	1	K8164C
------	------	---	--------

3/8" förlängare med fyrkantsfäste, svartoxiderad yta



K7760C

75 mm	1	K7760C-1
150 mm	1	K7760C-2

Låsring för 3/8" krafthylsa



K560F-2/3

3/8"	7-12	5	K560F-2
3/8"	13-24	5	K560F-3

Sats med sexkants krafthylsor i metrisk dimensioner – 10 st.



K7401M/10

10	1	K7401M/10
----	---	-----------

K7401M-10, K7401M-11, K7401M-12, K7401M-13, K7401M-14, K7401M-15, K7401M-16, K7401M-17, K7401M-18, K7401M-19

Sats med 3/8" krafthylsor med fyrkantfäste och Torx®-profil, svartoxiderad yta – 7 delar



K7401TORX-E-S7



7 1 K7401TORX-E-S7

K7401TORX-E5, K7401TORX-E6, K7401TORX-E7, K7401TORX-E8, K7401TORX-E10, K7401TORX-E12, K7401TORX-E14



1/2" extra kort krafthylsa med fyrkantfäste och metrisk sexkantprofil, svartoxiderad yta



K7800M



10 mm	1	K7800M-10
11 mm	1	K7800M-11
12 mm	1	K7800M-12
13 mm	1	K7800M-13
14 mm	1	K7800M-14
15 mm	1	K7800M-15
16 mm	1	K7800M-16
17 mm	1	K7800M-17
18 mm	1	K7800M-18
19 mm	1	K7800M-19
21 mm	1	K7800M-21
22 mm	1	K7800M-22
24 mm	1	K7800M-24

1/2" krafthylsa med fyrkantfäste och metrisk sexkantprofil, svartoxiderad yta



K7801M



8 mm	1	K7801M-8
9 mm	1	K7801M-9
10 mm	1	K7801M-10
11 mm	1	K7801M-11
12 mm	1	K7801M-12
13 mm	1	K7801M-13
14 mm	1	K7801M-14
15 mm	1	K7801M-15
16 mm	1	K7801M-16
17 mm	1	K7801M-17
18 mm	1	K7801M-18
19 mm	1	K7801M-19
20 mm	1	K7801M-20
21 mm	1	K7801M-21
22 mm	1	K7801M-22
23 mm	1	K7801M-23
24 mm	1	K7801M-24
25 mm	1	K7801M-25
26 mm	1	K7801M-26
27 mm	1	K7801M-27
28 mm	1	K7801M-28
29 mm	1	K7801M-29
30 mm	1	K7801M-30
32 mm	15	K7801M-32
34 mm	1	K7801M-34
36 mm	1	K7801M-36

Sats med sexkants krafthylsor med 1/2" fyrkantfäste med svartoxiderad yta, i metriska dimensioner – hängförpackad



SBK7801M



8 mm	1	SBK7801M-8
9 mm	1	SBK7801M-9
10 mm	1	SBK7801M-10
11 mm	1	SBK7801M-11



12 mm	1	SBK7801M-12
13 mm	1	SBK7801M-13
14 mm	1	SBK7801M-14
15 mm	1	SBK7801M-15
16 mm	1	SBK7801M-16
17 mm	1	SBK7801M-17
18 mm	1	SBK7801M-18
19 mm	1	SBK7801M-19
20 mm	1	SBK7801M-20
21 mm	1	SBK7801M-21
22 mm	1	SBK7801M-22
23 mm	1	SBK7801M-23
24 mm	1	SBK7801M-24
25 mm	1	SBK7801M-25
26 mm	1	SBK7801M-26
27 mm	1	SBK7801M-27
28 mm	1	SBK7801M-28
29 mm	1	SBK7801M-29
30 mm	1	SBK7801M-30
32 mm	1	SBK7801M-32
34 mm	1	SBK7801M-34
36 mm	1	SBK7801M-36

1/2" lång krafthylsa med fyrkantfäste och metrisk sexkantprofil, svartoxiderad yta



K7806M



10 mm	1	K7806M-10
11 mm	1	K7806M-11
12 mm	1	K7806M-12
13 mm	1	K7806M-13
14 mm	1	K7806M-14
15 mm	1	K7806M-15
16 mm	1	K7806M-16
17 mm	1	K7806M-17
18 mm	1	K7806M-18
19 mm	1	K7806M-19
21 mm	1	K7806M-21
22 mm	1	K7806M-22
23 mm	1	K7806M-23
24 mm	1	K7806M-24
27 mm	1	K7806M-27
30 mm	1	K7806M-30
32 mm	1	K7806M-32
36 mm	1	K7806M-36

SB: Hängförpackade



Sexkant krafthylsa, 1/2", lång, i metrisk dimensioner, fosfaterad yta-hängförpackning



SBK7806M

Ø		
10 mm	1	SBK7806M-10
11 mm	1	SBK7806M-11
12 mm	1	SBK7806M-12
13 mm	1	SBK7806M-13
14 mm	1	SBK7806M-14
15 mm	1	SBK7806M-15
16 mm	1	SBK7806M-16
17 mm	1	SBK7806M-17
18 mm	1	SBK7806M-18
19 mm	1	SBK7806M-19
21 mm	1	SBK7806M-21
22 mm	1	SBK7806M-22
23 mm	1	SBK7806M-23
24 mm	1	SBK7806M-24
27 mm	1	SBK7806M-27
30 mm	1	SBK7806M-30
32 mm	1	SBK7806M-32
36 mm	1	SBK7806M-36

SB: Retail pack on a plastic info card

Förstärkt 1/2"-krafthylsa med fyrkantfäste och metrisk sexkantprofil, svartoxiderad yta



K7801VM

Ø		
17 mm	1	K7801VM-17
19 mm	1	K7801VM-19
22 mm	1	K7801VM-22
24 mm	1	K7801VM-24

1/2" krafthylsa med fyrkantfäste och sexkantprofil, svartoxiderad yta, tum-dimensioner



K7801Z

Ø		
3/8 in	1	K7801Z-3/8
7/16 in	1	K7801Z-7/16
1/2 in	1	K7801Z-1/2
9/16 in	1	K7801Z-9/16
5/8 in	1	K7801Z-5/8
11/16 in	1	K7801Z-11/16
3/4 in	1	K7801Z-3/4
13/16 in	1	K7801Z-13/16
7/8 in	1	K7801Z-7/8
15/16 in	1	K7801Z-15/16
1 in	1	K7801Z-1
1 1/16 in	1	K7801Z-1.1/16
1 1/8 in	1	K7801Z-1.1/8
1 1/4 in	1	K7801Z-1.1/4
1 5/16 in	5	K7801Z-1.5/16
1 3/8 in	5	K7801Z-1.3/8
1 7/16 in	5	K7801Z-1.7/16
1 1/2 in	5	K7801Z-1.1/2

Sexkant krafthylsa, 1/2" i tum-dimensioner, fosfaterad yta-hängförpackning



SBK7801Z

Ø		
3/8 in	1	SBK7801Z-3/8
7/16 in	1	SBK7801Z-7/16
1/2 in	1	SBK7801Z-1/2
9/16 in	1	SBK7801Z-9/16
5/8 in	1	SBK7801Z-5/8
11/16 in	1	SBK7801Z-11/16
3/4 in	1	SBK7801Z-3/4
13/16 in	1	SBK7801Z-13/16
7/8 in	1	SBK7801Z-7/8
15/16 in	1	SBK7801Z-15/16
1 in	1	SBK7801Z-1
1 1/16 in	1	SBK7801Z-1.1/16
1 1/8 in	1	SBK7801Z-1.1/8
1 1/4 in	1	SBK7801Z-1.1/4
1 5/16 in	1	SBK7801Z-1.5/16
1 3/8 in	1	SBK7801Z-1.3/8
1 7/16 in	1	SBK7801Z-1.7/16
1 1/2 in	1	SBK7801Z-1.1/2

SB: Retail pack on a plastic info card

Lång 1/2"-krafthylsa med fyrkantfäste och sexkantprofil i tum-dimensioner, svartoxiderad yta



K7806Z

Ø		
3/8 in	10	K7806Z-3/8
7/16 in	5	K7806Z-7/16
1/2 in	10	K7806Z-1/2
9/16 in	10	K7806Z-9/16
5/8 in	5	K7806Z-5/8
11/16 in	5	K7806Z-11/16
3/4 in	5	K7806Z-3/4
13/16 in	5	K7806Z-13/16
7/8 in	5	K7806Z-7/8
15/16 in	5	K7806Z-15/16
1 in	5	K7806Z-1
1 1/16 in	5	K7806Z-1.1/16
1 1/8 in	5	K7806Z-1.1/8
1 1/4 in	5	K7806Z-1.1/4
1 5/16 in	5	K7806Z-1.5/16
1 3/8 in	5	K7806Z-1.3/8
1 7/16 in	5	K7806Z-1.7/16
1 1/2 in	5	K7806Z-1.1/2

SB: Hängförpackade

Sexkant krafthylsa, 1/2", lång, i tum-dimensioner, fosfaterad yta-hängförpackning



SBK7806Z

Ø		
3/8 in	10	SBK7806Z-3/8
7/16 in	10	SBK7806Z-7/16
1/2 in	10	SBK7806Z-1/2
9/16 in	10	SBK7806Z-9/16
5/8 in	5	SBK7806Z-5/8
11/16 in	1	SBK7806Z-11/16
3/4 in	1	SBK7806Z-3/4
13/16 in	1	SBK7806Z-13/16
7/8 in	1	SBK7806Z-7/8
15/16 in	1	SBK7806Z-15/16
1 in	1	SBK7806Z-1
1 1/16 in	1	SBK7806Z-1.1/16
1 1/8 in	5	SBK7806Z-1.1/8
1 1/4 in	1	SBK7806Z-1.1/4
1 5/16 in	1	SBK7806Z-1.5/16
1 3/8 in	5	SBK7806Z-1.3/8
1 7/16 in	5	SBK7806Z-1.7/16
1 1/2 in	1	SBK7806Z-1.1/2

SB: Retail pack on a plastic info card

Kraftbitshylsa med 1/2" fäste för insexskruv, svart yta



7993S



5 mm	1	7993S0050
6 mm	1	7993S0060
8 mm	1	7993S0080
10 mm	1	7993S0100
12 mm	1	7993S0120
14 mm	1	7993S0140
17 mm	1	7993S0170
18 mm	1	7993S0180
19 mm	1	7993S0190

1/2" sats med krafthylsor med fyrkantfäste för Torx®-skruv, svartoxiderad yta



7994S



T20	1	7994S0200
T25	1	7994S0250
T27	1	7994S0270
T-30	1	7994S0300
T-40	1	7994S0400
T-45	1	7994S0450
T-50	1	7994S0500
T-55	1	7994S0550
T-60	1	7994S0600

1/2" krafthylsa med fyrkantfäste och Torx®-profil, svartoxiderad yta



K7801TORX-E



E10	1	K7801TORX-E10
E12	1	K7801TORX-E12



E14	1	K7801TORX-E14
E16	1	K7801TORX-E16
E18	1	K7801TORX-E18
E20	1	K7801TORX-E20
E24	1	K7801TORX-E24

1/2" bitshållare med fyrkantfäste, svartoxiderad yta



7807H-7809H



1/2"	1/4 in	1	7807H
1/2"	5/16 in	1	7808H
1/2"	11.2 mm	1	7809H
1/2"	1/4 in	1	SB7807H
1/2"	5/16 in	1	SB7808H
1/2"	7/16 in	1	SB7809H

1/2" förlängare med fyrkantfäste, svartoxiderad yta



K8160D



75 mm	1	K8160D-1
125 mm	1	K8160D-2
250 mm	1	K8160D-3
75 mm	1	SBK8160D-1
125 mm	1	SBK8160D-2
250 mm	1	SBK8160D-3

1/2" universalknut med fyrkantfäste, svartoxiderad yta



K8167S



1/2"	1/2"	1	K8167S
------	------	---	--------

1/2" mellanstycke med fyrkantfäste, svartoxiderad yta



K7764D/SBK7764D



M 3/8"	F 1/2"	1	K7764D
M 3/8"	F 1/2"	1	SBK7764D

SB: Hängförpackade

Adapter, mellanstycke 3/4" till 1/2" med fyrkantfäste och svartoxiderad yta



K8964D/SBK8964D



3/4"	1/2"	1	K8964D
M 3/4"	F 1/2"	1	SBK8964D

SB: Hängförpackade



Låsring för 1/2" krafthylsa



K560F-4/5

1/2"	10-14 mm	5	K560F-4
1/2"	15-32 mm	5	K560F-5

Krafthylssats 1/2" korta hylsor, 13 delar



K7800M/13

43 x 128 x 195 mm	1	K7800M/13

K7800M-10, K7800M-11, K7800M-12, K7800M-13, K7800M-14, K7800M-15, K7800M-16, K7800M-17, K7800M-18, K7800M-19, K7800M-21, K7800M-22, K7800M-24

4750IB-A5

Sats med 1/2" långa krafthylsor med fyrkantfäste och metrisk sexkantprofil, svartoxiderad yta – 4 delar



K7806M/S4

4	1	K7806M/S4

K7806M-19, K7806M-22, K7806M-17, K7806M-24

4750IB-A5

Sats med 1/2" förstärkta krafthylsor med fyrkantfäste och metrisk sexkantprofil, svartoxiderad yta – 4 delar



K7801VM/S4

4	1	K7801VM/S4

K7801VM-22, K7801VM-19, K7801VM-17, K7801VM-24

Sats med 1/2" krafthylsor med fyrkantfäste och sexkantprofil med tumskala, svartoxiderad yta – 10 delar



K7801Z/10

10	60 x 220 x 280 mm	1	K7801Z/10

K7801Z-7/16, K7801Z-1/2, K7801Z-11/16, K7801Z-5/8, K7801Z-13/16, K7801Z-3/4, K7801Z-15/16, K7801Z-7/8, K7801Z-1, K7801Z-9/16

Sats med 1/2" långa krafthylsor med fyrkantfäste och sexkantprofil i tumdimensioner, svartoxiderad yta – 10 delar



K7806Z/10

10	60 x 220 x 280 mm	1	K7806Z/10

K7806Z-7/16, K7806Z-1/2, K7806Z-9/16, K7806Z-3/4, K7806Z-13/16, K7806Z-11/16, K7806Z-1, K7806Z-7/8, K7806Z-15/16, K7806Z-5/8

1/2" långa krafthylsor med fyrkantfäste och sexkantprofil, svartoxiderad yta – 14 delar



DD/S14

14	4	DD/S14

K7806M-10, K7806M-11, K7806M-12, K7806M-13, K7806M-14, K7806M-15, K7806M-16, K7806M-17, K7806M-18, K7806M-19, K7806M-21, K7806M-22, K7806M-24, K7806M-27

Sats med 1/2" krafthylsor med fyrkantfäste och metrisk sexkantprofil, svartoxiderad yta – 20 delar



D-DD/

20	4	D-DD/S20

K7801M-14, K7801M-15, K7801M-16, K7801M-11, K7801M-10, K7801M-13, K7801M-12, K7801M-18, K7801M-19, K7801M-17

K7806M-19, K7806M-17, K7806M-18, K7806M-14, K7806M-16, K7806M-12, K7806M-13, K7806M-10, K7806M-11

Sats med 1/2" krafthylsor med fyrkantfäste och metrisk sexkantprofil, svartoxiderad yta – 10 delar



D/

10	6	D/S10

K7801M-10, K7801M-11, K7801M-12, K7801M-13, K7801M-14, K7801M-15, K7801M-16, K7801M-17, K7801M-18, K7801M-19

Sats med 1/2" krafthylsor med fyrkantfäste och metrisk sexkantprofil, svartoxiderad yta – 14 delar



D/S14

14	6	D/S14

K7801M-10, K7801M-11, K7801M-12, K7801M-13, K7801M-14, K7801M-15, K7801M-16, K7801M-17, K7801M-18, K7801M-19, K7801M-21, K7801M-22, K7801M-24, K7801M-27

Sats med 1/2" långa krafthylsor med fyrkantfäste och metrisk sexkantprofil, svartoxiderad yta – 10 delar



DD/

10	6	DD/S10

K7806M-10, K7806M-11, K7806M-12, K7806M-13, K7806M-14, K7806M-15, K7806M-16, K7806M-17, K7806M-18, K7806M-19

3/4" krafthylsa med fyrkantfäste och metrisk sexkantprofil, svartoxiderad yta



K8901M

17 mm	1	K8901M-17
18 mm	1	K8901M-18
19 mm	1	K8901M-19
21 mm	1	K8901M-21
22 mm	1	K8901M-22
23 mm	1	K8901M-23
24 mm	1	K8901M-24
27 mm	1	K8901M-27
28 mm	1	K8901M-28
29 mm	1	K8901M-29
30 mm	1	K8901M-30
32 mm	1	K8901M-32
33 mm	1	K8901M-33
34 mm	1	K8901M-34
36 mm	1	K8901M-36
38 mm	1	K8901M-38
41 mm	1	K8901M-41
46 mm	1	K8901M-46
50 mm	1	K8901M-50
55 mm	1	K8901M-55
60 mm	1	K8901M-60

SB: Hängförpackade

3/4" krafthylsa med fyrkantfäste och metrisk sexkantprofil, svartoxiderad yta – Detaljhandelspaket



SBK8901M

17 mm	1	SBK8901M-17
18 mm	1	SBK8901M-18
19 mm	1	SBK8901M-19
21 mm	1	SBK8901M-21
22 mm	1	SBK8901M-22
23 mm	1	SBK8901M-23
24 mm	1	SBK8901M-24
27 mm	1	SBK8901M-27
28 mm	1	SBK8901M-28
29 mm	1	SBK8901M-29
30 mm	1	SBK8901M-30
32 mm	1	SBK8901M-32
33 mm	1	SBK8901M-33
34 mm	1	SBK8901M-34
36 mm	1	SBK8901M-36
38 mm	1	SBK8901M-38
41 mm	1	SBK8901M-41
46 mm	1	SBK8901M-46
55 mm	1	SBK8901M-55
60 mm	1	SBK8901M-60
50 mm	1	SBK8901M-50

SB: Hängförpackade

3/4" lång krafthylsa med fyrkantfäste och metrisk sexkantprofil, svartoxiderad yta



K8906M

17 mm	1	K8906M-17
19 mm	1	K8906M-19
21 mm	1	K8906M-21
22 mm	1	K8906M-22
24 mm	1	K8906M-24
27 mm	1	K8906M-27
30 mm	1	K8906M-30
32 mm	1	K8906M-32
33 mm	1	K8906M-33
34 mm	1	K8906M-34
36 mm	1	K8906M-36
41 mm	1	K8906M-41
46 mm	1	K8906M-46

SB: Hängförpackade



3/4" krafthylsa med fyrkantsfäste och sexkantsprofil, svartoxiderad yta, tumdimensioner



K8901Z



11/16 in	1	K8901Z-11/16
3/4 in	1	K8901Z-3/4
13/16 in	1	K8901Z-13/16
7/8 in	1	K8901Z-7/8
15/16 in	1	K8901Z-15/16
1 in	1	K8901Z-1
1 1/16 in	1	K8901Z-1.1/16
1 1/8 in	1	K8901Z-1.1/8
1 3/16 in	1	K8901Z-1.3/16
1 1/4 in	1	K8901Z-1.1/4
1 5/16 in	1	K8901Z-1.5/16
1 3/8 in	1	K8901Z-1.3/8
1 7/16 in	1	K8901Z-1.7/16
1 1/2 in	1	K8901Z-1.1/2
1 9/16 in	1	K8901Z-1.9/16
1 5/8 in	1	K8901Z-1.5/8
1 11/16 in	1	K8901Z-1.11/16
1 3/4 in	1	K8901Z-1.3/4
1 13/16 in	1	K8901Z-1.13/16
1 7/8 in	1	K8901Z-1.7/8
1 15/16 in	1	K8901Z-1.15/16
2 in	1	K8901Z-2
2 1/16 in	1	K8901Z-2.1/16
2 3/16 in	1	K8901Z-2.3/16
2 1/4 in	1	K8901Z-2.1/4
2 3/8 in	1	K8901Z-2.3/8

SB: Hängförpackade

Lång 3/4" krafthylsa med fyrkantsfäste och sexkantsprofil med tum-skala, svartoxiderad yta



K8906Z



3/4 in	1	K8906Z-3/4
13/16 in	1	K8906Z-13/16
7/8 in	1	K8906Z-7/8
15/16 in	1	K8906Z-15/16



1 mm	1	K8906Z-1
1 1/16 in	1	K8906Z-1.1/16
1 1/8 in	1	K8906Z-1.1/8
1 1/4 in	1	K8906Z-1.1/4
1 5/16 in	1	K8906Z-1.5/16
1 3/8 in	1	K8906Z-1.3/8
1 7/16 in	1	K8906Z-1.7/16
1 1/2 in	1	K8906Z-1.1/2
1 5/8 in	1	K8906Z-1.5/8
1 3/4 in	1	K8906Z-1.3/4
2 mm	1	K8906Z-2

SB: Hängförpackade

3/4" kraftbitshylsor med fyrkantsfäste, för insexskruv, svartoxiderad yta



7993T



12 mm	1	7993T0120
14 mm	1	7993T0140
17 mm	1	7993T0170
19 mm	1	7993T0190
22 mm	1	7993T0220
24 mm	1	7993T0240

3/4" bitshållare med fyrkantsfäste, svartoxiderad yta



K8909H



22 mm	3/4"	1	K8909H-5
-------	------	---	----------

3/4" universalknut med fyrkantsfäste, svartoxiderad yta



K8967S



3/4"	3/4"	1	K8967S
------	------	---	--------

3/4" mellanstycke med fyrkantsfäste, svartoxiderad yta



K8164F



1/2"	3/4"	1	K8164F
------	------	---	--------

Adapter, mellanstycke 1" till 3/4" med fyrkantsfäste och svartoxiderad yta



K9564F



1"	3/4"	1	K9564F
----	------	---	--------

3/4" förlängare med fyrkantsfäste, svartoxiderad yta



K8960F



175 mm	1	K8960F-2
250 mm	1	K8960F-3
325 mm	1	K8960F-4

Låsring för 3/4" krafthylsa



K560F-6



3/4"	17-46 mm	5	K560F-6
------	----------	---	---------

Sats med 3/4" krafthylsor med fyrkantsfäste och metrisk sexkantsprofil, svartoxiderad yta – 8 delar



K8901M/8



8	65 x 240 x 350 mm	1	K8901M/8
---	-------------------	---	----------

K8901M-27, K8901M-24, K8901M-21, K8901M-22, K8901M-30, K8901M-32, K8901M-36, K8901M-41

Sats med 3/4" långa krafthylsor med fyrkantsfäste och metrisk sexkantsprofil, svartoxiderad yta – 8 delar



K8906M/8



8	80 x 250 x 315 mm	1	K8906M/8
---	-------------------	---	----------

K8906M-24, K8906M-27, K8906M-30, K8906M-41, K8906M-36, K8906M-21, K8906M-22, K8906M-32

Sats med 3/4" krafthylsor med fyrkantsfäste och sexkantsprofil i tum-dimensioner, svartoxiderad yta – 8 delar



K8901Z/8



8	80 x 250 x 310 mm	1	K8901Z/8
---	-------------------	---	----------

K8901Z-1.1/16, K8901Z-1, K8901Z-1.3/8, K8901Z-1.5/16, K8901Z-1.1/4, K8901Z-1.1/2, K8901Z-1.7/16, K8901Z-1.1/8

Sats med sexkants krafthylsor med 3/4" fyrkantsfäste med svartoxiderad yta, i tum-dimensioner – 18 delar



K8901Z/18



18	100 x 210 x 595 mm	1	K8901Z/18
----	--------------------	---	-----------

K8901Z-11/16, K8901Z-3/4, K8901Z-13/16, K8901Z-7/8, K8901Z-15/16, K8901Z-1, K8901Z-1.1/16, K8901Z-1.1/8, K8901Z-1.3/16, K8901Z-1.1/4, K8901Z-1.5/16, K8901Z-1.3/8, K8901Z-1.7/16, K8901Z-1.1/2, K8901Z-1.9/16, K8901Z-1.5/8, K8901Z-1.11/16, K8901Z-1.3/4

Sats med 3/4" långa krafthylsor med fyrkantsfäste och sexkantsprofil med tum-skala, svartoxiderad yta – 8 delar



K8906Z/8



8	125 x 250 x 110 mm	1	K8906Z/8
---	--------------------	---	----------

K8906Z-1, K8906Z-1.1/16, K8906Z-1.1/8, K8906Z-1.1/4, K8906Z-1.5/16, K8906Z-1.3/8, K8906Z-1.7/16, K8906Z-1.1/2



1" krafthylsa med fyrkantfäste och metrisk sexkantprofil, svartoxiderad yta



K9501M



22 mm	1	K9501M-22
24 mm	1	K9501M-24
27 mm	1	K9501M-27
30 mm	1	K9501M-30
32 mm	1	K9501M-32
33 mm	1	K9501M-33
34 mm	1	K9501M-34
36 mm	1	K9501M-36
38 mm	1	K9501M-38
41 mm	1	K9501M-41
42 mm	1	K9501M-42
46 mm	1	K9501M-46
50 mm	1	K9501M-50
55 mm	1	K9501M-55
60 mm	1	K9501M-60
65 mm	1	K9501M-65
70 mm	1	K9501M-70
75 mm	1	K9501M-75
80 mm	1	K9501M-80
85 mm	1	K9501M-85

1" krafthylsa med fyrkantfäste och sexkantprofil, svartoxiderad yta, tumskala



K9501Z



1 in	1	K9501Z-1
1 1/16 in	1	K9501Z-1.1/16
1 1/8 in	1	K9501Z-1.1/8
1 3/16 in	1	K9501Z-1.3/16
1 1/4 in	1	K9501Z-1.1/4
1 5/16 in	1	K9501Z-1.5/16
1 3/8 in	1	K9501Z-1.3/8
1 7/16 in	1	K9501Z-1.7/16
1 1/2 in	1	K9501Z-1.1/2
1 9/16 in	1	K9501Z-1.9/16
1 5/8 in	1	K9501Z-1.5/8
1 11/16 in	1	K9501Z-1.11/16
1 3/4 in	1	K9501Z-1.3/4
1 13/16 in	1	K9501Z-1.13/16
1 7/8 in	1	K9501Z-1.7/8
15/16 in	1	K9501Z-1.15/16
2 in	1	K9501Z-2
2 1/8 in	1	K9501Z-2.1/8
2 3/16 in	1	K9501Z-2.3/16
2 1/4 in	1	K9501Z-2.1/4
2 5/16 in	1	K9501Z-2.5/16
2 9/16 in	1	K9501Z-2.9/16
2 3/4 in	1	K9501Z-2.3/4

1" bitshållare med fyrkantfäste, 22 mm sexkantfäste med svartoxiderad yta



K9509H5

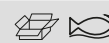

22 mm	1"	1	K9509H5
-------	----	---	---------

1" sats med bitshylsor med fyrkantfäste för insexskruv, svart yta



7993M



17 mm	1	7993M0170
19 mm	1	7993M0190
22 mm	1	7993M0220
27 mm	1	7993M0270

1" lång krafthylsa med fyrkantfäste och metrisk sexkantprofil, svartoxiderad yta



K9506M



22 mm	1	K9506M-22
24 mm	1	K9506M-24
27 mm	1	K9506M-27
30 mm	1	K9506M-30
32 mm	1	K9506M-32
33 mm	1	K9506M-33
34 mm	1	K9506M-34
36 mm	1	K9506M-36
38 mm	1	K9506M-38
41 mm	1	K9506M-41
46 mm	1	K9506M-46
50 mm	1	K9506M-50
55 mm	1	K9506M-55
60 mm	1	K9506M-60

Lång 1" krafthylsa med fyrkantfäste och sexkantprofil i tum-dimensioner, svartoxiderad yta



K9506Z



1 in	1	K9506Z-1
1 1/16 in	1	K9506Z-1.1/16
1 3/16 in	1	K9506Z-1.3/16
1 1/4 in	1	K9506Z-1.1/4
1 7/16 in	1	K9506Z-1.7/16
1 1/2 in	1	K9506Z-1.1/2
1 5/8 in	1	K9506Z-1.5/8
1 13/16 in	1	K9506Z-1.13/16
1 7/8 in	1	K9506Z-1.7/8

1" mellanstycke med fyrkantfäste, svartoxiderad yta



K8964G



3/4"	1"	1	K8964G
------	----	---	--------

Adapter, mellanstycke 1" till 1-1/2" med fyrkantfäste och svartoxiderad yta



K9895G

1 1/2"	1"	1	K9895G

1" förlängare med fyrkantfäste, svartoxiderad yta



K9560G

100 mm	1	K9560G-0
125 mm	1	K9560G-1
175 mm	1	K9560G-2
325 mm	1	K9560G-3
300 mm	1	K9560G-4
400 mm	1	K9560G-5

1" universalknut med fyrkantfäste, svartoxiderad yta



K9567S

1"	1"	1	K9567S

Bits med 22 mm utvärdig sexkant



K8909ML/K9509ML

12 mm	1	K8909ML-12
14 mm	1	K8909ML-14
17 mm	1	K8909ML-17
19 mm	1	K9509ML-19
22 mm	1	K9509ML-22
24 mm	1	K9509ML-24

Låsring för 1" och 1-1/2" krafthylsa



K560F-7/8

1"	19-70 mm	5	K560F-7
1 & 1/2"	75-80 & 46-90 mm	5	K560F-8

1-1/2" krafthylsa med fyrkantfäste och metrisk sexkantsprofil, svartoxiderad yta



K9801M

46 mm	1	K9801M-46
50 mm	1	K9801M-50
55 mm	1	K9801M-55

60 mm	1	K9801M-60
65 mm	1	K9801M-65
70 mm	1	K9801M-70
75 mm	1	K9801M-75
80 mm	1	K9801M-80
85 mm	1	K9801M-85
90 mm	1	K9801M-90
95 mm	1	K9801M-95
100 mm	1	K9801M-100
105 mm	1	K9801M-105
110 mm	1	K9801M-110
115 mm	1	K9801M-115
120 mm	1	K9801M-120
125 mm	1	K9801M-125
130 mm	1	K9801M-130
135 mm	1	K9801M-135
140 mm	1	K9801M-140
145 mm	1	K9801M-145
150 mm	1	K9801M-150
155 mm	1	K9801M-155

1-1/2" lång krafthylsa med fyrkantfäste och metrisk sexkantsprofil, svartoxiderad yta



K9806M

41 mm	1	K9806M-41
46 mm	1	K9806M-46
50 mm	1	K9806M-50
55 mm	1	K9806M-55
60 mm	1	K9806M-60
65 mm	1	K9806M-65
70 mm	1	K9806M-70
75 mm	1	K9806M-75
80 mm	1	K9806M-80
85 mm	1	K9806M-85
90 mm	1	K9806M-90
95 mm	1	K9806M-95
100 mm	1	K9806M-100
105 mm	1	K9806M-105
110 mm	1	K9806M-110
115 mm	1	K9806M-115
120 mm	1	K9806M-120



1-1/2" krafthylsa med fyrkantfäste och sexkantprofil, svartoxiderad yta, tumskala



K9801Z



1 3/8 in	1	K9801Z-1.3/8
1 7/16 in	1	K9801Z-1.7/16
1 1/2 in	1	K9801Z-1.1/2
1 9/16 in	1	K9801Z-1.9/16
1 5/8 in	1	K9801Z-1.5/8
1 11/16 in	1	K9801Z-1.11/16
1 3/4 in	1	K9801Z-1.3/4
1 13/16 in	1	K9801Z-1.13/16
1 7/8 in	1	K9801Z-1.7/8
1 15/16 in	1	K9801Z-1.15/16
2 in	1	K9801Z-2
2 1/16 in	1	K9801Z-2.1/16
2 1/8 in	1	K9801Z-2.1/8
2 3/16 in	1	K9801Z-2.3/16
2 1/4 in	1	K9801Z-2.1/4
2 5/16 in	1	K9801Z-2.5/16
2 3/8 in	1	K9801Z-2.3/8
2 7/16 in	1	K9801Z-2.7/16
2 1/2 in	1	K9801Z-2.1/2
2 9/16 in	1	K9801Z-2.9/16
2 5/8 in	1	K9801Z-2.5/8
2 11/16 in	1	K9801Z-2.11/16
2 3/4 in	1	K9801Z-2.3/4
2 13/16 in	1	K9801Z-2.13/16
2 7/8 in	1	K9801Z-2.7/8
2 15/16 in	1	K9801Z-2.15/16
3 in	1	K9801Z-3
3 1/16 in	1	K9801Z-3.1/16
3 1/8 in	1	K9801Z-3.1/8
3 1/4 in	1	K9801Z-3.1/4
3 5/16 in	1	K9801Z-3.5/16
3 3/8 in	1	K9801Z-3.3/8
3 7/16 in	1	K9801Z-3.7/16
3 1/2 in	1	K9801Z-3.1/2
3 9/16 in	1	K9801Z-3.9/16
3 5/8 in	1	K9801Z-3.5/8
3 11/16 in	1	K9801Z-3.11/16
3 3/4 in	1	K9801Z-3.3/4
3 13/16 in	1	K9801Z-3.13/16
3 7/8 in	1	K9801Z-3.7/8
3 15/16 in	1	K9801Z-3.15/16
4 in	1	K9801Z-4
4 1/16 in	1	K9801Z-4.1/16
4 1/8 in	1	K9801Z-4.1/8
4 1/4 in	1	K9801Z-4.1/4
4 5/16 in	1	K9801Z-4.5/16
4 3/8 in	1	K9801Z-4.3/8
4 7/16 in	1	K9801Z-4.7/16
4 1/2 in	1	K9801Z-4.1/2
4 5/8 in	1	K9801Z-4.5/8
4 3/4 in	1	K9801Z-4.3/4

Lång 1-1/2"-krafthylsa med fyrkantfäste och sexkantprofil i tum-dimensioner, svartoxiderad yta



K9806Z



1 3/8 in	1	K9806Z-1.3/8
1 7/16 in	1	K9806Z-1.7/16
1 1/2 in	1	K9806Z-1.1/2
1 5/8 in	1	K9806Z-1.5/8
1 11/16 in	1	K9806Z-1.11/16
2 in	1	K9806Z-2
2 1/16 in	1	K9806Z-2.1/16
2 3/16 in	1	K9806Z-2.3/16
2 1/4 in	1	K9806Z-2.1/4
2 5/16 in	1	K9806Z-2.5/16
2 3/8 in	1	K9806Z-2.3/8
2 7/16 in	1	K9806Z-2.7/16
2 1/2 in	1	K9806Z-2.1/2
2 9/16 in	1	K9806Z-2.9/16
2 5/8 in	1	K9806Z-2.5/8
2 11/16 in	1	K9806Z-2.11/16
2 3/4 in	1	K9806Z-2.3/4
2 13/16 in	1	K9806Z-2.13/16
2 7/8 in	1	K9806Z-2.7/8
2 15/16 in	1	K9806Z-2.15/16
3 in	1	K9806Z-3
3 1/16 in	1	K9806Z-3.1/16
3 1/8 in	1	K9806Z-3.1/8
3 3/16 in	1	K9806Z-3.3/16
3 1/4 in	1	K9806Z-3.1/4
3 5/16 in	1	K9806Z-3.5/16
3 3/8 in	1	K9806Z-3.3/8
3 7/16 in	1	K9806Z-3.7/16
3 1/2 in	1	K9806Z-3.1/2
3 9/16 in	1	K9806Z-3.9/16
3 5/8 in	1	K9806Z-3.5/8
3 11/16 in	1	K9806Z-3.11/16
3 3/4 in	1	K9806Z-3.3/4
3 13/16 in	1	K9806Z-3.13/16
3 7/8 in	1	K9806Z-3.7/8
3 15/16 in	1	K9806Z-3.15/16
4 in	1	K9806Z-4
4 1/16 in	1	K9806Z-4.1/16
4 1/8 in	1	K9806Z-4.1/8
4 1/4 in	1	K9806Z-4.1/4
4 5/16 in	1	K9806Z-4.5/16
4 3/8 in	1	K9806Z-4.3/8
4 7/16 in	1	K9806Z-4.7/16
4 1/2 in	1	K9806Z-4.1/2
4 5/8 in	1	K9806Z-4.5/8
4 3/4 in	1	K9806Z-4.3/4

1-1/2" universalknut med fyrkantfäste, svartoxiderad yta



K9867S



1 1/2 1 1/2 1 K9867S

1-1/2" förlängare med fyrkantfäste, svartoxiderad yta



K9860H



255 mm	1	K9860H-1
380 mm	1	K9860H-2
510 mm	1	K9860H-3

1-1/2" mellanstycke med fyrkantfäste, svartoxiderad yta



K9598H



1 1 1/2 1 K9598H

Adapter, mellanstycke 2-1/2" till 1-1/2" med fyrkantsfäste och svartoxiderad yta



K9998H



2 1/2



1 1/2



1 K9998H

Adapter, mellanstycke 1-1/2" till 2-1/2" med fyrkantsfäste och svartoxiderad yta



K9899H



1 1/2



2 1/2



1 K9899H

Låsring för 1-1/2" krafthylsa



K560F-9



1 1/2"



95-120 mm



5 K560F-9





BAHCO



Skruvmejslar



ERGO™ SKRUVMEJSLAR MED GUMMIGREPP OCH FÄRG-ID

ERGO™ spårskruvmejsel, rak spets, med gummigrepp, 0,3–1,2 mm x 60–200 mm



ergo



BE-8002–BE-8252



Spetsbredd	Längd	Skruvbredd	Skruvlängd	Antal	Modell
2.0 mm	60 mm	17 mm	103 mm	5	BE-8002
2.5 mm	60 mm	17 mm	103 mm	5	BE-8010
2.5 mm	75 mm	17 mm	103 mm	5	BE-8210
3.0 mm	60 mm	17 mm	103 mm	5	BE-8020
3.0 mm	75 mm	17 mm	103 mm	5	BE-8020L
3.0 mm	100 mm	17 mm	103 mm	5	BE-8022
3.0 mm	125 mm	17 mm	103 mm	5	BE-8220
3.0 mm	200 mm	17 mm	103 mm	5	BE-8225
3.5 mm	75 mm	17 mm	103 mm	5	BE-8030
3.5 mm	125 mm	17 mm	103 mm	5	BE-8230
3.5 mm	200 mm	17 mm	103 mm	5	BE-8235
4.0 mm	100 mm	20 mm	122 mm	5	BE-8040
4.0 mm	175 mm	20 mm	122 mm	5	BE-8240
5.5 mm	125 mm	27 mm	122 mm	5	BE-8241
5.5 mm	150 mm	27 mm	122 mm	5	BE-8242
5.5 mm	200 mm	27 mm	122 mm	5	BE-8250L
6.0 mm	150 mm	36 mm	122 mm	5	BE-8251
6.5 mm	150 mm	36 mm	122 mm	5	BE-8252

ERGO™ spårskruvmejslar, rak spets, med gummigrepp, 5,5–10 mm x 100–200 mm



ergo



BE-8150–BE-8258



Spetsbredd	Längd	Skruvbredd	Skruvlängd	Antal	Modell
5.5 mm	100 mm	27 mm	122 mm	5	BE-8150
5.5 mm	150 mm	27 mm	122 mm	5	BE-8250
6.5 mm	125 mm	36 mm	122 mm	5	BE-8155
6.5 mm	150 mm	36 mm	122 mm	5	BE-8255
8 mm	150 mm	36 mm	122 mm	5	BE-8256
8 mm	175 mm	36 mm	122 mm	5	BE-8257
10 mm	200 mm	36 mm	161 mm	5	BE-8258

ERGO™ spårskruvmejsel med sexkantsskrage och gummigrepp, 5,5–14 mm x 247–361 mm



ergo



BE-8158–BE-8890



Spetsbredd	Längd	Skruvbredd	Skruvlängd	Antal	Modell
5.5 mm	125 mm	27 mm	122 mm	5	BE-8158
6.5 mm	150 mm	36 mm	122 mm	5	BE-8159
8 mm	125 mm	36 mm	122 mm	5	BE-8160
8 mm	175 mm	36 mm	122 mm	5	BE-8260
8 mm	175 mm	36 mm	161 mm	5	BE-8865
10 mm	175 mm	36 mm	161 mm	5	BE-8870
12 mm	200 mm	36 mm	161 mm	5	BE-8880
14 mm	200 mm	36 mm	161 mm	5	BE-8890

ERGO™ rak spårskruvmejsel med kort gummigrepp, 0,6–1,2 mm



ergo



BE-8330–BE-8360



Spetsbredd	Längd	Skruvbredd	Skruvlängd	Antal	Modell
3.5 mm	25 mm	36 mm	58 mm	5	BE-8330
4.0 mm	25 mm	36 mm	58 mm	5	BE-8340
5.0 mm	25 mm	36 mm	58 mm	5	BE-8350
5.0 mm	45 mm	36 mm	58 mm	5	BE-8450
6.5 mm	25 mm	36 mm	58 mm	5	BE-8355
6.0 mm	45 mm	36 mm	58 mm	5	BE-8455
8.0 mm	25 mm	36 mm	58 mm	5	BE-8360

ERGO™ skruvmejsel för Phillips®-skruv med gummigrepp, PH0–PH4 x 182–322 mm



ergo



BE-8600–BE-8624



Spetsbredd	Längd	Skruvbredd	Skruvlängd	Antal	Modell
PH 0	60 mm	17 mm	103 mm	5	BE-8600
PH 0	100 mm	17 mm	103 mm	5	BE-8605
PH 0	200 mm	17 mm	103 mm	5	BE-8608
PH 1	75 mm	27 mm	122 mm	5	BE-8610
PH 1	75 mm	20 mm	122 mm	5	BE-8611
PH 1	* 200 mm	27 mm	122 mm	5	BE-8610L

PH 2	100 mm	36 mm	122 mm	5	BE-8620	
PH 2	100 mm	27 mm	122 mm	5	BE-8621	
PH 2	150 mm	36 mm	122 mm	5	BE-8622	
PH 2	* 200 mm	36 mm	122 mm	5	BE-8620L	
PH 3	150 mm	36 mm	122 mm	5	BE-8623	
PH 4	200 mm	36 mm	161 mm	5	BE-8624	

ERGO™ Phillips skruvmejsel, med sexkantsgrepp, dubbelt handtag med gummigrepp, PH1-PH4 x 100–200 mm



ergo®



BE-8628–BE-8640



PH 1	100 mm	27 mm	122 mm	5	BE-8628	
PH 2	125 mm	36 mm	122 mm	5	BE-8629	
PH 3	150 mm	36 mm	122 mm	5	BE-8630	
PH 4	200 mm	36 mm	161 mm	5	BE-8640	

ERGO™ skruvmejsel för Phillips®-skruv av kort modell, handtag med gummigrepp, PH1, PH2



ergo®



BE-8601/BE-8602



PH 1	25 mm	36 mm	58 mm	5	BE-8601	
PH 2	25 mm	36 mm	58 mm	5	BE-8602	

ERGO™ skruvmejslar för Pozidriv®-skruv med gummigrepp, PZ0–PZ4 x 60–200 mm



ergo®



BE-8800–BE-8824



PZ 0	60 mm	17 mm	103 mm	5	BE-8800	
PZ 1	75 mm	27 mm	122 mm	5	BE-8810	

PZ 1	75 mm	20 mm	122 mm	5	BE-8811	
PZ 1	200 mm	27 mm	122 mm	5	BE-8810L	
PZ 2	100 mm	36 mm	122 mm	5	BE-8820	
PZ 2	100 mm	27 mm	122 mm	5	BE-8821	
PZ 2	200 mm	36 mm	122 mm	5	BE-8820L	
PZ 3	150 mm	36 mm	122 mm	5	BE-8823	
PZ 4	200 mm	36 mm	161 mm	5	BE-8824	

ERGO™ Pozidriv skruvmejsel med sexkants nyckelgrepp, dubbelt handtag med gummigrepp, PZ1-PZ4 x 100–200 mm



ergo®



BE-8828–BE-8840



PZ 1	100 mm	27 mm	122 mm	5	BE-8828	
PZ 2	125 mm	36 mm	122 mm	5	BE-8829	
PZ 3	150 mm	36 mm	122 mm	5	BE-8830	
PZ 4	200 mm	36 mm	161 mm	5	BE-8840	

ERGO™ skruvmejslar för Pozidriv®-skruv, kort modell med gummigrepp, PZ1-PZ2 x 25 mm



ergo®



BE-8801/BE-8802



PZ 1	25 mm	36 mm	58 mm	5	BE-8801	
PZ 2	25 mm	36 mm	58 mm	5	BE-8802	



ERGO™ skruvmejsel för Torx®-skruv med gummigrepp, T4–T45



ergo



BE-8904–BE-8945



T 4	75 mm	17 mm	103 mm	5	BE-8904	
T 5	75 mm	17 mm	103 mm	5	BE-8905	
T 6	75 mm	17 mm	103 mm	5	BE-8906	
T 7	75 mm	17 mm	103 mm	5	BE-8907	
T 8	75 mm	17 mm	103 mm	5	BE-8908	
T 9	75 mm	17 mm	103 mm	5	BE-8909	
T 10	75 mm	20 mm	122 mm	5	BE-8910	
T 15	100 mm	27 mm	122 mm	5	BE-8915	
T 20	100 mm	27 mm	122 mm	5	BE-8920	
T 25	125 mm	27 mm	122 mm	5	BE-8925	
T 27	125 mm	27 mm	122 mm	5	BE-8927	
T 30	150 mm	36 mm	122 mm	5	BE-8930	
T 40	150 mm	36 mm	161 mm	5	BE-8940	
T 45	150 mm	36 mm	161 mm	5	BE-8945	

ERGO™ skruvmejsel för Torx®-skruv och Torx®-skruv med centrumspets, gummigrepp med dubbelt handtag, TR7–TR40



ergo



BE-7907–BE-7940



TR 7	75 mm	17 mm	103 mm	5	BE-7907	
TR 8	75 mm	17 mm	103 mm	5	BE-7908	
TR 9	75 mm	17 mm	103 mm	5	BE-7909	
TR 10	75 mm	20 mm	122 mm	5	BE-7910	
TR 15	100 mm	27 mm	122 mm	5	BE-7915	
TR 20	100 mm	27 mm	122 mm	5	BE-7920	
TR 25	125 mm	27 mm	122 mm	5	BE-7925	
TR 27	125 mm	27 mm	122 mm	5	BE-7927	
TR 30	150 mm	36 mm	122 mm	5	BE-7930	
TR 40	150 mm	36 mm	161 mm	5	BE-7940	

ERGO™ Torx®-skruvmejsel med gummigrepp, T15–T40 x 100–150 mm



ergo



BE-7515–BE-7540



T 15	100 mm	27 mm	122 mm	5	BE-7515	
T 20	100 mm	27 mm	122 mm	5	BE-7520	
T 25	125 mm	27 mm	122 mm	5	BE-7525	
T 27	125 mm	27 mm	122 mm	5	BE-7527	
T 30	150 mm	36 mm	122 mm	5	BE-7530	
T 40	150 mm	36 mm	122 mm	5	BE-7540	

ERGO™ Torx® Plus-skrvmejsel med gummigrepp, T15–T40



ergo



BE-7715–BE-7740



T 15	100 mm	27 mm	122 mm	5	BE-7715	
T 20	100 mm	27 mm	122 mm	5	BE-7720	
T 25	125 mm	27 mm	122 mm	5	BE-7725	
T 27	125 mm	27 mm	122 mm	5	BE-7727	
T 30	150 mm	36 mm	122 mm	5	BE-7730	
T 40	150 mm	36 mm	122 mm	5	BE-7740	

ERGO™ insexskruvmejsel med gummigrepp, 2–3 mm



ergo



BE-6902–BE-6903



2 mm	75 mm	17 mm	103 mm	5	BE-6902	
2.5 mm	75 mm	17 mm	103 mm	5	BE-6925	
3 mm	75 mm	20 mm	122 mm	5	BE-6903	

ERGO™ insexskruvmejsel med dubbelt handtag med gummigrepp, 1,5-10 mm x 60-150 mm



ergo



BE-8715-BE-8710



Skruvstorlek	Skruv	Skruv	Skruv	Skruv	Skruv
1.5 mm	60 mm	17 mm	103 mm	5	BE-8715
2 mm	100 mm	17 mm	103 mm	5	BE-8702
2.5 mm	100 mm	17 mm	103 mm	5	BE-8725
3 mm	100 mm	20 mm	122 mm	5	BE-8703
4 mm	100 mm	27 mm	122 mm	5	BE-8704
5 mm	100 mm	36 mm	122 mm	5	BE-8705
6 mm	125 mm	36 mm	122 mm	5	BE-8706
8 mm	150 mm	36 mm	122 mm	5	BE-8708
10 mm	150 mm	36 mm	161 mm	5	BE-8710

ERGO™ insexskruvmejsel med dubbla handtag med gummigrepp, 7/64-3/8"



ergo



BE-8700-7/64-BE-8700-5/16



Skruvstorlek	Skruv	Skruv	Skruv	Skruv	Skruv
7/64 in	100 mm	20 mm	122 mm	5	BE-8700-7/64
5/32 in	100 mm	27 mm	122 mm	5	BE-8700-5/32
3/16 in	100 mm	27 mm	122 mm	5	BE-8700-3/16
7/32 in	100 mm	36 mm	122 mm	5	BE-8700-7/32
1/4 in	125 mm	36 mm	122 mm	5	BE-8700-1/4
5/16 in	150 mm	36 mm	122 mm	5	BE-8700-5/16
3/8 in	150 mm	36 mm	161 mm	5	BE-8700-3/8

ERGO™ skruvmejsel för Robertson-skruv (fyrkantsskruv), med gummigrepp #1-#3



ergo



BE-9001-BE-9003



Skruvstorlek	Skruv	Skruv	Skruv	Skruv	Skruv
# 1	80 mm	27 mm	122 mm	5	BE-9001
# 2	80 mm	27 mm	122 mm	5	BE-9002
# 3	100 mm	27 mm	122 mm	5	BE-9003

ERGO™ TRI-WING® säkerhetsskruvmejslar med gummigrepp #0-#5



ergo



BE-9100-BE-9105



Skruvstorlek	Skruv	Skruv	Skruv	Skruv	Skruv
0	80 mm	20 mm	122 mm	5	BE-9100
1	80 mm	20 mm	122 mm	5	BE-9101
2	80 mm	27 mm	122 mm	5	BE-9102
3	80 mm	27 mm	122 mm	5	BE-9103
4	100 mm	27 mm	122 mm	5	BE-9104
5	100 mm	27 mm	122 mm	5	BE-9105

ERGO™ TORQ-SET® säkerhetsskruvmejslar med gummigrepp, nr 1-10



ergo



BE-8080



Skruvstorlek	Skruv	Skruv	Skruv	Skruv	Skruv
1	75 mm	27 mm	122 mm	5	BE-8080-1
2	75 mm	27 mm	122 mm	5	BE-8080-2
3	75 mm	27 mm	122 mm	5	BE-8080-3
4	75 mm	27 mm	122 mm	5	BE-8080-4
5	75 mm	27 mm	122 mm	5	BE-8080-5
6	75 mm	27 mm	122 mm	5	BE-8080-6
8	100 mm	27 mm	122 mm	5	BE-8080-8
10	100 mm	27 mm	122 mm	5	BE-8080-10

För Torq-set®-skruv

ERGO™ syl med rund spets och gummigrepp



ergo



BE-8985

Skruvstorlek	Skruv	Skruv	Skruv	Skruv	Skruv
6 mm	100 mm	27 mm	122 mm	5	BE-8985



ERGO™ syl med rund spets och gummigrepp, kort modell



ergo



BE-8986

4 mm	36 mm	50 mm	58 mm		5	BE-8986

ERGO™ pryl med fyrkantig spets och gummigrepp



ergo



BE-8980

6 mm	100 mm	27 mm	122 mm		5	BE-8980

ERGO™ sexkants hylsskruvmejsel med gummigrepp, 4-7 mm



ergo



BE-6400M

4 mm	100 mm	20 mm	122 mm		5	BE-6400M-4
5 mm	100 mm	20 mm	122 mm		5	BE-6400M-5
5.5 mm	100 mm	20 mm	122 mm		5	BE-6400M-5.5
7 mm	100 mm	20 mm	122 mm		5	BE-6400M-7

ERGO™ sexkants hylsskruvmejsel med lång hylsa och gummigrepp 3-14 mm



ergo



BE-78

3 mm	125 mm	20 mm	122 mm		5	BE-7803
3.5 mm	125 mm	20 mm	122 mm		5	BE-7835
4 mm	125 mm	20 mm	122 mm		5	BE-7804
4.5 mm	125 mm	20 mm	122 mm		5	BE-7845
5 mm	125 mm	20 mm	122 mm		5	BE-7805
5.5 mm	125 mm	20 mm	122 mm		5	BE-7855
6 mm	125 mm	20 mm	122 mm		5	BE-7806
7 mm	125 mm	27 mm	122 mm		5	BE-7807
8 mm	125 mm	27 mm	122 mm		5	BE-7808
9 mm	125 mm	36 mm	122 mm		5	BE-7809
10 mm	125 mm	36 mm	122 mm		5	BE-7810
11 mm	125 mm	36 mm	122 mm		5	BE-7811
12 mm	125 mm	36 mm	122 mm		5	BE-7812
13 mm	125 mm	36 mm	161 mm		5	BE-7813
14 mm	125 mm	36 mm	161 mm		5	BE-7814

ERGO™ sexkants hylsskruvmejsel med flexibelt handtag med gummigrepp, 6-8 mm



ergo



BE-76

6 mm	150 mm	27 mm	122 mm		5	BE-7606
7 mm	150 mm	27 mm	122 mm		5	BE-7607
8 mm	150 mm	27 mm	122 mm		5	BE-7608

Sats med ERGO™ skruvmejslar med gummigrepp, för Torx®-skruv - 5 st



ergo



BE-9885



5

1 BE-9885

BE-8910, BE-8930, BE-8915, BE-8920, BE-8925



Sats med ERGO™ skruvmejslar för spår-, Phillips®, Pozidriv- och Torx®-skruv med gummigrepp - 6 st.



ergo



BE-9881



6

1 BE-9881

BE-8020, BE-8040



BE-8150, BE-8155



BE-8620, BE-8610



Sats med ERGO™ skruvmejslar för spår- och Pozidriv-skruv med gummigrepp - 6 st.



ergo



BE-9882



6

1 BE-9882

BE-8020, BE-8040



BE-8155, BE-8150



BE-8810, BE-8820



Sats med ERGO™ skruvmejslar för spår-, Phillips®, Pozidriv-skruv, med gummigrepp, 4 mm x 100 mm, 5,5 mm x 125 mm - 6 st.



ergo



BE-9884



6

1 BE-9884

BE-8611, BE-8621



BE-8040, BE-8241



BE-8811, BE-8821



Sats med ERGO™ skruvmejslar med gummigrepp, för spår-, Phillips®- och Pozidriv-skruv - 6 st.



ergo



BE-9886



6

1 BE-9886

BE-8030



BE-8150



BE-8621, BE-8611



BE-8821, BE-8811



Sats med ERGO™ skruvmejslar för spår-, Phillips®, Pozidriv- och Torx®-skruv med gummigrepp – 6 st.



ergo



BE-9871

6 1 BE-9871

BE-8220S		
BE-8920, BE-8925		
BE-8820		
BE-8611, BE-8620		

Sats med ERGO™ skruvmejslar med gummigrepp, för spår-, Phillips®, Pozidriv- och Torx®-skruv. 8 st.



ergo



BE-9872

8 1 BE-9872

45 x 170 x 340 mm 595 g

BE-8925, BE-8920, BE-8915		
BE-8030		
BE-8821, BE-8811		
BE-8621, BE-8611		

Sats med ERGO™ skruvmejslar för spår-, Phillips®, Pozidriv- och Torx®-skruv med gummigrepp – 13 st.



ergo



BE-9875

13 1 BE-9875

BE-8040		
BE-8150, BE-8155		
BE-8621		
BE-8811, BE-8821		
BE-8910, BE-8915, BE-8920, BE-8925		
BE-8010S, BE-8230S		
BE-8811S		

Sats med ERGO™ skruvmejslar med gummigrepp, för spår-, Phillips®, Pozidriv- och Torx®-skruv – 13 st.



ergo



BE-9879

13 1 BE-9879

BE-8010, BE-8040		
BE-8150		
BE-8611, BE-8621		
BE-8811, BE-8821		
BE-8910, BE-8915, BE-8920, BE-8925		
BE-8220SL		
BE-8620SL		

Sats med ERGO™ skruvmejslar för spår-, Phillips®, Pozidriv- och Torx®-skruv med gummigrepp – 15 st.



ergo



BE-9877



15

1 BE-9877

BE-8030



BE-8150



BE-8611, BE-8621



BE-8811, BE-8821



BE-8910, BE-8915, BE-8920, BE-8925



BE-8220S, BE-8040S, BE-8050S



BE-8611S, BE-8621S



ERGO™ magnetisk bitsskruvmejsel med gummigrepp för 1/4" sexkantsbits



ergo



BE-8577



1/4 in

118 mm

36 mm

122 mm

5 BE-8577

ERGO™ skruvmejselhandtag med gummigrepp för 1/4" sexkantiga klingor



ergo



BE-8575



1/4 in

122 mm

1 BE-8575

ERGO™ 1/4" sexkantig klinga för 0,5-1,2 mm spårskruv



8020-2P-8252-2P



3.0 mm

0.5 mm

1 8020-2P

3.5 mm

0.6 mm

1 8030-2P

4.0 mm

0.8 mm

1 8040-2P

5.5 mm

1.0 mm

1 8242-2P

6.5 mm

1.2 mm

1 8252-2P

ERGO™ 1/4" sexkantiga klingor för PH0-PH3 Phillips-skruv



8600-2P-8630-2P



0

1 8600-2P

1

1 8610-2P

2

1 8620-2P

3

1 8630-2P

ERGO™ 1/4" sexkantiga klingor för PZ0-PZ3 Pozidriv-skruv



8800-2P-8830-2P



0

1 8800-2P

1

1 8810-2P

2

1 8820-2P

3

1 8830-2P



ERGO™ 1/4" sexkantiga klingor för T10-T40 Torx®-skruv



8910-2P-8940-2P



10	1	8910-2P
15	1	8915-2P
20	1	8920-2P
25	1	8925-2P
27	1	8927-2P
30	1	8930-2P
40	1	8940-2P

ERGO™ 1/4" sexkantiga klingor för PH1-PH2 Phillips-skruv



8610L-2P-8620L-2P



1	1	8610L-2P
2	1	8620L-2P

ERGO™ 1/4" sexkantiga klingor för 3-6 mm-skruv med kula



8703-2P-8706-2P



3 mm	1	8703-2P
4 mm	1	8704-2P
5 mm	1	8705-2P
6 mm	1	8706-2P

ERGO™ 1/4" sexkantiga klingor för PZ1-PZ2 Pozidriv-skruv



8810L-2P-8820L-2P



1	1	8810L-2P
2	1	8820L-2P

ERGO™ 1/4" sexkantig klinga för 0,8-1,2 mm spårskruv



8040L-2P-8252L-2P



0.8 mm	4.0 mm	1 8040L-2P
1.0 mm	5.5 mm	1 8242L-2P
1.2 mm	6.5 mm	1 8252L-2P

ERGO™ 1/4" sexkantiga klingor för T15-T30 Torx®-skruv



8915L-2P-8930L-2P



T15	1	8915L-2P
T20	1	8920L-2P
T25	1	8925L-2P
T27	1	8927L-2P
T30	1	8930L-2P

ERGO™ 1/4" sexkantiga klingor för PH2-PH3 Phillips-skruv



8620XL-1P-8252XL-1P



2	1	8620XL-1P
3	1	8630XL-1P

ERGO™ 1/4" sexkantiga klingor för PZ2-PZ3 Pozidriv-skruv



8820XL-1P-8830XL-1P



2	1	8820XL-1P
3	1	8830XL-1P

ERGO™ 1/4" sexkantig klinga för 1,2-2 mm spårskruv



8252XL-1P-8256XL-1P



1.2 mm	6.5 mm	1	8252XL-1P
--------	--------	---	-----------

ERGO™ skruvmejsel med gummigrepp och sats med utbytbara skruvmejselklingor – 7 delar



ergo



BE-8571



7	85 x 85 x 210 mm	1	BE-8571
---	------------------	---	---------

BE-8575

8242-2P, 8252-2P

8610-2P, 8620-2P

8810-2P, 8820-2P



ERGO™ skruvmejsel med gummigrepp och sats med utbytbara skruvmejselklingor – 9 delar



ergo



BE-8572



9	85 x 80 x 210 mm	1	BE-8572
---	------------------	---	---------

BE-8575

8242-2P, 8252-2P

8610-2P, 8620-2P

8810-2P, 8820-2P

8910-2P, 8915-2P

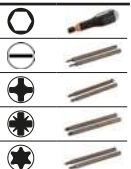

ERGO™ skruvmejsel med gummigrepp och sats med utbytbara Torx®-I skruvmejselklingor – 8 delar



ergo



BE-8573

8	85 x 85 x 210 mm	1	BE-8573

BE-8575		
8910-2P, 8915-2P, 8920-2P, 8925-2P, 8927-2P, 8930-2P, 8940-2P		

ERGO™ skruvmejsel med gummigrepp och sats med utbytbara skruvmejselklingor – 8 delar



ergo



BE-8574

8	85 x 85 x 210 mm	1	BE-8574

BE-8575		
8610-2P, 8620-2P		
8040-2P		
8820-2P		
8920-2P, 8925-2P, 8930-2P		

ERGO™ skruvmejsel med gummigrepp och sats med utbytbara skruvmejselklingor – 22 delar



ergo



BE-8576

23		1 BE-8576

BE-8575		
8030-2P, 8040-2P, 8242-2P, 8252-2P		
8810-2P, 8820-2P, 8830-2P		
8610-2P, 8620-2P, 8630-2P		
8910-2P, 8915-2P, 8925-2P, 8930-2P, 8940-2P		
59S/H2, 59S/H3, 59S/H5, 59S/H4, 59S/H6, 59S/H8		

ERGO™ SKRUVMEJSLAR MED STÖTTÄLIGT GREPP

ERGO™ skruvmejslar med genomgående klinga och stöttäligt grepp 0,6–1,2 mm



ergo



BE-8135TB–BE-8262TB

3.5 mm	75 mm	27 mm	122 mm	10	BE-8135TB
4.5 mm	100 mm	27 mm	122 mm	10	BE-8145TB
5.5 mm	100 mm	27 mm	122 mm	10	BE-8150TB
6.5 mm	125 mm	36 mm	122 mm	5	BE-8155TB
8 mm	150 mm	36 mm	122 mm	10	BE-8256TB
10 mm	175 mm	36 mm	122 mm	10	BE-8258TB
12 mm	200 mm	36 mm	122 mm	10	BE-8262TB
3.5 mm	75 mm	27 mm	122 mm	1	SBE-8135TB
4.5 mm	100 mm	27 mm	122 mm	1	SBE-8145TB
5.5 mm	100 mm	27 mm	122 mm	1	SBE-8150TB
6.5 mm	125 mm	36 mm	122 mm	1	SBE-8155TB

ERGO™ skruvmejslar för Phillips-skruv med genomgående klinga och stöttåligt grepp PH1-PH4



ergo



BE-8610TB–BE-8624TB



PH 1	100 mm	27 mm	122 mm	10	BE-8610TB
PH 2	125 mm	36 mm	122 mm	10	BE-8620TB
PH 3	150 mm	36 mm	122 mm	10	BE-8623TB
PH 4	175 mm	36 mm	122 mm	10	BE-8624TB
PH 1	100 mm	27 mm	122 mm	1	SBE-8610TB
PH 2	125 mm	36 mm	122 mm	1	SBE-8620TB

ERGO™ skruvmejslar för Pozidriv®-skruv med genomgående klinga och slagåligt grepp PZ1-PZ4



ergo



BE-8810TB–BE-8824TB



PZ 1	100 mm	27 mm	122 mm	10	BE-8810TB
PZ 2	125 mm	36 mm	122 mm	10	BE-8820TB
PZ 3	150 mm	36 mm	122 mm	10	BE-8823TB
PZ 4	175 mm	36 mm	122 mm	10	BE-8824TB
PZ 1	100 mm	27 mm	122 mm	1	SBE-8810TB
PZ 2	125 mm	36 mm	122 mm	1	SBE-8820TB

ERGO™ Torx®-skruvmejslar med genomgående klinga och slagåligt grepp T10-T40



ergo



BE-8910TB–BE-8940TB



T 10	75 mm	27 mm	122 mm	5	BE-8910TB
T 15	100 mm	27 mm	122 mm	5	BE-8915TB
T 20	100 mm	27 mm	122 mm	5	BE-8920TB

T 25	100 mm	27 mm	122 mm	5	BE-8925TB
T 27	125 mm	27 mm	122 mm	5	BE-8927TB
T 30	150 mm	36 mm	122 mm	5	BE-8930TB
T 40	150 mm	36 mm	122 mm	5	BE-8940TB
T 15	100 mm	27 mm	122 mm	1	SBE-8915TB
T 20	100 mm	27 mm	122 mm	1	SBE-8920TB
T 25	100 mm	27 mm	122 mm	1	SBE-8925TB
T 30	150 mm	36 mm	122 mm	1	SBE-8930TB
T 40	150 mm	36 mm	122 mm	1	SBE-8940TB

ERGO™ sats med skruvmejslar för spår- och Phillips®-skruv med genomgående klinga och stöttåligt grepp



ergo



BE-9881TB



6



1 BE-9881TB

BE-8135TB, BE-8145TB, BE-8150TB, BE-8155TB



BE-8610TB, BE-8620TB



ERGO™ sats med skruvmejslar för spår-, Pozidriv- och insexskruv, med genomgående klinga och slagåligt grepp



ergo



BE-9882TB



6



1 BE-9882TB

BE-8135TB, BE-8145TB, BE-8150TB, BE-8155TB



BE-8610TB, BE-8620TB

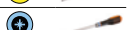

Sats med skruvmejslar ERGO™, genomgående klinga, för Torx®skruvar med stöttåligt grepp – 5 st



ergo



BE-9885TB



5

1 BE-9885TB

BE-8915TB, BE-8920TB, BE-8925TB, BE-8930TB, BE-8940TB



BAHCOFIT-SKRUVMEJSLAR MED RAFFLAT GUMMIGREPP

BahcoFit rak spårskruvmejsel med gummigrepp, 0,8–2 mm



B190



4 mm	75 mm	24,5 mm	95 mm	10	B190.040.075
4 mm	100 mm	24,5 mm	95 mm	10	B190.040.100
5.5 mm	100 mm	30 mm	105 mm	10	B190.055.100
5.5 mm	125 mm	30 mm	105 mm	10	B190.055.125
6.5 mm	125 mm	34 mm	117 mm	10	B190.065.125
6.5 mm	150 mm	34 mm	117 mm	10	B190.065.150
8 mm	150 mm	34 mm	117 mm	10	B190.080.150
8 mm	175 mm	34 mm	117 mm	10	B190.080.175
10 mm	200 mm	34 mm	117 mm	10	B190.100.200
12 mm	250 mm	34 mm	117 mm	10	B190.120.250
14 mm	250 mm	34 mm	117 mm	10	B190.140.250
4 mm	75 mm	24,5 mm	95 mm	1	SB190.040.075
4 mm	100 mm	24,5 mm	95 mm	1	SB190.040.100
5.5 mm	100 mm	30 mm	105 mm	1	SB190.055.100
5.5 mm	125 mm	30 mm	105 mm	1	SB190.055.125
6.5 mm	125 mm	34 mm	117 mm	1	SB190.065.125
6.5 mm	150 mm	34 mm	117 mm	1	SB190.065.150
8 mm	150 mm	34 mm	117 mm	1	SB190.080.150
8 mm	175 mm	34 mm	117 mm	1	SB190.080.175
10 mm	200 mm	34 mm	117 mm	1	SB190.100.200
12 mm	250 mm	34 mm	117 mm	1	SB190.120.250
14 mm	250 mm	34 mm	117 mm	1	SB190.140.250



BahcoFit rak spårskruvmejsel med gummigrepp, 0,4–1,2 mm



B191



2.5 mm	75 mm	24,5 mm	95 mm	10	B191.025.075
3 mm	75 mm	24,5 mm	95 mm	10	B191.030.075
3 mm	100 mm	24,5 mm	95 mm	10	B191.030.100
3 mm	200 mm	24,5 mm	95 mm	10	B191.030.200
3.5 mm	100 mm	24,5 mm	95 mm	10	B191.035.100
4 mm	100 mm	24,5 mm	95 mm	10	B191.040.100
4 mm	125 mm	24,5 mm	95 mm	10	B191.040.125
4 mm	250 mm	24,5 mm	95 mm	10	B191.040.250
5.5 mm	125 mm	30 mm	105 mm	10	B191.055.125
5.5 mm	150 mm	30 mm	105 mm	10	B191.055.150
5.5 mm	300 mm	30 mm	105 mm	10	B191.055.300
6.5 mm	150 mm	34 mm	117 mm	10	B191.065.150
6.5 mm	300 mm	34 mm	117 mm	10	B191.065.300
2.5 mm	75 mm	24,5 mm	95 mm	1	SB191.025.075
3 mm	75 mm	24,5 mm	95 mm	1	SB191.030.075
3 mm	100 mm	24,5 mm	95 mm	1	SB191.030.100
3 mm	200 mm	24,5 mm	95 mm	1	SB191.030.200
3.5 mm	100 mm	24,5 mm	95 mm	1	SB191.035.100
4 mm	100 mm	24,5 mm	95 mm	1	SB191.040.100
4 mm	125 mm	24,5 mm	95 mm	1	SB191.040.125
4 mm	250 mm	24,5 mm	95 mm	1	SB191.040.250
5.5 mm	125 mm	30 mm	105 mm	1	SB191.055.125
5.5 mm	150 mm	30 mm	105 mm	1	SB191.055.150
5.5 mm	300 mm	30 mm	105 mm	1	SB191.055.300
6.5 mm	150 mm	34 mm	117 mm	1	SB191.065.150
6.5 mm	300 mm	34 mm	117 mm	1	SB191.065.300



BahcoFit rak spårskruvmejsel med kort gummigrepp, 0,8–1,2 mm



B195



4 mm	25 mm	33 mm	60 mm	10	B195.040.025
5.0 mm	25 mm	33 mm	60 mm	10	B195.050.025
6 mm	25 mm	33 mm	60 mm	10	B195.060.025
4 mm	25 mm	33 mm	60 mm	1	SB195.040.025
5 mm	25 mm	33 mm	60 mm	1	SB195.050.025
6 mm	25 mm	33 mm	60 mm	1	SB195.060.025



BAHCO

BahcoFit skruvmejsel för Phillips®-skruv med gummigrepp, PH0–PH4



B192



PH0	75 mm	24,5 mm	95 mm	10	B192.000.075
PH0	200 mm	24,5 mm	95 mm	10	B192.000.200
PH1	100 mm	30 mm	105 mm	10	B192.001.100
PH1	250 mm	30 mm	105 mm	10	B192.001.250
PH2	125 mm	34 mm	117 mm	10	B192.002.125
PH2	150 mm	34 mm	117 mm	10	B192.002.150
PH2	300 mm	34 mm	117 mm	10	B192.002.300
PH3	150 mm	34 mm	117 mm	10	B192.003.150
PH4	200 mm	34 mm	117 mm	10	B192.004.200
PH0	75 mm	24,5 mm	95 mm	1	SB192.000.075
PH0	200 mm	24,5 mm	95 mm	1	SB192.000.200
PH1	100 mm	30 mm	105 mm	1	SB192.001.100
PH1	250 mm	30 mm	105 mm	1	SB192.001.250
PH2	125 mm	34 mm	117 mm	1	SB192.002.125
PH2	300 mm	34 mm	117 mm	1	SB192.002.300
PH3	150 mm	34 mm	117 mm	1	SB192.003.150
PH4	200 mm	34 mm	117 mm	1	SB192.004.200

BahcoFit skruvmejsel i kort modell för Phillips®-skruv, med gummigrepp, PH1–PH2



B195PH



PH1	25 mm	33 mm	60 mm	10	B195.001.025
PH2	25 mm	33 mm	60 mm	10	B195.002.025
PH1	25 mm	33 mm	60 mm	1	SB195.001.025
PH2	25 mm	33 mm	60 mm	1	SB195.002.025

BahcoFit skruvmejslar för Pozidriv®-skruv med gummigrepp, PZ0–PZ4



B193



PZ0	75 mm	24,5 mm	95 mm	10	B193.000.075
PZ1	100 mm	30 mm	105 mm	10	B193.001.100
PZ2	125 mm	34 mm	117 mm	10	B193.002.125
PZ3	150 mm	34 mm	117 mm	10	B193.003.150
PZ4	200 mm	34 mm	117 mm	10	B193.004.200
PZ0	75 mm	24,5 mm	95 mm	1	SB193.000.075
PZ1	100 mm	30 mm	105 mm	1	SB193.001.100
PZ2	125 mm	34 mm	117 mm	1	SB193.002.125
PZ3	150 mm	34 mm	117 mm	1	SB193.003.150
PZ4	200 mm	34 mm	117 mm	1	SB193.004.200

BahcoFit skruvmejsel i kort modell för Pozidriv®-skruv, med gummigrepp, PZ1–PZ2



B195PZ



PZ1	25 mm	33 mm	60 mm	10	B195.901.025
PZ2	25 mm	33 mm	60 mm	10	B195.902.025
PZ1	25 mm	33 mm	60 mm	1	SB195.901.025
PZ2	25 mm	33 mm	60 mm	1	SB195.902.025



BahcoFit skruvmejslar för Torx®-skruv med gummigrepp, T4-T45



B194

T4	75 mm	24,5 mm	95 mm	10	B194.004.075	
T5	75 mm	24,5 mm	95 mm	10	B194.005.075	
T6	75 mm	24,5 mm	95 mm	10	B194.006.075	
T7	75 mm	24,5 mm	95 mm	10	B194.007.075	
T8	75 mm	24,5 mm	95 mm	10	B194.008.075	
T9	75 mm	24,5 mm	95 mm	10	B194.009.075	
T10	75 mm	24,5 mm	95 mm	10	B194.010.075	
T15	100 mm	24,5 mm	95 mm	10	B194.015.100	
T20	100 mm	24,5 mm	95 mm	10	B194.020.100	
T25	125 mm	30 mm	105 mm	10	B194.025.125	
T27	125 mm	30 mm	105 mm	10	B194.027.125	
T30	150 mm	34 mm	117 mm	10	B194.030.150	
T40	150 mm	34 mm	117 mm	10	B194.040.150	
T45	150 mm	34 mm	117 mm	5	B194.045.150	
T4	75 mm	24,5 mm	95 mm	1	SB194.004.075	
T5	75 mm	24,5 mm	95 mm	1	SB194.005.075	
T6	75 mm	24,5 mm	95 mm	1	SB194.006.075	
T7	75 mm	24,5 mm	95 mm	1	SB194.007.075	
T8	75 mm	24,5 mm	95 mm	1	SB194.008.075	
T9	75 mm	24,5 mm	95 mm	1	SB194.009.075	
T10	75 mm	24,5 mm	95 mm	1	SB194.010.075	
T15	100 mm	24,5 mm	95 mm	1	SB194.015.100	
T20	100 mm	24,5 mm	95 mm	1	SB194.020.100	
T25	125 mm	30 mm	105 mm	1	SB194.025.125	
T27	125 mm	30 mm	105 mm	1	SB194.027.125	
T30	150 mm	34 mm	117 mm	1	SB194.030.150	
T40	150 mm	34 mm	117 mm	1	SB194.040.150	
T45	150 mm	34 mm	117 mm	1	SB194.045.150	

BahcoFit Torx®-skruvmejsel med centrumpets och gummigrepp, TR7-TR40



B141

TR7	75 mm	24,5 mm	5	B141.007.075		
TR8	75 mm	24,5 mm	5	B141.008.075		
TR9	75 mm	24,5 mm	5	B141.009.075		
TR10	75 mm	24,5 mm	5	B141.010.075		
TR15	100 mm	24,5 mm	5	B141.015.100		
TR20	100 mm	24,5 mm	5	B141.020.100		
TR25	125 mm	30 mm	5	B141.025.125		
TR27	125 mm	30 mm	5	B141.027.125		
TR30	150 mm	34 mm	5	B141.030.150		
TR40	150 mm	34 mm	5	B141.040.150		

TR7	75 mm	24,5 mm	1	SB141.007.075		
TR8	75 mm	24,5 mm	1	SB141.008.075		
TR9	75 mm	24,5 mm	1	SB141.009.075		
TR10	75 mm	24,5 mm	1	SB141.010.075		
TR15	100 mm	24,5 mm	1	SB141.015.100		
TR20	100 mm	24,5 mm	1	SB141.020.100		
TR25	125 mm	30 mm	1	SB141.025.125		
TR27	125 mm	30 mm	1	SB141.027.125		
TR30	150 mm	34 mm	1	SB141.030.150		
TR40	150 mm	34 mm	1	SB141.040.150		

BahcoFit skruvmejsel med gummigrepp och sexkantkula för insexskruv, 2 – 8 mm



B143

2	100 mm	24,5 mm	95 mm	5	B143.020.100	
2,5	100 mm	24,5 mm	95 mm	10	B143.025.100	
3	100 mm	24,5 mm	95 mm	10	B143.030.100	
4	100 mm	24,5 mm	95 mm	10	B143.040.100	
5	100 mm	30 mm	105 mm	10	B143.050.100	
6	125 mm	34 mm	117 mm	10	B143.060.125	
8	150 mm	34 mm	117 mm	5	B143.080.150	
2	100 mm	24,5 mm	95 mm	1	SB143.020.100	
2,5	100 mm	24,5 mm	95 mm	1	SB143.025.100	
3	100 mm	24,5 mm	95 mm	1	SB143.030.100	
4	100 mm	24,5 mm	95 mm	1	SB143.040.100	
5	100 mm	30 mm	105 mm	1	SB143.050.100	
6	125 mm	34 mm	117 mm	1	SB143.060.125	
8	150 mm	34 mm	117 mm	1	SB143.080.150	

BahcoFit skruvmejslar för Robertson-skruv/fyrkantsskruv, med gummigrepp #1-#3



B144

#1	100 mm	24,5 mm	95 mm	5	B144.001.100	
#2	125 mm	30 mm	105 mm	5	B144.002.125	
#3	150 mm	34 mm	117 mm	5	B144.003.150	
#1	100 mm	24,5 mm	95 mm	1	SB144.001.100	
#2	125 mm	30 mm	105 mm	1	SB144.002.125	
#3	150 mm	34 mm	117 mm	1	SB144.003.150	

BahcoFit syl med gummigrepp upptagning av hål, 6 mm x 100 mm



B145

Ø	l	h	l	l	l
6 mm	100 mm	30 mm	105 mm	5	B145.006.100
6 mm	100 mm	30 mm	105 mm	1	SB145.006.100

BahcoFit pryl med gummigrepp för förstoring, upptagning av hål, 6 mm



B146

Ø	l	h	l	l	l
6 mm	100 mm	30 mm	105 mm	5	B146.006.100
6 mm	100 mm	30 mm	105 mm	1	SB146.006.100

BahcoFit syl i kort modell med gummigrepp, 6 mm



B195Awl

Ø	l	h	l	l	l
4 mm	50 mm	33 mm	60 mm	5	B195.006.050
4 mm	50 mm	33 mm	60 mm	1	SB195.006.050

BahcoFit sexkants hylsskruvmejsel med gummigrepp, 4–14 mm



B198

Ø	l	h	l	l	l
4 mm	125 mm	24,5 mm	95 mm	5	B198.040.125
4,5 mm	125 mm	24,5 mm	95 mm	5	B198.045.125
5 mm	150 mm	30 mm	105 mm	5	B198.050.150
5,5 mm	150 mm	30 mm	105 mm	5	B198.055.150
6 mm	150 mm	30 mm	105 mm	5	B198.060.150
6 mm	150 mm	34 mm	117 mm	5	B198.060.150F
7 mm	150 mm	34 mm	117 mm	5	B198.070.150
7 mm	150 mm	34 mm	117 mm	5	B198.070.150F
8 mm	150 mm	34 mm	117 mm	5	B198.080.150
8 mm	150 mm	34 mm	117 mm	5	B198.080.150F
9 mm	150 mm	34 mm	117 mm	5	B198.090.150
10 mm	150 mm	34 mm	117 mm	5	B198.100.150
11 mm	150 mm	34 mm	117 mm	5	B198.110.150
12 mm	150 mm	34 mm	117 mm	5	B198.120.150
13 mm	150 mm	34 mm	117 mm	5	B198.130.150
14 mm	150 mm	34 mm	117 mm	5	B198.140.150
4 mm	125 mm	24,5 mm	95 mm	1	SB198.040.125
4,5 mm	125 mm	24,5 mm	95 mm	1	SB198.045.125
5 mm	150 mm	30 mm	105 mm	1	SB198.050.150
5,5 mm	150 mm	30 mm	105 mm	1	SB198.055.150
6 mm	150 mm	30 mm	105 mm	1	SB198.060.150
6 mm	150 mm	34 mm	117 mm	1	SB198.060.150F
7 mm	150 mm	34 mm	117 mm	1	SB198.070.150
7 mm	150 mm	34 mm	117 mm	1	SB198.070.150F
8 mm	150 mm	34 mm	117 mm	1	SB198.080.150
8 mm	150 mm	34 mm	117 mm	1	SB198.080.150F
9 mm	150 mm	34 mm	117 mm	1	SB198.090.150
10 mm	150 mm	34 mm	117 mm	1	SB198.100.150
11 mm	150 mm	34 mm	117 mm	1	SB198.110.150
12 mm	150 mm	34 mm	117 mm	1	SB198.120.150
13 mm	150 mm	34 mm	117 mm	1	SB198.130.150
14 mm	150 mm	34 mm	117 mm	1	SB198.140.150

BahcoFit skruvmejselsats, med gummigrepp – 2 delar



B219.002

2	1	B219.002
---	---	----------

B191.040.100

B192.001.100



BahcoFit skruvmejselsats för spår- och Phillips-skruv med gummigrepp – 2 delar



B219.012



2

1 B219.012

B190.055.125



B192.002.125



Sats med skruvmejslar med gummigrepp, för spår- och Phillips-skruv – 4 st.



B219.004



4

1 B219.004

B191.030.100, B191.055.125



B192.001.100, B192.002.125



BahcoFit sats med skruvmejslar med gummigrepp – 5 st.



B219.005



5

1 B219.005

B191.030.075, B191.040.100



B190.055.125



B192.001.100, B192.002.125



BahcoFit skruvmejselsats för spår- och Pozidriv-skruv, med gummigrepp – 5 delar



B219.015



5

1 B219.015

B191.030.075, B191.040.100



B190.055.125



B193.001.100, B193.002.125



BahcoFit sats med skruvmejslar med gummigrepp, för Torx®-skruv – 5 st.



B219.025



5

1 B219.025

B194.010.075, B194.015.100, B194.020.100, B194.025.125, B194.030.150



BahcoFit skruvmejselsats för Torx®-skruv med centrumpets och gummigrepp – 5 st



B219.035



5

1 B219.035

B141.010.075, B141.015.100, B141.020.100, B141.025.125, B141.030.150



BahcoFIT skruvmejselsats med gummigrepp – 6 st.



B219.006



6

1 B219.006

B191.030.075, B191.040.100



B190.055.125, B190.065.125



B192.001.100, B192.002.125



Sats med skruvmejslar med gummigrepp, för spår- och Pozidriv-skruv – 6 st.



B219.016



6

1 B219.016

B191.030.075, B191.040.100

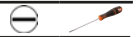

B190.055.125, B190.065.125



B193.001.100, B193.002.125



Sats med skruvmejslar med gummigrepp, för spår-, Phillips- och Pozidriv-skruv – 6 st.



B219.026



6

1 B219.026

B191.030.075, B191.040.100



B192.001.100, B192.002.125



B193.001.100, B193.002.125



BahcoFit skruvmejselsats för Pozidriv-, Torx®-skruv, med gummigrepp – 7 delar



B219.007



7

1 B219.007

B193.001.100, B193.002.125



B194.010.075, B194.015.100, B194.020.100, B194.025.125, B194.030.150



BahcoFit skruvmejselsats för spår- och Phillips-skruv, med gummigrepp – 7 delar



B219.017



7

1 B219.017

B191.035.100, B191.040.100



B190.055.125, B190.065.150, B190.080.175



B192.001.100, B192.002.125



BahcoFit skruvmejselsats för Torx®-skruv, med gummigrepp – 7 st



B219.027



7

1 B219.027

B194.010.075, B194.015.100, B194.020.100, B194.025.125,
B194.027.125, B194.030.150, B194.040.150



BahcoFit skruvmejselsats för spår- och Phillips-skruv, med gummigrepp – 8 delar



B219.008



8

1 B219.008

B191.040.100, B191.055.125



B190.065.150, B190.080.175



B192.001.100, B192.002.125



B195.060.025



B195.002.025



BahcoFit sats med skruvmejslar med gummigrepp, för spår-, Phillips-, Pozidriv- och Torx®-skruv – 10 delar



B219.110



10

1 B219.110

B190.055.100



B192.002.125



B193.002.125



B194.010.075, B194.015.100, B194.020.100



B196.025.075, B196.040.100



B142.001.080



806-1-1



BahcoFit sats med skruvmejslar med gummigrepp, för Torx®-skruv – 10 delar



B219.210



10 4.5 x 33 x 17 mm 1 B219.210

B194.006.075, B194.008.075, B194.009.075, B194.010.075,
B194.015.100, B194.020.100, B194.025.125, B194.027.125,
B194.030.150, B194.040.150



BahcoFit skruvmejselsats för spår-, Phillips-, Pozidriv- och Robertson-skruv, med gummigrepp – 10 delar



B219.010



10 1 B219.010

B191.030.075



B190.055.100, B190.065.125, B190.080.150



B192.001.100, B192.002.125, B192.003.150



B195.902.025



B144.001.100, B144.002.125



SKRUVMEJSLAR MED GUMMIGREPP

Spårskruvmejsel, rak med gummigrepp, 0,6–1,6 mm x 25–200 mm



611



Skruvmejsel	Skruvmejsel	Skruvmejsel	Skruvmejsel	Skruvmejsel	Skruvmejsel
3.5 mm	75 mm	25 mm	80 mm	10	611-3.5-75
3.5 mm	100 mm	25 mm	80 mm	10	611-3.5-100
4.0 mm	75 mm	25 mm	80 mm	10	611-4-75
4.0 mm	100 mm	25 mm	80 mm	10	611-4-100
5.5 mm	100 mm	30 mm	97 mm	10	611-5.5-100
5.5 mm	125 mm	30 mm	97 mm	10	611-5.5-125
6.5 mm	25 mm	35 mm	60 mm	10	611-6.5-25
6.5 mm	125 mm	35 mm	110 mm	10	611-6.5-125
6.5 mm	150 mm	35 mm	110 mm	10	611-6.5-150
8.0 mm	150 mm	35 mm	110 mm	10	611-8-150
8.0 mm	175 mm	35 mm	110 mm	10	611-8-175
10.0 mm	200 mm	35 mm	110 mm	10	611-10-200

Spårskruvmejsel, rak med gummigrepp, 0,5–1,2 mm



613



Skruvmejsel	Skruvmejsel	Skruvmejsel	Skruvmejsel	Skruvmejsel	Skruvmejsel
3.0 mm	75 mm	25 mm	80 mm	10	613-3-75
3.0 mm	100 mm	25 mm	80 mm	10	613-3-100
3.5 mm	100 mm	25 mm	80 mm	10	613-3.5-100
4.0 mm	100 mm	25 mm	80 mm	10	613-4-100
4.0 mm	125 mm	25 mm	80 mm	10	613-4-125
5.5 mm	150 mm	30 mm	97 mm	10	613-5.5-150
6.5 mm	150 mm	35 mm	110 mm	10	613-6.5-150



Skruvmejsel för Phillips®-skruv med gummigrepp PH0-PH3



615



PH 0	75 mm	25 mm	80 mm	10	615-0-75
PH 1	100 mm	30 mm	97 mm	10	615-1-100
PH 2	25 mm	35 mm	60 mm	10	615-2-25
PH 2	125 mm	35 mm	110 mm	10	615-2-125
PH 3	150 mm	35 mm	110 mm	10	615-3-150

Skruvmejslar för Pozidriv®-skruv med gummigrepp, PZ0-PZ3



616



PZ 0	75 mm	25 mm	80 mm	10	616-0-75
PZ 1	100 mm	30 mm	97 mm	10	616-1-100
PZ 2	125 mm	35 mm	110 mm	10	616-2-125
PZ 3	150 mm	35 mm	110 mm	10	616-3-150

Torx®-skruvmejsel med gummigrepp, T10-T40



618



T 10	75 mm	25 mm	80 mm	10	618-10-75
T 15	100 mm	25 mm	80 mm	10	618-15-100
T 20	100 mm	25 mm	80 mm	10	618-20-100
T 25	125 mm	30 mm	97 mm	10	618-25-125
T 27	125 mm	30 mm	97 mm	10	618-27-125
T 30	150 mm	35 mm	110 mm	10	618-30-150
T 40	150 mm	35 mm	110 mm	10	618-40-150

Sats med skruvmejslar med gummigrepp, för spår- och Phillips-skruv - 3 st



600-3



3	1	600-3

613-3-100	
611-5.5-125	
615-1-100	

Sats med skruvmejslar med gummigrepp, för spår- och Phillips-skruv - 4 st



602-4-LA



4	1	602-4-LA

613-3-100	
611-5.5-100	
615-1-100, 615-2-125	

Sats med skruvmejslar för spår-, Phillips-skruv, med gummigrepp - 5 st



604-5



5	1	604-5

613-3-100



611-4-100, 611-6.5-125



615-1-100, 615-2-125



TORX®-skruvmejselsats med gummigrepp - 5 st



612-5



5

1 612-5

618-10-75, 618-15-100, 618-20-100, 618-25-125, 618-30-150



Sats med skruvmejslar för spårskruv, Phillips-skruv, Pozidriv®-skruv, med gummigrepp, 3 - 4 mm, PH1-PH2, PZ1-PZ2 - 6 st



605-6



6

1 605-6

613-3-75, 613-4-100



615-1-100, 615-2-125



616-1-100, 616-2-125



Sats med 6 skruvmejslar med tvåkomponentshandtag, för spårskruv 3, 4, 5,5, 6,5 mm och Phillips®-skruv PH1, PH2 - 6 st.



606-6



6

1 606-6

611-5.5-100, 611-6.5-125



613-3-75, 613-4-100



615-1-100, 615-2-125



Sats med skruvmejslar för spårskruv/Pozidriv®-skruv med gummigrepp - 6 st



610-6



6

1 610-6

611-5.5-100, 611-6.5-125



613-3-75, 613-4-100



616-1-100, 616-2-125



Sats med skruvmejslar för spår-, Phillips-, Pozidriv- och Robertson-skruv med gummigrepp – 10 st.



605-10-PC-AU



10



1 605-10-PC-AU

Inkluderar Robertson R1x100; R2x100 och stubbmejsel PZ2 X 25

611-5.5-100, 611-6.5-125, 611-8-150



613-3-75



615-1-100, 615-2-125, 615-3-150



SKRUVMEJSLAR MED GREPP MED SPÄRRFUNKTION

1/4" spärrskruvmejsel för bits



808050



1/4"



125 mm



41,6 mm



123 mm



50 808050



Bitssats 1/4" för spår-, Phillips®, Pozidriv-, Torx®, sexkants- och insexskruv, samt bitsspärrskruvmejsel – 36 delar



59/S36BCR



36



43 x 135 x 215 mm



6 59/S36BCR



Spärrskruvmejsel med LED-lampa inkl. spår-, Phillips®- och Pozidriv-skruv



808050L



1/4 in



10x35 mm



808050L



25 808050L

1 808050L-SP1



1/4" spärrskruvmejsel för bits med pistolgrepp



808050P



1/4 in



135 mm



40 mm



125 mm



50 808050P



Sats med spärrskruvmejsel med pistolgrepp, för 1/4" bits – 25 delar



808050P-



70 x 158 x 285 mm

10 808050P-25

1/4" spärrskruvmejsel med T-handtag för bits, kort modell



808050TS



1/4 in 68 mm 91 mm 63.5 mm 1 808050TS

1/4" spärrskruvmejsel för bits, kort modell



808050S



1/4 in 68 mm 41 mm 69 mm 25 808050S

Spärrskruvmejselsats, kort modell – 18 delar



808050S-18



46 x 130 x 195 mm

30 808050S-18

Spärrskruvmejselsats, kort modell – 18 och 22 delar



808050S-22



46 x 130 x 195 mm

30 808050S-22



SKRUVMEJSLAR MED PRECISIONSGREPP

Spårskruvmejsel med precisionsgrepp 0,18–0,8 mm



700

Spår	Längd	Skruv	Skruv	Skruv	Skruv
1 mm	50 mm	14 mm	87 mm	5	700-1-50
1.2 mm	50 mm	14 mm	87 mm	5	700-1.2-50
1.5 mm	50 mm	14 mm	87 mm	5	700-1.5-50
1.8 mm	50 mm	14 mm	87 mm	5	700-1.8-50
2 mm	50 mm	14 mm	87 mm	5	700-2-50
2.5 mm	50 mm	14 mm	87 mm	5	700-2.5-50
3 mm	50 mm	14 mm	87 mm	5	700-3-50
3 mm	100 mm	14 mm	87 mm	5	700-3-100
3 mm	200 mm	14 mm	87 mm	5	700-3-200
3.5 mm	75 mm	14 mm	87 mm	5	700-3.5-75
4 mm	75 mm	14 mm	87 mm	5	700-4-75
4 mm	250 mm	14 mm	87 mm	5	700-4-250

Skruvmejsel för Phillips®-skruv med precisionsgrepp PH00-PH1



701

Skruv	Längd	Skruv	Skruv	Skruv	Skruv
PH 00	50 mm	14 mm	87 mm	5	701-00-50
PH 0	50 mm	14 mm	87 mm	5	701-0-50
PH 0	200 mm	14 mm	87 mm	5	701-0-200
PH 1	75 mm	14 mm	87 mm	5	701-1-75
PH 1	250 mm	14 mm	87 mm	5	701-1-250

Skruvmejslar för Pozidriv®-skruv med precisionsgrepp, PZ0–PZ1



702

Skruv	Längd	Skruv	Skruv	Skruv	Skruv
PZ 0	50 mm	14 mm	87 mm	5	702-0-50
PZ 1	75 mm	14 mm	87 mm	5	702-1-75

Torx®-skruvmejsel med precisionsgrepp, T4–T20



703

Skruv	Längd	Skruv	Skruv	Skruv	Skruv
T 4	50 mm	14 mm	87 mm	5	703-4-50
T 5	50 mm	14 mm	87 mm	5	703-5-50
T 6	50 mm	14 mm	87 mm	5	703-6-50
T 7	50 mm	14 mm	87 mm	5	703-7-50
T 8	50 mm	14 mm	87 mm	5	703-8-50
T 9	50 mm	14 mm	87 mm	5	703-9-50
T 10	50 mm	14 mm	87 mm	5	703-10-50
T 15	75 mm	14 mm	87 mm	5	703-15-75
T 20	75 mm	14 mm	87 mm	5	703-20-75

Insexskruvmejslar med precisionsgrepp 1,5-3 mm 3/32"



704

Skruv	Längd	Skruv	Skruv	Skruv	Skruv
1.5	50 mm	14 mm	87 mm	5	704-1.5-50
2	50 mm	14 mm	87 mm	5	704-2-50
2.5	50 mm	14 mm	87 mm	5	704-2.5-50
3	75 mm	14 mm	87 mm	5	704-3-75
3/32	75 mm	14 mm	87 mm	5	704Z-3/32

Sats med precisionsskrivmejslar med precisionsgrepp, spår 1,5, 2, 2,5, 3 mm och Phillips® PH0, PH1 – 6 st.



706-1

Skruv	Längd	Skruv	Skruv	Skruv	Skruv
X					

6

1 706-1

700-2-50, 700-2.5-50, 700-1.5-50, 700-3-50



701-0-50, 701-1-75



Sats med skruvmejslar för spår-/Phillips®-skruv med precisionsgrepp – 1-1,8 mm/PH00-PH0 – 6 st



706-2



6

1 706-2

700-1.5-50, 700-1.2-50, 700-1-50, 700-1.8-50



701-00-50, 701-0-50



Sats med skruvmejslar för spårskruv med precisionsgrepp, 1-2,5 mm, 6 st



706-3



6

1 706-3

700-2.5-50, 700-2-50, 700-1.8-50, 700-1.5-50, 700-1.2-50, 700-1-50



Skruvmejselsats för spårskruv, Phillips-, Pozidriv-, Torx®-skruv, med precisionsgrepp – 7 st



706-4



7

1 706-4

700-2.5-50, 700-3.5-75, 700-1.5-50



701-1-75, 701-0-50



703-8-50, 703-6-50



Sats med skruvmejslar med precisionsgrepp, för spår-, Phillips®, Pozidriv-, Torx®- och insexskruv – 24 st.



706-5



24

1 706-5

700-3-50, 700-2-50, 700-3.5-75, 700-4-75, 700-1.5-50, 700-1.2-50, 700-1-50, 700-1.8-50



701-00-50, 701-0-50, 701-1-75



702-1-75, 702-0-50



703-6-50, 703-9-50, 703-10-50, 703-7-50, 703-8-50, 703-15-75, 703-20-75



704-2.5-50, 704-3-75, 704-1.5-50, 704-2-50



Skruvmejsel för spårskruv, med precisionsgrepp och 4 utbytbara klingor



510034



0.25x1.5; 0.3x2; 0.4x2.5; 0.5x3 8,5 mm 10 510034

0.25x1.5; 0.3x2.0; 0.4x2.5; 0.5x3.0mm

Urmakarskrvmejsel för spårskruv med precisionsgrepp, 2,5–4,5 mm



2784



2.5 mm	6 mm	100 mm	1	2784-2.5
3.5 mm	6 mm	104 mm	1	2784-3.5
4.5 mm	10 mm	110 mm	1	2784-4.5

Sats med spårskruvmejslar med precisionsgrepp, 0,6–2,5 mm – 5 st.



98505



5 5 98505

0.6; 0.8; 1.0; 1.5; 2.5

Sats med spårskruvmejslar med precisionsgrepp, 1,0–3,5 mm – 6 st.



510031

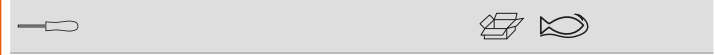

6 5 510031

1.0; 1.5; 2.0; 2.5; 3.0; 3.5

Sats med skruvmejslar med precisionsgrepp för Phillips®-skruv, PH000–PH0 – 3 st.



510033



3 5 510033

PH000; PH00; PH0

SKRUVMEJSLAR MED T-HANDTAGSGREPP

Insexskruvmejslar med T-handtagsgrepp, 2–10 mm



900T



2 mm	100 mm	50 mm	85 mm	5	900T-020-100
2.5 mm	100 mm	50 mm	85 mm	5	900T-025-100
3 mm	100 mm	50 mm	85 mm	5	900T-030-100
4 mm	138 mm	50 mm	85 mm	5	900T-040-150

5 mm	138 mm	60 mm	105 mm	5	900T-050-150
6 mm	185 mm	60 mm	105 mm	5	900T-060-200
8 mm	185 mm	60 mm	105 mm	5	900T-080-200
10 mm	185 mm	60 mm	105 mm	5	900T-100-200

Torx®-skruvmejsel med T-handtagsgrepp, T6-T50



901T



T 6	100 mm	50 mm	85 mm	5	901T-006-100
T 7	100 mm	50 mm	85 mm	5	901T-007-100
T 8	100 mm	50 mm	85 mm	5	901T-008-100
T 9	100 mm	50 mm	85 mm	5	901T-009-100
T 10	100 mm	50 mm	85 mm	5	901T-010-100
T 15	138 mm	50 mm	85 mm	5	901T-015-150
T 20	138 mm	50 mm	85 mm	5	901T-020-150
T 25	138 mm	60 mm	105 mm	5	901T-025-150
T 27	138 mm	60 mm	105 mm	5	901T-027-150
T 30	185 mm	60 mm	105 mm	5	901T-030-200
T 40	185 mm	60 mm	105 mm	5	901T-040-200
T 45	185 mm	60 mm	105 mm	5	901T-045-200
T 50	185 mm	60 mm	105 mm	5	901T-050-200

Sexkants hylsskruvmejsel med T-handtagsgrepp 5–13 mm



902T



5 mm	136 mm	50 mm	85 mm	5	902T-050-150
5.5 mm	136 mm	50 mm	85 mm	5	902T-055-150
6 mm	136 mm	50 mm	85 mm	5	902T-060-150
7 mm	160 mm	60 mm	105 mm	5	902T-070-175
8 mm	160 mm	60 mm	105 mm	5	902T-080-175
9 mm	160 mm	60 mm	105 mm	5	902T-090-175
10 mm	160 mm	60 mm	105 mm	5	902T-100-175
11 mm	160 mm	60 mm	105 mm	5	902T-110-175
12 mm	160 mm	60 mm	105 mm	5	902T-120-175
13 mm	160 mm	60 mm	105 mm	5	902T-130-175

T-vridhandtag för 1/4" hylsor. Längd: 45 mm



905T



1/4"	45 mm	60 mm	105 mm	5	905T-060-100

Sats med insexskruvmejslar med T-handtagsgrepp – 6 st.



903T-1



X		
6	1	903T-1

900T-030-100, 900T-040-150, 900T-050-150, 900T-060-200, 900T-080-200, 900T-100-200



Sats med Torx®-skruvmejsel, T-handtagsgrepp T10-T40 – 6 delar



903T-2



X		
6	1	903T-2

901T-015-150, 901T-020-150, 901T-010-100, 901T-030-200, 901T-040-200, 901T-025-150



Sats med sexkants hylsskruvmejsel med T-handtag, 5–13 mm, 6 delar



903T-3

6	1	903T-3

902T-060-150, 902T-070-175, 902T-050-150, 902T-080-175, 902T-100-175, 902T-130-175

SKRUVMEJSLAR MED 1/4" BITSHÅLLARE

1/4" x 125 mm magnetiska bitshållare



B705

1/4" in	125 mm	30 mm	105 mm	5 B705.1/4.125
1/4" in	125 mm	30 mm	105 mm	1 SB705.1/4.125

1/4" bitshållare för insexskruv med T-handtag



904T

1/4 in	150 mm	5 904T-060-150

Bitsskruvmejsel med 1/4" bitshållare för Phillips-/Pozidriv-/spår-/Torx®-skruv



808050A/TORX

1/4 in	115 mm	40 mm	115 mm	1 808050A
1/4 in	115 mm	40 mm	115 mm	50 808050TORX

SKRUVMEJSLAR MED TRÄ- ELLER PLASTGREPP

Spårskruvmejsel, rak med trähandtag, 0,6–1,6 mm



9710

3.5 mm	75 mm	22 mm	95 mm	10 9710-3.5-75
5.5 mm	100 mm	24 mm	100 mm	10 9710-5.5-100
6.5 mm	125 mm	27 mm	110 mm	10 9710-6.5-125
8.0 mm	150 mm	30 mm	120 mm	5 9710-8-150
10.0 mm	175 mm	32 mm	125 mm	5 9710-10-175

Skruvmejslar för Phillips®-skruv, med trähandtag, PH1–PH3



9778

PH 1	80 mm	24 mm	100 mm	10 9778-1
PH 2	110 mm	27 mm	110 mm	10 9778-2
PH 3	150 mm	30 mm	120 mm	5 9778-3

Skruvmejslar för Pozidriv-skruv, med trähandtag PZ1-PZ2



9778PZD

PZ 1	80 mm	24 mm	100 mm	10	9778PZD-1	
PZ 2	110 mm	27 mm	110 mm	10	9778PZD-2	

Sats med skruvmejsel för spårskruv och Phillips-skruv, med trähandtag – 6 st



9710/S6

6				1	9710/S6

0,8x4,5x90

9710-4.5-90

9710-5.5-100, 9710-6.5-125, 9710-8-150

9778-1, 9778-2

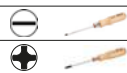

Skruvmejsel med vändbar klinga för spår- och Phillips-skrivar



1019/1067

4,5 mm	PH 1		10	1067			
6 mm	PH 2		10	1019			

Kombinationsskruvmejsel med vändbar klinga och plasthandtag, spår- och Phillips®-skruv, 1 mm/PH2



8052

PH 2	80 mm	28 mm	110 mm	5	8052

Kort skruvmejsel med vändbar klinga för spår- och Phillips-skrivar



1016

6 mm	PH 2		10	1016		

Skruvmejselsats med vändbara klingor för spårskruv och Phillips-skruv



6

PH 0, PH 1, PH 2				3,5-5,0-6,5 mm			1	6



Spårskruvmejsel, rak med stöttåligt grepp, 2,5–250 mm



9715



14.0 mm	250 mm	32 mm	140 mm	5	9715-14-250	

Precisionsskruvmejsel med plasthandtag 0,4–0,5 mm x 63–80 mm



7372I



2.0 mm	63 mm	13 mm	80 mm	10	7372I-2-63	
2.5 mm	75 mm	13 mm	80 mm	10	7372I-2.5-75	
3.0 mm	80 mm	13 mm	80 mm	10	7372I-3-80	

SPÄNNINGSPROVARE

Spänningsprovare/isolerad skruvmejsel för 15–250 V



806



3.0 mm	65 mm	16 mm	75 mm	6	806-1-1	
3.5 mm	100 mm	17,5 mm	90 mm	6	806-1-2	

Spänningsprovare med handtag i transparent plast

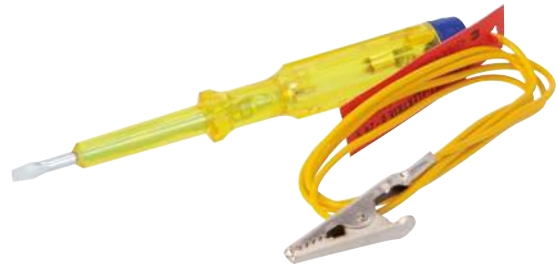

806-1-3



3 mm	45 mm	16 mm	75 mm	6	806-1-3	

Isolerade spänningsprovare 150 V till 250 V



8045VDE



3.5 mm	77 mm	14 mm	92 mm	10	8045VDE	

Isolerade spänningsprovare, lätt modell, 150 V till 250 V



8045LVDE



3.5 mm	42 mm	16 mm	90 mm	10	8045LVDE	

TILLBEHÖR

Verktyg för magnetisering/avmagnetisering av skruvmejslar, pincetter och andra verktyg av stål



M780



29 x 52 x 50 mm



1 M780

Magnetisering/avmagnetisering av skruvmejslar, pincetter och t.ex. saxar



M781



22 x 125 x 40 mm



5 M781





BAHCO



Vinkelskruvmejslar



Insexnycklar i metriska dimensioner, förnicklade



1998M

Hexagon Size	Length (L)	Quantity	Part Number
1.5 mm	47 mm	10	1998M-1.5
2 mm	52 mm	10	1998M-2
2.5 mm	59 mm	10	1998M-2.5
3.0 mm	66 mm	10	1998M-3
4.0 mm	74 mm	10	1998M-4
5.0 mm	85 mm	10	1998M-5
6.0 mm	96 mm	10	1998M-6
7.0 mm	102 mm	10	1998M-7
8.0 mm	108 mm	10	1998M-8
9.0 mm	114 mm	5	1998M-9
10 mm	122 mm	10	1998M-10
12.0 mm	137 mm	5	1998M-12
14.0 mm	154 mm	1	1998M-14
17.0 mm	177 mm	1	1998M-17
19.0 mm	199 mm	1	1998M-19
22.0 mm	222 mm	1	1998M-22

Insexnyckelsats i metriska dimensioner, förnicklad yta-6 delar



1998M/6T

Hexagon Size	Quantity	Part Number
2, 2.5, 3, 4, 5, 6 mm	6	1 1998M/6T

1998M-4, 1998M-5, 1998M-6, 1998M-2.5, 1998M-2, 1998M-3

Insexnyckelsats i metriska dimensioner, förnicklade-8 delar



1998M/8T

Hexagon Size	Quantity	Part Number
2, 2.5, 3, 4, 5, 6, 7, 8 mm	8	1 1998M/8T

1998M-3, 1998M-2, 1998M-6, 1998M-7, 1998M-4, 1998M-5, 1998M-8, 1998M-2.5

Insexnyckelsats i metriska dimensioner, förnicklad yta-10 delar



1998M/10T

Hexagon Size	Quantity	Part Number
2, 2.5, 3, 4, 5, 6, 7, 8, 9, 10 mm	10	1 1998M/10T

1998M-5, 1998M-4, 1998M-7, 1998M-6, 1998M-2, 1998M-3, 1998M-2.5, 1998M-8, 1998M-9, 1998M-10

Insexnyckelsats i metriska dimensioner, förnicklade-11 delar



1998M/11T

Hexagon Size	Quantity	Part Number
2, 2.5, 3, 4, 5, 6, 7, 8, 9, 10, 12 mm	11	1 1998M/11T

1998M-5, 1998M-4, 1998M-7, 1998M-6, 1998M-2, 1998M-3, 1998M-2.5, 1998M-8, 1998M-9, 1998M-10, 1998M-12

Insexnyckelsats i metriska dimensioner, förnicklade-15 delar



1998M/15T

Hexagon Size	Quantity	Part Number
2, 2.5, 3, 4, 5, 6, 7, 8, 9, 10, 12, 14, 17, 19, 22 mm	15	1 1998M/15T

1998M-2, 1998M-5, 1998M-4, 1998M-7, 1998M-6, 1998M-3, 1998M-2.5, 1998M-14, 1998M-17, 1998M-19, 1998M-22, 1998M-8, 1998M-9, 1998M-10, 1998M-12

Insexnyckelsats, förnicklad med kompakt tvåkomponentshållare, metrisk-9 delar



BE-9878

Hexagon Size	Quantity	Part Number
1.5, 2, 2.5, 3, 4, 5, 6, 8, 10 mm	9	1 BE-9878

1998M-1.5, 1998M-2.5, 1998M-2, 1998M-3, 1998M-4, 1998M-5, 1998M-6, 1998M-8, 1998M-10

Insexnyckelsats i metriska dimensioner, förnicklade-8 delar



1998M/8R

Hexagon Size	Quantity	Part Number
2, 2.5, 3, 4, 5, 6, 7, 8 mm	8	1 1998M/8R

Insexnyckelsats i metriska dimensioner, förzinkade-7 delar



1999M/7H

Hexagon Size	Quantity	Part Number
2.5 3 4 5 6 8 10 mm	7	1 1999M/7H

2.5, 3, 4, 5, 6, 8, 102.5 3 4 5 6 8 10 mm

Sats med långa insexnycklar med kula, förnicklade-12 delar, tum-storlekar



BE-9880

--	--	--	--

0.050; 1/16; 5/64; 3/32; 7/64; 1/8; 9/64; 5/32; 3/16; 7/32; 1/4; 5/16 in	12	3	BE-9880
---	----	---	---------

0.050; 1/16; 5/64; 3/32; 7/64; 1/8; 9/64; 5/32; 3/16; 7/32; 1/4; 5/16

Insexnyckel i metriska dimensioner, med svartoxiderad yta



1995M

--	--	--	--

0.9 mm	33 mm	10	1995M-0.9
1.5 mm	47 mm	10	1995M-1.5
2.0 mm	52 mm	10	1995M-2
2.5 mm	59 mm	10	1995M-2.5
3.0 mm	66 mm	10	1995M-3
4.0 mm	74 mm	10	1995M-4
5.0 mm	85 mm	10	1995M-5
6.0 mm	96 mm	10	1995M-6
7.0 mm	102 mm	10	1995M-7
8.0 mm	108 mm	10	1995M-8
9.0 mm	114 mm	10	1995M-9
10 mm	122 mm	10	1995M-10
12 mm	137 mm	10	1995M-12
14 mm	154 mm	10	1995M-14
17 mm	177 mm	10	1995M-17
19 mm	199 mm	10	1995M-19
22 mm	222 mm	10	1995M-22

Insexnycklar med svartoxiderad yta, tum-storlekar



1995Z

--	--	--	--

1/16 in	47 mm	10	1995Z-1/16
5/64 in	52 mm	10	1995Z-5/64
3/32 in	59 mm	10	1995Z-3/32

1/8 in	66 mm	10	1995Z-1/8
5/32 in	74 mm	10	1995Z-5/32
3/16 in	85 mm	10	1995Z-3/16
7/32 in	91 mm	10	1995Z-7/32
1/4 in	96 mm	10	1995Z-1/4
5/16 in	108 mm	10	1995Z-5/16
3/8 in	122 mm	10	1995Z-3/8
7/16 in	129 mm	10	1995Z-7/16
1/2 in	145 mm	10	1995Z-1/2
5/8 in	168 mm	10	1995Z-5/8
3/4 in	199 mm	10	1995Z-3/4

Insexnycklar i metriska dimensioner, med svartoxiderad yta-6 delar



1995M/

--	--	--	--

2, 2.5, 3, 4, 5, 6 mm	6	1	1995M/6T
-----------------------	---	---	----------

1995M-2, 1995M-2.5, 1995M-6, 1995M-5, 1995M-4, 1995M-3

Insexnyckelsats, metriska dimensioner, med svartoxiderad yta-8 delar



1995M/8T

--	--	--	--

2, 2.5, 3, 4, 5, 6, 7, 8 mm	8	1	1995M/8T
-----------------------------	---	---	----------

1995M-2.5, 1995M-2, 1995M-6, 1995M-5, 1995M-4, 1995M-3, 1995M-7, 1995M-8

Insexnyckelsats, metriska dimensioner, med svartoxiderad yta-10 delar



1995M/10T

--	--	--	--

2, 2.5, 3, 4, 5, 6, 7, 8, 9, 10 mm	10	1	1995M/10T
------------------------------------	----	---	-----------

1995M-2.5, 1995M-2, 1995M-6, 1995M-5, 1995M-4, 1995M-3, 1995M-9, 1995M-10, 1995M-7, 1995M-8

Insexnyckelsats, metriska dimensioner, med svartoxiderad yta-11 delar



1995M/11T

--	--	--	--

2, 2.5, 3, 4, 5, 6, 7, 8, 9, 10, 12 mm	11	1	1995M/11T
--	----	---	-----------

1995M-2, 1995M-6, 1995M-5, 1995M-4, 1995M-2.5, 1995M-3, 1995M-9, 1995M-10, 1995M-7, 1995M-8, 1995M-12

Insexnyckelsats, metriska dimensioner, med svartoxiderad yta-15 delar



1995M/15T

--	--	--	--

2, 2.5, 3, 4, 5, 6, 7, 8, 9, 10, 12, 14, 17, 19, 22 mm	15	1	1995M/15T
--	----	---	-----------

1995M-2.5, 1995M-2, 1995M-6, 1995M-5, 1995M-4, 1995M-3, 1995M-9, 1995M-10, 1995M-7, 1995M-8, 1995M-17, 1995M-19, 1995M-12, 1995M-14, 1995M-22



Insexnyckelsats i metriska dimensioner, med kompakt tvåkomponentshållare–9 delar



BE-9578

1.5, 2, 2.5, 3, 4, 5, 6, 8, 10 mm	9	1	BE-9578

1995M-2,5, 1995M-2, 1995M-1.5, 1995M-6, 1995M-5, 1995M-4, 1995M-3, 1995M-8, 1995M-10

Sats med metriska insexnycklar i hållare med svartoxiderad yta och tvåkomponentshandtag–7 delar



BE-9777B

2.5 3 4 5 6 8 10 mm	7	6	BE-9777B

2.5, 3, 4, 5, 6, 8, 10 mm

Insexnyckelsats, metrisk, med svartoxiderad yta 1,5 mm–6 mm–7 delar



BE-9776

1.5 2 2.5 3 4 5 6 mm	6	6	BE-9776

1.5, 2, 2.5, 3, 4, 5, 6 mm

Sats med metriska insexnycklar i hållare, svartoxiderad yta, 2,5 mm–10 mm, 7 delar



BE-9777

2.5 3 4 5 6 8 10 mm	7	6	BE-9777

2.5, 3, 4, 5, 6, 8, 10 mm

Insexnyckelsats, med svartoxiderad yta, tum-storlekar–10 delar



1995Z/

1/16, 5/64, 3/32, 1/8, 5/32, 3/16, 7/32, 1/4, 5/16, 3/8 in	10	1	1995Z/10T

1995Z-1/16, 1995Z-5/64, 1995Z-3/32, 1995Z-1/8, 1995Z-5/32, 1995Z-3/16, 1995Z-3/8, 1995Z-7/32, 1995Z-1/4, 1995Z-5/16

Insexnyckelsats, med svartoxiderad yta, tum-storlekar–12 delar



1995Z/12T

1/16, 5/64, 3/32, 1/8, 5/32, 3/16, 7/32, 1/4, 5/16, 3/8, 7/16, 1/2 in	12	1	1995Z/12T

1995Z-1/16, 1995Z-5/64, 1995Z-3/32, 1995Z-1/8, 1995Z-5/32, 1995Z-3/16, 1995Z-1/2, 1995Z-7/16, 1995Z-3/8, 1995Z-7/32, 1995Z-1/4, 1995Z-5/16

Insexnyckelsats, med svartoxiderad yta, tum-storlekar–7 delar



BE-9787

3/32 1/8 5/32 3/16 1/4 5/16 3/8 in	7	6	BE-9787

Långa insexnycklar i metriska dimensioner, med svartoxiderad yta för 1,5–14 mm



1995LM

1.5 mm	91 mm	10	1995LM-1.5
2 mm	102 mm	10	1995LM-2
2.5 mm	114 mm	10	1995LM-2,5
3.0 mm	129 mm	10	1995LM-3
4.0 mm	144 mm	10	1995LM-4
5.0 mm	165 mm	10	1995LM-5
6.0 mm	186 mm	10	1995LM-6
7.0 mm	197 mm	10	1995LM-7
8.0 mm	208 mm	10	1995LM-8
9.0 mm	219 mm	10	1995LM-9
10 mm	234 mm	10	1995LM-10
12 mm	262 mm	10	1995LM-12
14 mm	294 mm	10	1995LM-14

Sats med långa insexnycklar, metriska med svartoxiderad yta–9 delar



BE-9586

1.5, 2, 2.5, 3, 4, 5 mm	6	1	BE-9586

1995LM-1.5, 1995LM-3, 1995LM-2,5, 1995LM-2, 1995LM-4, 1995LM-5

Sats med långa insexnycklar, med kompakt tvåkomponentshållare-9 delar



BE-9588

1.5, 2, 2.5, 3, 4, 5, 6, 8, 10 mm	9	1	BE-9588

1995LM-1.5, 1995LM-2, 1995LM-2.5, 1995LM-3, 1995LM-4, 1995LM-5, 1995LM-6, 1995LM-8, 1995LM-10

Långa insexnycklar med kula och svartoxiderad yta, metrisk storlekar



1996M

1.5 mm	91 mm	10	1996M-1.5
2.0 mm	102 mm	10	1996M-2
2.5 mm	114 mm	10	1996M-2.5
3.0 mm	129 mm	10	1996M-3
4.0 mm	144 mm	10	1996M-4
5.0 mm	165 mm	10	1996M-5
6.0 mm	186 mm	10	1996M-6
8.0 mm	208 mm	10	1996M-8
10 mm	234 mm	10	1996M-10
12 mm	262 mm	10	1996M-12

Insexnyckelsats, långa med kula och färgkod, metrisk dimensioner, 9 stycken



C1997LM/9P

1.5, 2, 2.5, 3, 4, 5, 6, 8, 10 mm	9	1	C1997LM/9P

Sats med långa insexnycklar med kula, svartoxiderad yta 1,5 mm-10 mm-6 delar



BE-9765

1.5, 2, 2.5, 3, 4, 5 mm	6	3	BE-9765

1996M-1.5, 1996M-2.5, 1996M-2, 1996M-4, 1996M-3, 1996M-5

Sats med långa metrisk insexnycklar med kula, svartoxiderad yta, 9 delar



BE-9770

1.5, 2, 2.5, 3, 4, 5, 6, 8, 10 mm	9	3	BE-9770

1996M-1.5, 1996M-2.5, 1996M-2, 1996M-4, 1996M-3, 1996M-5, 1996M-6, 1996M-10, 1996M-8

Sats med långa insexnycklar med kula, metrisk, med svartoxiderad yta 1,5 mm-5 mm-6 delar



BE-9676

1.5, 2, 2.5, 3, 4, 5 mm	6	1	BE-9676

1996M-5, 1996M-4, 1996M-3, 1996M-2.5, 1996M-2, 1996M-1.5

Sats med långa metrisk insexnycklar med kula, kompakt hållare, 9 delar



BE-9678

1.5, 2, 2.5, 3, 4, 5, 6, 8, 10 mm	9	1	BE-9678

1996M-4, 1996M-5, 1996M-2.5, 1996M-3, 1996M-10, 1996M-6, 1996M-8, 1996M-2, 1996M-1.5

Sats med långa insexnycklar med kula, metrisk, kompakt tvåkomponentshållare med magnetiseringsfunktion-9 delar



BE-9688

1.5, 2, 2.5, 3, 4, 5, 6, 8, 10 mm	9	1	BE-9688

1996M-1.5, 1996M-2, 1996M-2.5, 1996M-3, 1996M-4, 1996M-5, 1996M-6, 1996M-8, 1996M-10

Insexnyckelsats med kula, metrisk, kompakt tvåkomponentshållare-7 delar



BE-9776B

2.5, 3, 4, 5, 6, 8, 10 mm	7	6	BE-9776B

2.5, 3, 4, 5, 6, 8, 10 mm



Sats med långa insexnycklar med kula, svartoxiderad yta, tum-storlekar



BE-9775



1/16, 5/64, 3/32, 1/8, 5/32, 3/16, 1/4 in 7 3 BE-9775

5/64 3/32 1/4 1/8 1/16 5/32 3/16

Sats med långa insexnycklar med kula, svartoxiderad yta-12 delar, tum-storlekar



BE-9780



0.05 1/16 5/64 3/32 7/64 1/8 9/64 5/32 3/16 7/32 1/4 5/16 in 12 3 BE-9780

0.05 1/16 5/64 3/32 7/64 1/8 9/64 5/32 3/16 7/32 1/4 5/16

Sats med långa insexnycklar med kula, tum, svartoxiderad yta-13 delar



BE-9785



0.05 1/16 5/64 3/32 7/64 1/8 9/64 5/32 3/16 7/32 1/4 5/16 3/8 in 13 3 BE-9785

0.05 1/16 5/64 3/32 7/64 1/8 9/64 5/32 3/16 7/32 1/4 5/16 3/8

TORX®

Långa vinkelskruvmejslar för Torx®-skruv, med svartoxiderad yta



1995TORX

	L	
T 6	75 mm	5 1995TORX-T6
T 7	80 mm	5 1995TORX-T7
T 8	80 mm	5 1995TORX-T8
T 9	80 mm	5 1995TORX-T9
T 10	86 mm	5 1995TORX-T10
T 15	90 mm	5 1995TORX-T15
T 20	95 mm	5 1995TORX-T20
T 25	100 mm	5 1995TORX-T25
T 27	105 mm	5 1995TORX-T27
T 30	114 mm	5 1995TORX-T30
T 40	124 mm	5 1995TORX-T40
T 45	133 mm	5 1995TORX-T45
T 50	152 mm	5 1995TORX-T50
T 55	184 mm	5 1995TORX-T55
T 60	204 mm	5 1995TORX-T60

TORX®-nyckelsats, långa med färgkod, 9 stycken



C1997TORX/9P

	X	
8, 9, 10, 15, 20, 25, 27, 30, 40	9	1 C1997TORX/9P

Sats med långa vinkelskruvmejslar för Torx®-skruv, svartoxiderad yta-4 delar



1995TORX/

	X	
10, 20, 30, 40	4	1 1995TORX/4T

1995TORX-T40, 1995TORX-T30, 1995TORX-T10, 1995TORX-T20

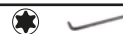

Sats med långa vinkelskruvmejslar för Torx®-skruv, svartoxiderad yta-7 delar



1995TORX/7T

	X	
10, 15, 20, 25, 27, 30, 40	7	1 1995TORX/7T

1995TORX-T20, 1995TORX-T10, 1995TORX-T15, 1995TORX-T27, 1995TORX-T25, 1995TORX-T30, 1995TORX-T40



Sats med långa vinkelskruvmejslar för Torx®-skruv, svartoxiderad yta-11 delar



1995TORX/11T

	X	
7, 9, 10, 15, 20, 25, 27, 30, 40, 45, 50	11	1 1995TORX/11T

1995TORX-T7, 1995TORX-T9, 1995TORX-T10, 1995TORX-T15, 1995TORX-T20, 1995TORX-T25, 1995TORX-T27, 1995TORX-T30, 1995TORX-T40, 1995TORX-T45, 1995TORX-T50

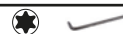

Sats med långa vinkelskruvmejslar för Torx®-skruv, svartoxiderad yta-13 delar



1995TORX/13T

☼	X	☐	☐
6, 7, 8, 9, 10, 15, 20, 25, 27, 30, 40, 45, 50	13	1	1995TORX/13T

1995TORX-T45, 1995TORX-T40, 1995TORX-T30, 1995TORX-T27, 1995TORX-T25, 1995TORX-T20, 1995TORX-T15, 1995TORX-T10, 1995TORX-T50, 1995TORX-T8, 1995TORX-T9, 1995TORX-T6, 1995TORX-T7

Sats med vinkelskruvmejslar för Torx®-skruv, med svartoxiderad yta-8 delar



BE-9575

☼	X	☐	☐
T9, T10, T15, T20, T25, T27, T30, T40	8	1	BE-9575

1995TORX-T40, 1995TORX-T30, 1995TORX-T27, 1995TORX-T25, 1995TORX-T20, 1995TORX-T15, 1995TORX-T10, 1995TORX-T9

Sats med långa vinkelskruvmejslar för Torx®-skruv, med svartoxiderad yta-8 delar



BE-9585

☼	X	☐	☐
T9, T10, T15, T20, T25, T27, T30, T40	8	1	BE-9585

1995TORX-T30, 1995TORX-T27, 1995TORX-T25, 1995TORX-T20, 1995TORX-T15, 1995TORX-T10, 1995TORX-T9, 1995TORX-T40



Sats med vinkelskruvmejslar för Torx®-skruv, svartoxiderad yta och hållare med bekvämt grepp-8 delar



BE-8975B

☼	X	☐	☐
T 9-T 10-T 15-T 20-T 25-T 27-T 30-T 40	8	6	BE-8975B

Sats med vinkelskruvmejslar för Torx®-skruv, svartoxiderad yta-8 delar



BE-8975

☼	X	☐	☐
T 9 10 15 20 25 27 30 40	8	6	BE-8975

Långa vinkelskruvmejslar med kula för Torx®-skruv, svartoxiderad yta



1996TORX

☼	L	☐	☐
T 9	80 mm	5	1996TORX-T9
T 10	86 mm	5	1996TORX-T10
T 15	90 mm	5	1996TORX-T15

☼	L	☐	☐
T 20	95 mm	5	1996TORX-T20
T 25	100 mm	5	1996TORX-T25
T 27	105 mm	5	1996TORX-T27
T 30	114 mm	5	1996TORX-T30
T 40	124 mm	5	1996TORX-T40
T 45	133 mm	5	1996TORX-T45
T 50	152 mm	5	1996TORX-T50

Sats med långa vinkelskruvmejslar med kula för Torx®-skruv, svartoxiderad yta-5 delar



1996TORX/

☼	X	☐	☐
T10, T20, T25, T30, T40	5	1	1996TORX/5T

1996TORX-T10, 1996TORX-T20, 1996TORX-T25, 1996TORX-T30, 1996TORX-T40

Sats med vinkelskruvmejslar med kula för Torx®-skruv, svartoxiderad yta-8 delar



BE-9675

☼	X	☐	☐
T9, T10, T15, T20, T25, T27, T30, T40	8	1	BE-9675

1996TORX-T10, 1996TORX-T9, 1996TORX-T15, 1996TORX-T20, 1996TORX-T25, 1996TORX-T27, 1996TORX-T30, 1996TORX-T40



Långa vinkelskruvmejslar för Torx®-skruv med centrumpets, svartoxiderad yta



1986TORX

TR 9	80 mm	5	1986TORX-T9
TR 10	86 mm	5	1986TORX-T10
TR 15	90 mm	5	1986TORX-T15
TR 20	95 mm	5	1986TORX-T20
TR 25	100 mm	5	1986TORX-T25
TR 27	105 mm	5	1986TORX-T27
TR 30	114 mm	5	1986TORX-T30
TR 40	124 mm	5	1986TORX-T40

Sats med långa vinkelskruvmejslar för Torx®-skruv med centrumpets, svartoxiderad yta-7 delar



1986TORX/

TR10, TR15, TR20, TR25, TR27, TR30, TR40	7	1	1986TORX/7T

1986TORX-T10, 1986TORX-T15, 1986TORX-T20, 1986TORX-T25, 1986TORX-T27, 1986TORX-T30, 1986TORX-T40

Sats med vinkelskruvmejslar för Torx®TR-skruv med centruntapp, svartoxiderad yta-8 delar



BE-8675

T9, T10, T15, T20, T25, T27, T30, T40	8	1	BE-8675

1986TORX-T10, 1986TORX-T9, 1986TORX-T20, 1986TORX-T15, 1986TORX-T30, 1986TORX-T40, 1986TORX-T25, 1986TORX-T27

Sats med vinkelskruvmejslar för Torx®TR-skruv med centruntapp, svartoxiderad yta och hållare med tryckknapp-8 delar



BE-8976B

T9, T10, T15, T20, T25, T27, T30, T40	8	6	BE-8976B

Långa vinkelskruvmejslar med svartoxiderad yta, för Torx Plus®-skruv



1976TORX

IP 6	75 mm	5	1976TORX-T6
IP 7	80 mm	5	1976TORX-T7
IP 8	80 mm	5	1976TORX-T8
IP 9	80 mm	5	1976TORX-T9
IP 10	86 mm	5	1976TORX-T10
IP 15	90 mm	5	1976TORX-T15
IP 20	95 mm	5	1976TORX-T20
IP 25	100 mm	5	1976TORX-T25
IP 27	105 mm	5	1976TORX-T27
IP 30	114 mm	5	1976TORX-T30
IP 40	124 mm	5	1976TORX-T40

Sats med långa vinkelskruvmejslar för Torx® plus med svartoxiderad yta-5 delar



1976TORX/

IP 10, IP 20, IP 25, IP 30, IP 40	5	1	1976TORX/5T

1976TORX-T10, 1976TORX-T20, 1976TORX-T25, 1976TORX-T40, 1976TORX-T30

Sats med långa vinkelskruvmejslar med svartoxiderad yta, för Torx® Plus-skruv-8 delar



BE-7675

IP9, IP10, IP15, IP20, IP25, IP27, IP30, IP40	8	1	BE-7675

1976TORX-T10, 1976TORX-T9, 1976TORX-T15, 1976TORX-T20, 1976TORX-T25, 1976TORX-T30, 1976TORX-T40, 1976TORX-T27

VINKELSKRUVMEJSLAR

Vinkelskruvmejsel för spårskruv



2047

Skruvstorlek	Längd (mm)	Antal	Varuslag
4.0 mm	100 mm	5	2047-0.8-4
5.5 mm	125 mm	5	2047-1-5.5
8.0 mm	150 mm	5	2047-1.2-8
10.0 mm	175 mm	1	2047-1.6-10
12.0 mm	200 mm	1	2047-2-12

Vinkelskruvmejsel för Pozidriv-skruv



2047PZ

Skruvstorlek	Längd (mm)	Antal	Varuslag
PZ1, PZ2	100 mm	5	2047PZ-1-2

MULTIVERKTYG

Cykelverktygssats med fodral



BKE850901N

Storlek	Antal	Varuslag
200 x 35 x 170 mm	10	BKE850901N

Vinkelskruvmejsel för Phillips-skruv



2047PR

Skruvstorlek	Längd (mm)	Antal	Varuslag
PH 1 & 2	100 mm	5	2047PR-1-2
PH 3 & 4	200 mm	5	2047PR-3-4





BAHCO



Tänger



KLIPPANDE TÄNGER

ERGO™ sidavbitare med tvåkomponentshandtag, retur fjäder och med svartoxiderad yta



ergo®



2101G

Cu	Fe+	Piano	L		
3.5 mm	1.8 mm	1.6 mm	125 mm	5	2101G-125
3.7 mm	2.0 mm	1.8 mm	140 mm	5	2101G-140
3.8 mm	2.5 mm	2.0 mm	160 mm	5	2101G-160
4.0 mm	2.7 mm	2.3 mm	180 mm	5	2101G-180
3.5 mm	1.8 mm	1.6 mm	125 mm	5	2101G-125IP
3.7 mm	2.0 mm	1.8 mm	140 mm	5	2101G-140IP
3.8 mm	2.5 mm	2.0 mm	160 mm	5	2101G-160IP
4.0 mm	2.7 mm	2.3 mm	180 mm	5	2101G-180IP

ERGO™ sidavbitare med tvåkomponentshandtag och svartoxiderad yta



ergo®



2101G_D

Cu	Fe+	Piano	L		
3.5 mm	1.8 mm	1.6 mm	125 mm	5	2101G-125IPD
3.7 mm	2.0 mm	1.8 mm	140 mm	5	2101G-140IPD
3.8 mm	2.5 mm	2.0 mm	160 mm	5	2101G-160IPD
4.0 mm	2.7 mm	2.3 mm	180 mm	5	2101G-180IPD

ERGO™ sidavbitare med tvåkomponentshandtag som öppnar sig själva och svartoxiderad yta för plast



ergo®



2101PG

L	
160 mm	5 2101PG-160

PLASTO

ERGO™ sidavbitare med tvåkomponentshandtag som öppnar sig själva och förnicklad och förkromad yta



ergo®



2101GC

Cu	Fe+	Piano	L		
3.5 mm	1.8 mm	1.6 mm	125 mm	5	2101GC-125IP
3.7 mm	2.0 mm	1.8 mm	140 mm	5	2101GC-140IP
3.8 mm	2.5 mm	2.0 mm	160 mm	5	2101GC-160IP
4.0 mm	2.7 mm	2.3 mm	180 mm	5	2101GC-180IP

Sidavbitare med svartoxiderad yta och handtag i enkomponentsmaterial



2101D

Cu	Fe+	Piano	L		
3.5 mm	1.8 mm	1.6 mm	125 mm	5	2101D-125
3.7 mm	2.0 mm	1.8 mm	140 mm	5	2101D-140
3.8 mm	2.5 mm	2.0 mm	160 mm	5	2101D-160
4.0 mm	2.7 mm	2.3 mm	180 mm	5	2101D-180
3.5 mm	1.8 mm	1.6 mm	125 mm	5	2101D-125IP
3.7 mm	2.0 mm	1.8 mm	140 mm	5	2101D-140IP
3.8 mm	2.5 mm	2.0 mm	160 mm	5	2101D-160IP
4.0 mm	2.7 mm	2.3 mm	180 mm	5	2101D-180IP

ERGO™ extra kraftig sidavbitare med tvåkomponentshandtag, retur fjäder och med svartoxiderad yta



ergo®



21HDG

Fe+	Piano	L		
2.3 mm	2.1 mm	140 mm	5	21HDG-140
2.7 mm	2.3 mm	160 mm	5	21HDG-160
3.3 mm	2.8 mm	180 mm	5	21HDG-180
3.3 mm	2.8 mm	200 mm	5	21HDG-200
2.3 mm	2.1 mm	140 mm	5	21HDG-140IP
2.7 mm	2.3 mm	160 mm	5	21HDG-160IP
3.3 mm	2.8 mm	180 mm	5	21HDG-180IP
3.3 mm	2.8 mm	200 mm	5	21HDG-200IP

ERGO™ 14° sidavbitare med tvåkomponentshandtag som öppnar sig själva och svartoxiderad yta



ergo



21HDG-A

Fe	Plano	L	Icon 1	Icon 2
2.2 mm	2.0 mm	140 mm	5	21HDG-140A
2.5 mm	2.3 mm	160 mm	5	21HDG-160A
2.7 mm	2.5 mm	180 mm	5	21HDG-180A
3.2 mm	3.0 mm	200 mm	5	21HDG-200A

ERGO™ extra kraftig sidavbitare med tvåkomponentshandtag som öppnar sig själva och förkromad yta



ergo



21HDGC

Fe	Plano	L	Icon 1	Icon 2
2.2 mm	2.2 mm	140 mm	5	21HDGC-140IP
2.5 mm	2.5 mm	160 mm	5	21HDGC-160IP
2.8 mm	2.8 mm	180 mm	5	21HDGC-180IP
3.2 mm	3.0 mm	200 mm	5	21HDGC-200IP

Extra kraftig sidavbitare med svartoxiderad yta och enkomponentsmaterial



21HDD

Fe	Plano	L	Icon 1	Icon 2
2.2 mm	2.2 mm	140 mm	5	21HDD-140
2.5 mm	2.5 mm	160 mm	5	21HDD-160
2.8 mm	2.8 mm	180 mm	5	21HDD-180
3.2 mm	3.0 mm	200 mm	5	21HDD-200
2.2 mm	2.2 mm	140 mm	5	21HDD-140IP
2.5 mm	2.5 mm	160 mm	5	21HDD-160IP
2.8 mm	2.8 mm	180 mm	5	21HDD-180IP
3.2 mm	3.0 mm	200 mm	5	21HDD-200IP

Kraftavbitare med tvåkomponentshandtag och svartoxiderad yta



1520G

Plano	L	Icon 1	Icon 2
3.8 mm	210 mm	5	1520 G
3.8 mm	210 mm	5	1520 G IP

Kraftavbitare med PVC-överdragna handtag och svartoxiderad yta



1520D

Plano	L	Icon 1	Icon 2
3.8 mm	205 mm	5	1520 D

ERGO™ kompakt sidavbitare med tvåkomponentshandtag och svartoxiderad yta



ergo



4130, 4131





Icon 1	L	Icon 2	Icon 3
0.3-1.5 mm	120 mm	3	4130
0.3-1.5 mm	120 mm	3	4131



Kompakt sidavbitare med ovalt huvud med orange PVC-handtag



C3140

			
0,4-2,0 mm	130 mm	10	C3140
0,4-2,0 mm	130 mm	10	C3140IP

Sidavbitare med PVC-belagda handtag och svartoxiderad yta



2100PD





			
1.8 mm	3.0 mm	150 mm	5 2100PD-150

PLASTIC

Spetsig sidavbitare med orange PVC-handtag







C3330

			
0,3-1,6 mm	115 mm	10	C3330
0,3-1,6 mm	115 mm	10	C3330IP

Sidavbitare med tvåkomponentshandtag och polerad yta







2171G

				
2.5 mm	1.6 mm	1.5 mm	150 mm	5 2171G-140
2.5 mm	1.6 mm	1.5 mm	160 mm	5 2171G-160
2.5 mm	1.6 mm	1.5 mm	185 mm	5 2171G-180

Kompakt spetsig sidavbitare med urfräst huvud och orange PVC-handtag





C3330R/C3340R

			
0,3-1,25 mm	115 mm	10	C3330R
0,4-1,6 mm	130 mm	10	C3340R
0,3-1,25 mm	115 mm	10	C3330R IP
0,4-1,6 mm	130 mm	10	C3340R IP

Sidavbitare med handtag i cellulosaacetat och förnicklad och förkromad yta för stålkabel



2666NB-2676NB

			
2.7 mm	2.0 mm	160 mm	1 2674 NB

Sidavbitare med handtag i cellulosaacetat och förnicklad och förkromad yta för pianotråd



2667B-2678B

Qu	Fe+	Piano	L	Icon 1	Icon 2
3.7 mm	2.0 mm	2.0 mm	160 mm	1	2676 B
4.0 mm	2.5 mm	2.5 mm	200 mm	1	2678 B

Icon 1	Icon 2	L	Icon 3	Icon 4
0.1-1.0 mm	Ultra-flush	110 mm	1	2646 AK
0.2-1.25 mm	Ultra-flush	112,5 mm	1	2666 FK
0.4-2.0 mm	Micro-bevel	125 mm	1	2648
0.3-1.6 mm	Ultra-flush	125 mm	1	2648 A

Sidavbitare med ovalt huvud



2646M-2649

Icon 1	Icon 2	L	Icon 3	Icon 4
0.1-0.8 mm	Flush	108 mm	1	2646 M
0.2-1.25 mm	Micro-bevel	110 mm	1	2646 R
0.2-1.25 mm	Micro-bevel	110 mm	1	2646 RK
0.1-1.0 mm	Flush	110 mm	1	2646 RA
0.3-1.6 mm	Micro-bevel	112,5 mm	1	2666
0.4-2.0 mm	Micro-bevel	125 mm	1	2649

ERGO™ 20° snedavbitare



4231

Icon 1	L	Icon 3	Icon 4
0.3-1.25 mm	119 mm	3	4231

Sidavbitare med avsmalnande huvud



2646-2648A

Icon 1	Icon 2	L	Icon 3	Icon 4
0.2-1.25 mm	Micro-bevel	110 mm	1	2646
0.2-1.25 mm	Micro-bevel	110 mm	1	2646 K
0.1-1.0 mm	Ultra-flush	110 mm	1	2646 A

ERGO™ 45° snedavbitare



4239

Icon 1	L	Icon 3	Icon 4
0.3-1.0 mm	129 mm	3	4239



Snedavbitare 45° med PVC-överdragna handtag och svartoxiderad yta



2145PD

PLASTIC

3.0 mm	1.8 mm	154 mm	5	2145PD-150

Snedavbitare 45° med långt huvud



2787F

0.2-1.0 mm	Flush	117,5 mm	1	2787 F

Snedavbitare 45° med räfflat långt huvud



2787G

0.2-0.8 mm	Flush	117,5 mm	1	2787 G

Ändavbitare med handtag av tvåkomponentsmaterial och förkromad yta



527 GC

2.0 mm 2.5 mm	160 mm 200 mm	3 3	527 GC-160 527 GC-200

Ändavbitare med PVC-överdragna handtag och svartoxiderad yta



527D

2 mm 2.5 mm	160 mm 200 mm	5 5	527 D-160 527 D-200

Ändavbitare med PVC-överdragna handtag och svart, epoxylackerad yta





2339D

2.2 mm 2.2 mm 4.5 mm 4.5 mm	220 mm 220 mm 300 mm 300 mm	3 5 5 6	2339 D 2339 DIP 2339D-300 2339D-300IP

Rabbitstång med svart, epoxylackerad yta



2339

		
2.2 mm	220 mm	5 2339-220
2.2 mm	220 mm	5 2339-220IP
2.5 mm	250 mm	5 2339-250IP
3.0 mm	280 mm	5 2339-280IP
4.5 mm	300 mm	6 2339-300IP

Kompakt ändavbitare med orange PVC-handtag





C3230

	
109 mm	10 C3230
109 mm	10 C3230IP

Hovtång med PVC-handtag och svart, epoxylackerad yta







541D

		
2.0 mm	150 mm	5 541 D-150
2.0 mm	180 mm	5 541D-180
2.5 mm	200 mm	5 541 D-200
2.5 mm	225 mm	5 541D-225
2.5 mm	250 mm	5 541 D-250

90° Sidavbitare med PVC-belagda handtag och svartoxiderad yta





2190PD

			
1.8 mm	3.0 mm	143 mm	5 2190PD-150

Kraftsidavbitare med svartoxiderad yta







1519D

		
2.5 mm	230 mm	3 1519 D
		1 1519-9

Ändavbitare med syntetiska handtag och blankpolerad yta



2656/2656A

			
0.35-0.8 mm	Micro	115 mm	1 2656



Avisoleringstång med klippfunktion och PVC-överdragna handtag för koppar- och aluminiumkablar



2233D

Ø	↓	← L →	☐	☐
10 mm	50/35 mm	160 mm	5	2233 D-160
13 mm	70/50 mm	200 mm	5	2233 D-200
16 mm	95/70 mm	240 mm	5	2233 D-240
10 mm	50/35 mm	160 mm	5	2233D-160IP
13 mm	70/50 mm	200 mm	5	2233D-200IP
16 mm	95/70 mm	240 mm	5	2233D-240IP

Kabelsax med målade epoxyhandtag för koppar- och aluminiumkablar 30 mm



2520

← L →	☐	☐
550 mm	1	2520
220 mm	1	2520-SH

Kabelsax med epoxylackerade handtag. För koppar- och aluminiumkablar



2620-80

↓	← L →	☐	☐
42 mm	800 mm	1	2620-80

Kabelsax med epoxylackerade handtag. F för koppar-, aluminium- och stålkablar



2720

↓	← L →	☐	☐
42 mm	600 mm	1	2720
	163 mm	1	2720-SH

Kabelsax med elastomerhandtag för solida material och flertrådkablar



2235-160

← L →	☐	☐
165 mm	1	2235-160

Kabelsax med PVC-handtag för koppar- och aluminiumkablar



2804-2805

↓	↓	← L →	☐	☐
16 mm	34 mm	250 mm	1	2804
22 mm	52 mm	280 mm	1	2805-280

Kabelsax med PVC-överdragna handtag för flertråd och flexibla ledare



2800N-2801N

0-10 mm	170 mm	1	2800 N
0-15 mm	230 mm	1	2801 N

Bultsax med bekväma handtag och svartoxiderad yta



4559

D	Ø Fe	Ø Plano	L	
6 mm	5 mm	4 mm	330 mm	1 4559-12
8 mm	7 mm	6 mm	430 mm	8 4559-18
10 mm	9 mm	8 mm	600 mm	6 4559-24
13 mm	10 mm	9 mm	750 mm	5 4559-30
15 mm	12 mm	11 mm	900 mm	3 4559-36
15 mm	12 mm	11 mm	1060 mm	2 4559-42

Skärhuvud för bultsax 4559



4559 JC

g	
285 g	1 4559-12A JC
600 g	1 4559-18B JC
930 g	1 4559-24B JC
1260 g	1 4559-30B JC
2180 g	1 4559-36B JC
3025 g	1 4559-42A JC

Diagonal kabelsax med svartoxiderad yta



4560-210

L	
250 mm	1 4560-210

KOMBINATIONSTÄNGER

ERGO™ kombinationstång med retur fjäder, tvåkomponentshandtag och fosfaterad yta



2628G

Plano	Fe	L	
1.8 mm	2.0 mm	160 mm	5 2628 G-160
2.0 mm	2.5 mm	180 mm	5 2628 G-180
2.5 mm	3.0 mm	200 mm	5 2628 G-200
1.8 mm	2.0 mm	160 mm	5 2628 G-160IP
2.0 mm	2.5 mm	180 mm	5 2628 G-180IP
2.5 mm	3.0 mm	200 mm	5 2628G-200IP

ERGO™ kombinationstång med retur fjäder, tvåkomponentshandtag och förkromad yta



2628GC

Plano	Fe	L	
2.0 mm	1.8 mm	160 mm	5 2628 GC-160IP
2.5 mm	2.0 mm	180 mm	5 2628 GC-180IP
3.0 mm	2.5 mm	200 mm	5 2628 GC-200IP



ERGO™ förstärkt kombinationstång med retur fjäder, tvåkomponents handtag och förkromad yta



ergo



2630GC

Plano	Fe+	L		
1.8 mm	2.0 mm	160 mm	5	2630GC-160IP
2.0 mm	2.5 mm	180 mm	5	2630GC-180IP
2.5 mm	3.0 mm	200 mm	5	2630GC-200IP

Förstärkt kombinationstång med enkomponents handtag och förkromad yta



2630DC

Fe+	Plano	L		
2.0 mm	1.8 mm	160 mm	5	2630DC-160IP
2.5 mm	2.0 mm	180 mm	5	2630DC-180IP
3.0 mm	2.5 mm	200 mm	5	2630DC-200IP

ERGO™ spetskombinationstång med retur fjäder, tvåkomponents handtag och fosfaterad yta



ergo



2629G

L	Fe+	Plano		
160 mm	2.0 mm	1.8 mm	5	2629G-160
180 mm	3.0 mm	2.5 mm	5	2629G-180
200 mm	2.5 mm	2.0 mm	5	2629G-200
160 mm	2.5 mm	2.0 mm	5	2629G-160IP
180 mm	2.0 mm	1.8 mm	5	2629G-180IP
200 mm	3.0 mm	2.5 mm	5	2629G-200IP

Kombinationstång med PVC-överdragna handtag



2640D

Cu	Fe	Fe+	L		
3.0 mm	2.7 mm	2.5 mm	160 mm	10	2640D-160
3.0 mm	2.7 mm	2.5 mm	180 mm	5	2640D-180
3.5 mm	3.0 mm	2.5 mm	200 mm	5	2640D-200

Kombinationstång med enkomponents handtag och fosfaterad yta



2628D

Fe+	Plano	L		
2.0 mm	1.8 mm	160 mm	5	2628 D-160
2.5 mm	2.0 mm	180 mm	5	2628 D-180
3.0 mm	2.5 mm	200 mm	5	2628 D-200

Kombinationstång med hög utväxling, PVC-överdragna handtag



2688D

Fe+	Fe	Cu	L		
2.5 mm	3.0 mm	3.5 mm	250 mm	3	2688D-250

Kombinationstång med tvåkomponentshandtag



2678G

Fe+	Piano	L		
1.7 mm	1.3 mm	160 mm	5	2678 G-160
2.0 mm	1.4 mm	180 mm	5	2678 G-180
2.5 mm	1.5 mm	205 mm	5	2678 G-200

Tång med 2 lägen med lackerad yta



2970 G-200

L		
200 mm	5	2970G-200

HÅLLANDE TÄNGER

ERGO™ lång spetstång med retur fjäder, tvåkomponentshandtag och fosfaterad yta



2430G

Qu	Fe	Fe+	L		
2.5 mm	1.8 mm	1.4 mm	140 mm	5	2430 G-140
3.0 mm	1.8 mm	1.6 mm	160 mm	5	2430 G-160
3.0 mm	1.8 mm	1.6 mm	200 mm	5	2430 G-200
2.5 mm	1.8 mm	1.4 mm	140 mm	5	2430 G-140 IP
3.0 mm	1.8 mm	1.6 mm	160 mm	5	2430 G-160 IP
3.0 mm	1.8 mm	1.6 mm	200 mm	5	2430 G-200 IP

ERGO™ lång spetstång med retur fjäder, tvåkomponentshandtag och förkromad yta



2430GC

Qu	Fe	Fe+	L		
2.5 mm	1.8 mm	1.4 mm	140 mm	5	2430 GC-140 IP
3.0 mm	1.8 mm	1.6 mm	160 mm	5	2430 GC-160 IP
3.0 mm	1.8 mm	1.6 mm	200 mm	5	2430 GC-200 IP

Lång spetstång med enkomponentshandtag och fosfaterad yta



2430D

Qu	Fe	Fe+	L		
2.5 mm	1.8 mm	1.4 mm	140 mm	5	2430 D-140
3.0 mm	1.8 mm	1.6 mm	160 mm	5	2430 D-160
3.0 mm	1.8 mm	1.6 mm	200 mm	5	2430 D-200
2.5 mm	1.8 mm	1.4 mm	140 mm	5	2430 D-140 IP
3.0 mm	1.8 mm	1.6 mm	160 mm	5	2430 D-160 IP
3.0 mm	1.8 mm	1.6 mm	200 mm	5	2430 D-200 IP

ERGO™ lång spetstång utan skär, med retur fjäder, tvåkomponentshandtag och fosfaterad yta



2431G

L		
125 mm	5	2431G-125
140 mm	5	2431G-140
160 mm	5	2431G-160
180 mm	5	2431G-180
125 mm	5	2431G-125IP
140 mm	5	2431G-140IP
160 mm	5	2431G-160IP
180 mm	5	2431G-180IP



ERGO™ kompakt spetstång med tvåkomponentshandtag och svartoxiderad yta



ergo



4830, 4831

135 mm	3	4830
135 mm	3	4831

Spetstång med syntetiska handtag och blankpolerad yta



2656S

132 mm	1	2656 S	

Kompakt spetstång med orange PVC-handtag



C3830/C3840

121 mm	10	C3830
144 mm	10	C3840
121 mm	10	C3830IP
144 mm	10	C3840IP

Spetstång med tvåkomponentshandtag och lackerad yta



2470G

3.0 mm	1.5 mm	1.0 mm	165 mm	5	2470 G-160
3.0 mm	1.5 mm	1.0 mm	210 mm	5	2470 G-200

Kompakt spetstång med orange PVC-handtag



C3630/C3640

130 mm	10	C3630
145 mm	10	C3640
130 mm	10	C3630IP
145 mm	10	C3640IP

Extra lång spetstång med PVC-överdragna handtag och finpolerad yta



158-N

280 mm	12	158-N

ERGO™ spetstång böckad i 45°, med returfjäder, tvåkomponentshandtag och fosfaterad yta



ergo



2427G

3.0 mm	1.8 mm	1.6 mm	160 mm	5	2427 G-160
3.0 mm	1.8 mm	1.6 mm	200 mm	5	2427 G-200
3.0 mm	1.8 mm	1.6 mm	160 mm	5	2427 G-160 IP
3.0 mm	1.8 mm	1.6 mm	200 mm	5	2427 G-200 IP

ERGO™ spetstång böckad i 45°, med returfjäder, tvåkomponentshandtag och förkromad yta



ergo



2427GC

3.0 mm	1.8 mm	1.6 mm	160 mm	5	2427 GC-160IP
3.0 mm	1.8 mm	1.6 mm	200 mm	5	2427 GC-200IP

Spetstång böckad i 45°, med enkomponentshandtag och fosfaterad yta



2427D

3.0 mm	1.8 mm	1.6 mm	160 mm	5	2427 D-160
3.0 mm	1.8 mm	1.6 mm	200 mm	5	2427 D-200

ERGO™ spetstång, 60° böjd, med tvåkomponentshandtag och svartoxiderad yta



ergo



4833

130 mm	3	4833

Kompakt spetstång med 45° böjd spets och orange PVC-handtag



C3745

141 mm	10	C3745
141 mm	10	C3745IP

Kompakt 90° böckad spetstång med orange PVC-handtag



C3790

125 mm	10	C3790
125 mm	10	C3790IP



60° bockad spetstång med syntetiska handtag och blankpolerad yta



2656R

129 mm	1	2656 R

Bockad spetstång 45° med tvåkomponentshandtag och lackerad yta



2477G-200

3.0 mm	1.5 mm	1 mm	210 mm	5	2477 G-200

35° bockad extra lång spetstång med PVC-överdragna handtag och finpolerad yta



158-NB

270 mm	12	158-NB

ERGO™ kort flackstång med retur fjäder, tvåkomponentshandtag och fosfaterad yta



ergo



2420G

125 mm	5	2420 G-125
125 mm	5	2420G-125IP

ERGO™ lång flackstång med retur fjäder, tvåkomponentshandtag och fosfaterad yta



ergo



2421G

140 mm	5	2421 G-140
160 mm	5	2421 G-160
180 mm	5	2421 G-180
140 mm	5	2421 G-140IP
160 mm	5	2421 G-160 IP
180 mm	5	2421 G-180 IP

ERGO™ lång flackstång med retur fjäder, tvåkomponentshandtag och förkromad yta



ergo



2421GC

140 mm	5	2421GC-140IP
160 mm	5	2421GC-160IP
180 mm	5	2421GC-180IP

ERGO™ lång flackstång med enkomponentshandtag och fosfaterad yta



2421D

140 mm	5 2421 D-140IP
160 mm	5 2421 D-160IP
180 mm	5 2421 D-180IP

Kompakt flackstång med orange PVC-handtag



C3430

129 mm	10 C3430
129 mm	10 C3430IP

ERGO™ kontaktstång med retur fjäder, tvåkomponentshandtag och fosfaterad yta



7835G

3.0 mm 1.8 mm 1.6 mm	160 mm	5 7835 G-160

Flackstång med syntetiska handtag och blankpolerad yta



2646MF

120 mm	1 2646 MF

ERGO™ flackstång med tvåkomponentshandtag och svartoxiderad yta



4430

135 mm	3 4430

Lång flackstång med tvåkomponentshandtag och lackerad yta



2471G

165 mm	5 2471 G-160



Flacktång med PVC-överdragna handtag och svartoxiderad yta



2979D



180 mm



5 2979 D-180

ERGO™ kompakt rundtång med tvåkomponentshandtag och svartoxiderad yta



ergo



4530



135 mm



3 4530

ERGO™ rundtång med retur fjäder, tvåkomponentshandtag och fosfaterad yta



ergo



2521G



140 mm

160 mm

140 mm

160 mm



5 2521 G-140

5 2521G-160

5 2521G-140IP

5 2521 G-160 IP

Kompakt rundtång med orange PVC-handtag



C3530



127 mm

127 mm



10 C3530

10 C3530IP

Rundtång med enkomponentshandtag och fosfaterad yta



2521D



140 mm

160 mm



5 2521D-140IP

5 2521D-160IP

Minispetstång med handtag i syntetiskt material



2646MS



120 mm



1 2646 MS

POLYGRIPTÄNGER

ERGO™ polygrip med tvåkomponentshandtag och svartoxiderad yta



ergo



8223-8226



max	L	Icons
210 mm	4	8223
250 mm	4	8224
315 mm	4	8225
400 mm	1	8226
210 mm	4	8223 IP
250 mm	4	8224 IP
315 mm	4	8225 IP

ERGO™ polygrip, tvåkomponentshandtag och förkromad yta



ergo



8224/8225C



max	L	Icons
250 mm	4	8224CIP
315 mm	4	8225CIP

ERGO™ polygrip med extra bred käft, tvåkomponentshandtag och svartoxiderad yta



ergo



8231



max	L	Icons
51 mm	225 mm	4 8231
51 mm	225 mm	4 8231 IP

Polygrip med svartoxiderad yta



7223-7225

max	L	Icons
45 mm	200 mm	4 7223
63 mm	250 mm	4 7224
70 mm	300 mm	4 7225
45 mm	200 mm	8 7223IP
63 mm	250 mm	4 7224IP
70 mm	300 mm	4 7225IP

Snabbjusterad polygrip med PVC-handtag



7223D_7225D

	L	Icons
16	200 mm	8 7223D
22	250 mm	4 7224D
25	300 mm	4 7225D
16	200 mm	8 7223D IP
22	250 mm	4 7224D IP
25	300 mm	4 7225D IP

Polygrip med tvåkomponentshandtag



6224

	L	Icons
11	250 mm	4 6224



Polygriptänger med PVC-handtag



6221D-6225D

6	125 mm	10	6221D
8	150 mm	10	6222D
10	200 mm	8	6223D
11	250 mm	5	6224D
13	300 mm	5	6225D
6	125 mm	10	6221D IP
8	150 mm	10	6222D IP
10	200 mm	8	6223D IP
11	250 mm	5	6224D IP
13	300 mm	5	6225D IP

Polygrip med tvåkomponentshandtag och svartoxiderad yta



2971G

35 mm	250 mm	5	2971G-250

Polygriptång med PVC-överdragna handtag och svartoxiderad yta



221 D-225 D

117 mm	5	221 D
150 mm	5	222 D
192 mm	5	223 D
240 mm	5	224 D
305 mm	5	225 D

Polygriptång med PVC-överdragna handtag



2650

65 mm	235 mm	1	2650
	235 mm	1	2650 B

Sats med polygriptänger - 3 st



622-3P

110 x 50 x 390 mm	3	1260 g	1	622-3P

6223D, 6224D, 6225D



Sats med polygriptänger - 3 st



7224-622XD-3P

75 x 50 x 260 mm	3	813 g	1	7224-622XD-3P

6221D, 6224D

7224



SPÄRRINGSTÄNGER

Spärringstång för invändiga spärringar, rak käft och svartoxiderad yta



2800

Spärring	Spärringstj. (mm)	Längd (mm)	Antal	Modell
8-13 mm	0.8 mm	140 mm	3	2800-140
12-25 mm	1.2 mm	150 mm	3	2800-150
19-60 mm	1.7 mm	180 mm	3	2800-180
40-100 mm	2.2 mm	225 mm	3	2800-225
85-165 mm	3.1 mm	310 mm	1	2800-300

Spärringstång för invändiga spärringar med bockade käftar 90° och svartoxiderad yta



2890

Spärring	Spärringstj. (mm)	Längd (mm)	Antal	Modell
8-15 mm	0.8 mm	125 mm	3	2890-125
12-25 mm	1.2 mm	140 mm	3	2890-140
19-60 mm	1.7 mm	180 mm	3	2890-180
40-100 mm	2.2 mm	210 mm	3	2890-210
85-165 mm	3.1 mm	300 mm	1	2890-300

Spärringstång för invändiga spärringar, rak käft och förkromad yta



2461

Spärring	Spärringstj. (mm)	Längd (mm)	Antal	Modell
8-25 mm	1.0-2.0 mm	140 mm	1	2461 C8
19-60 mm	2.0-2.5 mm	180 mm	1	2461 C19
40-100 mm	2.5-3.5 mm	255 mm	1	2461 C40

Spärringstång med bockade käftar 90° och förkromad yta



2463

Spärring	Spärringstj. (mm)	Längd (mm)	Antal	Modell
8-25 mm	1.0-2.0 mm	130 mm	1	2463 D8
19-60 mm	2.0-2.5 mm	170 mm	1	2463 D19
40-100 mm	2.5-3.5 mm	210 mm	1	2463 D40

Spärringstång för utvändiga spärringar, rak käft och svartoxiderad yta



2900

Spärring	Spärringstj. (mm)	Längd (mm)	Antal	Modell
3-10 mm	0.8 mm	140 mm	3	2900-140
10-25 mm	1.2 mm	150 mm	3	2900-150
19-60 mm	1.7 mm	180 mm	3	2900-180
40-100 mm	2.2 mm	215 mm	3	2900-215
85-165 mm	3.1 mm	300 mm	1	2900-300

Spärringstång med bockade käftar 90° och svartoxiderad yta



2990

Spärring	Spärringstj. (mm)	Längd (mm)	Antal	Modell
3-10 mm	0.8 mm	125 mm	3	2990-125
10-25 mm	1.2 mm	140 mm	3	2990-140
19-60 mm	1.7 mm	180 mm	3	2990-180
40-100 mm	2.2 mm	200 mm	3	2990-200
85-165 mm	3.1 mm	300 mm	1	2990-300



Spärringstång för utvändiga spärringar, rak käft och förkromad yta



2464

Spärring diameter	Spärring bredd	Längd (L)	Material	Yta
3-10 mm	1.0-1.5 mm	120 mm	1 2464 A3	
10-25 mm	1.5-2.0 mm	120 mm	1 2464 A10	
19-60 mm	2.0-2.5 mm	180 mm	1 2464 A19	
40-100 mm	2.5-3.0 mm	210 mm	1 2464 A40	



Spetsar för spärringstångar i 2928-serien



2928-1-4

Spärring diameter	Spärring bredd	Material	Yta
2928-160		1 2928-1	
2928-200		1 2928-2	
2928-250		1 2928-3	
2928-250		1 2928-4	

Spärringstång, för utvändiga spärringar, med bockade käftar 90° och förkromad yta



2466

Spärring diameter	Spärring bredd	Längd (L)	Material	Yta
3-10 mm	1.0-1.5 mm	130 mm	1 2466 B3	
10-25 mm	1.5-2.0 mm	130 mm	1 2466 B10	
19-60 mm	2.0-2.5 mm	165 mm	1 2466 B19	
40-100 mm	2.5-3.0 mm	190 mm	1 2466 B40	



Spärringstång för utvändiga hästskoformade spärringar förkromad yta



2460

Längd (L)	Material	Yta
175 mm	1 2460	



Spärringstång för både in- och utvändiga spärringar



2928

Spärring diameter	Spärring bredd	Längd (L)	Material	Yta
7-26 mm	3-26 mm	160 mm	1 2928-160	
10-51 mm	7-51 mm	200 mm	1 2928-200	
46-102 mm	32-102 mm	250 mm	1 2928-250	



Spärringstång för utvändiga hästskoformade spärringar med föricklad och förkromad yta samt PVC-överdragna handtag



2465D

Längd (L)	Material	Yta
200 mm	1 2465D-200	



Sats med spärringstänger för invändiga och utvändiga spärringar - 4 delar



28-29/S4

740 g	1	28-29/S4

2900-180		
2800-180		
2990-180		
2890-180		

Sats med spärringstänger med utbytbara spetsar – 3 st.



9938

1640 g	1	9938

2928-160, 2928-200, 2928-250		
------------------------------	--	--

AVISOLERINGS- OCH SKALTÄNGER

ERGO™ avisoleringsstång med retur fjäder, tvåkomponents handtag och fosfaterad yta



2223G

0.5-5 mm	165 mm	5	2223 G-150

Avisoleringsstång med enkomponents handtag och fosfaterad yta



2223D

0.5-5 mm	165 mm	5	2223 D-150

Automatisk Avisoleringsstänger



3416 B

0,02-10 mm²	34-8 AWG	10	3416 B
		10	3416 B SH



Automatisk avisoleringsstång



3416 A

0,2-6 mm ²	24-10 AWG	1 3416 A	1 3416 A SH



Automatisk avisoleringsstång inbyggd avbitare och integrerad skala



3418 A

20-10 AWG	0,5-6 mm ²	3 mm	160 mm	1 3418 A	



Roterande avisoleringsverktyg



3520 A

0,5-6 mm ²		1 3520 A 1 3520 A SH



Roterande avisoleringsverktyg. 3518 A SH: Reservblad



3518 A

4-28 mm	185 mm	1 3518 A	1 3518 A SH



Roterande avisoleringsverktyg



3520 B

4,5-40 mm	167 mm	10 3520 B	10 3520 B SH



Avisoleringskniv med dolt blad



3518 B

0,5-6 mm ²	125 mm	1 3518 B	



Avisoleringstång med handtag med halkskydd



3517 A



6-13 mm 120 mm 1 3517 A

Avisoleringsverktyg för PVC-datakablar



3717 A



115 mm 4.5-10 mm mm 28 g 1 3717 A

Avisoleringstång för koaxialkablar



3417 A

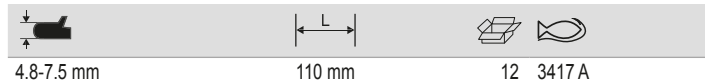

4.8-7.5 mm 110 mm 12 3417 A

Avisoleringsverktyg för datakablar



3619 A

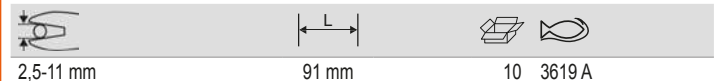

2,5-11 mm 91 mm 10 3619 A
10 3619 A SH

Precisionsavisoleringsverktyg



3719 A

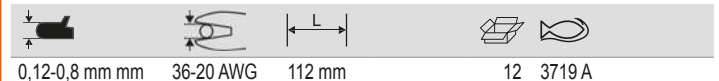

0,12-0,8 mm mm 36-20 AWG 112 mm 12 3719 A

Stansverktyg för LSA-plint



3718 A



185 mm 0,7-2,6 mm 60 g 12 3718 A



Självjusterande automatisk avisoleringstång med inbyggd avbitare



3419 B



0.25-6.00 mm



1 3419 B
1 3419 B SH

CRIMPTÄNGER

Crimping, kapning och avisoleringstång med gult handtag



CR B 01



0.50-6.00 mm² 20-10 AWG 0.75-6.00 mm² 220 mm

10 CR B 01

Crimping/kapning/avisoleringstång med rött handtag



CR B 02



0.75-6.00 mm² 1.50-6.00 mm² 14-10 AWG 220 mm

10 CR B 02

Crimping/kapning/avisoleringstång med grönt handtag



CR B 03



0.75-6.00 mm² 1.50-6.00 mm² 14-10 AWG 220 mm

5 CR B 03

Crimptång för runda kabelkontakter 0.5-2.5 mm²



CR B 05

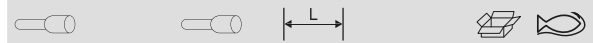

0.5-2.5 mm² 20-14 AWG 140 mm

2 CR B 05

Crimptång för runda kabelkontakter 0.5-16 mm²



CR B 06

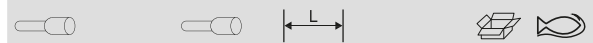

0.5-16 mm² 20-6 AWG 220 mm

2 CR B 06

Crimptång med spärrfunktion för isolerade kontakter – oval profil



CR OV 01

0.5-6.0 mm ²	20-10 AWG	256 mm	1	CR OV 01

Crimptång med spärrfunktion för kontakter med öppna stift



CR W 03

0.5-6.0 mm ²	20-10 AWG	225 mm	1	CR W 03

Crimptång med spärrfunktion för isolerade skarvar



CR W 01

0.5-6.0 mm ²	20-10 AWG	225 mm	1	CR W 01

Crimptång med spärrfunktion för skarvar av hög kvalitet



CR W 04

RG 58-59-62 mm ²	225 mm	1	CR W 04

Crimptång med spärrfunktion för isolerade skarvar



CR W 02

0.5-6.0 mm ²	20-10 AWG	225 mm	1	CR W 02

Crimptång med spärrfunktion för hylsformade kopplingsdon 0.5 AWG-4.0 AWG



CR W 05

0.5-4.0 AWG	225 mm	1	CR W 05



Crimptång med spärrfunktion för hylsformade kopplingsdon 6 AWG-16 AWG



CR W 06

6-16 AWG	225 mm	1	CR W 06		

Självjusterande crimptång – trapetsformad profil



CR SA T01

0.14-10 mm ²	180 mm	26-8 AWG	1	CR SA T01	

Självjusterande crimptång – fyrkantsprofil



CR SA S01

0.14-10 mm ²	176 mm	26-8 AWG	1	CR SA S01	

Kraftig crimptång för oisolerade skarvar, 600 mm



CR L 01

10-120 mm ²	600 mm	10-95 mm ²	1	CR L 01	

Självjusterande crimptång – sexkantprofil



CR SA H01

0.14-10 mm ²	176 mm	26-8 AWG	1	CR SA H01	
0.14-16 mm ²	176 mm	26-6 AWG	1	CR SA H16	

Kraftig crimptång för oisolerade skarvar, 360 mm



CR L 02

6-50 mm	360 mm		1	CR L 02	

Kraftig crimptång för oisolerade skarvar, 650 mm



CR L 03

25-150 mm ²	650 mm	1	CR L 03

TÅNGSATSER

ERGO™ finmekanikertångsats - 8 st



9733

30 x 215 x 215 mm	8	1	9733

4130, 4131	
4239	
4830	
4530	
4231	
4430	
4833	

Kompakt avbitar- och tångsats C3140, C3640 och C3830 - 3 st



C3901/3

3	1	C3901/3

C3140IP	
C3640IP	
C3830IP	

Kompakt avbitar- och tångsats C3330R, C3840 och C3745 - 3 st



C3902/3

3	1	C3902/3

C3330R	
C3840	
C3745	



Sats med precisionstänger och precisionsskruvmejslar, 8 delar



C3903/2-6

8	1	C3903/2-6

C3330R

C3840

700-1.5-50, 700-2-50, 700-2.5-50, 700-3-50

701-0-50, 701-1-75

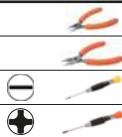

ERGO™ VVS-sats med 9031 skiftnyckel - 2 delar



ergo



9031-8224

2	693 g	3 9031-8224

9031

8224



ERGO™ Verkygssats 9072P passande för VVS-arbeten - 2 st



ergo



9873

25 x 190 x 280 mm	2	1 9873

9072 P

8224



Allroundtångsater - 3 st



ergo



9853

25 x 252 x 292 mm	3	1 9853

9071

2101G-160

8224



ERGO™ verkygssats med allroundtänger - 4 delar



ergo



9897

4	1030 g	1 9897

8224

2628 G-180

2101G-160

2430 G-160



ERGO™ verkygssats med allroundtänger - 3 delar



ergo



9897G/3

3	50 x 180 x 400 mm	788 g	1 9897G/3

BAHCO

2628 G-180



2101G-160



2430 G-200



LÅSANDE TÄNGER

Griptång med rundade käftar



2951

Öppningsbredd	Längd (L)	Antal	Varuslag
1,2 mm	140 mm	1	2951-140
2 mm	190 mm	1	2951-180
3 mm	235 mm	1	2951-250
4 mm	300 mm	1	2951-300

Griptång med rundade käftar



2953

Längd (L)	Antal	Varuslag
140 mm	1	2953-140
190 mm	1	2953-200
235 mm	1	2953-250
300 mm	1	2953-300

Griptång med raka käftar



2958

Längd (L)	Antal	Varuslag
135 mm	1	2958-140
190 mm	1	2958-200
235 mm	1	2958-250

Griptång med platta käftar och långsgående del



2968

Längd (L)	Antal	Varuslag
205 mm	1	2968-190
235 mm	1	2968-235

Griptång och svetstång med multifunktionskäftar



2957

Längd (L)	Antal	Varuslag
250 mm	1	2957-250

Griptång med långa och smala käftar



2952

Längd (L)	Antal	Varuslag
155 mm	1	2952-165
230 mm	1	2952-235



Griptänger för plåt med Nickelfinish yta



2967



180 mm



1 2967-180

Kedjeröavskärare med förkromad yta



2998



330 mm
240 mm



1 2998-SHN
1 2998-250

Griptång med parallella käftar



2955



235 mm



1 2955-250

Bordssvetstång



2960



280 mm



1 2960-280

Kedjelåstång med Nickelfinish yta



2999



500 mm
230 mm



1 2999-SHN
1 2999-250

Svetstång med C-form



2963



283 mm
458 mm
580 mm



1 2963-280
1 2963-450
1 2963-630

Självjusterande svetstång med parallell C-form



2964

Length (mm)	Quantity	Part Number
175 mm	1	2964-160
280 mm	1	2964-280
436 mm	1	2964-450
625 mm	1	2964-600

Svetstång i C-form, stegad



2962

Length (mm)	Quantity	Part Number
290 mm	1	2962-8-150
290 mm	1	2962-8-230
290 mm	1	2962-8-300

Självjusterande parallell griptång med rörliga gripskor



2950

Length (mm)	Quantity	Part Number
235 mm	1	2950-250

Svetsgriptång med U-form



2965

Length (mm)	Quantity	Part Number
228 mm	1	2965-200
290 mm	1	2965-280

Stålkämma, vridbara gripskor, smal



2956

Length (mm)	Quantity	Part Number
282 mm	1	2956-290

Specialtänger för rör och ledningar



2966

Length (mm)	Quantity	Part Number
290 mm	1	2966-280



Reservdelar för låstänger



2951-S

🔍	↔ L	g	📦	🐟
	43 mm	15 g	1	2951-S05
	46 mm	25 g	1	2951-S07
	62 mm	50 g	1	2951-S10
	87 mm	70 g	1	2951-S12

Griptång med långa käftar med 4 positioner



2997

↔ L	📦	🐟
255 mm	5	2997-300

Griptång med korta käftar med 4 positioner



2997-250

↔ L	📦	🐟
235 mm	1	2997-250

Automatiska handhållna tvingar med svartoxiderad yta



2949

↔ L	📦	🐟
193 mm	1	2949-190IP
196 mm	1	2949-200IP
240 mm	1	2949-240IP
240 mm	1	2949-250IP

Reservbult till handhållen automatisk tving



2949-L

🔍	↔ L	📦	🐟
2949-190IP	75 mm	1	2949-L075
2949-200IP, 2949-240IP	120 mm	1	2949-L120
2949-250IP	200 mm	1	2949-L200

NITVERKTYG

Handhållet nitverktyg med 360° huvud



2681

↔ L	📦	🐟
285 mm	12	2681

Nitverktyg med utbytbara huvuden



1467-250



255 mm



1 1467-250

Stanstång



2690



10 2690

Nitverktyg med långa skänklar med uppsamlare



1467-520



530 mm



1 1467-520

Förlängningsbart nitverktyg för koppar, aluminium och rostfritt stål



1467-320-850



320-850 mm



1 1467-320-850

Reservdelssats för nitverktyg 1467



1467



10 g
10 g
10 g
5 g
5 g
5 g
5 g
5 g
5 g
5 g
5 g
10 g



1 1467-LJ
1 1467-SJ
1 1467-L3,2
1 1467-S2,4
1 1467-L4
1 1467-S3,2
1 1467-L5
1 1467-S4
1 1467-L6
1 1467-S5
1 1467-L6,4
1 1467-B14

Nitverktyg med långa skänklar med uppsamlare



1467-520



530 mm



1 1467-520

Reservdelssats för nitverktyg 2681 - 4 st



2681-1



15 g



1 2681-1



SPECIALTÄNGER

Automatisk buntbandstång för buntband av nylon



790450A



2.2x5 mm



1 790450A

Buntbandstång för buntband av nylon



790455A



9.5x2.3 mm



1 790455A

Trådlåstång med svartoxiderad yta



2855



236 mm
287 mm



1 2855
1 2855 D



Trådlåstång, för enhandsbruk



2856



203 mm
268 mm



1 2856-8
1 2856-10





Rörverktyg



RÖRTÄNGER

ERGO™ rörtång med snabbjustering



ergo



1610/1620

L	max		
320 mm	1 in	1	1610
430 mm	1 1/2 in	1	1620

Justeras 10 gånger snabbare än en traditionell rörtång

ERGO™ rörtänger 90°



ergo



1410/1420

L	max		
320 mm	1 in	1	1410
430 mm	1 1/2 in	1	1420

ERGO™ 90° rörtång med mjuk greppyta



ergo



1410D/1420D

L	max		
320 mm	1 in	1	1410D
430 mm	1 1/2 in	1	1420D

Rörtänger 90°



140-147

L	max		
210 mm	3/4 in	1	140
320 mm	1 in	1	141
426 mm	1 1/2 in	1	142
557 mm	2 1/2 in	1	143
722 mm	3 1/2 in	1	144
1060 mm	5 in	1	147

Reservmutter för rörtång med snabbjustering



1610-nut/1620-nut

∅	g		
11 mm	34 g	1	1610-NUT
11.5 mm	48 g	1	1620-NUT

Rörtång 90° av svensk modell med grön pulverlack



DOW175

L	max		
310 mm	1 in	1	DOW 175-1
420 mm	1 1/2 in	1	DOW 175-11/2
560 mm	2 in	1	DOW 175-2
630 mm	3 in	1	DOW 175-3

Hörrörtång



442 B-444 B

L	max		
320 mm	1 in	1	442 B
430 mm	2 in	1	443 B
545 mm	2 1/2 in	1	444 B

Kombinationsrörtång av svensk modell



341-344

L	max		
230 mm	1/2 in	1	341
330 mm	1 in	1	342
420 mm	1 1/2 in	1	343
530 mm	2 in	1	344

Kombinationsrörtång av svensk modell med grön pulverlack



DOW177

L	max		
325 mm	1 in	1	DOW 177-1/2-1
425 mm	1 1/2 in	1	DOW 177-11/2
534 mm	2 in	1	DOW 177-2

Hörrörtång av svensk modell



DOW176

L	max		
330 mm	1 in	1	DOW 176-1
415 mm	1 1/2 in	1	DOW 176-11/2
530 mm	2 in	1	DOW 176-2

Käft, fast, för rörtänger av aluminium



8100F

	g		
380-18	90 g	1	8100F0180
380-24	180 g	1	8100F0240
380-36	226 g	1	8100F0360

Käftar för rörtång av Stillsonmodell



8060B

	g		
361-8	80 g	1	8060B0080
361-10	200 g	1	8060B0100
361-12	270 g	1	8060B0120
361-14	330 g	1	8060B0140
361-18	520 g	1	8060B0180
361-24	970 g	1	8060B0240
361-36	1630 g	1	8060B0360

Rörtänger av aluminium



380

L	max		
253 mm	1.1/2 in	1	380-10
320 mm	2 in	1	380-14
455 mm	2.1/2 in	1	380-18
607 mm	3 in	1	380-24
910 mm	4 in	1	380-36
1210 mm	6 in	1	380-48

Muttrar för rörtänger av aluminium



8100T

	g		
380-10	30 g	1	8100T0100
380-14	45 g	1	8100T0140
380-18	70 g	1	8100T0180
380-24	110 g	1	8100T0240
380-36	220 g	1	8100T0360

Mutter för rörtång av Stillsonmodell



8060T

	g		
361-8	20 g	1	8060T0080
361-10	20 g	1	8060T0100
361-14	40 g	1	8060T0140
361-18	70 g	1	8060T0180
361-24	90 g	1	8060T0240
361-36	250 g	1	8060T0360

Käftar för rörtänger av aluminium



8100B

	g		
380-14	430 g	1	8100B0140
380-24	1000 g	1	8100B0240
380-36	1810 g	1	8100B0360

Stillson rörtänger



361

L	max		
185 mm	1 in	1	361-8
230 mm	1.1/2 in	1	361-10
265 mm	1.3/4 in	1	361-12
315 mm	2 in	1	361-14
450 mm	2.1/2 in	1	361-18
535 mm	3 in	1	361-24
900 mm	4 in	4	361-36

Extra kraftig kedjerörtång



372

L			
1,1 in		1	372-1.1/2
2,1 in		1	372-2.1/2
4 in		1	372-4
6 in		1	372-6
8 in		1	372-8
12 in		1	372-12



Reservkedja till specialrörtångar



3074

L	Handtag	Kedja	Antal	Varuslag
340 mm	372-1.1/2		1	307401B
475 mm	372-2.1/2		1	307411B
560 mm	372-4		1	307421B
830 mm	372-6		1	307431B
1000 mm	372-8		1	307441
1400 mm	372-12		1	307451

Kedjerörtång med stålhandtag



370

L	Antal	Varuslag
300 mm	1	370-4

Specialrörtångar med nylonband och stålhandtag



375

L	Antal	Varuslag
300 mm	50	375-8

Teleskopisk rörtång med 4 lägen



363

L	Antal	Varuslag
280 mm	1	363-32

RÖRAVSKÄRARE

Röravskärare



401-16

Ø	Antal	Varuslag
3-16 mm	12	401-16

Röravskärare 3 mm-28 mm



401-28

Ø	Antal	Varuslag
3-28 mm	12	401-28

Röravskärare 3 mm-35 mm



402-35

Ø	Antal	Varuslag
3-35 mm	6	402-35

Röravskärare med snabbjusteringssystem



402-76

Ø	Antal	Varuslag
12-76 mm	6	402-76

Automatisk röravskärare 10-22 mm



306-

Ø	Antal	Varuslag
10 mm	1	306-10
12 mm	1	306-12
15 mm	12	306-15
22 mm	12	306-22

Kompakt röravskärare 3–16 mm



301-16

3-16 mm	72 mm	12	301-16

Röravskärare 35-75 mm



302-76

	1	302-76-95

Sats med reservskärtrissor och stift för röravskärare 301/302



302-95-SET

30 g	1	302-95-SET

Kompakt röravskärare 3-22 mm



301-22

3-28 mm	12	301-22

Röravskärare med snabbjusteringssystem, 12–76 mm



302-76N

12-76 mm	318 mm	6	302-76N

Reservskärtrissa för röravskärare i 306-serien



306-15-95

10 g	1	306-15-95

Röravskärare 8–35 mm



302-35

3-35 mm	6	302-35

Reservskärtrissa för röravskärare i 301/302- och 401/402-serien



302/402-15-95

301/302 Pipe Cutters	5 g	100	302-15-95
401/402 Pipe Cutters	5 g	1	402-15-95

Reservskärtrissa och stift för röravskärare 401/402



402-95-SET

30 g	1	402-95-SET



Röravskärare för plaströr



311-32

32 mm	6	311-32

Röravskärare för PEX-plast



412-28-PEX

28 mm	5	412-28-PEX

Skär för rörsax 412-28-PEX



412-28-PEX-95

1	35 g	30	412-28-PEX-95

Röravskärare med utväxling, för plaströr



311-42

0-42 mm	6	311-42

Röravskärare för plast flera lager



412-26-MULTI

26 mm	5	412-26-MULTI

Skär för 412-26-MULTI plaströravskärare



412-26-MULTI-95

1	10 g	150	412-26-MULTI-95

Rörsax för plast



411

26 mm	4	411-26
35 mm	4	411-35
42 mm	6	411-42
63 mm	5	411-63

Skär för röravskärare för plast



411-95

1	39 g	50	411-26-95
1	37 g	50	411-35-95
1	41 g	50	411-42-95
1	48 g	30	411-63-95

Rörbockare



1084

250 mm	6,8 10 mm	5	1084

BOCKNINGS- OCH FORMINGSVERKTYG

Rörbockarsats för standarduppgifter



1084-KIT



10,12,14,15,16,18,20 & 22 mm



1 1084-KIT

Rörbockare



500



12 mm	1	500-12
14 mm	1	500-14
15 mm	1	500-15
16 mm	1	500-16
18 mm	1	500-18
22 mm	1	500-22



Flänsverktyg med tum-skala



4480IM



45°



5/8, 3/16, 1/4, 5/16,
3/8, 7/16, 1/2, 3/4 in



1 4480IM

Flänsverktygssats med rörvskärare och dubbla flänsadapter



4480/



45 x 140 x 330 mm



1 4480/2-ZD

AVGRADNINGSVERKTYG

Flänsverktyg med metriska storlekar



4480MM



45° 4, 6, 8, 10, 12, 14,
16, 18 mm 1 4480MM



Pennavgradare i aluminium



316-1



143 mm



12 316-1

Pennavgradarpryl med plasthandtag



316-2



150 mm



12 316-2

Reservblad för pennavgradare 316-2



316-2-95



3 g



1 316-2-95

Avgradare, rund i aluminium



318-38/318-54



8-38 mm
10-54 mm



1 318-38
1 318-54

Avgradare, rund i plast



317-40



3-40 mm



12 317-40





BAHCO



Tryckluftsverktyg



MUTTERDRAGARE

3/8" liten mutterdragare med fyrkantsfäste



BP704

BAR			
6.3 bar	1500 min	1	BP704

3/8" mutterdragare med låg vikt och mekanism med dubbla hammare



BPC816

BAR			
12.000 min	6,3 bar	10	BPC816

1/2" vinklad mutterdragare med fyrkantsfäste och stor hammarmekanism



BP814A

BAR			
7000 min	6.2 bar	10	BP814A

1/2" mutterdragare med dubbla hammare, 360 Nm



BP814

BAR			
10,000 min	6.3 bar	10	BP814

1/2" mutterdragare med dubbla hammare, 620 Nm



BP815

BAR			
7,000 min	6.3 bar	1	BP815

1/2" mutterdragarsats, 13 delar



BP815K1

BAR			
7,000 min	6.3 bar	1	BP815K1

BP815

K7800M-10, K7800M-11, K7800M-12, K7800M-13, K7800M-14, K7800M-15, K7800M-17, K7800M-19, K7800M-22, K7800M-24, K7800M-21

PM5142

1/2" mutterdragarsats, 5 delar



BP815K2

BAR			
7,000 min	6.3 bar	1	BP815K2

1/2" minimutterdragare med fyrkantsfäste och dubbla hammare



BPC813

BAR			
10000 min	6,3 bar	10	BPC813

Sats med 1/2" minimutterdragare och extra korta hylsor



BPC813K1

1/2 in	65 x 162 x 215 mm	1	BPC813K1

BPC813

K7800M-13, K7800M-14, K7800M-16, K7800M-17, K7800M-19, K7800M-21, K7800M-22, K7800M-24

1/2" mutterdragare i kompositmaterial och mekanism med dubbla hammare, 338 Nm



BPC814

BAR

12000 min 6,3 bar 10 BPC814

1/2" mutterdragare i kompositmaterial med mekanism med dubbla hammare, 786 Nm



BPC815

BAR

8000 min 6,3 bar 1 BPC815

Sats med 1/2" mutterdragare och 11 hylsor i metrisk dimensioner



BPC815K1

1/2 in 90 x 230 x 390 mm 1 BPC815K1

- BPC815**
- K7801M-10, K7801M-11, K7801M-12, K7801M-13, K7801M-14, K7801M-15, K7801M-17, K7801M-19, K7801M-21, K7801M-22, K7801M-24

Sats med 1/2" mutterdragare och 5 hylsor i metrisk dimensioner



BPC815K2

1/2 in 90 x 230 x 320 mm 1 BPC815K2

- BPC815**
- K7801M-19, K7801M-22, K7801M-24, K7801M-17, K7801M-13

Sats med 1/2" mutterdragare och 5 st hylsor i tum-dimensioner



BPC815K3

1/2 in 90 x 230 x 320 mm 1 BPC815K3

- BPC815**
- K7801Z-1/2, K7801Z-5/8, K7801Z-3/4, K7801Z-7/8, K7801Z-15/16

Sats med 1/2" mutterdragare och 5 st hjulhylsor i metrisk dimensioner



BPC815K4

1/2 in 90 x 230 x 320 mm 1 BPC815K4

- BPC815**
- BWSS12P5**

Sats med 1/2" mutterdragare och 2 st hjulhylsor i metrisk dimensioner



BPC815K6

1/2 in 90 x 230 x 320 mm 1 BPC815K6

- BPC815**
- BWSS12P319, BWSS12P317**

3/4" mutterdragare med dubbla hammare, 950 Nm



BP817

BAR

4,500 min 6,3 bar 1 BP817

3/4" mutterdragare med låg vikt, fyrkantig faste och mekanism med dubbla hammare



BPC817

BAR

5000 min 6,2 bar 4 BPC817



Sats med 3/4" mutterdragare och 4 hylsor i metrisk dimensioner



BPC817K1

3/4 in	105 x 295 x 390 mm	1	BPC817K1

BPC817	
K8901M-24, K8901M-27, K8901M-32, K8901M-30	

Sats med 3/4" mutterdragare och 4 hylsor i tum-dimensioner



BPC817K2

3/4 in	105 x 295 x 390 mm	1	BPC817K2

BPC817	
K8901Z-15/16, K8901Z-1, K8901Z-1.1/16, K8901Z-1.1/8	

1" mutterdragare med låg vikt, fyrkantsfäste och kraftig gungningsmekanism



BP901

3800 min ⁻¹	6.2 bar	1	BP901

1" mutterdragare med låg vikt, fyrkantsfäste och kraftig gungningsmekanism och 9" fyrkantsfäste



BP901L

3800 min ⁻¹	6.2 bar	1	BP901L

1" mutterdragare med låg vikt, fyrkantsfäste och kraftig mekanism med dubbla hammare



BP905P

6000 min ⁻¹	6.2 bar	2	BP905P

1" mutterdragare med låg vikt, dubbla hammare och kort axel



BP905S

6000 min ⁻¹	6.2 bar	2	BP905S

1" mutterdragare med låg vikt, fyrkantsfäste, dubbla hammare och långt fyrkantsfäste



BP905L

6000 min ⁻¹	6.2 bar	2	BP905L

Gummihylsa för mutterdragare



BPM91B

85 x 80 x 180 mm	162 g	1	BPM91BBOOT

Ljuddämparsats



BPM91MK

30 x 25 x 25 mm	5 g	1	BPM91MK1
30 x 25 x 50 mm	10 g	1	BPM91MK2

SPÄRRHANDTAG

1/4" minispärrhandtag med hastighetsreglage



BP700

	BAR		
300 min	6.3 bar	20	BP700

3/8" spärrhandtag med fyrkantfäste, kort modell



BP721

	BAR		
350 min	6.3 bar	1	BP721

3/8" spärrhandtag med hastighetsreglage



BP820

	BAR		
270 min	6.3 bar	1	BP820

1/2" spärrhandtag med gummigrepp



BP821

	BAR		
150 min	6.3 bar	1	BP821

1/2" reaktionsfri mutterdragare med fyrkantfäste



BPR821

	BAR		
600 min	6.3 bar	1	BPR821

Gummihylsa till 1/4" spärrhandtag



BP91B

35 x 40 x 60 mm	12 g	1	BP91BL
30 x 30 x 45 mm	6 g	1	BP91BS

FIL-, SLIP- OCH POLERMASKINER

Vinkelfilmaskin med gummigrepp



BP115

	BAR		
20,000 min	6.3 bar	1	BP115

Lågvarvig filmaskin med sextantsfäste och snabbchuck



BP117

	BAR		
2500 min	6.3 bar	1	BP117

Lågvarvig filmaskin med chuck med nyckel



BP118

	BAR		
2500 min	6.3 bar	1	BP118



Filmaskin med gummigrepp



BP822



BAR



25,000 min 6.3 bar 1 BP822

Slipstift för grovslipning, 6 mm axel-2 st i blisterpack



BP421M



53 mm 14 mm 1 BP421M

Slipstift för grovslipning 90°, konisk form, 6 mm axel-2 st i blisterpack



BP424M



57 mm 19 mm 1 BP424M

Tryckluftdriven filmaskin, 6 mm chuck, långt mothåll och gummigrepp



BP822E



BAR



25000 min 6.3 bar 10 BP822E

Slipstift för grovslipning, 6 mm axel-2 st i blisterpack



BP422M



46 mm 26 mm 1 BP422M

Slipstift för finslipning, med konisk form och rundad topp, med 3 mm axel-2 st i blisterpack



BP430M



55 mm 12 mm 1 BP430M

Slipstift för grovslipning, med konisk form och rundad topp, med 6 mm axel-2 st



BP420M



67 mm 25 mm 1 BP420M

Slipstift för grovslipning, 6 mm axel-2 st i blisterpack



BP423M



53 mm 25 mm 1 BP423M

Små slipstift för finslipning, 3 mm axel-2 st i blisterpack



BP431M



54 mm 13 mm 1 BP431M

Slipstift för finslipning 90°, 3 mm axel-2 st i blisterpack



BP432M

44 mm	15 mm	1	BP432M

Vinkelkapmaskin



BP110

	BAR		
18,000 min	6.3 bar	1	BP110

Ljuddämparslang för BP117 lågvarvlig filmaskin



BP117EH

50 x 100 x 50 mm	1 kg	1	BP117EH

Små slipstift, rund och avsmalnande form, 3 mm axel-2 st i blisterpack



BP433M

43 mm	14 mm	1	BP433M

Vinkelslipmaskin med gummigrepp och säkerhetsavtryckare



BP823

	BAR		
10,000 min	6.3 bar	1	BP823

Nålhacka med 19 nålar



BP127

	BAR		
3700 min	6.3 bar	1	BP127

Små slipstift för finslipning, cylindrisk form, 3 mm axel-2 st i blisterpack



BP434M

45 mm	13 mm	1	BP434M

4"/102 mm Vinkelkapmaskin



BP111E

	BAR		
15000 min	6.3 bar	12	BP111E

Nålhacka med pistolgrepp och 19 nålar



BP127P

	BAR		
3800 min	6.3 bar	1	BP127P



Nålsats



BP12718



BP127, BP127P 3 mm 1 BP12718

Radertrissa, lösningsmedelbaserad



BP830ESB

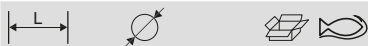

30 mm 105 mm 1 BP830ESB

Adapter för raka borst



BP830SBA



BP830K 105 mm 1 BP830SBA

Vinklade stålborstar, grov

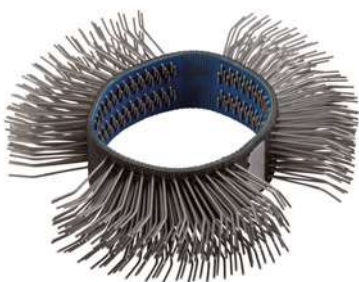

BP830CISB



BP830K 105 mm 1 BP830CISB

Radertrissa, vattenbaserad



BP830EWB



BP830K 105 mm 1 BP830EWB

Vinklade stålborstar, medium



BP830SSB



BP830K 105 mm 1 BP830SSB

Sats med tryckluftsdreven radial borstmaskin



BP830K



4000 min⁻¹ **BAR** 4 BP830K

Vinklade stålborstar, medium

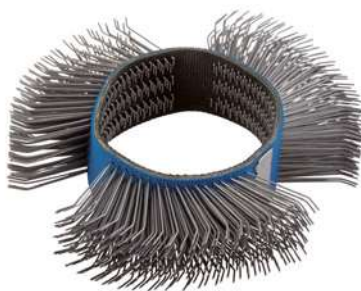

BP830MISB

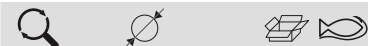

BP830K 105 mm 1 BP830MISB

Sliptrissa



BP830SW



BP830K 105 mm 1 BP830SW

Sats med rondellslipmaskin med pistolgrepp, 71 delar



BP204K

	BAR		
15000 min	6.3 bar	1	BP204K

BP20425180, BP20410800, BP20410320, BP20425220

BP204

Sliprondell för BP204 slipmaskin med pistolgrepp



BP204PAD

77 mm	-	1	BP204PAD

Bandslipmaskin med knapp för snabb bandborttagning



BP212

	BAR		
16,000 min	6.3 bar	1	BP212

Stödrondell med kardborrefäste för putsmaskin



BP51137

152 mm	x	1	BP51137

Roterande oscillerande putsmaskin med kardborrefäste, 5 mm



BP601

	BAR		
152 mm	6.3 bar	1	BP601

KARDBORREFÄSTE 53 HÅL



BP60102

BP601	152 mm	1	BP60102

3" rondellslipmaskin med pistolgrepp och gummigrepp



BP204

	BAR		
15000 min	6.3 bar	1	BP204

Sliprondell för 3" slipmaskin



BP204xyyy

77 mm	1	BP20410320
77 mm	1	BP20410800
77 mm	1	BP20425180
77 mm	1	BP20425220

20 mm bandslipmaskin med snabbknapp för bandbyte



BP222

	BAR		
16,000 min	6.3 bar	1	BP222



Roterande oscillerande slipmaskin med kardborrefäste, 2,5 mm



BP610

	BAR		
152 mm	6.3 bar	1	BP610

Polermaskin 7" med gummigrepp, vertikal



BP810

	BAR		
2500 min	6.3 bar	1	BP810

1/2" pneumatisk bormaskin, 800 varv/ minut



BPC825

	BAR		
800 min	6.3 bar	1	BPC825

Slipband till bandslipmaskin, 25-pack



BPN22201/21201

10 mm	15 g	1	BPN21201
20 mm		1	BPN22201

7" ullhätta



BP80950

178 mm	15 g	1	BP80950

3/8" kompakt tryckluftsdreven bormaskin, 2 000 varv/minut



BPC823

	BAR		
2000 min	6.3 bar	1	BPC823

BORRMASKINER OCH SKRUVDRAGARE

7" Tryckluftsdreven vinkelpolermaskin med gummigrepp och spindellås



BP809

	BAR		
2500 min	6.3 bar	1	BP809

1/2" bormaskin med gummigrepp, 13 mm



BP825

	BAR		
450 min	6.3 bar	1	BP825

3/8" kompakt vinklad tryckluftsdreven bormaskin, 1 400 varv/minut



BPA823

	BAR		
1400 min	6.3 bar	1	BPA823

Skruvdragare 1/4", 1 800 RPM



BP826

	BAR		
1800 min	6.3 bar	1	BP826

Tigersåg med säkerhetsspärr



BP824

	BAR		
10,000 min	6.3 bar	1	BP824

Släta och tandade raka blad



BPBG

15 mm	1	BPBG3515
25 mm	1	BPBG3525A
25 mm	1	BPBG3525B

Skruvdragare 1/4", 800 RPM



BP827

	BAR		
800 min	6.3 bar	1	BP827

Tigersåg med utväxling och säkerhetsavtryckare



BPG824

	BAR		
7400 min	6.3 bar	10	BPG824

Vinklat blad-2 st i blisterpack



BGBK

30 mm	1	BGBK30

SKÄRANDE VERKTYG

Kompakt tigersåg med säkerhetsavtryckare



BP828

	BAR		
10000 min	6.3 bar	1	BP828

Vindrutborttagare med låg vibrationsnivå



BP233

	BAR		
20	6.3 bar	1	BP233

Skrapblad-2 st i blisterpack



BPBSC

15 mm	1	BPBSC156



U-format blad-2 st i blisterpack



BPBU

L	
18 mm	1 BPBU18
24 mm	1 BPBU24
36 mm	1 BPBU36
60 mm	1 BPBU60
90 mm	1 BPBU90

Tryckluftdriven plåtsax med gummigrepp och säkerhetsavtryckare



BP811

min ⁻¹	BAR	
2,600 min	6.3 bar	1 BP811

Vinklat blad-2 st i blisterpack



BPBG5725/9057

L	
57 mm	1 BPBG5725
90 mm	1 BPBG9057

MEJSELHAMMARE, NITPISTOLER OCH GRAVYRPENNOR

Tryckluftshammare 3 200 slag per minut



BP910

BAR	3200	
6.3 bar	3200	5 BP910

Huggmejsel med avfasat dorn, vridbar, 10,2 mm



BP909TTP

L	
165 mm	1 BP909TTP

Huggmejsel rak, vridbar, 10,2 mm



BP909TF

L	
170 mm	1 BP909TF

Huggmejsel med vridbar klo, 10,2 mm



BP909TE

L	
139 mm	1 BP909TE

Huggmejsel bred, flat och vridbar, 10,2 mm



BP909TWF

L	
170 mm	1 BP909TWF

Huggmejsel med vridbar hammare 10,2 mm



BP909TH

L	
108 mm	1 BP909TH

Huggmejsel med rakt dorn, vridbar, 10,2 mm



BP909TSP



165 mm



1 BP909TSP

Huggmejsel rak, 10,2 mm



BP909NF



190,5 mm



1 BP909NF

Huggmejsel med fast klo, 10,2 mm



BP909NE



173 mm



1 BP909NE

Nitpistol med 880 kg dragkraft



BP277K

BAR



6.3 bar

14



8 BP277K

Nitpistol med 1 600 kg dragkraft



BP125A

BAR



6.3 bar

19



6 BP125A

Gravyrpenna med låg vibrationsnivå



BP799



13,000 min

BAR

6.3 bar



1 BP799

Spets för gravypenna, i hårdmetall



BP79912



10 g



1 BP79912

Pneumatisk fogpruta för 310 ml patron



BP215A

BAR

3.5-4.8 bar



10 BP215A

FÄRGSPRUTOR

HVLP färgspruta



BPHVLP01



0.7 kg

BAR

2-2.8 bar



1 BPHVLP01



Munstyckesats för BPHVLP01 HVLP färgspruta



BPHVLP

1.2 mm	1	BPHVLP0112
1.4 mm	1	BPHVLP0114
1.7 mm	1	BPHVLP0117
2.0 mm	1	BPHVLP0120

Blåspistol med luftanslutning i mässing och avtagbart långt säkerhetsmunstycke



BP219L

BAR		
6.3 bar	1	BP219L

Rengöringspistol med stålmunstycke



BPN010

BAR			
6.2 bar	6000-7500 min	1	BPN010

BLÅS- OCH RENGÖRINGSVERKTYG

Blåspistol med luftanslutning i mässing



BP218

BAR		
6.3 bar	1	BP218

Blåspistol med luftanslutning i mässing, 1 m extra långt munstycke



BP219XL

BAR			
6.3 bar	100 l/min	10	BP219XL

TRYCKLUFTSVERKTYG - TILLBEHÖR OCH UTRUSTNING

Magnetisk hållare för mutterdragare och momentnycklar



BP500

0.380 kg	1	BP500

Blåspistol med luftanslutning i mässing och avtagbart säkerhetsmunstycke



BP219

BAR		
6.3 bar	1	BP219

Blås- eller vakuumpistol med avtagbart säkerhetsmunstycke



BP219V

BAR		
6.3 bar	1	BP219V

1/2" Filterregulatorenhet



BP254

	BAR		
max 3800 L/min l/min	1-8.5 bar	1	BP254

1/2" Filterregulatorenhet och dimsmörjare



BP255

	BAR		
max 3,800 l/min	1-8.5 bar	1	BP255

Extra utlopp för ren och torr luft för 1/2" filterregulatorenhet och dimsmörjare med T-utlopp



BP255T-1

	BAR		
max 3800 l/min	1-8.5 bar	1	BP255T-1

Spiralluftslang med utvändig gänga 13 mm



BPH1310

1/2"-1/2" in	10 m	1	BPH1310A

1/4" dimsmörjare



BPN251

1/4" in	0.100 kg	1	BPN251

Spiralluftslang med utvändig gänga 10 mm



BPH1010

1/4"-1/4" NPT in	10 m	1	BPH1010A
1/4"-1/4" BSP in	10 m	1	BPH1010B

Adapter för hastighetskontroll för slangvinda



BPHRSC

76 x 88 x 114 mm	1 BPHRSC

1/2" Filterregulatorenhet och dimsmörjare med T-utlopp för ren och torr luft



BP255T

	BAR		
max 3800 l/min	1-8.5 bar	1	BP255T

Slangvinda med tryckluftssläng och 145° vridbart fäste och adapter för hastighetsinställning



BPHRC815/1015

8 mm	15 m	1	BPHRC815
10 mm	14+1 m	1	BPHRC1015

Slangvinda med tryckluftssläng och 145° vridbart fäste



BPHRC1020/1316

10 mm	20 m	1	BPHRC1020
13 mm	15+1 m	1	BPHRC1316



Slangvinda med tryckluftsslang och 90°
vridbart fäste



BPHRO1315



13 mm 13+2 mm 1 BPHRO1315

1/4" vridbara luftanslutningar



BPSJ



1/4" in 1 BPSJ

Invändig 1/4" snabbkoppling



BPQCF14



1/4" in 10 BPQCF14

1/4" vridbar luftanslutning med
rotationslåssystem



BPSJL



1/4" in 1 BPSJL



Sladdlösa elektriska handverktyg



MUTTERDRAGARE

12 V sladdlös mutterdragare med fyrkantfäste, 1/4"



BCL31IW1

V 12 V 1/4" 1 BCL31IW1

Sats med 12 V sladdlös slagmutterdragare med fyrkantfäste, 1/4"



BCL31IW1K1

110 x 310 x 390 mm 3.1 kg 1 BCL31IW1K1

BCL31B1x 2
BCL31C1
BCL31IW1

14,4 V 3/8" sladdlös mutterdragare med borstlös motor och fyrkantfäste



BCL32IW1

V 14,4 V 3/8" 1 BCL32IW1

Sats med 14,4 V sladdlös borstlös mutterdragare med 3/8" fyrkantfäste



BCL32IW1K1

110 x 310 x 390 mm 3.6 kg 1 BCL32IW1K1

BCL32IW1
BCL32B1x 2
BCL31C1

18 V 1/2" mutterdragarsats med sladdlös mutterdragare, fyrkantfäste



BCL33IW1K1

110 x 310 x 390 mm 5.77 kg 1 BCL33IW1K1

BCL33C1
BCL33IW1
BCL33B3x 2

18 V 1/2" sladdlös mutterdragare med borstlös motor och fyrkantfäste



BCL33IW2

V 18 V 1/2" 1 BCL33IW2

18 V 1/2" sladdlös mutterdragare med fyrkantfäste



BCL33IW1

V 18 V 1/2" 1 BCL33IW1

18 V 1/2" mutterdragarsats med sladdlös mutterdragare, fyrkantfäste och borstlös motor



BCL33IW2K1

110 x 310 x 390 mm 6.47 kg 1 BCL33IW2K1

BCL33IW2
BCL33C1
BCL33B3x 2

SPÄRRHANDTAG

12 V spärrhandtag med fyrkantfäste, 1/4"



BCL31R1

V 12 V 1/4" 1 BCL31R1

Sats med 12 V sladdöst spärrhandtag med fyrkantfäste, 1/4"



BCL31R1K1

110 x 310 x 390 mm 3.1 kg 1 BCL31R1K1

BCL31B1x 2

BCL31C1

BCL31R1

BORRMASKINER OCH SKRUVDRAGARE

18 V sladdlös och borstlös bormaskin, 1/2" (13 mm)



BCL33D1

18 V 1/2 in 1 BCL33D1

18 V sladdlös bormaskinssats, 1/2" – 13 mm



BCL33D1K1

110 x 310 x 390 mm 3.7 kg 1 BCL33D1K1

BCL33C1

BCL33D1

BCL33B1x 2

12 V sladdlös bormaskin, 3/8" – 10 mm



BCL31D1

12 V 360/1550 min 1 BCL31D1

12 V sladdlös bormaskinssats, 3/8" – 10 mm



BCL31D1K1

110 x 310 x 390 mm 3.15 kg 1 BCL31D1K1

BCL31B1x 2

BCL31C1

BCL31D1

12 V sladdlös slagskruvdragare med snabblossning och sexkantfäste, 1/4"



BCL31IS1

12 V 1/4 in 1 BCL31IS1

Sats med 12 V sladdlös slagskruvdragare med snabblossning och sexkantfäste, 1/4"



BCL31IS1K1

110 x 310 x 390 mm 3.1 kg 1 BCL31IS1K1

BCL31B1x 2

BCL31IS1

BCL31C1

12 V sladdlös skruvdragare med två hastigheter, 1/4"



BCL31SD1

12 V 1/4 in 1 BCL31SD1

Sats med 12 V sladdlös skruvdragare med två hastigheter, 1/4"



BCL31SD1K1

110 x 310 x 390 mm 2.99 kg 1 BCL31SD1K1

BCL31SD1

BCL31B1x 2

BCL31C1



FIL-, SLIP- OCH POLERMASKINER

14,4 V sladdlös slip- och putsmaskin, 2" och 3"



BCL32SP1

V			
14,4 V	1900/6900 min	1	BCL32SP1

18 V sladdlös oscillerande vinkelpolermaskin med 5" pad



BCL33AP1

V			
18 V	1100-3500 min	1	BCL33AP1

14,4 V sladdlös slip- och putsmaskin, 2" och 3"



BCL32SP1K1

	kg		
265 x 290 x 480 mm	3.29 kg	1	BCL32SP1K1

BCL32SP1	
BCL32B1x 2	
BCL31C1	

Sats med 18 V sladdlös vinkelpolermaskin med 5-tumsdyna



BCL33AP1K1

	kg		
265 x 290 x 480 mm	5.78 kg	1	BCL33AP1K1

BCL33AP1	
BCL33B3x 2	
BCL33C1	

14,4 V sladdlös slipmaskin, 6 mm fäste



BCL32DG1

V			
14,4 V	21000 min	1	BCL32DG1

Sats med 14,4 V sladdlös slipmaskin, 6 mm fäste



BCL32DG1K1

	kg		
110 x 310 x 390 mm	3.2 kg	1	BCL32DG1K1

BCL32DG1	
BCL32B1	
BCL31C1	

Sats med 14,4 V sladdlös fettspruta och behållare för 400 g smörjfett



BCL32G1K1

	kg		
265 x 290 x 480 mm	5.22 kg	1	BCL32G1K1

BCL32G1	
BCL31C1	
BCL32B1x 2	

SKÄRANDE VERKTYG

14,4 V sladdlös tigersåg



BCL32RS1

V			
14,4 V	3000 min	1	BCL32RS1

Sats med 14,4 V sladdlös tigersåg



BCL32RS1K1

	kg		
265 x 290 x 480 mm	3.5 kg	1	BCL32RS1K1

BCL32RS1



BCL32B1x 2



BCL31C1



FETTSPRUTOR

14,4 V sladdlös fettspredare med behållare för 400 g smörjfett



BCL32G1

V



14,4 V

400 g

1 BCL32G1

BATTERIER OCH LADDARE

12 V litiumjon-batteri på 2 Ah



BCL31B1

V



12 V

2 A·h

1 BCL31B1

14,4 V litiumjon-batteri på 2 Ah



BCL32B1

V



14,4 V

2 A·h

1 BCL32B1

18 V litiumjon-batteri på 2 Ah



BCL33B1

V



18 V

2 A·h

1 BCL33B1

18 V, 5 Ah litiumjon-batterier



BCL33B3

V



18 V

2 A·h

1 BCL33B3

Batteriladdare 12/14,4 V, 3 A



BCL31C1

V_{in}

V_{out}



220 V

12/14,4 V

1 BCL31C1

Batteriladdare 18 V, 2,3 A



BCL33C1

V_{in}

V_{out}



220 V

18 V

1 BCL33C1

18 V snabbbladdare, 3,4 A



BCL33C2

V_{in}

V_{out}



220 V

18 V

1 BCL33C2





BAHCO



Fordonsverktyg



MOTORVERKTYG

Inställningsverktyg för FCA GROUP 1.4
MULTIAIR motorer



BE501101



68 x 225 x 280 mm



1 BE501101

BE50110101



BE50110102



BE50110103



BE50110104



Motorinställningsverktyg för FCA Group
0.9 bensin Twinair



BE501102



68 x 225 x 280 mm



1 BE501102

BE50110202



BE50110203



Motorinställningsverktyg för FCA Group
1.6-1.9-2.0-2.4 diesel



BE501203



68 x 225 x 280 mm



1 BE501203

BE50120301



BE50120302



BE50120303



BE50120305



BE50110103



Vevaxelbalanseringsverktyg för BMW

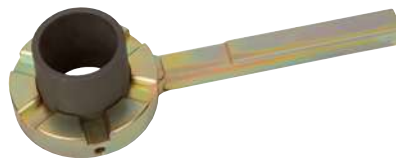

BE502104



60 x 98 x 269 mm



1726 g



8 BE502104

Vevaxelhållare för BMW



BE502106



80 x 70 x 260 mm



10 BE502106

BE50110202



BE50110203



Inställningsverktyg för FCA Group 1.3
JTD MJ



BE501204



68 x 225 x 280 mm



1 BE501204

BE50120401



BE50120402



BE50120403



BE50120404



BE50120405



Inställningsverktyg för BMW 1.8-2.0 bensin

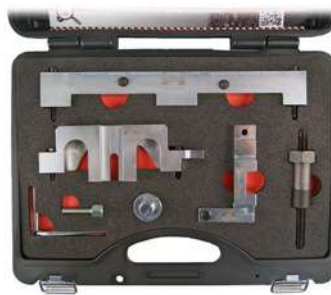

BE502101



95 x 270 x 350 mm



1 BE502101

BE50210101



BE50210102



BE50210103



BE50210104



BE50210105



BE50210106



BE50210107



Inställningsverktyg för BMW 1.6 bensin

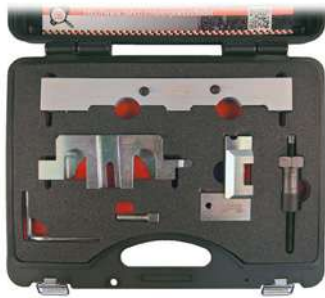

BE502102



270 x 95 x 355 mm



1 BE502102

BE50210103	
BE50210105	
BE50210107	
BE50210201	
BE50210202	
BE50210203	

Inställningsverktyg för BMW 1.6-2.0 bensin

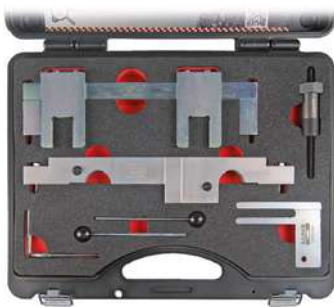

BE502103



80 x 300 x 375 mm



1 BE502103

BE50210301	
BE50210302	
BE50210303	
BE50210305	
BE50210105	
BE50210107	

Inställningsverktyg för BMW 2.0-2.5-3.0 diesel



BE502204



68 x 225 x 280 mm



1 BE502204

BE50220401	
BE50220403	
BE50220404	
BE50220405	
BE50210305	

Inställningsverktyg för BMW-mini 1.6-2.0 diesel



BE503201



68 x 225 x 280 mm



1 BE503201

BE50320101	
BE50320102	
BE50320103	
BE50320105	
BE50210305	

Inställningsverktyg för MINI-PSA 1.4-1.6 bensin



BE504102



95 x 270 x 350 mm



1 BE504102

BE50410201	
BE50410202	
BE50410203	
BE50410204	
BE50410206	
BE50210105	

Inställningsverktyg för MINI-PSA 1.6 diesel



BE504201



50 x 50 x 220 mm



1 BE504201

BE50420101	
BE50420102	
BE50420103	
BE50420104	
BE50210305	



Inställningsverktyg för Ford 1.25-1.4-1.6 bensin



BE505101

68 x 225 x 280 mm 1 BE505101

- BE50510101
- BE50510102
- BE50510103
- BE50510104
- BE50510105
- BE50510106

Inställningsverktyg för FORD 1.0 ECOBOOST bensin



BE505102

95 x 270 x 350 mm 1 BE505102

- BE50510201
- BE50510202
- BE50510203
- BE50510204
- BE50420102
- BE50510102

Inställningsverktyg för FORD 2.0-2.2-2.4 Duratorq TDCI 16v diesel



BE505203

95 x 270 x 350 mm 1 BE505203

- BE50520301
- BE50520302
- BE50520303
- BE50520304
- BE50520305
- BE50520306
- BE50520307

Inställningsverktyg för Ford 1.4-1.6-1.8-2.0-2.2-2.5 diesel



BE505204

95 x 270 x 350 mm 1 BE505204

- BE50520401
- BE50520402
- BE50520403
- BE50520404
- BE50520405
- BE50520407
- BE50520411
- BE50520412
- BE50520413
- BE50510104
- BE50420102
- BE50420103
- BE50420104
- BE50510106

Inställningsverktyg för Opel 1.0-1.2-1.4 bensin



BE506101

50 x 50 x 160 mm 1 BE506101

- BE50610101
- BE50610102
- BE50610103
- BE50610104
- BE50610105

Inställningsverktyg för Opel 1.4-1.6-1.8 bensin



BE506102

68 x 225 x 280 mm 1 BE506102

- BE50610201
- BE50610202
- BE50610203
- BE50610204
- BE50610205
- BE50610206

Inställningsverktyg för Opel 1.0-1.2-1.4 Ecoflex bensin







BE506103





95 x 270 x 350 mm 1 BE506103

- BE50610302 
- BE50610304 
- BE50610102 
- BE50610103 
- BE50610105 

Inställningsverktyg för Opel 2.0 diesel







BE506204





85 x 300 x 375 mm 1 BE506204

- BE50620401 
- BE50620402 
- BE50620403 
- BE50620404 
- BE50620405 

Inställningsverktyg för 1.0-1.1-1.4-1.6-1.8-2.0-2.2 bensin



BE507101





95 x 270 x 350 mm 1 BE507101

- BE50710103 
- BE50710104 
- BE50710105 
- BE50710106 
- BE50710107 
- BE50710108 
- BE50710109 
- BE50710110 
- BE50710111 
- BE50710112 
- BE50710101 
- BE50710102 
- BE50710113 
- BE50710114 
- BE50710116 
- BE50710117 
- BE50710118 
- BE50710119 
- BE50420104 

Inställningsverktyg för PSA 1.0-1.2 bensin



BE507102





68 x 225 x 280 mm 1 BE507102

BE50710201



BE50710202



Inställningsverktyg för PSA 1.4-1.5-1.6-1.9-2.0-2.2-2.5 diesel

























BE507203





85 x 300 x 375 mm 1 BE507203

- BE50720302 
- BE50720304 
- BE50720305 
- BE50720307 
- BE50720308 
- BE50720310 
- BE50720314 
- BE50720317 
- BE50720318 
- BE50720319 
- BE50720320 
- BE50720321 
- BE50720322 
- BE50720323 
- BE50520404 
- BE50520411 
- BE50710107 
- BE50710104 
- BE50710113 
- BE50710110 
- BE50710102 
- BE50710106 
- BE50420102
- BE50420103



Inställningsverktyg för Renault och Dacia
1.2-1.4-1.6-1.8-2.0 bensin

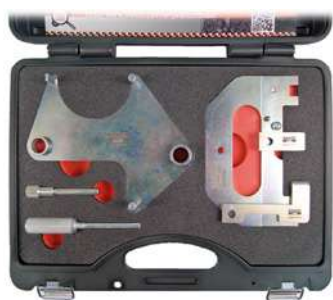

BE508101



95 x 270 x 350 mm



1 BE508101

BE50810101



BE50810103



BE50810104



BE50810106



Inställningsverktyg för Renault 1.5-1.9-2.2-
2.5 diesel



BE508202



80 x 300 x 375 mm



1 BE508202

BE50820201



BE50820202



BE50820203



BE50820204



BE50820205



BE50820206



BE50820207



BE50820208



BE50820209



BE50820211



BE50810103



BE50810104



Inställningsverktyg för Renault 2.0 diesel



BE508203



68 x 225 x 280 mm



1 BE508203

BE50820301



BE50820302



BE50820303



BE50820304



BE50210305



Inställningsverktyg för Renault och Nissan
1.6 diesel



BE508204



95 x 270 x 350 mm



1 BE508204

BE50820402



BE50820403



BE50820404



BE50820302



Inställningsverktyg för VW Group 1.4-1.6-
1.8-2.0 bensin



BE509101



80 x 300 x 375 mm



1 BE509101

BE50910101



BE50910102



BE50910103



BE50910104



BE50910105



BE50910106



BE50910107



BE50910108



BE50910109



BE50910110



BE50910111



BE50910112



BE50910114



BE50520302



Inställningsverktyg för VW Group 1.2-1.4-
1.6 bensin



BE509102



68 x 225 x 280 mm



1 BE509102

BE50910201



BE50910202



BE50910203



BE50910205



BE50910206



BE50910207



BE50520302



Inställningsverktyg för VW Group 1.2 TSI
bensin



BE509103



50 x 50 x 210 mm

1 BE509103

BE50910302



BE50910203



Inställningsverktyg för VW Group 1.0
bensin



BE509104



68 x 225 x 280 mm

1 BE509104

BE50910401



BE50910402



BE50910403



BE50910404



BE50910203



Inställningsverktyg för VW Group 1.2-1.4-
1.6-1.9-2.0 diesel



BE509205_1



60 x 60 x 220 mm

1 BE509205

BE50910103



BE50920602



BE50920603



Inställningsverktyg för VW Group 1.9-2.0
diesel



BE509206



60 x 60 x 220 mm

1 BE509206

BE50920602



BE50910103



BE50920703



Inställningsverktyg för VW Group 1.2-1.4-
1.6-1.9-2.0 diesel

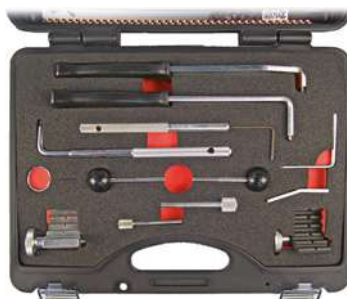

BE509207



95 x 270 x 350 mm

1 BE509207

BE50920703



BE50920707



BE50920708



BE50920709



BE50920710



BE50910103



BE50910112



BE50920602



BE50920603



BE50910109



BE50510102



Inställningsverktyg för Volvo 1.6-1.8-1.9-
2.0-2.3-2.4-2.5 bensin



BE510101



60 x 60 x 355 mm

1 BE510101

BE51010101



BE51010102



BE51010103



Inställningsverktyg för Volvo 1.6-1.8-2.0
16v bensin



BE510102



50 x 50 x 220 mm

1 BE510102

BE51010201



BE51010202



BE50510102



BE50510105



BE50510106



Inställningsverktyg för Volvo 1.6–2.0 diesel



BE510203

68 x 225 x 280 mm 1 BE510203

BE50420102	
BE50420103	
BE50420104	
BE50520407	
BE50520411	
BE50510104	

Mothållsverktyg för Volvo vevaxel



BE510304

50 x 145 x 265 mm 1 BE510304

Inställningsverktyg för Saab 1.8i bensin



BE511101

50 x 50 x 220 mm 1 BE511101

BE51110101	
BE51110102	
BE50610201	
BE50610204	

Inställningsverktyg för Saab 1.6t bensin



BE511102

50 x 50 x 207 mm 1 BE511102

BE50610201	
BE50610202	
BE50610205	
BE50610203	

Inställningsverktyg för Saab 1.9–2.0–2.2 Tid diesel



BE511203

80 x 300 x 375 mm 1 BE511203

BE51120301	
BE51120302	
BE51120303	
BE51120304	
BE51120305	
BE50120302	
BE50120303	
BE50120305	
BE50610201	

Glödsticksavdragarsats



BE513201

95 x 270 x 350 mm 2.10 kg 1 BE513201

BE51320101	
BE51320102	
BE51320103	
BE51320104	
BE51320105	
BE51320106	
BE51320107	
BE51320108	
BE51320109	
BE51320110	
BE51320111	
BE51320112	
BE51320113	
BE51320114	

Universalt mothåll för drev/kamaxel



BE523106

0.41 m 1 BE523106

Justerbart universalläsverktyg för kamaxel



BE5100



345 x 150 x 85 mm

1 BE5100

Rem-monteringsverktyg



BE230



35 x 145 x 155 mm

1 BE230

Generatorborttagarsats, 24 delar



BE500P24



55 x 270 x 370 mm

- 5 BE500P24
- 1 BE500P2401
- 1 BE500P2402
- 1 BE500P2403
- 1 BE500P2404
- 1 BE500P2405
- 1 BE500P2406
- 1 BE500P2407
- 1 BE500P2408



- 1 BE500P2409
- 1 BE500P2410
- 1 BE500P2411
- 1 BE500P2412
- 1 BE500P2413
- 1 BE500P2414
- 1 BE500P2415
- 1 BE500P2416
- 1 BE500P2417
- 1 BE500P2418
- 1 BE500P2419
- 1 BE500P2420
- 1 BE500P2421
- 1 BE500P2422
- 1 BE500P2423
- 1 BE500P2424

Sats med mätutrustning för kontroll av motorkompression på dieselmotorer



BE5401D



105 x 325 x 410 mm

1 BE5401D

Sats med mätutrustning för kontroll av motorkompression



BE5400P



70 x 160 x 260 mm

1 BE5400P

Remspänningsmätare



BE239

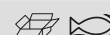

38 x 82 x 95 mm

95 mm

1 BE239

Elektronisk remspänningsmätare



BE240

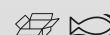

60 x 270 x 315 mm

315 mm

1 BE240

Faktabok om spänningsvärden för inställnings- och tillbehörsremmar, synkroniserade V&V samt räfflad form



BE240-CAT



710 g

1 BE240-CAT



Lasertermometer



BLT550



-50 +550 °C 40 x 95 x 145 mm 10 BLT550

UV-lampa



BLUVF



450 mm 70 x 98 x 295 mm 1 BLUVF

Verktygssats för att stoppa läckage och nypa igen slangar och rör



BE257

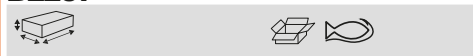

68 x 225 x 280 mm
 8 BE257
 1 BE25710
 1 BE25718
 1 BE2572
 1 BE2576

Universal injektordemonteringssats



BE512201



140 x 415 x 600 mm 1 BE512201

BE51220101	
BE51220102	
BE51220103	
BE51220104	
BE51220105	
BE51220106	
BE51220107	
BE51220108	
BE51220109	
BE51220110	
BE51220111	
BE51220112	
BE51220113	
BE51220114	
BE51220115	
BE51220116	
BE51220117	
BE51220118	
BE51220119	
BE51220120	

Sats för borttagning av insprutningsventiler



BE1311P13



80 x 355 x 445 mm 1 BE1311P13

Hylssats för spridare, 25, 27, 29, 30 mm



BE1310P4



68 x 225 x 225 mm 1 BE1310P4

1/2" krafthylsa för demontering av Bosch & Siemens spridarmunstycken



BE1310P425-BE1310P430



25 mm	1/2 in	1	BE1310P425
27 mm	1/2 in	1	BE1310P427
29 mm	1/2 in	1	BE1310P429
30 mm	1/2 in	1	BE1310P430

Rengöringssats för dieselsprutare



BE1320S17



76 x 266 x 355 mm 10 BE1320S17

En 6 mm sexkantsadapter

Rensverktyg för dieselspridare



BE1315P7



68 x 225 x 280 mm	1	BE1315P7
25 x 180 x 275 mm	1	BE1315P71
20 x 93 x 175 mm	1	BE1315P72
19 x 93 x 140 mm	1	BE1315P73
16 x 93 x 140 mm	1	BE1315P74
20 x 56 x 96 mm	1	BE1315P75
20 x 56 x 96 mm	1	BE1315P76
23 x 56 x 96 mm	1	BE1315P77

Glidhammare/avdragare för bricka och torkare



BE1300SH



235 mm	50 x 50 x 235 mm	10	BE1300SH
--------	------------------	----	----------

Avdragare för DENSO insprutningsventiler



BE1310DNS



36.4 x 24 x 24 mm	12	BE1310DNS
-------------------	----	-----------

Avdragare för ventilsäte på Denso insprutningsventil



BE1312DNS



12 BE1312DNS

Avdragare för kopparbrickor på dieselspridare



BE1300



230 mm	35 x 35 x 260 mm	1	BE1300
--------	------------------	---	--------

Ventilsipskaft



BE762



30 x 90 x 315 mm	12	BE762
------------------	----	-------

Ventilbåge för lätta fordon



BE76101

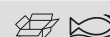

40 x 200 x 290 mm	1	BE76101
-------------------	---	---------

Sats med kopparbrickor för spridare



BE1305P450



40 x 140 x 205 mm	1	BE1305P450
-------------------	---	------------

Sats med 30 st kopparbrickor för spridare

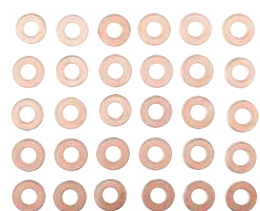

BE1305P450B



- 1 BE1305P450WS01
- 1 BE1305P450WS02
- 1 BE1305P450WS03
- 1 BE1305P450WS04
- 1 BE1305P450WS05
- 1 BE1305P450WS06
- 1 BE1305P450WS07
- 1 BE1305P450WS08
- 1 BE1305P450WS09
- 1 BE1305P450WS10
- 1 BE1305P450WS11
- 1 BE1305P450WS12
- 1 BE1305P450WS13
- 1 BE1305P450WS14
- 1 BE1305P450WS15



Sats för test av Common rail 8 insprutningsventiler



BE5350



84 x 341 x 447 mm	5	BE5350
10 x 56 x 96 mm	1	BE5350C1
10 x 56 x 96 mm	1	BE5350C2
10 x 56 x 96 mm	1	BE5350C3
10 x 56 x 96 mm	1	BE5350C4
115 x 65 x 205 mm	1	BE5350C5

Dieselin sprutningspumptestare



BE13ZL11

480 x 230 x 280 mm	4,24 kg	1 BE13ZL11

1/2" hylsa för dieselin sprutning



7807

29	80 mm
1	7807

Bitshylssats Torx® TR med centrumhål, 1/4"



BE5008

40 x 20 x 175 mm	1 BE5008

BE5008-45, BE5008-27, BE5008-25, BE5008-40, BE5008-30, BE5008-10, BE5008-20, BE5008-15

Bitshylsa Torx® TR-skrivar



BE5008-10/BE5008-45

10	1 BE5008-10
15	1 BE5008-15
20	1 BE5008-20
25	1 BE5008-25
27	1 BE5008-27
30	1 BE5008-30
40	1 BE5008-40
45	1 BE5008-45

Glöd stiftstestare



BE100

160 mm	35 x 65 x 160 mm
1	BE100

Sats med glöd stiftshylsa



BE1GP5

1/4 in	110 x 240 x 40 mm
1	BE1GP5

BE1GP514, BE1GP510, BE1GP512, BE1GP58, BE1GP59

Avdragare till glöd stift



BE1205

130 mm	35 x 35 x 130 mm
1	BE1205

Sats med 5 insatsgänger för att reparera/ återställa skadade glöd stiftsgänger



BE1210P110x

M8x1	50 g
M10x1	50 g
M10x1,25	50 g
1	BE1210P1101
1	BE1210P1102
1	BE1210P1103

Sats med rensverktyg för glödstiftshållare



BE1200P6



50 x 115 x 260 mm



1 BE1200P6

Glödstiftshylsa



BE1GP58/BE1GP514

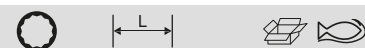

8 mm	70 mm	1	BE1GP58
9 mm	70 mm	1	BE1GP59
10 mm	70 mm	1	BE1GP510
12 mm	70 mm	1	BE1GP512
14 mm	70 mm	1	BE1GP514

Flexibel tändstiftsnyckel



BE1SP1F



30 mm



21 x 330 x 330 mm



12 BE1SP1F

Sats med rensverktyg för glödstiftshållare



BE1200P6AC1



50 x 158 x 192 mm



1 BE1200P6AC1

Sats med gängverktyg för glödstift



BE1210P11



50 x 120 x 260 mm
112 x 13 x 95 mm



1 BE1210P11
1 BE1210P9AC1

Tändstiftshylsa med magnet, 3/8"



7406ZZ



16 mm	65 mm	1	7406ZZ-16
21 mm	64 mm	1	7406ZZ-21

T-handtag för glödstiftshylsa



BE1GP5-T



1/4 in



400 mm



10 BE1GP5-T

Tändstiftstång



BE1P



290 mm



20 x 50 x 290 mm



1 BE1P

Tändstiftshylsor 1/2" fyrkantfäste



7805GPR



16 mm	64 mm	120	7805GPR-16
21 mm	64 mm	100	7805GPR-21



Tändstiftshylsor 3/8" fyrkantsfäste



7402GPR

16 mm	120	7402GPR-16
18 mm	120	7402GPR-18
21 mm	100	7402GPR-21

Tändstiftsnyckel



BE1SP

3/8 in	252 mm	10	BE1SP16L
3/8 in	252 mm	1	BE1SP14L

Tändstiftshylsa med ledat skaft och t-handtag



BE1T14/BE1T16/BE1T21

14 mm	65/310 mm	1	BE1T14
16 mm	63/450 mm	1	BE1T16
21 mm	67/450 mm	1	BE1T21

BE110014 Gängtapp: M14 x 1,25P



BE110014/BE110015

55 g	1	BE110014
55 g	1	BE110015

Insatsgंगा för att reparera tändstiftsgångor



BE1100AC1/BE1100AC2

15 mm	1	BE1100AC1
15 mm	1	BE1100AC2

Bitshylssats 1/2" för Ribe-skruv, passar för motorer



BE5102

65 x 225 x 225 mm	1	BE5102

BE51026, BE51025, BE510210, BE510211, BE510212, BE510213, BE51027, BE51028, BE51029

Bitshylsa 1/2" för Ribe-skruv



BE51025-BE510213

RM5	100 mm	1	BE51025
RM6	100 mm	1	BE51026
RM7	100 mm	1	BE51027
RM8	100 mm	1	BE51028
RM9	100 mm	1	BE51029
RM10	100 mm	1	BE510210
RM11	100 mm	1	BE510211
RM12	100 mm	1	BE510212
RM13	100 mm	1	BE510213

Bitshylssats 1/2" för XZN-skrivar, passar för motorer



BE5103

65 x 225 x 225 mm	1	BE5103

BE51036, BE51038, BE510310, BE510312, BE51035, BE510314

Bitshylsa 1/2" för XZN-skriv



BE51035-BE510314

M5	140 mm	1	BE51035
M6	140 mm	1	BE51036
M8	140 mm	1	BE51038
M10	140 mm	1	BE510310
M12	140 mm	1	BE510312
M14	140 mm	1	BE510314

Tändstiftsborste



52



150 mm

12 52

Stålbörste



782-U



285 mm

1 782-U

Batteripolsborste



2555



85 mm

1 2555

Sats med gängverktyg för tändstift



BE1100



68 x 225 x 280 mm

1.55 kg

8 BE1100

Fräs



BE110001



60 g

1 BE110001

Kolvringstång



BE74-55100/BE74-80120

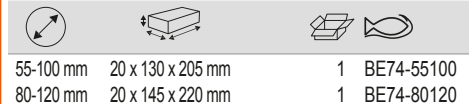

55-100 mm 20 x 130 x 205 mm

1 BE74-55100

80-120 mm 20 x 145 x 220 mm

1 BE74-80120

Kolvringkompressor



BE74-57125/BE74-90175

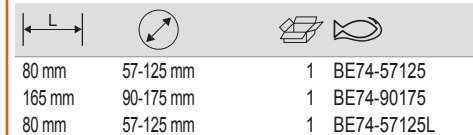

80 mm 57-125 mm

1 BE74-57125

165 mm 90-175 mm

1 BE74-90175

80 mm 57-125 mm

1 BE74-57125L

Refraktometer



3046-REF



150 mm

1 3046-REF

Mätverktyg för antifrysmedelsdensitet



BE401

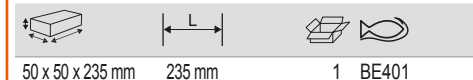

50 x 50 x 235 mm

235 mm

1 BE401



Sats för tryckprovning av kylsystem



BE400P24



127 x 435 x 510 mm

1 BE400P24

Koppling för test av kylarlock, R123/R125



BE400P243



0.06 kg

1 BE400P243

Kylarlock för test av kylsystem



BE400P2402



65 mm

1 BE400P2402

Tryckpump med skala för test av kyl- eller värmesystem



BE400P241

BAR PSI



0-2,5 bar

0-36 psi

1 BE400P241

Termometer 0-200 °C



BE400P244



0.02 kg

1 BE400P244

Kylarlock för test av kylsystem



BE400P2403



43,5 mm

1 BE400P2403

Koppling för test av kylarlock, R124/R123



BE400P242



0.035 kg

1 BE400P242

Kylarlock för test av kylsystem



BE400P2401



65 mm

1 BE400P2401

Adapter för test av kylsystem



BE400P2404



0.055 kg

1 BE400P2404

Adapter för test av kylsystem



BE400P2405



0.065 kg



1 BE400P2405

Adapter för test av kylsystem



BE400P2408



0.075 kg



1 BE400P2408

Adapter för test av kylsystem



BE400P2411



0.11 kg



1 BE400P2411

Adapter för test av kylsystem



BE400P2406



0.065 kg



1 BE400P2406

Adapter för test av kylsystem



BE400P2409



0.11 kg



1 BE400P2409

Adapter för test av kylsystem



BE400P2412



0.085 kg



1 BE400P2412

Adapter för test av kylsystem



BE400P2407



0.065 kg



1 BE400P2407

Adapter för test av kylsystem



BE400P2410



0.085 kg



1 BE400P2410

Adapter för test av kylsystem



BE400P2413



0.065 kg



1 BE400P2413



Adapter för test av kylsystem



BE400P2414



0.11 kg

1 BE400P2414

Adapter för test av kylsystem



BE400P2417



0.11 kg

1 BE400P2417

Plastnyckel för adapterkylarlock



BE400P2420



0.005 kg

1 BE400P2420

Adapter för test av kylsystem



BE400P2415



0.075 kg

1 BE400P2415

Adapter för test av kylsystem



BE400P2418



0.045 kg

1 BE400P2418

Sats för påfyllning av kylare



BE410



80 x 300 x 375 mm

4 BE410

45 x 45 x 105 mm

1 BE4101

Adapter för test av kylsystem



BE400P2416



0.065 kg

1 BE400P2416

Adapter för test av kylsystem



BE400P2419



0.075 kg

1 BE400P2419

Sats för borttagning av packningar



BE700



90 x 200 x 43 mm

1 BE700

1 BE700BP2

1 BE700SP15

10 mm bitssats



BE5032

		1 BE5032
65 x 225 x 225 mm		

BE5049M5, BE5049M6, BE5049M8, BE5049M10, BE5049M12, BE5032M14		
BE5049T20, BE5049T25, BE5049T27, BE5049T30, BE5049T40, BE5049T45, BE5049T50, BE5049T55, BE5049T60		
BE5049H5, BE5049H6, BE5049H8, BE5049H10, BE5049H12, BE5032H14		
BE5032SQ8, BE5032SQ10		
BE5049H6L, BE5049H8L, BE- 5032H10EL		
BE5049T45L, BE5032T55EL		
BE5049M8L, BE5049M10L, BE5049M12L		
BE504901		

Bits 10 mm, för Robertson-skruv



BE5032SQ

#8 mm	30 mm	1	BE5032SQ8
#10 mm	30 mm	1	BE5032SQ10

Bitshylsa 1/2" för Torx® TR-skruv med centrumspets



BE510125-BE510160

TR25	100 mm	1	BE510125
TR27	100 mm	1	BE510127

TR30	100 mm	1	BE510130
TR40	100 mm	1	BE510140
TR45	100 mm	1	BE510145
TR50	100 mm	1	BE510150
TR55	100 mm	1	BE510155
TR60	100 mm	1	BE510160

Tätningssats för vevaxel och kamaxelpackningar



BE5150P27

80 x 270 x 375 mm		
56 x 56 x 96 mm		
80 x 80 x 195 mm		
170 x 160 x 385 mm		
1	BE5150P27	
1	BE5150P271	
1	BE5150P272	
1	BE5150P273	

Verktögsset för reparation av AC



BE800P12

43 x 90 x 200 mm		
1	BE800P12	

Adaptersats för att koppla bort luftkonditionerings slangar



BAC007

240 mm		0.075 kg	1 BAC007

Motorok



BH8AC1-500

150 x 165 x 1800 mm		20.71 kg	1 BH8AC1-500

Motorställning med utväxling för 500 kg



BH8AC2-500

500 kg			1 BH8AC2-500



Slangklämstång 45°



BE250



190 mm 245 g 1 BE250

Slangklämstång med spärrfunktion, för standardklämmor



BE254A



18-53 mm 1 BE254A

Kabel

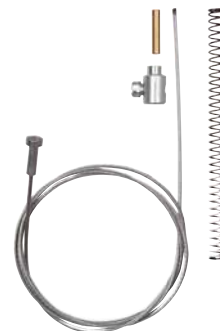

BE2542



630 mm 20 g 1 BE2542

Slangklämstång



BE251



210 mm 180 g 1 BE251

Reservkabel för tång BE254A



BE254A-01



590 mm 130 g 1 BE254A-01

Slangtång i metall



BE256M



40 x 45 x 310 mm 1 BE256M

EGR slangklämstång



BE253



870 mm 1 BE253

Reparationsats för tång BE254



BE2541



100 g 1 BE2541

Elastisk slangklämstång



BE258



12-55 mm 285 mm 1 BE258

Tång för Oetiker™-klämmor



BPOC15



275 mm



12 BPOC15

Slangtångsats



BE256P3



40 x 93 x 330 mm
15 x 55 x 155 mm
20 x 45 x 185 mm
10 x 55 x 250 mm



1 BE256P3
1 BE256-155
1 BE256-178
1 BE256-250

Sats med öppna specialhylsor



BE5500



10/11/12/14/17/19



25 BE5500

Öppna specialhylsor



BE5500-10/BE-5500-19

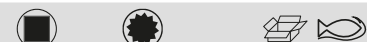

3/8	10	1	BE550010
3/8	11	1	BE550011
3/8	12	1	BE550012
3/8	14	1	BE550014
1/2	17	1	BE550017
1/2	19	1	BE550019

Tång för bränslefilterkoppling



BE6FCP



104 mm 218 mm 30 BE6FCP

Tänger för bränsleslang



BE1FLDS



8-10 mm 1 BE1FLDS

BE1FLD2, BE1FLD3, BE1FLD1

Tång för bränsleslang



BE1FLD1/BE1FLD3



10 mm 1 BE1FLD1
8 mm 1 BE1FLD2
18.5 mm 1 BE1FLD3

Bränslemätaravdragare



BE1FTW



75-160 mm 1 BE1FTW

Bränslefilternyckel för Ford 2.2TDCi



BE1FFWF



5 x 142 x 169 mm 12 BE1FFWF



Verktygssats för o-ringar



2633HD/S6



80 x 270 x 375 mm	1	2633HD/S6
42 x 93 x 290 mm	1	2633HD1
30 x 85 x 215 mm	1	2633HD2
30 x 93 x 200 mm	1	2633HD3
20 x 87 x 165 mm	1	2633HD4
10 x 60 x 120 mm	1	2633HD5
10 x 10 x 155 mm	1	2633HD6

Sats med insexskruvmejslar på t-stång
- 5 delar



BE1TH-S5



5	1	BE1TH-S5
---	---	----------

Sats med 6 st t-stångshandtag för
insexskruv i dimensionerna 2,5, 3, 4, 5,
6, 8 mm



BE1TH-S6



6	30	BE1TH-S6
---	----	----------

**BE1TH-4, BE1TH-8, BE1TH-2.5,
BE1TH-3, BE1TH-6, BE1TH-5**



T-stångshandtag för insexskruv



BE1TH

mm	g	
10 mm	385 g	5 BE1TH-10
12 mm	571 g	5 BE1TH-12
14 mm	801 g	5 BE1TH-14
2 mm	15 g	10 BE1TH-2
2,5 mm	20 g	10 BE1TH-2.5
3 mm	23 g	10 BE1TH-3
3,5 mm	23 g	10 BE1TH-3.5
4 mm	60 g	10 BE1TH-4
4,5 mm	60 g	10 BE1TH-4.5
5 mm	60 g	10 BE1TH-5
6 mm	127 g	10 BE1TH-6
7 mm	205 g	10 BE1TH-7
8 mm	205 g	10 BE1TH-8
9 mm	385 g	10 BE1TH-9

Sats med 7 st t-stångshandtag med
ledhylsor 7, 8, 10, 12, 13, 14, 17 mm.
Längd 500 mm

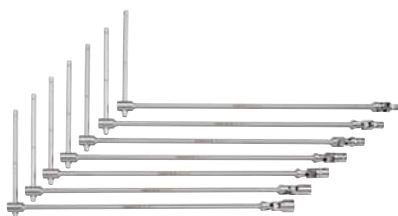

BE1TS-S7

7	1	BE1TS-S7
---	---	----------

**BE1TS-17, BE1TS-13, BE1TS-14,
BE1TS-12, BE1TS-7, BE1TS-8,
BE1TS-10**



T-stångshandtag, 500 mm långt, med
ledhylsa



BE1TS

mm	g	
10 mm	485 g	10 BE1TS-10
11 mm	485 g	10 BE1TS-11
12 mm	475 g	10 BE1TS-12
13 mm	485 g	10 BE1TS-13
14 mm	485 g	10 BE1TS-14
15 mm	485 g	10 BE1TS-15
16 mm	495 g	10 BE1TS-16
17 mm	495 g	10 BE1TS-17
18 mm	510 g	10 BE1TS-18
19 mm	495 g	10 BE1TS-19
20 mm	730 g	8 BE1TS-20
21 mm	765 g	8 BE1TS-21
22 mm	745 g	8 BE1TS-22
24 mm	745 g	8 BE1TS-24
6 mm	475 g	10 BE1TS-6
7 mm	475 g	10 BE1TS-7
8 mm	485 g	10 BE1TS-8
9 mm	475 g	10 BE1TS-9

T-handtag med roterande aluminiumhållare



1945W

	L	
1/2 in	311 mm	6 1945W12
1/4 in	311 mm	8 1945W14
3/8 in	311 mm	6 1945W38

Bitssats, 49 delar med Torx TR-bits med centrumhål



BE5049

55 x 190 x 320 mm	3.56 kg	5	BE5049



Bits 10 mm, för XZN-skruv



BE5049M

M5	30 mm	1	BE5049M5
M6	30 mm	1	BE5049M6
M8	30 mm	1	BE5049M8
M10	30 mm	1	BE5049M10
M12	30 mm	1	BE5049M12
M14	30 mm	1	BE5032M14

Adapter 1/2" för 10 mm bits



BE504901

10 mm	36 mm	1	BE504901



Bits 10 mm, för Torx-skruv



BE5049T

T20	30 mm	1	BE5049T20
T25	30 mm	1	BE5049T25
T27	30 mm	1	BE5049T27
T30	30 mm	1	BE5049T30
T40	30 mm	1	BE5049T40
T45	30 mm	1	BE5049T45
T50	30 mm	1	BE5049T50
T55	30 mm	1	BE5049T55
T60	30 mm	1	BE5049T60



Bits för insexskruv, 10 mm



BE5049H

4 mm	30 mm	1	BE5049H4
5 mm	30 mm	1	BE5049H5
6 mm	30 mm	1	BE5049H6
7 mm	30 mm	1	BE5049H7
8 mm	30 mm	1	BE5049H8
10 mm	30 mm	1	BE5049H10
12 mm	30 mm	1	BE5049H12
14 mm	30 mm	1	BE5032H14



Bits för Torx[®]-skruv med centrumsapp, 10 mm



BE5049T_H

TR20	30 mm	1	BE5049T20H
TR25	30 mm	1	BE5049T25H
TR27	30 mm	1	BE5049T27H
TR30	30 mm	1	BE5049T30H
TR40	30 mm	1	BE5049T40H



TR45	30 mm	1	BE5049T45H
TR50	30 mm	1	BE5049T50H
TR55	30 mm	1	BE5049T55H
TR60	30 mm	1	BE5049T60H

Bits*ylssats 1/2" för skruvar med Torx[®] TR-skruv med centrumspets



BE5101

65 x 225 x 225 mm	1	BE5101



BE510150, BE510145, BE510160,
BE510155, BE510127, BE510125,
BE510140, BE510130



Sats för kontroll av oljetryck



BE5200

85 x 355 x 445 mm 25 x 105 x 195 mm	1	BE5200
	1	BE530001
	1	BE52001
	1	BE52002
	1	BE52003



3/8" adapter för 10 mm bits



BE504902

10 mm	28 mm	1	BE504902

Bits för insexskruv, 10 mm



BE5049H_L

4	75 mm	1	BE5049H4L
5	75 mm	1	BE5049H5L
6	75 mm	1	BE5049H6L
7	75 mm	1	BE5049H7L
8	75 mm	1	BE5049H8L
10	75 mm	1	BE5049H10L
10	115 mm	1	BE5032H10EL
12	75 mm	1	BE5049H12L

Bits 10 mm, för XZN-skruv



BE5049M_L

M5	75 mm	1	BE5049M5L
M6	75 mm	1	BE5049M6L
M8	75 mm	1	BE5049M8L
M10	75 mm	1	BE5049M10L
M12	75 mm	1	BE5049M12L

Bitsats, 49 delar med Torx-bits av standardtyp



BE5049t

55 x 190 x 320 mm	3.54 kg	1	BE5049T

Bits för Torx[®]-skruv med centrumtapp, 10 mm



BE5049T_HL

TR20 mm	75 mm	1	BE5049T20HL
TR25 mm	75 mm	1	BE5049T25HL
TR27 mm	75 mm	1	BE5049T27HL
TR30 mm	75 mm	1	BE5049T30HL
TR40 mm	75 mm	1	BE5049T40HL
TR45 mm	75 mm	1	BE5049T45HL
TR50 mm	75 mm	1	BE5049T50HL
TR55 mm	75 mm	1	BE5049T55HL
TR60 mm	75 mm	1	BE5049T60HL
TR70 mm	100 mm	1	BE5049T70HL
TR80 mm	70 mm	1	BE5049T80HL
TR30 mm	200 mm	1	BE5049T30HXL
TR40 mm	200 mm	1	BE5049T40HXL
TR45 mm	200 mm	1	BE5049T45HXL

Bits 10 mm, för Torx-skruv



BE5049T_L

T20	75 mm	1	BE5049T20L
T25	75 mm	1	BE5049T25L
T27	75 mm	1	BE5049T27L
T30	75 mm	1	BE5049T30L

T40	75 mm	1	BE5049T40L
T45	75 mm	1	BE5049T45L
T50	75 mm	1	BE5049T50L
T55	75 mm	1	BE5049T55L
T55	115 mm	1	BE5032T55EL

AVGASSYSTEMSVERKTYG

Avgasutsug



BUCPE

5000 mm	1263 x 306 x 300 mm	1	BUCPE
105 mm	15 x 105 x 105 mm	1	BUCPEF1
121 mm	60 x 121 x 121 mm	1	BUCPEF

Slangförlängning för BUCPE



BUCPE3SH

3000 mm	63,5 mm	1	BUCPE3SH

Dubbel avgasslang för BUCPE



BUCPE3SDH

420 x 530 x 3000 mm	3000 mm	1	BUCPE3SDH

Avgasklammertång



BUC50

65 mm	305 mm	1	BUC50

OLJESERVICEVERKTYG OCH UTRUSTNING

Bränslefilternyckel



BE60F108

3/8 in	108 mm	50	BE60F108

Lambdasondstestare



BELT10

35 x 65 x 160 mm		1	BELT10

Universaltång för demontering av avgassystem



BUC110

360 mm	50 x 65 x 360 mm	1	BUC110

Avtagare för olje- och bränslefilter



BE60FW

57-120 mm	18 x 95 x 325 mm	5	BE60FW

Lambdahylsa 1/2"



7812

22 mm	78 mm	100	7812

Universalavdragare för avgassystem



BUC100

34-54 mm	320 mm	1	BUC100

Oljefilternyckel



BE611

65-105 mm	25 x 55 x 210 mm	12	BE61110
65-105 mm	1 x 12 x 382 mm	100	BE61110-1
100-155 mm	37 x 75 x 275 mm	12	BE61155
100-155 mm	1 x 12 x 529 mm	1	BE61155-1



Oljefilternyckel med gummihandtag



BE62

Ø	L	Q	P
65-105 mm	42.5 x 57 x 249 mm	10	BE62110
110-155 mm	42.5 x 85 x 314 mm	10	BE62155

Oljefilterkedjenyckel



BE64520/BE64350

L	Ø	Q	P
350 mm	60-105 mm	1	BE64350
350 mm	60-105 mm	1	BE64350CH
520 mm	60-160 mm	1	BE64520
520 mm	60-160 mm	1	BE64520CH

Universal oljefiltertång med gummirem



BE66152A

Ø	L	Q	P
150 mm	95 x 170 x 220 mm	6	BE66152A

Oljefilternyckel, 3-bent



BE65F65120

Ø	L	Q	P
3/8 in	65-120 mm	12	BE65F65120

Magnetisk oljefilternyckel, 3-bent



BE65R

Ø	L	Q	P
3/8-1/2 in	65-120 mm	1	BE65R65120
3/8-1/2 in	80-119 mm	1	BE65R80120
1/2 in	105-160 mm	1	BE65R106160

Sats med oljefilterhylsor



BE630

L	Q	P
87 x 505 x 610 mm	3	BE630

Filterkopp



BE630 Parts

Ø	Q	P
66 mm	Fiat, Renault	1 BE630666F
64 mm	Daihatsu, Fiat, Nissan, Toyota	12 BE6306514F
65-66 mm	Daihatsu, Toyota	12 BE630656714F
66 mm	Ford, Mazda, Subaru	1 BE6306814F
73 mm	Alfa Romeo, Lexus, Toyota	1 BE6307314F
74 mm	Audi, Chrysler, GM, Rover	1 BE6307415F
74-76 mm	Audi, Ford, Mercedes Benz, Opel, VW	12 BE630747615F
74-75 mm	Audi, Ford, Isuzu, Mercedes Benz, Opel, VW	1 BE630757715F
76 mm	Fiat, Mercedes Benz, Renault	12 BE6307612F
74 mm	Audi, BMW, Mercedes Benz, Opel, Porsche, VW	12 BE6307614F
74 mm	Ford	1 BE6307630F
74 mm	Fiat, Lancia	1 BE630768F
78 mm	Ford, Honda, Nissan, Toyota	12 BE6307815F
80 mm	Honda, Isuzu, Mazda, Nissan, Opel, Subaru, Toyota	1 BE6308015F
80-82 mm	Acura, Honda, Mazda, Nissan, Subaru, Toyota	1 BE630808215F
86 mm	Volvo	1 BE6308616F
86 mm	Audi, Citroen, Peugeot, Renault, VW	1 BE6308618F
89 mm	Honda, Isuzu, Mitsubishi	1 BE6309015F
92 mm	Fiat, Lancia	1 BE6309210F
92 mm	Audi, Ford, Honda, Mazda, Mitsubishi, Nissan, Opel, Porsche, Renault, Volvo, VW	1 BE6309315F
93 mm	Ford	1 BE6309336F
93 mm	Audi, VW	1 BE6309345F
95 mm	Alfa Romeo, Chrysler, Ford, Toyota	1 BE6309515F
96 mm	Audi, Renault, VW	1 BE6309618F
101 mm	Isuzu, Mitsubishi	25 BE63010015F
24 mm	BMW	50 BE630246F
106 mm	Fiat, MAN, Scania	1 BE63010615F
27 mm	Mercedes Benz	50 BE630276F
107 mm	Volvo	1 BE63010815F

32 mm	GM, Mercedes Benz, Opel, Saab	50	BE630326F
108 mm	Renault	1	BE63010818F
36 mm	BMW, Ford, Mercedes Benz, Opel, Rover, VW	100	BE630366F
38 mm	BMW, Opel, Volvo	50	BE630386F
66.5 mm	Daihatsu, Toyota	25	BE63066514F

Oljefilternyckel 27 mm för Ford och PSA Group



BE6302712F

1/2 in	27 mm	5	BE6302712F

Oljefilterhylsa Toyota, Lexus, Subaru, Daihatsu med 4 cylindrar (1,8 till 2,0L)



BE63064514F1

Toyota, Lexus, Subaru, Daihatsu 4 cylindrar (1.8-2.0l)	64,5 mm	1	BE63064514F1

Oljefilterhylsa Toyota, Lexus, Subaru, Daihatsu med 4 6 eller 8 cylindrar (2,5 L till 5,7 L)



BE63064514F2

64.5 mm	Toyota, Lexus, Subaru, Daihatsu 4, 6, 8 cylindrar (2.5 -5,7L)	1	BE63064514F2

Oljefilterhylsa 74 mm, 14 kanter



BE6307414F

#		
14	1	10

Oljefluggsnyckel, 4-kant



BE68

8 in	265 mm	12
8 in	235 mm	1
8 x 10 mm	270 mm	1

1/4" bitshylsa för montering/demontering av oljeflugg. För VAG 2 liters, 4 cylindrar motorer



BE6701VAG

10 x 50 x 125 mm	0.02 kg	1

Oljefluggsats



BE6217

55 x 105 x 220 mm	1

Oljefluggshylsor 3/8"



BE621701-BE621717

#	mm		
6	8 mm	1	BE621701
6	9 mm	1	BE621702
6	10 mm	1	BE621703
6	12 mm	1	BE621704
6	13 mm	1	BE621705
6	14 mm	1	BE621706
6	17 mm	1	BE621707
4	8 mm	1	BE621708
4	9.5 mm	1	BE621709
4	10 mm	1	BE621710
4	10.5 mm	1	BE621711
4	11 mm	1	BE621712
4	12 mm	1	BE621713
4	13.1 mm	1	BE621714
4	10 mm	1	BE621715
3	10 mm	1	BE621716
xZN	M16 mm	1	BE621717



Reparationssats för oljeplugg



BOD10P64



68 x 225 x 280 mm



1 BOD10P64

Reparationssats för oljeplugg



BOD10



34 x 93 x 105 mm
35 x 95 x 105 mm
33 x 93 x 105 mm
33 x 93 x 105 mm
33 x 93 x 105 mm
95 x 105 x 35 mm



1 BOD101
1 BOD102
1 BOD103
1 BOD104
1 BOD105
1 BOD106

Oljepluggsats



BOD10XNWS



M13x1.25
M13x1.5
M15x1.5



1 BOD101NWS
1 BOD102NWS
1 BOD103NWS



M17x1.5
M20x1.5
M22x1.5



1 BOD104NWS
1 BOD105NWS
1 BOD106NWS

Spilloljeuppsamlare med sugfunktion, 90 liter med inspektionsbehållare



BOD8903A



1700 x 419 x 608 mm



1 BOD8903A

Spilloljeuppsamlare med sugfunktion, 90 liter



BOD8902



1000 x 413 x 632 mm



38 kg



1 BOD8902

Spilloljeuppsamlare med behållare på 90 l



BOD8901



1000 x 413 x 630 mm



32 kg



1 BOD8901

Förlängningstratt för spilloljeuppsamlare



BOD8901AC1



620 x 620 x 150 mm



1 BOD8901AC1

Pump för påfyllning av växellådsolja



BOD6080P12



595 x 255 x 330 mm



1 BOD6080P12

BAHCO

Adapter för sats BOD6080P12



BOD6080P12-01

35 g	1	BOD6080P12-01

Adapter för sats BOD6080P12



BOD6080P12-05

25 g	1	BOD6080P12-05

Adapter för sats BOD6080P12



BOD6080P12-09

15 g	1	BOD6080P12-09

Adapter för sats BOD6080P12



BOD6080P12-02

55 g	1	BOD6080P12-02

Adapter för sats BOD6080P12



BOD6080P12-06

25 g	1	BOD6080P12-06

Adapter för sats BOD6080P12



BOD6080P12-10

85 g	1	BOD6080P12-10

Adapter för sats BOD6080P12



BOD6080P12-03

45 g	1	BOD6080P12-03

Adapter för sats BOD6080P12



BOD6080P12-07

45 g	1	BOD6080P12-07

Adapter för sats BOD6080P12



BOD6080P12-11

105 g	1	BOD6080P12-11

Adapter för sats BOD6080P12



BOD6080P12-04

6 g	1	BOD6080P12-04

Adapter för sats BOD6080P12



BOD6080P12-08

45 g	1	BOD6080P12-08

Oljekanna



BOD4200/BOD4500

0.2l	158 x 86 x 128 mm	1	BOD4200
0.5l	158 x 86 x 128 mm	1	BOD4500



Oljetratt



BOD301200



225 x 165 x 165 mm

1 BOD301200

För att byta ut oljepluggar med skadad gänga



BOD10XT



92 mm	M13x1.25	1	BOD101T
70 mm	M13x1.5	1	BOD102T
70 mm	M15x1.5	1	BOD103T
70 mm	M17x1.5	1	BOD104T
70 mm	M20x1.5	1	BOD105T
70 mm	M22x1.5	1	BOD106T

Fatpump



BOD60



875 x 57 x 245 mm

1 BOD60

Spillojetank



BOD2008



8 l

115 x 325 x 590 mm

1 BOD2008

Kanna med böjbar pip, 2 l



BOD2FS



2 l

330 x 130 x 380 mm

20 BOD2FS

Fettspruta



BOD5HD400



60 x 115 x 360 mm

1 BOD5HD400

Spilloljeuppsamlare



BOD1016



16 l

170 x 450 x 570 mm

1 BOD1016

Fatpump



BOD70



230 x 250 x 1330 mm

1 BOD70

Fettspruta



BOD5400/BOD5450



55 x 120 x 390 mm

1 BOD5400

65 x 125 x 385 mm

1 BOD5450

Flexibel slang



BOD54-1 / -2

4.1 mm	10.8 mm	1	BOD54-1
4.1 mm	10.8 mm	1	BOD54-2

Koppling till fettspruta



BOD54-3

37 mm	1	BOD54-3

BROMSSYSTEMSVERKTYG OCH UTRUSTNING

Bromsvätskeprovare



BBR100

20 x 20 x 150 mm	1	BBR100

Fuktmätare för bromsvätska



BBR110

35 x 65 x 160 mm	1	BBR110

Nycklar för bromsniplor



BBR501011-BBR50121314

10 / 11 mm	3/8 in	50	BBR501011
12 / 14 mm	3/8 in	50	BBR50121314

Bromsluftare



BBR350

1/4" in	300 x 125 x 125 mm	1	BBR350

12 V elektriskt bromsluftsaggregat



BBRBB12

895 x 390 x 395 mm	14.6 kg	1	BBRBB12

Sats med adaptrar för bromsluftning



BBRAS14

PN5 in	85 x 350 x 445 mm	4	BBRAS14

1 uppsättning tillbehör till hållaren



Sats med adaptrar för bromsluftning, innehåll



BBRAS14-01/BBRAS14-14

PN5 in	Universal	1	BBRAS14-01
PN5 in	Honda	1	BBRAS14-02
PN5 in	Honda Accord	1	BBRAS14-03
PN5 in	Universal	1	BBRAS14-04
PN5 in	Chrysler, Jeep, Plymouth	1	BBRAS14-05
PN5 in	Chrysler, Jeep, Plymouth, Dodge	1	BBRAS14-06
PN5 in	Nissan	1	BBRAS14-07
PN5 in	Alfa Romeo, Fiat, Peugeot, Citroën, Audi, BMW, Jaguar, Land-Rover, Mercedes, Porsche, Renault, Saab, VW, Volvo, Chrysler, Daewoo, Ford, Kia, Mazda, Mini, etc	1	BBRAS14-08
PN5 in	Hyundai, Mitsubishi, Nissan, Subaru, Chrysler, Dodge, Ford, etc.	1	BBRAS14-09
PN5 in	GM Models and Mazda	1	BBRAS14-10
PN5 in	Toyota and Lexus	1	BBRAS14-11
N/A in	Holder for universal adaptor	1	BBRAS14-12
N/A in	Syringe	1	BBRAS14-13
N/A in	Hooks, chains and roulettes for BBRAS14-01 and BBRAS14-04	1	BBRAS14-14

Mikrometer med magnetisk bas



1154

230 x 50 x 75 mm	1 1154

1154-DG

1154-MB

Indikatorclocka



1154-DG

0-10 mm	0.01 mm
1	1154-DG

Hållare med magnetisk bas



1154-MB

70 x 96 x 297 mm	230 + 150 mm
1	1154-MB

Skjutmått i aluminium



BBR400

6 x 89 x 120 mm	1 BBR400

Digitalt skjutmått för bromsskivor



BBR420

0-60 mm	35 x 104 x 176 mm
50	BBR420

Mätare av tjocklek på bromsbelägg



BBRPTG1

68 g	10 BBRPTG1

Skjutmått för att mäta diameter på bromsskiva och bromskloss



BBR410

20 x 210 x 280 mm	0.610 kg
24	BBR410

Digitalt skjutmått för bromsskivor

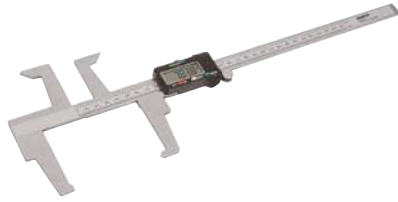

BBR405

460 mm	20	BBR405

Stålborste för rengöring av bromsskivor



783

223 mm	1	783

Tryckluftsdrevet bromskolvsvärktyg



BBR320

3/8"	1/4"	1	BBR320

Universalverktygssats för bromsok, 50 delar



BBR300P50

82 x 350 x 425 mm	5.56 kg	1	BBR300P50

Torx® 1/2" kraftbitshylssats för bromsar



BBR203P9

68 x 225 x 225 mm	1	BBR203P9

BBR203P925, BBR203P960, BBR203P930, BBR203P927, BBR203P920, BBR203P945, BBR203P955, BBR203P940, BBR203P950

1/2" kraftbitshylsa, för Torx-bits för bromsar



BBR203P920-BBR203P960

T20	78 mm	1	BBR203P920
T25	78 mm	1	BBR203P925
T27	78 mm	1	BBR203P927

T30	78 mm	1	BBR203P930
T40	78 mm	1	BBR203P940
T45	78 mm	1	BBR203P945
T50	78 mm	1	BBR203P950
T55	78 mm	1	BBR203P955
T60	78 mm	1	BBR203P960

XZN 1/2" kraftbitshylssats för bromsar



BBR201P6

68 x 225 x 225 mm	8	BBR201P6

BBR201P67814, BBR201P67816, BBR201P67818, BBR201P64018, BBR201P64014, BBR201P64016

XZN 1/2" kraftbitshylsa



BBR201P64014-BBR201P67818

M14	40 mm	1	BBR201P64014
M16	40 mm	1	BBR201P64016
M18	40 mm	1	BBR201P64018
M14	78 mm	1	BBR201P67814
M16	78 mm	1	BBR201P67816
M18	78 mm	1	BBR201P67818



1/2" femkantshylsa och bitssats för handbroms



BBR202P4

43 x 90 x 200 mm	1 BBR202P4	
	1 BBR202P410	
	1 BBR202P414	
	1 BBR202P419	
	1 BBR202P455	

Sats för att ta bort och installera bromsklossfjädrar



BBR210P3

80 x 270 x 375 mm	1 BBR210P3	
25 x 59 x 182 mm	1 BBRS210P	
75 x 270 x 350 mm	1 BBRS210P2	

Bromsfjädertänger med rörligt huvud



BBR6135

335 mm	1 BBR6135	

Bromsfjädertång



BBR6131

210 mm	1 BBR6131	

Tång för handbromskabel



BBR204

235 mm	21,9 mm	6 BBR204

Bromskretsklämmor



BBR150i

13.5 mm	10 x 52 x 165 mm	24 BBR150i

Flänsverkygssats



BBRFKM1

141 x 115 x 195 mm	1551 g	12	BBRFKM1

VÄXELLÅDE- OCH HJULVERKTYG

Fälgkors



29-B/BWXW1/BWXW2

S		
17, 19, 21 mm	1/2"	1 29-B
17, 19, 22 mm	1/2"	1 BWXW1
24, 27, 32 mm	3/4"	1 BWXW2
17, 19, 21, 22 mm	-	1 BWXW3
24, 27, 32, 38 mm	-	1 BWXW4

Sats med hjulkraftthylsor, 17, 19 och 21 mm



BWSS12P3

17, 19, 21 mm	45 x 125 x 145 mm	20 BWSS12P3

BWSS12P317, BWSS12P319, BWS-
S12P321

Sats med hjulkrafthylsor, 17, 19, 21, 22 och 24 mm



BWSS12P5

17, 19, 21, 22, 24 mm	175 x 240 x 50 mm	1	BWSS12P5

BWSS12P319, BWSS12P317, BWSS12P524, BWSS12P522, BWS- S12P321



Hjulhylsa



BWSS12P

1/2 in	17 mm	1	BWSS12P317
1/2 in	19 mm	1	BWSS12P319
1/2 in	21 mm	1	BWSS12P321
1/2 in	22 mm	1	BWSS12P522
1/2 in	24 mm	1	BWSS12P524

15 mm hjulkrafthylsa



BWSMB15

15 mm	25	BWSMB15

Hjulhylsa, 17 mm, för Mercedes låsmuttrar



BWSMB17

17 mm	1	BWSMB17

Hjulhylsa för låsmuttrar, 21 mm. För Hyundai och KIA



BWSHK21

1/2 in	21 mm	25	BWSHK21

Hjulkrafthylsasats med långa hylsor, 17, 19 och 21 mm



BWSS12P3L

17, 19, 21 mm	68 x 225 x 225 mm	1	BWSS12P3L

BWSS12P317L, BWSS12P319L, BWSS12P321L

Hjulhylsa 1/2", lång modell



BWSS12PL

1/2 in	17 mm	1	BWSS12P317L
1/2 in	19 mm	1	BWSS12P319L
1/2 in	21 mm	1	BWSS12P321L

Sats med långa skärande hylsor, 1/2". Storlek 17, 19 och 21 mm



BWTSP3L

68 x 225 x 150 mm	1	BWTSP3L

BWTSP317L, BWTSP319L, BWT- SP321L

Lång skärande hylsa, 150 mm, 1/2" fäste



BWTSP317L-BWTSP321L

1/2 in	17 mm	1	BWTSP317L
1/2 in	19 mm	1	BWTSP319L
1/2 in	21 mm	1	BWTSP321L



Sats med skärande hylsor, 1/2", storlekarna 17, 19, 21, 22, 24 mm



BWTSP6



55 x 105 x 217 mm



1 BWTSP6

BWTSP619, BWTSP617, BWTSP622, BWTSP621, BWTSP624

Skärande lång hylsa



BWTSP617-BWTSP624



17 mm	1/2 in	1 BWTSP617
19 mm	1/2 in	1 BWTSP619
21 mm	1/2 in	1 BWTSP621
22 mm	1/2 in	1 BWTSP622
24 mm	1/2 in	1 BWTSP624

Sats med skärande hylsor



BWTSP7



52 x 117 x 207 mm



1 BWTSP7

1/2": 22, 24, 27, 32 mm & 3/4": 36, 41 mm

Sats med skärande hylsor



BWTSP16



48 x 125 x 245 mm



1 BWTSP16

3/8": 8, 10, 11, 12, 13, 14, 16, 17, 18, 19 mm & 1/2": 21, 22, 24, 27 mm

Skärande hylsa



BWTSP



8 mm	3/8 in	1 BWTSP1608
10 mm	3/8 in	1 BWTSP1610
11 mm	3/8 in	1 BWTSP1611
12 mm	3/8 in	1 BWTSP1612
13 mm	3/8 in	1 BWTSP1613
14 mm	3/8 in	1 BWTSP1614
16 mm	3/8 in	1 BWTSP1616
17 mm	3/8 in	1 BWTSP1617
18 mm	3/8 in	1 BWTSP1618
19 mm	3/8 in	1 BWTSP1619
21 mm	1/2 in	1 BWTSP1621
22 mm	1/2 in	1 BWTSP1622
24 mm	1/2 in	1 BWTSP1624
27 mm	1/2 in	1 BWTSP1627
32 mm	1/2 in	1 BWTSP732
36 mm	3/4 in	1 BWTSP736
41 mm	3/4 in	1 BWTSP741

Torsionsstavsats, 5 delar, 1/2" infästning för åtdragning av hjulmuttrar med en mutterdragare utan att överskrida rekommenderat vridmoment



BWTB12P5



68 x 225 x 280 mm



1.74 kg



1 BWTB12P5

BWTB12P90, BWTB12P100, BWTB12P110, BWTB12P120, BWTB12P135

Torsionsstavsats, 1/2" infästning för åtdragning av hjulmuttrar med en mutterdragare utan att överskrida rekommenderat vridmoment



BWTB1290-BWTB12P200



Nm



200 mm	100 Nm	1 BWTB12P100
200 mm	110 Nm	1 BWTB12P110
200 mm	120 Nm	1 BWTB12P120
200 mm	135 Nm	1 BWTB12P135
200 mm	150 Nm	1 BWTB12P150
200 mm	160 Nm	1 BWTB12P160
200 mm	175 Nm	1 BWTB12P175
200 mm	190 Nm	1 BWTB12P190
200 mm	200 Nm	1 BWTB12P200
200 mm	90 Nm	1 BWTB12P90

Torsionsstav 1"



BZWTB

	MAX		
32	450 Nm	1	BZWTB0132450
32	600 Nm	1	BZWTB0132600
33	600 Nm	1	BZWTB0133600

Däcksjäm



38-8-38-24

L		
200 mm	5	38-8
300 mm	5	38-12
400 mm	5	38-16
500 mm	2	38-20
600 mm	1	38-24

Däcksjäm med specifikt böckad ände



39-24

L		
605 mm	1	39-24

Textilpåse för hjulmuttrar



BWBB

kg			
0.023 kg	180 x 1 x 300 mm	200	BWBB

Däcksjäm



38A

L		
200 mm	25	38A-08
240 mm	25	38A-10
304 mm	1	38A-12
382 mm	25	38A-15
537 mm	1	38A-21
655 mm	1	38A-26

Hjulkilar



BWC1

75 x 77 x 110 mm	25	BWC1

Gångverktygssats



BWHTRS12

	g		
225 x 67 x 225 mm	1350 g	15	BWHTRS12

En insexnyckel för åtdragning av invändigt gängsnitt

Däcksjäm för yrkesfordon och lastbilar



38C

L		
645 mm	1	38C-26

Hjulviktstång



BWP150

20 x 87 x 255 mm	1	BWP150



Digital däckmönsterdjupmätare



BWTDG1

0-25 mm 30 x 76 x 156 mm 50 BWTDG1

Luftrycksmätare



BWTPG1

20 x 90 x 394 mm 10 BWTPG1

Verktygssats för TPMS däcktrycksövervakningssystem



BWTPMSS9

68 x 225 x 225 mm 1049 g 8 BWTPMSS9

Ventilnyckel med max moment 0,45 Nm



BWTVCTT355

0.45 Nm 0.33 lb-ft 1 BWTVCTT355

Däcktömningsventil



BWTPMSS4C

27 x 59 x 108 mm 60 g 25 BWTPMSS4C

Sats med 1/2" krafthylsor och bits



BT15P5

60 x 85 x 255 mm 1 BT15P5

Krafthylsa 1/2" med tolvkantsprofil



BT15P524-BT15P536

1/2 in	24 mm	1	BT15P524
1/2 in	30 mm	1	BT15P530
1/2 in	32 mm	1	BT15P532
1/2 in	36 mm	1	BT15P536

Specialkrafthylsa 3/4", Scania, Volvo



BHVIS08

3/4 in	95 mm	1	BHVIS0895
3/4 in	100 mm	1	BHVIS08100
3/4 in	115 mm	1	BHVIS08115
	109 mm	1	BHVIS109BPW12
	120 mm	1	BHVIS120BPW16

Tunnväggig krafthylsa 1"



BHVIS12 / BHVIS06

12	68 mm	1	BHVIS1265
6	70 mm	1	BHVIS0670
6	77 mm	1	BHVIS0677
6	80 mm	1	BHVIS0680
6	85 mm	1	BHVIS0685
6	90 mm	1	BHVIS0690
6	95 mm	1	BHVIS0695
6	100 mm	1	BHVIS06100
6	105 mm	1	BHVIS06105

Krafthylsa för BPW axlar



BHVISxxBPW

3/4 in	111 mm	1	BHVIS111BPW12
3/4 in	80 mm	1	BHVIS80BPW12
3/4 in	95 mm	1	BHVIS95BPW9

Sats med hjulnavsavdragare för avdragning och glidhammare



BWHEPSH8

#4-5 / 116-135 mm	960 x 150 x 150 mm	1	BWHEPSH8

Glidhammare, 5 kg



BWSH5

100 x 100 x 985 mm	2	BWSH5

Hjulnavsavdragare med glidhammare och hydraulisk spindel



BWHEPSSH8

12 t / 265-282 mm	#4-5/116-135 mm	1	BWHEPSSH8

Platta för hjulnavsavdragare



BWHEP

#4-5 / 116-135 mm	90 x 147 x 147 mm	1	BWHEP

Glidhammare, 8 kg



BWSH8

960 x 100 x 100 mm	1	BWSH8

Hjulnavsavdragare med hydraulcylinder



BWHEPS

12	#4-5 / 116-135 mm	1	BWHEPS

Hydraulisk spindel, 12 T



BWHEHS

12 to	265-282 mm	1	BWHEHS

3,5 kilo massa



BSSHE3

60 mm	100 mm	1	BSSHE3

BWHEP	
BWHEHS	



M18-adapter



BWSH51



M38 mm M18x38 1 BWSH51

Låsbandstång



BE251200



170 mm 1 BE251200

Verktygssats för demontering av inre styrstagsleder



BS52



110 x 315 x 380 mm 3.08 kg 1 BS52

Insats för montering/demontering av inre styrstagsleder



BS5228-BS523945



28-34 mm 1 BS5228341
34-40 mm 1 BS5234401
39-35 mm 1 BS5239451

Pneumatiskt CV-damaskinstallationsverktyg



BPCVB1

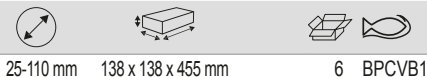

25-110 mm 138 x 138 x 455 mm 6 BPCVB1

Drivknutsverktyg



BS54



57 x 57 x 70 mm 1 BS54

Låsband och spännen av rostfritt stål



BE2512005



5 mm 12 mm 1 BE2512005

Låsband och spännen av rostfritt stål



BE2512008



8 mm 15 mm 1 BE2512008

Hylsa för demontering av styrstagsled



BS56



1/2 in 57 x 57 x 57 mm 6 BS56

Excenterhylsa för bakaxel



BS45BMW

1/2 in	40 x 43 x 43 mm	20	BS45BMW

Sats för montering och demontering av lager



BT20P26

150 x 310 x 535 mm	1	BT20P26

Kulledsavdragare med 12 tons hydraulisk spindel



BWHPJ12

12 to	70 mm	4	BWHPJ12

Verktyg för cambervinkeljustering



BS40VAG

22 mm	52 x 92 x 150 mm	20	BS40VAG

Sats för montering och demontering av lager



BT20P49

164 x 520 x 890 mm	1	BT20P49

VW T4 Kulledsverktyg



4594VWT4

245 x 112 x 320 mm	5	4594VWT4

Avdragarsats hjullager



BWB14

80 x 300 x 525 mm	2	BWB14

Kulledsavdragare



BS6

18 mm	400 mm	1	BS618
23 mm	400 mm	1	BS623

Kulledsavdragare för PSA



BS100PSA1

56 mm	52 mm	1	BS100PSA1



Verktygssats för SAC-koppling



BE301



80 x 395 x 430 mm

2 BE301

Kopplingscenteringsverktyg för SAC



BE301CM-SET



26 x 81.5 x 200 mm

50 BE301CM

BE301CM-02: Diameterintervall 20/26,6 mm

BE301CM-01, BE301CM-02

Kopplingscenteringsverktyg för SAC



BE301CM



15,19 mm 174 mm 20 BE301CM-01

20,26 mm 174 mm 20 BE301CM-02

BE301CM-02: Diameterintervall 20/26,6 mm

Centeringsverktyg för koppling



BE310



68 x 225 x 280 mm 1.14 kg

8 BE310

HJULUPPHÄNGNINGSVKTYG OCH UTRUSTNING

Fjädringsavlastare



BS25



20 Nm

200 kg

1 BS25

MacPherson fjäderspännarsats



BS15



125 x 425 x 510 mm

43 x 110 x 160 mm

165 x 160 x 385 mm

1 BS15

1 BS15125

1 BS15125C



42 x 160 x 160 mm

42 x 160 x 170 mm

42 x 160 x 212 mm

24 x 160 x 215 mm

45 x 56 x 95 mm

1 BS15160

1 BS15160C

1 BS15212

1 BS15212C

1 BS1550

Pneumatisk fjäderspännare med dubbla kolvar med skydds nät



BS30PG



1180 x 500 x 625 mm

24 kN

1 BS30PG

Adapter för fjäderspännare



BS10AC2



400 x 400 x 200 mm

1 kg

1 BS10AC2

Benställning med hjul



BS30AC1



336 x 545 x 450 mm

1 BS30AC1

Stötdämparhylsa



BS1000



70 x 405 x 575 mm

- 1 BS1000
- 1 BS100001
- 1 BS100002
- 1 BS100003
- 1 BS100004
- 1 BS100005
- 1 BS100006
- 1 BS100007
- 1 BS100008
- 1 BS100009
- 1 BS100010
- 1 BS100011
- 1 BS100012
- 1 BS100013
- 1 BS100014
- 1 BS100015
- 1 BS100016
- 1 BS100017
- 1 BS100018
- 1 BS100019
- 1 BS100020
- 1 BS100021
- 1 BS100022
- 1 BS100023
- 1 BS100024



- 1 BS100025
- 1 BS100026
- 1 BS100027
- 1 BS100028
- 1 BS100029
- 1 BS100030
- 1 BS100031
- 1 BS100032
- 1 BS100033
- 1 BS100034
- 1 BS100035
- 1 BS100036
- 1 BS100037
- 1 BS100038
- 1 BS100039

**BATTERIHANTERINGS- OCH
ELSYSTEMSVERKTYG**

Minnesadapter



BELMS12OBDL



40 x 70 x 140 mm

8 BELMS12OBDL

Starthjälp 12 V 1 200 CA



BBA12-1200



CA



12V

1200 A

1 BBA12-1200

Starthjälp 12/24 V 1 700/900 CA



BBA1224-1700

V CA



12/24 V

1700/900 A

1 BBA1224-1700

12/24V extra kraftig startbooster



BBA1224-3200

V CA



12/24 V

3200/1600 A

1 BBA1224-3200

12 V hybridbooster med kondensatorer



BBH12-1200

V CA



12V

1200 A

1 BBH12-1200



Batteri för 12V startboosters



BB1200A

V			
12V	28Ah	1	BB1200A

Helautomatisk 3 A-batteriladdare med underhållsfunktion för 12 V-batterier av blysyra- och LiFePO4 litumbatterier



BBCE12-3

V	A		
12V	3A	2	BBCE12-3

Helautomatisk 15 A-batteriladdare med underhållsfunktion för 12 V-batterier och Supply Mode



BBCE12-15S

V	A		
12V	10/15A	2	BBCE12-15S

Startkablar



BBJL

16 mm ²	3 m	5	BBJL1630
25 mm ²	3.5 m	1	BBJL2535
35 mm ²	4.5 m	1	BBJL3545

Helautomatisk 6 A-batteriladdare med underhållsfunktion för 12 V-batterier



BBCE12-6

V	A		
12V	6A	2	BBCE12-6

Helautomatisk 10 A-batteriladdare med underhållsfunktion för 24 V-batterier



BBCE24-10

V	A		
24V	10A	2	BBCE24-10

Helautomatisk 2 A-batteriladdare med underhållsfunktion för 6/12 V-batterier



BBCE612-2

V	A		
6-12V	2A	2	BBCE612-2

Helautomatisk 10 A-laddare med underhållsfunktion för 12 V-batterier



BBCE12-10

V	A		
12V	10A	1	BBCE12-10

Batteriladdare/strömkälla 100 A



BBCE12-F100

V	A		
12V	4/20/70/100AA	1	BBCE12-F100

Batteriladdare/starthjälp på hjul



BBC420-BBC620



230 V	20/1000 A-h	1	BBC420
230 V	20/1550 A-h	1	BBC620

Mätverktyg för batterisyradensitet



BB10

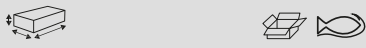

50 x 50 x 285 mm	1	BB10
------------------	---	------

12 V digital batteritestare



BBT20



90 x 160 x 345 mm	1	BBT20
-------------------	---	-------

12 V digital batteritestare



BBT60A

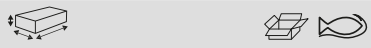

27 x 95 x 135 mm	36	BBT60A
------------------	----	--------

Digital batteritestare med skrivare, 6 och 12 V



BBT80

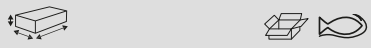

64 x 130 x 251 mm	6	BBT80
-------------------	---	-------

Digital multimeter, autointervall, faktisk RMS, 1 000 V, kan anslutas till dator



BMMTRMS1



155 x 60 x 225 mm	0.8 kg	1	BMMTRMS1
-------------------	--------	---	----------

Beröringsfri spänningsfrånvaroprovare 1 000 V



BMVAT1000



310 x 50 x 100 mm	0.302 kg	50	BMVAT1000
-------------------	----------	----	-----------

1 000 A AC/DC Äkta RMS digital eltestare med klämmor



BDACM1000



60 x 143 x 250 mm	0.551 kg	30	BDACM1000
-------------------	----------	----	-----------

IR & RF nyckeltestare



BELTKEY



35 x 63 x 160 mm	1	BELTKEY
------------------	---	---------



Elkontaktstestare, 7 stift 12 V



BELT127



35 x 63 x 160 mm

1 BELT127

Elkontaktstestare, 7 stift 12 V (24 n)



BELT247N



55 x 63 x 160 mm

1 BELT247N

Terminalverktygssats, 16 delar



BELTRP16



58 x 215 x 265 mm

- 1 BELTRP16
- 1 BELTRP1601
- 1 BELTRP1602
- 1 BELTRP1603
- 1 BELTRP1604
- 1 BELTRP1605
- 1 BELTRP1606
- 1 BELTRP1607
- 1 BELTRP1608
- 1 BELTRP1609
- 1 BELTRP1610
- 1 BELTRP1611
- 1 BELTRP1612
- 1 BELTRP1613
- 1 BELTRP1614
- 1 BELTRP1615
- 1 BELTRP1616

Belysningskontaktstestare 12 V



BELT1213A



40 x 138 x 205 mm 1.726 kg

20 BELT1213A

Elkontaktstestare, 7 stift 24 V (24 s)



BELT247S



35 x 63 x 155 mm

1 BELT247S

Belysningskontaktstestare 24 V



BELT2415A



40 x 138 x 205 mm 1.897 kg

20 BELT2415A

Gaslödkolvssats



BGIS125



25-125 W 46 x 88 x 295 mm 20 BGIS125

Minnesadapter 12 V



BELS12



35 x 63 x 160 mm

1 BELS12

Spänningskydd 12/24 V



BELP1224



35 x 63 x 160 mm



1 BELP1224

Batteriklämmor (snabbkoppling) för BBCE12-10 och BBCE24-10 laddare



BBCEC2



68 g



1 BBCEC2

Reservkablar till startboosterladdare



BBBCAB



50 x 125 x 50 mm
50 x 125 x 50 mm
50 x 50 x 50 mm



1 BBBCAB-AUZ
1 BBBCAB-EU
1 BBBCAB-UK

Batteriklämmor (snabbkoppling) för BBCE612-2, BBCE12-3 och BBCE12-6 laddare



BBCEC1



68 g



1 BBCEC1

Kabelskoanslutning (snabbanslutning) för BBCE12-10 och BBCE24-10 laddare



BBCER2



100 g



1 BBCER2

Säkring 16 A för startbooster



BBS702026



14 x 115 x 160 mm



15 g



15 BBS702026

Kabelskoanslutning (snabbkoppling) för BBCE612-2, BBCE12-3 och BBCE12-6 laddare



BBCER1



100 g



1 BBCER1

Automatisk elektronisk startboosterladdare



BBBC



55 x 85 x 165 mm
55 x 85 x 166 mm



1 BBBC2A
1 BBBC4A

Säkring 500A för startbooster



BBS702028



9 x 120 x 168 mm



500 A



1 BBS702028



Laddkabel för 12 V cigarettändaruttag. Till startbooster BBA12-1200, BBA1224-1700



BBSNL4FX001

26 x 50 x 50 mm	12 V	1	BBSNL4FX001

Laddningskabel för startboosterladdare, 12 V



BBACCC12V

	1	BBACCC12V

PRESSAR OCH TILLBEHÖR

Bänkprens, 15 ton



BH715

15.000 kg	1	BH715

Press för 20, 30 och 50 ton

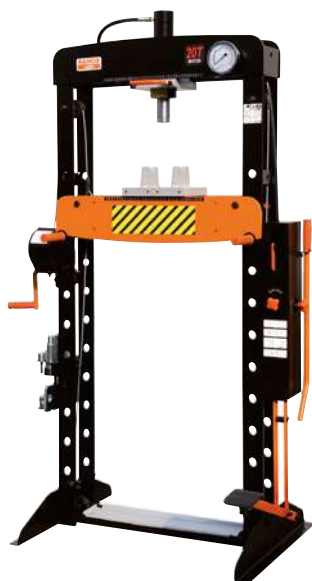

BH720/BH730/BH750

20.000 kg	1	BH720
30.000 kg	1	BH730
50.000 kg	1	BH750

Hydropneumatisk press, 100 ton



BH7100

100000 kg	1	BH7100A

Universalpressplatta för upp till 30 T



BH7PS30

225 x 100 x 275 mm	2	BH7PS30

Domsats med slagplatta



BH715-13

7.09 kg	1	BH715-13
7.09 kg	1	BH720-22

Skyddsgrind för pressar 15, 20 30 och 50 ton

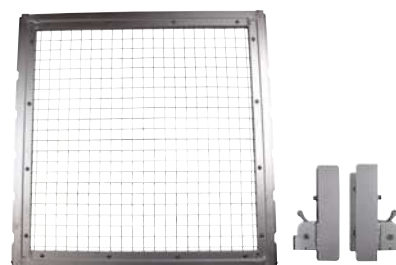

BH7 SG

530 mm	20 mm	1	BH720SG
590 mm	20 mm	1	BH730SG
625 mm	20 mm	1	BH750SG

Säkerhetsgaller för 100 tons press



BH7100SG



150 x 593 x 625 mm

5.54 kg

1 BH7100SG

VERKSTADSUTRUSTNING

Bord för många användningsområden



BLEMAT1



860 x 155 x 780 mm

28.7 kg

1 BLEMAT1

Underhylla för bord



BLEMAT1BT



50 x 760 x 890 mm

10.5 kg

1 BLEMAT1BT

Sats med 4 fälg-/däckskydd



BWB1418S4/BWB1922S4



355-470 mm

6 BWB1418S4

470-560 mm

6 BWB1922S4

Magnetisk rektangulär skål med plasthållare



BMR240



250 mm

1 BMR240

Magnetisk skål



1419-MD



150 mm

1 1419-MD

Montörspall



BLE305



430 x 410 x 430 mm

1 BLE305

Rund magnetisk skål



BMD150



160 mm

1 BMD150

Montörspall



BLE300



380 x 380 x 550 mm

136 kg

1 BLE300



Kombinerad montörsvagn och pall



BLE302

135 x 490 x 1010 mm	136 kg	1	BLE302

Klädselskydd



5750

1390 mm	1 5750

Lasertestutrustning för strålkastare



BLBT100

1650 x 500 x 565 mm	1 BLBT100

Montörsvagn, låg



BLE301

120 x 590 x 1020 mm	136 kg	1	BLE301

Karosskydd för front och skärmar



5770

350 x 300 x 85 mm	990 g	12	5770

Skena för BLBT100



BLBT100AC1

150 x 150 x 1025 mm	7.77 kg	1	BLBT100AC1

Sats med montörsvagn och pall



BLE304

460 x 1020 x 135 mm	116 / 100 kg	1	BLE304

Karosskydd



BBS50

900 mm	1,2 mm	1	BBS50

Sats med justerbara bräckjärn



BT10P3

80 x 270 x 375 mm	1 BT10P3

Justerbart bräckjärn



BT10P325-BT10P338



250 mm	40	BT10P325
300 mm	1	BT10P330
380 mm	1	BT10P338

Bräckjärnssats med gummigrepp



BPBLS4



78 x 255 x 1000 mm	9050 g	2	BPBLS4
--------------------	--------	---	--------

BPBL00900, BPBL30900, BPBL70600,
BPBL90600

Långt bräckjärn med gummigrepp



BPBL



930 mm	5	BPBL00900
925 mm	5	BPBL30900
610 mm	5	BPBL70600
628 mm	5	BPBL90600

KAROSSERIVERKTYG

Universalstativ med sugproppar i gummi



BBS3BH1



955 mm	1	BBS3BH1
--------	---	---------

Sugpropp för universalhållare



BBS3BH1-VP



60 x 95 x 95 mm	40	BBS3BH1-VP
-----------------	----	------------

Ställning för karossverkstäder



BBS3UH



950 x 800 x 1200 mm	20 kg	1	BBS3UH
---------------------	-------	---	--------

Sugkopp i gummi



BBS075



160 mm	175 mm	12	BBS075
--------	--------	----	--------

2 dubbla sugkoppar och rem



BBS150



120 mm	400 mm	1	BBS150
--------	--------	---	--------

Glasrensningsskrapa



BBS106



25 x 25 x 332 mm	0.145 kg	1	BBS106
------------------	----------	---	--------

Genomföringsnål med handtag



BBS103



25 x 25 x 345 mm	1	BBS103
------------------	---	--------



Genomföringsnål med t-handtag



BBS102

265 mm	1 BBS102

Två handtag för skärtråd



BBS101

30 x 80 x 115 mm	1 BBS101

Skärtråd för att skära loss vindrutor



BBS150S

50 m	1 BBS150R
50 m	1 BBS150S
50 m	1 BBS150T

Verktyg för att skära loss vindrutor



BBS105

20 x 90 x 200 mm	1 BBS105

Vindrutekniv



BBS10450

10 x 30 x 450 mm	0.240 kg
	1 BBS10450

Blad för att skära loss vindrutor



BBS107

1 x 18 x 125 mm	1 BBS107

Blad för att skära loss vindrutor



BBS108

20 x 19 x 88 mm	1 BBS108

Avdragare för vindrutetorkare



BBS165

117 x 25 x 78 mm	10 BBS165

Avdragare för vindrutetorkare



BBS170P13

80 x 275 x 375 mm	1 BBS170P13
	1 BBS170P131
	1 BBS170P132
	1 BBS170P133
	1 BBS170P134
	1 BBS170P135
	1 BBS170P136
	1 BBS170P137
	1 BBS170P138
	1 BBS170P139
	50 BBS165SP4

Glidhammare, 12 kg



BBS12SH



800 mm 12 kg 1 BBS12SH

Rikthammare med vinklat pen



BBSH2CA



40 mm 12 BBSH2CA

Rikthammare, lätt med slagyta F (flat) fyrkantig och C (konvex) rund



BBSH3CF30



30 mm 25 mm 6 BBSH3CF30

Rikthammare



BBSH1F



50x30 mm 1 BBSH1F

Rikthammare



BBSH2CP

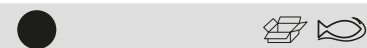

40 mm 6 BBSH2CP

Lätt krymphammare



BBSH3FS



37 mm 40 mm 6 BBSH3FS

Rikthammare



BBSH1M



50x30 mm 1 BBSH1M

Rikthammare



BBSH2F



40 mm 6 BBSH2F

Krymphammare



BBSH3MF



30 mm 27 mm 1 BBSH3MF

Rikthammare



BBSH2C

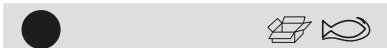

40 mm 1 BBSH2C

Rikthammare



BBSH3CF



40 mm 37 mm 6 BBSH3CF

Reservskaf för BBSH hammare



BBSHWH1



160 g 1 BBSHWH1



Mothåll, konvext



BBSDA



30 x 63 x 83 mm

1 BBSDA

Mothåll, tunn tå



BBSDT



26 x 58 x 120 mm

6 BBSDT

Kort dubbel sked



BBSS2



150 x 60 x 410 mm

8 BBSS2

Mothåll, kommaform



BBSDC



40 x 58 x 128 mm

6 BBSDC

Mothåll, kilformat



BBSDW



25 x 64 x 112 mm

6 BBSDW

Lång dubbel sked



BBSS2L



175 x 60 x 520 mm

2.3 kg

1 BBSS2L

Mothåll, runt



BBSDD



55 x 55 x 55 mm

1 BBSDD

Mothåll av gummi, hälformat



BBSDHR



40 x 62 x 75 mm

1 BBSDHR

Panelborttagare



2485



240 mm

1 2485

Mothåll, hälformat



BBSDH



30 x 60 x 79 mm

1 BBSDH

Enkel sked



BBSS1



25 x 56 x 390 mm

1 BBSS1

Tång för borttagning av dörrinredning



BBS200



240 mm

1 BBS200

Panelborttagare



BBS20P12



35 x 355 x 585 mm



1 BBS20P12

Reparationssats för plast



BBS210



100 x 280 x 360 mm
22 x 64 x 106 mm
22 x 64 x 106 mm
22 x 64 x 106 mm
22 x 64 x 106 mm
22 x 64 x 106 mm
22 x 64 x 106 mm
22 x 64 x 106 mm
22 x 64 x 106 mm
22 x 64 x 106 mm



1 BBS210
1 BBS210U06
1 BBS210U08
1 BBS210UA06
1 BBS210UA08
1 BBS210V06
1 BBS210V08
1 BBS210W06
1 BBS210W08

Verktygssats för borttagning av airbag-12 delar



BBS100



55 x 160 x 275 mm



1 BBS100
1 BBS10001



1 BBS10002
1 BBS10003
1 BBS10004
1 BBS10005
1 BBS100057
1 BBS10006
1 BBS10007
1 BBS10008
1 BBS10009
1 BBS10010

Sats med 4 st karosserispacklar



2220



125 g



1 22209004B

Mutternittång



1468-M6



20 x 110 x 265 mm



1 1468-M6

Mutternittång



1468-M10



50 x 210 x 575 mm



1 1468-M10

Munstycke till mutternittång 1468-M6



1468-6M



15 x 15 x 50 mm
13 x 13 x 50 mm
25 x 25 x 55 mm
20 x 20 x 55 mm



1 1468-6M3
1 1468-6M4
1 1468-6M5
1 1468-6M6

Munstycke till mutternittång 1468-M10



1468-10M



17 x 17 x 90 mm
17 x 17 x 90 mm
20 x 20 x 90 mm
20 x 20 x 85 mm
20 x 20 x 85 mm



1 1468-10M4
1 1468-10M5
1 1468-10M6
1 1468-10M8
1 1468-10M10



Skruv för 1468-M10



1468-10-1

70 g	1	1468-10-1

Bärbar riktssats, 4 och 10 ton



BH8PR

220 x 480 x 1030 mm 168 x 345 x 575 mm	31 kg 18.65 kg	1 BH8PR10000 1 BH8PR4000

Dragklämma



BH8BC2

51 x 150 x 220 mm	1	BH8BC2

Dragklämma



BH8BC3

90 x 65 x 240 mm	10	BH8BC3

Dragklämma



BH8BC4

80 x 120 x 175 mm	6	BH8BC4

Dragklämma



BH8BC5

45 x 155 x 230 mm	6	BH8BC5

LYFTUTRUSTNING

Pelardomkraft



BH4S

2000 kg 4000 kg 6000 kg 8000 kg 12000 kg 20000 kg 50000 kg	180 x 83 x 93 mm 190 x 91 x 100 mm 215 x 96 x 114 mm 230 x 103 x 120 mm 235 x 117 x 135 mm 240 x 145 x 153 mm 240 x 315 x 220 mm	6 BH4S2 6 BH4S4 4 BH4S6 4 BH4S8 3 BH4S12 1 BH4S20 1 BH4S50

Dragklämma



BH8BC1

45 x 135 x 230 mm	1	BH8BC1

Pelardomkraft, svetsad, premiumkvalitet



BH4

2000 kg 5000 kg	180 x 103 x 103 mm 210 x 110 x 110 mm	1 BH42 1 BH45

10000 kg	220 x 124 x 128 mm	1	BH410
15000 kg	235 x 140 x 140 mm	2	BH415
20000 kg	240 x 165 x 160 mm	1	BH420
30000 kg	245 x 185 x 175 mm	2	BH430

Lufthydraulisk pelardomkraft



50000 kg	300 x 210 x 310 mm	1	BH4HP50

1,5 tons domkraft, aluminium



1500 kg	170 x 370 x 660 mm	1	BH1A1500A

2,5 tons domkraft, aluminium



2500 kg	205 x 385 x 800 mm	1	BH1A2500A

3 tons domkraft



3000 kg	1400 x 340 x 617 mm	1	BH1EU3000

1 tons domkraft



1000 kg	1280 x 478 x 700 mm	1	BH1M1000

Extra låg ingångshöjd, extra lång räckvidd



1500 kg	1270 x 364 x 945 mm	1	BH11500

Extra låg ingångshöjd



2000 kg	1270 x 364 x 780 mm	1	BH12000

3 tons garagedomkraft



3000 kg	1280 x 364 x 825 mm	1	BH13000



Garagedomkraft för 3 ton med snabblyftfunktion



BH13000QA

3000 kg	220 x 395 x 900 mm	1	BH13000QA

Tvårbalksadapter, 1 ton



BH1CB1000

1000 kg	145 x 125 x 710 mm	1	BH1CB1000

Höglyftande garagedomkraft för 3 ton



BH13000L

3000 kg	1310 x 530 x 1370 mm	1	BH13000L

5T Extra lång garagedomkraft



BH15000B

5000 kg	330 x 520 x 1670 mm	1	BH15000B

10T Extra lång garagedomkraft



BH110000B

10000 kg	270 x 520 x 1670 mm	1	BH110000B

120 mm förlängningar för domkrafterna med artikelkod BH15000A och BH110000A



BH15000A-EXT/BH110000A-EXT

108 mm		1	BH15000A-EXT
151 mm		1	BH110000A-EXT

Truckdomkraft, 4–5 ton



BH1S45

4000 kg	1194 x 212 x 680 mm	1	BH1S45

Gummisadel, reservdel



BH1RS

BH1A1500A	40	BH1A1500A-05
BH1EU3000	1	BH1EU3000-03
BH11500, BH12000, BH13000, BH13000QA, BH13000L, BH1M1000, BH1A2500A	1	BH11500-04
BH15000A	1	BH15000A-04
BH110000A	1	BH110000A-04

Framhjul till domkraft



BH1 FW

BH1A2500	1	BH1A2500-03
BH13000	1	BH13000-02
BH1EU3000	1	BH1EU3000-01
BH1M1000, BH11500, BH12000	1	BH11500-02
BH1S45	1	BH1S45-03
BH15000A	1	BH15000A-02
BH110000A	1	BH110000A-02

Tvåstegs lufthydraulisk domkraft



BH9BJ22SSH

2000 kg	345 x 265 x 265 mm	1	BH9BJ22SSH

Trestegs lufthydraulisk domkraft



BH9BJ23

2000 kg	1000 x 250 x 250 mm	1	BH9BJ23SLH

Kompakt hydraulisk domkraft för 15–30 ton



BH23015C

30000 kg	1350 x 290 x 430 mm	1	BH23015C

Tvåstegs lufthydraulisk domkraft



BH9BJ22

2000 kg	1000 x 265 x 265 mm	1	BH9BJ22SLH

Förlängare för lufthydraulisk domkraft



BH9BJ260_80

970 g 1180 g	1 1	BH9BJ260 BH9BJ280

Lufthydraulisk domkraft för 30/15 ton



BH23015

30000 kg	1250 x 282 x 810 mm	1	BH23015

Lufthydraulisk domkraft, 30T



BH230

360 mm 627 mm	1	BH230	

Trestegs lufthydraulisk domkraft



BH9BJ23SSH

2000 kg	490 x 250 x 250 mm	1	BH9BJ23SSH

Lufthydraulisk domkraft med extra låg ingångshöjd



BH2402010

40000 kg	1225 x 302 x 825 mm	1	BH2402010



Lufthydraulisk domkraft



BH2604020

60000 kg	1250 x 295 x 875 mm	1	BH2604020

Extra kraftig lyftsadel



BH2AC60

0.97 kg	78 x 70 x 110 mm	1	BH2AC60V110
2.96 kg	80 x 140 x 140 mm	1	BH2AC60-140

Pallbock med automatisk lyftfunktion



BH3A

3000 kg	1	BH3A3000
5000 kg	1	BH3A5000
10000 kg	1	BH3A10000

Lufthydraulisk domkraft 80/50 ton



BH28050

80000 kg	380 x 470 x 1200 mm	1	BH28050

Pallbockar av aluminium, 1 par. Kapacitet 2500 kg



BH3AL2500

2500 kg	1	BH3AL2500

Pallbock med kvadratisk bottenplatta



BH3SQ

7000 kg	2	BH3SQ7000
15000 kg	2	BH3SQ15000

Adaptersats



BH2AC

67 mm	45-75 mm	1	BH2AC1
75 mm	45-75 mm	1	BH2AC2

Pallbockar (par)



BH33000/BH36000

3000 kg	1	BH33000
6000 kg	1	BH36000

Extra kraftig pallbock



BH3HD8000

8000 kg	2	BH3HD8000

Extra kraftig pallbock



BH3HD12000

12000 kg		1 BH3HD12000

Hydraulisk växellådslyft med en kolv, 500 kg kapacitet



BH5SP500QA

500 kg	2041 x 660 x 660 mm	1 BH5SP500QA

Transportvagn för bil



BH1CD680

16.22 kg	610 x 240 x 220 mm	1 BH1CD680

Extra kraftig pallbock



BH3HD16000

16000 kg		1 BH3HD16000

Hydraulisk växellådslyft med dubbla kolvar, 1 000 kg kapacitet



BH5DP1000QA

1000 kg	1954 x 759 x 759 mm	1 BH5DP1000QA

Ställ för transportvagnar



BH1CD680ST

715 x 130 x 155 mm	135 kg	1 BH1CD680ST

Extra kraftig pallbock för 20 ton



BH3HD20000A

20000 kg		1 BH3HD20000A

Universalsadel för växellådslyft



BH5US1000

250 x 340 x 420 mm	260-510 mm	1 BH5US1000

Hydraulisk hjulvagn för 600 kg



BH8AC3-600

1030 x 1050 x 1020 mm	93.5 kg	1 BH8AC3-600



Hjullyft



BH8AC3-1500

1730 x 1235 x 1425 mm 174 kg 1 BH8AC3-1500

Hjullyft, 1,5 ton



BH8AC3-1500A

310 x 1070 x 1345 mm 132 kg 1 BH8AC3-1500A

Hopfällbar verkstadskran, 600 kg



BH6PC600

2315 x 1040 x 1480 mm 96 kg 1 BH6PC600

Hopfällbar verkstadskran, 1 ton



BH6FC1000

2175 x 1030 x 1480 mm 85 kg 1 BH6FC1000

Hopfällbar verkstadskran, 2 ton



BH6FC2000

2640 x 1220 x 1845 mm 170 kg 1 BH6FC2000

Motorlyft med lastbalansering



BH6AC1-680A

565 x 12 x 774 mm 1 BH6AC1-680A

Elektriskt lyftbord med två hastigheter



RS1000

821 x 800 x 1821 mm 430 kg 1 RS1000

Tillbehörspatta med kullager för elektriskt lyftbord



RS1000TOP1

400 x 770 x 1430 mm
 110 kg

 1 RS1000TOP1

Plattform med kullager, för lyftbord RS1000 ,med gängade M10-hål



RS1000TOP2

400 x 765 x 1524 mm
 110 kg

 1 RS1000TOP2

Skivor för plattform med kullager, RS1000TOP1



RS1000PS0

8 x 700 x 1400 mm
 8.03 kg

 1 RS1000PS0

Skivor för plattform med kullager, RS1000TOP2



RS1000PS1

8 x 762 x 1524 mm
 12.22 kg

 1 RS1000PS1

Hydraulolja ISO VG15, 250 ml



BHVG15-250

160 x 60 x 60 mm
 220 g

 12 BHVG15-250

Bakhjul till domkraft



BH1_RW

BH1A1500	1	BH1A1500-04
BH1A2500	1	BH1A2500-04
BH1M1000, BH11500, BH12000, BH13000	1	BH11500-01
BH1EU3000	1	BH1EU3000-08
BH13000L	1	BH13000L-01
BH1S45-01	1	BH1S45-01
BH15000A, BH110000A	1	BH15000A-01



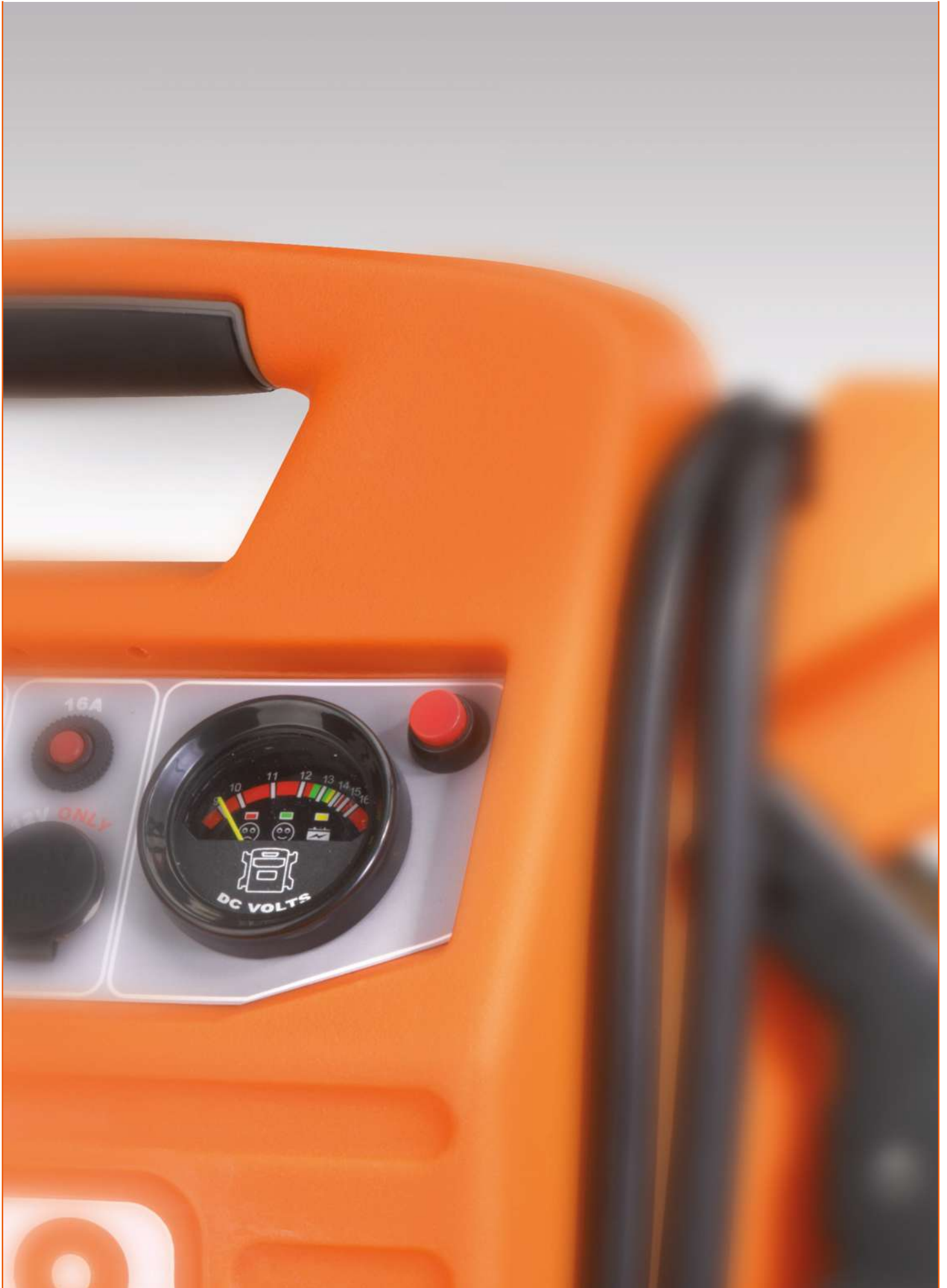

BAHCO



Belysningsutrustning



FICKLAMPOR

Ficklampor med ljusstråle



BLTS7P

45 lm	58	BLTS7P

Aluminium Flex arbetslampa



BLTFC1

180 lm	20	BLTFC1

360° sladdlösa LED-arbetslampor



BLS128

575 lm	20	BLS128

Smala arbetslampor med strålkastare



BLTS10

400 lm	20	BLTS10

STRÅLKASTARE

Pannlampa med resårband



BFRL11

260 lm	1	BFRL11

KABELVINDOR

2-fas 230 V AC kabelvindor utan lampa



BLCR230

230 V	800/2000 W	1	BLCR230FR
230 V	800/2000 W	1	BLCR230SC

Lampor med kabelvindor



BLCR24V

230/24 V	60 W	1	BLCR24VCL
230/24 V	60 W	1	BLCR24VLL

3-fas 400 V AC kabelvindor utan lampa



BLCR400E

400 V	2800/5000 W	1	BLCR400E

Hastighetskontrolladapterar för kabelvindor



BLCRSC

BLCR			
230PL,FR,SC	76 x 91 x 117 mm	1	BLCRSC1
24VCL,VLL	76 x 91 x 117 mm	1	BLCRSC2



Inspektionsverktyg



ENDOSKOP

Handhållna videoskop med 3,5" LCD-skärm



BE210

	kg	
105 x 325 x 400 mm	2.67 kg	1 BE210
5 x 50 x 56 mm	0.04 kg	1 ZHVIDEOBAT
40 x 44 x 75 mm	0.17 kg	1 ZHVIDEOCHA

Linskablar med fiberoptik för endoskop



BE200C

Ø	L	
25 mm	10 m	1 BE200CAB250SH10
25 mm	25 m	1 BE200CAB250SH25
25 mm	3 m	1 BE200CAB250SH3
4 mm	1 m	1 BE200CAB40F1
5.5 mm	1 m	1 BE200CAB55F1
5.5 mm	3 m	1 BE200CAB55F3
5.8 mm	1 m	1 BE200CAB58SR1
5.8 mm	3 m	1 BE200CAB58SR3
8 mm	1 m	1 BE200CAB80SR1
8 mm	3 m	1 BE200CAB80SR3

Spetsar med spegel och magnet för endoskop



BE200M

°		
0°	4	1 BE200MAG4
0°	5.5, 5.8, 8	1 BE200MAG55
		1 BE200MAG80
35°	5.5, 5.8	1 BE200MIR5535
45°	5.5, 5.8	1 BE200MIR5545
55°	5.5, 5.8	1 BE200MIR5555
35°	8	1 BE200MIR8035
45°	8	1 BE200MIR8045
55°	8	1 BE200MIR8055
35°	4	1 BE200MIR4035
45°	4	1 BE200MIR4045
55°	4	1 BE200MIR4055

STETOSKOP

Stetoskopsats för verkstad



BE220

	kg	
130 x 370 x 340 mm	2.94 kg	1 BE220

Stetoskop med stålsönd



5050

L	
1050 mm	1 5050

SPEGLAR

Förstorande verkstadsspeglar med led



5515GV

L	Ø	
215 mm	30 mm	1 5515GV

Vridbara teleskopspeglar 52 mm



5515T-52

L	Ø	
255-450 mm	52 mm	25 5515T-52

Ledad inspektionsspegel med LED-lampa och isolerad halvstel kabel



5515FL

L	Ø	
550 mm	62 x 38 mm	10 5515FL

Verkstadspeglar i plast



5515B

220 mm	28,5 mm	25	5515B

Små speglar med lampa och förstoring
18 mm



5515L

160 mm	21 mm	1	5515L

Reparationsspeglar med metallhandtag
30 mm



5515M

210 mm	30 mm	1	5515M

Teleskopiska fickspeglar med led



5515T

180-690 mm	30 mm	25	5515T





BAHCO

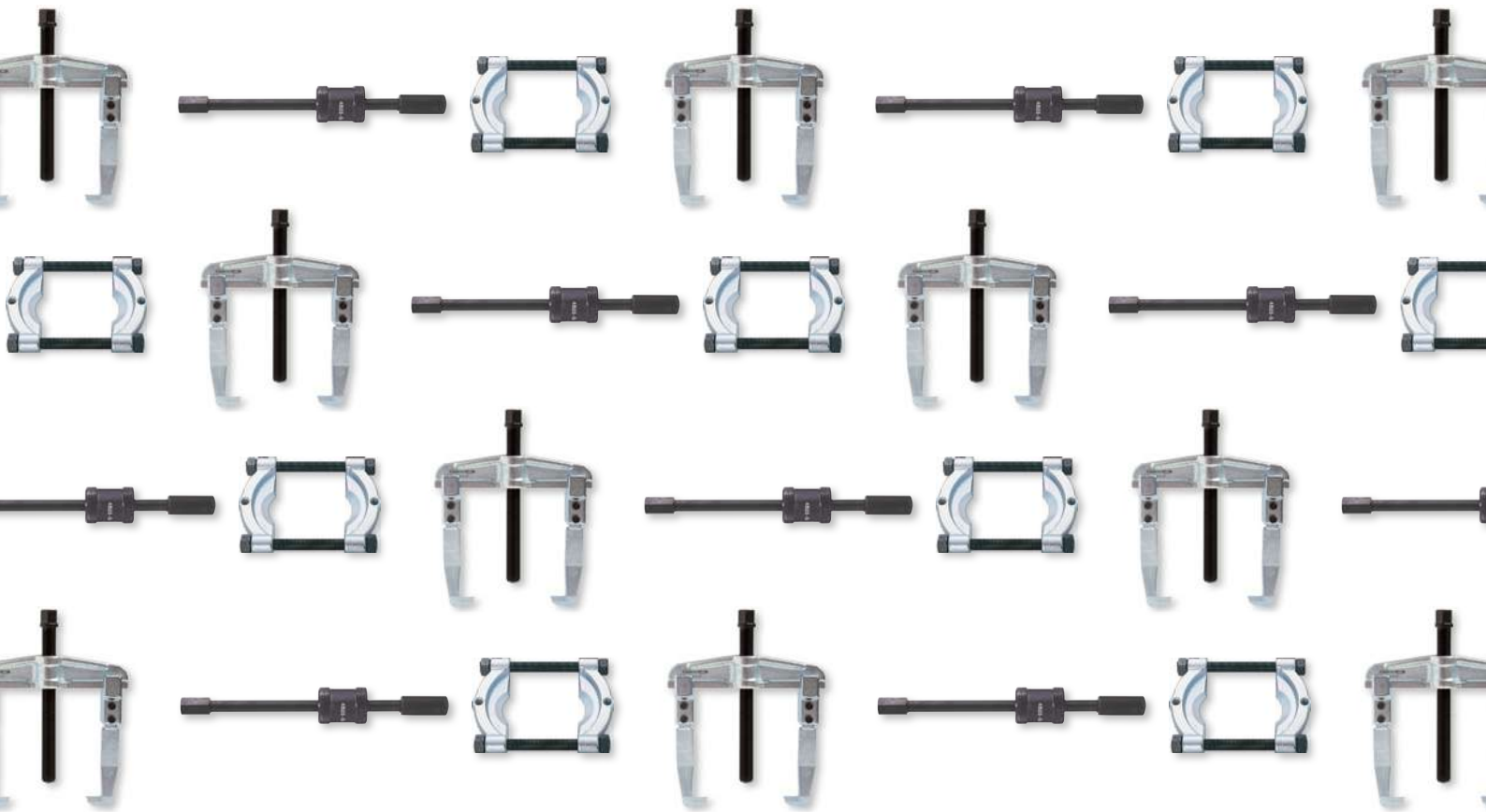

Avdragare och bräckjärn



MEKANISKA

Tvåarmad universalavdragare med induktionshärdad spindel och galvaniserad yta



4532

Spindel	Armar	Reservdelar	Artikelnr
25-80 mm	100 mm	1	4532-A
25-80 mm	200 mm	1	4532-AL
25-130 mm	100 mm	1	4532-B
25-130 mm	200 mm	1	4532-BL
50-160 mm	150 mm	1	4532-C
50-160 mm	300 mm	1	4532-CL
60-200 mm	150 mm	1	4532-D
80-250 mm	200 mm	1	4532-E
80-350 mm	200 mm	1	4532-F
110-520 mm	200 mm	1	4532-G
110-520 mm	300 mm	1	4532-G-SO
170-640 mm	225 mm	1	4532-H
	100 mm	1	4532K1
	150 mm	1	4532K2
	200 mm	1	4532K3
	225 mm	1	4532K4
	200 mm	1	4532LK1
	300 mm	1	4532LK2
	300 mm	1	4532LK3
	400 mm	1	4532LK4
	500 mm	1	4532LK5
		1	4532-OAB/S
		1	4532-CD/S
		1	4532-EFG/S
		1	4532-H/S

4532/B: Reservok 4532K: Par reservvarmar 4532LK: Par långa reservvarmar
4532/S: Reservspindel

Tvåarmad universalavdragare med galvaniserad yta



4532-0

Spindel	Armar	Reservdelar	Artikelnr
20-90 mm	100 mm	1	4532-0

4532-0/B: Reservkropp 4532K0: Ett par reservvarmar

Tvåarmad universalavdragare med långa armar, lång spindel och galvaniserad yta



3115

Spindel	Armar	Reservdelar	Artikelnr
80-250 mm	300 mm	1	3115

Display med tvåarmade universalavdragare, galvaniserad



4532ST/5

Vikt	Reservdelar	Artikelnr
16700 g	1	4532ST/5

4532-A, 4532-B, 4532-C, 4532-D, 4532-E

Trearmad avdragare



4533

Spindel	Armar	Reservdelar	Artikelnr
150-700 mm	185 mm	1	4533HP
150-700 mm	200 mm	1	4533M
	185 mm	1	4533HPK
	200 mm	1	4533MK
		1	4533HP/S
		1	4533M/S

4533HP: Hydraulisk 4533M: Mekanisk 4533/S: Reservspindel 4533/K: Sats med 3 reservvarmar

Hydraulisk press med galvaniserad yta



4529

T _n max	Armar	Reservdelar	Artikelnr
8 to 15 to	60 Nm	1	4529-8
	70 Nm	1	4529-15

Trearmad hydraulisk avdragare



4528

Spindel	Armar	Reservdelar	Artikelnr
50-350 mm	135 mm	1	4528-1
350 mm		1	4528-1/B
	135 mm	1	4528K1
	235 mm	1	4528K2
	285 mm	1	4528K3
	335 mm	1	4528K4
	385 mm	1	4528K5





4528K: Sats med 3 reservvarmar 4528/B: Reservkropp 4533HP/S: Hydraulisk reservspindel

Två-/trearmad extra kraftig avdragare med galvaniserad yta



4544

Spindel	Armar	Reservdelar	Artikelnr
10-100 mm	80 mm	1	4544-1
10-120 mm	120 mm	1	4544-2



			
20-160 mm	160 mm	1	4544-3
20-200 mm	200 mm	1	4544-4
10-100 mm	80 mm	1	4544-10
10-120 mm	120 mm	1	4544-20
20-160 mm	160 mm	1	4544-30
100 mm		1	4544-1/B
120 mm		1	4544-2/B
160 mm		1	4544-3/B
200 mm		1	4544-4/B
100 mm		1	4544-10/B
120 mm		1	4544-20/B
160 mm		1	4544-30/B
	80 mm	1	4544K110
	120 mm	1	4544K220
	160 mm	1	4544K330
	200 mm	1	4544K440
		1	4544-110/S
		1	4544-220/S
		1	4519-1/S
		1	4544-440/S

4544-1/4:w/2 armar 4544-10/30:w/3 armar 4544/B: reservkropp 4544K: reservarm 4544/S: reservspindel

Två-/trearmad lätt avdragare med galvaniserad yta



4543





			
10-60 mm	40 mm	1	4543-1
10-70 mm	74 mm	1	4543-2
10-90 mm	84 mm	1	4543-3
10-60 mm	40 mm	1	4543-10
10-70 mm	74 mm	1	4543-20
10-90 mm	84 mm	1	4543-30
70 mm		1	4543-12/B
90 mm		1	4543-3/B
70 mm		1	4543-1020/B
100 mm		1	4543-30/B
	40 mm	1	4543K110
	74 mm	1	4543K220
	84 mm	1	4543K330
		1	4543-1/S
		1	4543-2/S
		1	4543-3/S

4543-1/3:w/2 armar 4543-10/30:w/3 armar 4543/B: Reservkropp 4543K: Reservarm 4543/S: Reservspindel

Tvåarmad avdragare med galvaniserad yta



4541





			
20-150 mm	85 mm	1	4541-A
40-220 mm	130 mm	1	4541-B
150 mm		1	4541-A/B
220 mm		1	4541-B/B
	85 mm	1	4541KA
	130 mm	1	4541KB

4541/B: Reservkropp 4541K: Reservarm 4532-4519/S: Reservspindel

Trearmad avdragare med galvaniserad yta



4542





			
20-150 mm	85 mm	1	4542-A
40-220 mm	130 mm	1	4542-B
150 mm		1	4542-A/B
220 mm		1	4542-B/B





4542/B: Reservkropp 4542K: Reservarm 4532-4519/S: Reservspindel

Tvåarmad avdragare



4537

			
20-170 mm	130 mm	1	4537-1
20-230 mm	200 mm	1	4537-2
50-300 mm	250 mm	1	4537-3
50-350 mm	350 mm	1	4537-4
170 mm		1	4537-1/B
230 mm		1	4537-2/B





			
350 mm		1	4537-34/B
	130 mm	1	4537K1
	200 mm	1	4537K2
	250 mm	1	4537K3
	350 mm	1	4537K4

4537/B: Reservkropp 4537K: Reservarm 4532-4519/S: Reservspindel

Trearmad avdragare för expanderarna 4528M1/4528M2/4528M3



4528M





			
		1	4528M1/P
		1	4528M2/P
		1	4528M3/P
20-170 mm	130 mm	1	4528M1
20-230 mm	200 mm	1	4528M2
50-300 mm	250 mm	1	4528M3
50-350 mm	350 mm	1	4528M4
50-400 mm	400 mm	1	4528M5
170 mm		1	4528M1/B
230 mm		1	4528M2/B
400 mm		1	4528M345/B
	400 mm	1	4528MK5

4528M/B: Reservkropp 4537K-4528MK: Reservarm 4532/S-4519/S: Reservspindel

Tvåarmad avdragare med spännbygel och galvaniserad yta



4519

			
20-110 mm	80-170 mm	1	4519-1
40-150 mm	90-270 mm	1	4519-2
40-150 mm	90-330 mm	1	4519-3
110 mm		1	4519-1/B
150 mm		1	4519-23/B
	170 mm	1	4519K1
	270 mm	1	4519K2
	330 mm	1	4519K3
		1	4519-2/S

4519/B: reservkropp 4519K: reservarm 4519/S: reservspindel



Tvåarmad avdragare av saxtyp med galvaniserad yta



4614

✂		✂		📦	
6-100 mm	70-85 mm	1	4614-1		
10-140 mm	85-120 mm	1	4614-2		
100 mm		1	4614-1/B		
140 mm		1	4614-2/B		
	80 mm	1	4614K1		
	120 mm	1	4614K2		

4614/B: Reservkropp 4614K: Ett par reservarmar 4543-4532/S: Reservspindel

Flerarmad avdragare – 5 delar



4540

✂		✂		📦	
30-170 mm	65-140 mm	1	4540-17		
		1	4540-17/S		
75-250 mm	77-180 mm	1	4540-25		
		1	4540-25/S		

Separatoravdragare



4552

✂		📦	
4551-A-B		1	4552-1
4551-C		1	4552-2
4551-D		1	4552-3



- 1 4552-1/B
- 1 4552-2/B
- 1 4552-3/B
- 1 4552K1
- 1 4552K2
- 1 4552K3

4552/B: Reservkropp 4552K: Reservstagbult 4532/S: Reservspindel

Separator med galvaniserad yta



4551

✂		📦	
4552-1		1	4551-A
4552-1		1	4551-B
4552-2		1	4551-C
4552-3		1	4551-D
		1	4551-A/S
		1	4551-B/S
		1	4551-C/S
		1	4551-D/S

4551/S: reservstagbult

Sats med avdragare och separator med galvaniserad yta



4574

📦		📦	
105 x 300 x 360 mm		1	4574

4532-A, 4532-C, 4532LK1, 4532LK2

4551-C

4529-15

Kullageravdragare utan armar



4581N-4583N

✂		📦	
4581NA, 4581NB		1	4581N-1
4581NB2, 4581NC, 4582NA		1	4582N-1
4581NC, 4582NA, 4582NB		1	4582N-2
4582NA, 4583NA, 4583NB		1	4583N-1
4582NA, 4582NB, 4583NB		1	4583N-2

Sats med reservarmar för avdragare



4581NA-4583NB

✂		✂		📦	
145 mm	4581N-1	1	4581NA		
120 mm	4581N-1	1	4581NB		
130 mm	4582N-1	1	4581NB2		
130 mm	4582N-1, 4582N-2	1	4581NC		
150 mm	4582N-1, 4583N-2	1	4582NA		
150 mm	4582N-2, 4583N-2	1	4582NB		
190 mm	4583N-1	1	4583NA		
235 mm	4583N-1, 4583N-2	1	4583NB		

Sats med kullageravdragare med galvaniserad yta



4580N/7

📦		📦	
66 x 192 x 287 mm		1	4580N/7

4581N-1, 4582N-1, 4582N-2, 4583N-1, 4583N-2, 4581NA till 4583NB

Expandersats med galvaniserad yta för demontering av kullager



4578



75 x 235 x 285 mm



1 4578

4581N-1, 4582N-2, 4581NA, 4581NB, 4581NB2, 4581NC

Expandrar för invändiga kullager med mörkt gråblå yta



4521N



5-7 mm	1	4521N-00
7-9 mm	1	4521N-0
9-12 mm	1	4521N-A
10-13 mm	1	4521N-B
13-17 mm	1	4521N-C
14-19 mm	1	4521N-D
16-21 mm	1	4521N-E
18-23 mm	1	4521N-F
20-25 mm	1	4521N-G
25-30 mm	1	4521N-H
30-37 mm	1	4521N-I
35-42 mm	1	4521N-K
38-45 mm	1	4521N-L
43-50 mm	1	4521N-M
40-75 mm	1	4521N-S
70-115 mm	1	4521N-T

Tvåarmad avdragare med spindel och galvaniserad yta



4522



35-75 mm	1	4522-1
60-130 mm	1	4522-2
35-75 mm	1	4522-1/B
60-130 mm	1	4522-2/B
136 mm	1	4522K1
160 mm	1	4522K2
136 mm	1	4522-1/S
160 mm	1	4522-2/S

4522/B: Reservkropp 4522K: Reservarm 4522/S: Reservspindel

Glidhammare med mörkt gråblå yta för expandrar



4523G



Ø10x170 mm 1 4523G

Glidhammare med galvaniserad yta för expandrar



4524G



Ø16 x 250 mm 1 4524G

Komplett expandersats för verkstaden – 9 delar



4521N/7



95 x 360 x 310 mm 6800 g 1 4521N/7

4521N-B, 4521N-D, 4521N-H, 4521N-I, 4521N-L, 4521N-S, 4521N-G



4522-2, 4522-1



Kulledsavdragare med galvaniserad yta, för universalbruk



4545-N



Max 50 mm	18-22 mm	1	4545-N1
Max 90 mm	27-36 mm	1	4545-N11
Max 50 mm	26 mm	1	4545-N2
60-80 mm	26 mm	1	4545-N21
		1	4545-N1/S
		1	4545-N2/S

4545/S: Reservspindel

Hjulnavsavdragare med galvaniserad yta för universalbruk



4518



225 mm	140 mm	1	4518-3
225 mm	140 mm	1	4518-4
225 mm	140 mm	1	4518-5



Kulledsavdragare med galvaniserad yta



4545

Storlek	Antal	Varuslag
18 mm	1	4545-1
25 mm	1	4545-2
29 mm	1	4545-3
40 mm	1	4545-4
45 mm	1	4545-5

Avdragarsats för bilunderhåll



4577

Storlek	Antal	Varuslag
70 x 340 x 425 mm	1	4577

4545-N2	
4532-B	
4614-1	
4521N-D, 4521N-B, 4521N-H, 4521N-I, 4521N-G, 4521N-L	
4522-1	

Sats med intern och extern avdragare med glidhammare



4590SHS5

Storlek	Antal	Varuslag
79 x 230 x 500 mm	4	4590SHS5

Sats med små avdragare med galvaniserad yta



4579

Storlek	Antal	Varuslag
65 x 210 x 275 mm	1	4579

4543-2, 4543-3, 4543-1020/B, 4543-30/B, 4543K220, 4543K330

Hydraulisk muttersprängare med galvaniserad mörkt gråblå yta



4610

Storlek	Antal	Varuslag
M4-M14	1	4610-1

Mekanisk muttersprängare med galvaniserad mörkt gråblå yta



4611

Storlek	Antal	Varuslag
to M16	1	4611-2
to M24	1	4611-3

4611/S: Reservblad 4611/B: Reservspindel

Reservmejslar för muttersprängare



4611/B

Storlek	Antal	Varuslag
60 g	1	4611-2/B
60 g	1	4611-3/B

Reservspindlar för muttersprängare 4611-2 och 4611-3



4611/S

Storlek	Antal	Varuslag
90 g	1	4611-2/S
130 g	1	4611-3/S

Förkromad pinnbultsavdragare



4553

5-20 mm	1	4553

Pinnbultsavdragare med galvaniserad och mörkt gråblå yta



4591-4593

10-19 mm	1	4592
5-15 mm	1	4591
18-28 mm	1	4593

Skruvutdragare med rullgänga



1420-1424

M 3-6	1	1420-1.4
M 6-8	1	1421-2.1
M 8-11	1	1422-3.1
M11-14	1	1423-4.8
M14-18	1	1424-6.2

Skruvutdragare-5 st.



1435/5

15 x 50 x 90 mm	110 g	1	1435/5

1423-4.8, 1420-1.4, 1422-3.1, 1421-2.1, 1424-6.2

Skruvutdragare-8 st.



1435/8

29 x 110 x 118 mm	700 g	1	1435/8

M18-24 + M24-33 + M33-45

1420-1.4, 1421-2.1, 1422-3.1, 1423-4.8, 1424-6.2

Skruvutdragare för avbrutna skruvar, bultar och pinnbultar, M5-M24



1419-M5/1419-M16

M5-M10	1	1419-M5
M8-M14	1	1419-M8
M12-M20	1	1419-M12
M16-M24	1	1419-M16

Skruvutdragarsats för avbrutna skruvar, bultar och pinnbultar - 4 delar



1419/4

M5-M24	430 g	1	1419/4

M5-M10; M8-M14; M12-M20; M16-M24

Skruvutdragarsats - 15 delar



BWMSp15

43 x 90 x 200 mm	0.54 kg	1	BWMSp15

Skruvutdragarbiter med blåstrad yta



BWMSp15

3 mm	13 mm	1	BWMSp1501
4 mm	13 mm	1	BWMSp1502
5 mm	13 mm	1	BWMSp1503
5.5 mm	13 mm	1	BWMSp1504
6 mm	13 mm	1	BWMSp1505
8 mm	13 mm	1	BWMSp1506
10 mm	13 mm	1	BWMSp1507
1/8 in	13 mm	1	BWMSp1508
3/16 in	13 mm	1	BWMSp1509
1/4 in	13 mm	1	BWMSp1510
3/8 in	13 mm	1	BWMSp1511
11 mm	16 mm	1	BWMSp1512
12 mm	16 mm	1	BWMSp1513
14 mm	16 mm	1	BWMSp1514
1/2 in	16 mm	1	BWMSp1515



Skruvutdragare för avbrutna skruvar/bultar/
pinnbultar M5-M16



1418S



25 x 127 x 162 mm M6-M16 1 1418S

G220 HSS-M: 3.2, 4.8, 6.4, 8, 8.7 mm DIN 338RN

1411-3.2, 1412-4.8, 1413-6.4, 1414-8, 1415-8.7

Skruvutdragare i stållegering



1418

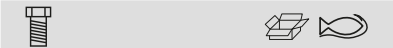

M5-M8	1	1418-4
M8-M10	1	1418-5
D11-M12	1	1418-6
M12-M14	1	1418-7.5
M14-M16	1	1418-8.5

BRÄCKJÄRN

Kombinationsbräckjärn med sexkantigt
skaft



2632



170 mm 1 2632

Bräckjärn med platt huvud och sexkantigt
skaft



3684



406 mm	1	3684-16
457 mm	1	3684-18
609 mm	1	3684-24
760 mm	1	3684-30

Bräckjärn med platt huvud och platt skaft



3680



400 mm	1	3680
--------	---	------

Bräckjärn med platt huvud och PP-handtag



2484-20/2484-60



205 mm	1	2484-20
305 mm	1	2484-30
465 mm	1	2484-45
615 mm	1	2484-60

Bräckjärn med platt huvud och handtag
i PVC



2484/S4



42 x 145 x 693 mm 10 2484/S4

2484-20, 2484-30, 2484-45, 2484-60

Bräckjärn med genomgående klinga som
tål slag med hammare



2484T-20/2484T-60

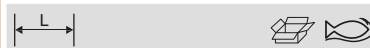

210 mm	1	2484T-20
312 mm	1	2484T-30
450 mm	1	2484T-45
600 mm	1	2484T-60

4 st. bräckjärn med genomgående klinga
som tål slag med hammare



2484T/S4



42 x 145 x 693 mm 1950 g 1 2484T/S4

2484T-20, 2484T-30, 2484T-45,
2484T-60

Bräckjärn med rundat huvud



3683



400 mm



1 3683

Bräckjärn med rundat huvud och svartoxiderat skaft



3681



304 mm

406 mm

503 mm



1 3681-11

1 3681-16

1 3681-20

PLOCKNINGSVERKTYG

ERGO™ upplockare med neodymmagnet, 4 x 290 mm



ergo

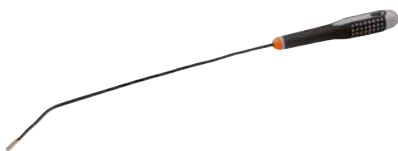

2535F0



5.5 mm



515 mm



1 2535F0

BahcoFit magnetisk upplockare med gummigrepp 10–18 mm



B147



13 mm

19 mm



400 mm

400 mm



1 B147.001.400

1 B147.003.400

Flexibla upplockningsverktyg med stålkärna



2509



555 mm



50 2509

Magnetiskt upplockningsverktyg ERGO™



ergo



2535F



10 mm

10 mm

17 mm



400 mm

400 mm

400 mm



1 2535F1

1 2535F2

1 2535F3

Upplockningsverktyg med klo, med stålkärna



2530



605 mm



1 2530

GÄNGVERKTYG

Sats med gängskärningsverktyg – 37 delar



1460M/1



53 x 407 x 220 mm M5-M12



1 1460M/1

Magnetiskt upplockningsverktyg med lampa



2535L



20 mm



40-670 mm



12 2535L



Sats med gängskärningsverktyg-55 delar



1460M/2

53 x 407 x 220 mm M5-M20 1 1460M/2

Gängtappshållare, förkromad



600

3-10 mm 1 600.003.010
5-12 mm 1 600.005.012

Gängfilssats för ytter- och innergånga



1450D-WW

230 mm 1 1450D-WW

Sats med gängskärningsverktyg-54 delar



1460Z/2

53 x 407 x 220 mm 1/4-3/4 1 1460Z/2

Dubbel gängfil, metrisk



1450D-ISO

230 mm 1 1450D-ISO

Gängfilssats i trälåda, för ytter- och innergånga



1450D/2

40 x 70 x 270 mm M5-M27 1 1450D/2

1450D-ISO
1450D-WW





Verktögsförvaring och verktögsseter



VERKTYGSVAGNAR

26" Premium E77 verktygsvagn med 6 lådor



1477K6



976 x 510 x 820 mm	1	1477K6
976 x 510 x 820 mm	1	1477K6BLACK
976 x 510 x 820 mm	1	1477K6GREY
976 x 510 x 820 mm	1	1477K6WHITE
976 x 510 x 820 mm	1	1477K6RED

26" Premium E77 verktygsvagn med 7 lådor



1477K7



976 x 510 x 820 mm	1	1477K7
976 x 510 x 820 mm	1	1477K7BLACK
976 x 510 x 820 mm	1	1477K7GREY
976 x 510 x 820 mm	1	1477K7WHITE
976 x 510 x 820 mm	1	1477K7RED

26" Premium E77 verktygsvagn med 8 lådor



1477K8



976 x 510 x 820 mm	1	1477K8
976 x 510 x 820 mm	1	1477K8BLACK



976 x 510 x 820 mm	1	1477K8GREY
976 x 510 x 820 mm	1	1477K8WHITE
976 x 510 x 820 mm	1	1477K8RED

26" Premium E77 verktygsvagn med 9 lådor



1477K9



976 x 510 x 820 mm	1	1477K9
976 x 510 x 820 mm	1	1477K9BLACK
976 x 510 x 820 mm	1	1477K9GREY
976 x 510 x 820 mm	1	1477K9WHITE
976 x 510 x 820 mm	1	1477K9RED

26" E72 verktygsvagn med 5 lådor



1472K5



952 x 510 x 782 mm	1	1472K5
952 x 510 x 782 mm	1	1472K5BLACK
952 x 510 x 782 mm	1	1472K5GREY
952 x 510 x 782 mm	1	1472K5WHITE
952 x 510 x 782 mm	1	1472K5RED
952 x 510 x 782 mm	1	1472K5BLUE

26" E72 verktygsvagn med 6 lådor



1472K6



952 x 510 x 782 mm	1	1472K6
952 x 510 x 782 mm	1	1472K6BLACK
952 x 510 x 782 mm	1	1472K6GREY
952 x 510 x 782 mm	1	1472K6WHITE
952 x 510 x 782 mm	1	1472K6RED
952 x 510 x 782 mm	1	1472K6BLUE

26" E72 verktygsvagn med 7 lådor



1472K7



952 x 510 x 782 mm	1	1472K7
952 x 510 x 782 mm	1	1472K7BLACK
952 x 510 x 782 mm	1	1472K7GREY
952 x 510 x 782 mm	1	1472K7WHITE
952 x 510 x 782 mm	1	1472K7RED
952 x 510 x 782 mm	1	1472K7BLUE

26" E72 verktygsvagn med 8 lådor



1472K8



952 x 510 x 782 mm	1	1472K8
952 x 510 x 782 mm	1	1472K8BLACK

BAHCO

BLACK GREY WHITE RED BLUE



952 x 510 x 782 mm	1	1472K8GREY
952 x 510 x 782 mm	1	1472K8WHITE
952 x 510 x 782 mm	1	1472K8RED
952 x 510 x 782 mm	1	1472K8BLUE

Premium E87 överskåp för förvaring av verktyg med 4 lådor



1487K4



402 x 510 x 692 mm	1	1487K4
402 x 510 x 692 mm	1	1487K4BLACK
402 x 510 x 692 mm	1	1487K4GREY

26" E72 överskåp för HUB-förvaring med 4 lådor



1482K4



386 x 510 x 692 mm	1	1482K4
386 x 510 x 692 mm	1	1482K4BLACK
386 x 510 x 692 mm	1	1482K4GREY
386 x 510 x 692 mm	1	1482K4WHITE
386 x 510 x 692 mm	1	1482K4RED
386 x 510 x 692 mm	1	1482K4BLUE

Premium E87 överskåp för HUB-förvaring på hjul med 4 lådor



1487K4W



564 x 510 x 692 mm	1	1487K4W
564 x 510 x 692 mm	1	1487K4BKW

26" E72 överskåp för HUB-förvaring på hjul med 4 lådor



1482K4W



542 x 515 x 699 mm	1	1482K4W
542 x 515 x 699 mm	1	1482K4BKW

26" E72 överskåp för HUB-förvaring på hjul med 5 lådor



1482K5W



542 x 515 x 699 mm	1	1482K5W
--------------------	---	---------

Verktygstavor för verktygsvagn 1477K



1477K-AC12



396 x 25 x 610 mm	1	1477K-AC12
-------------------	---	------------

Verktygspanel för sidan på verktygsvagnar i serien 1477K



1477K-AC13



400 x 25 x 365 mm	1	1477K-AC13
-------------------	---	------------

Dokumenthållare för verktygsvagnar i serien 1477K



1477K-AC14



327 x 25 x 240 mm	1	1477K-AC14
-------------------	---	------------



Laptop-hållare för verktygsvagn 1477K



1477K-AC15



80 x 298 x 424 mm



1 1477K-AC15

Hållare för vindruta för verktygsvagnar i serien 1477K



1477K-AC16



106 x 115 x 208 mm



1 1477K-AC16

Hållare för pappersrulle för verktygsvagn 1477K och 1472K



1477K-AC18



33 x 265 x 313 mm



1 1477K-AC18

Klädhängare för verktygsvagn 1477K



1477K-AC17



68 x 65 x 435 mm



1 1477K-AC17

Avtagbara långa stolpar för verktygsvagnar i serien 1477K



1477K-AC28



455 x 25 x 25 mm



1 1477K-AC28

Dokumenthållare för verktygsvagn 1477K och 1472K



1477K-AC19



241 x 65 x 300 mm



1 1477K-AC19

Stabil ring och klo för montering, för verktygsvagnar i serien 1477K



1477K-AC11



30 x 39 x 68 mm



1 1477K-AC11

Avtagbara korta stolpar för verktygsvagnar i serien 1477K



1477K-AC29



130 x 25 x 25 mm



1 1477K-AC29

Burkhållare för verktygsvagn 1477K och 1472K



1477K-AC20



125 x 105 x 307 mm



1 1477K-AC20

Hållare för el- och tryckluftsverktyg, för verktygsvagnar i serierna 1477K och 1472K



1477K-AC21



115 x 175 x 302 mm



1 1477K-AC21

Avtagbara lådadelare för vagn 1477K för förvaring av HUB-verktyg



1477K-AC26



48 x 2 x 147 mm 0.07 kg



1 1477K-AC26

Låssystem Mifare för verktygsvagnar i serien 1477K



1477K-AC25



135 x 36 x 62 mm



1 1477K-AC25

Verktygspanel för sidan på verktygsvagn 1477K och 1472K



1477K-AC22



659 x 18 x 300 mm



1 1477K-AC22

Bottenlåda för verktygsvagnar i serien 1477K



1477K-AC10



110 x 390 x 495 mm



1 1477K-AC10

Bänkskiva i rostfritt stål för mittleden på 1477K & 1487K Storage HUB verktygsvagnar



1477K-ACTSS



20 x 510 x 550 mm



1 1477K-ACTSS

Fällbar hylla för vagnarna 1472K och 1477K



1477K-AC30



22 x 430 x 460 mm



1 1477K-AC30

PIN-kodslås för verktygsvagnar i serien 1477K



1477K-AC24



135 x 36 x 62 mm



1 1477K-AC24

Bänkskiva av trä för mittleden på 1477K & 1487K Storage HUB verktygsvagnar



1477K-ACTW



20 x 510 x 550 mm



1 1477K-ACTW



Bänkskiva av komposit för 1477K Storage HUB verktygsvagn



1477K-ACTP



20 x 510 x 550 mm



1 1477K-ACTP

Bänkskiva i kastanjeträ för verktygsvagn, 1472K och 1482K



1472K-ACTW



30 x 501 x 680 mm



1 1472K-ACTW

Ark med dekaler för verktygsvagnar i serierna 1477K, 1472K och 1475K



1477K-AC23



1 x 210 x 300 mm



1 1477K-AC23

Bänkskiva av MDF för verktygsvagn 1477K



1477K-ACTD



20 x 510 x 550 mm



1 1477K-ACTD

MDF-bänkskiva för verktygsvagn, 1472K och 1482K



1472K-ACTD



30 x 501 x 682 mm



1 1472K-ACTD

26" låg verktygsvagn med 7 lådor



1470K7LH



755 x 501 x 760 mm
755 x 501 x 760 mm
755 x 501 x 760 mm
755 x 501 x 760 mm



1 1470K7LH
1 1470K7LHBLUE
1 1470K7LHGREY
1 1470K7LHRED

Rostfri bänkskiva för verktygsvagn 1472K och 1482K



1472K-ACTSS



30 x 501 x 682 mm



1 1472K-ACTSS

Nyckelring för verktygsvagn



KEYRING



10 x 30 x 70 mm 0.20 kg



50 KEYRING

26" klassisk C75 verktygsvagn med 6 lådor



1475K6



956 x 501 x 763 mm
956 x 501 x 763 mm
956 x 501 x 763 mm
956 x 501 x 763 mm



1 1475K6
1 1475K6BLACK
1 1475K6BLUE
1 1475K6RED

26" klassisk C75 verktygsvagn med 7 lådor



1475K7

956 x 501 x 763 mm	1	1475K7
956 x 501 x 763 mm	1	1475K7BLACK
956 x 501 x 763 mm	1	1475K7BLUE
956 x 501 x 763 mm	1	1475K7RED

40" klassisk C75 verktygsvagn med 6 lådor och sidoskåp



1475KXL6C

986 x 501 x 1100 mm	1	1475KXL6C
986 x 501 x 1100 mm	1	1475KXL6CBLACK

40" klassisk C75 verktygsvagn med 12 lådor



1475KXL12

986 x 501 x 1100 mm	1	1475KXL12
986 x 501 x 1100 mm	1	1475KXL12BLACK
986 x 501 x 1100 mm	1	1475KXL12RED

26" klassisk C75 verktygsvagn med 8 lådor



1475K8

956 x 501 x 763 mm	1	1475K8
956 x 501 x 763 mm	1	1475K8BLACK
956 x 501 x 763 mm	1	1475K8BLUE
956 x 501 x 763 mm	1	1475K8RED

40" klassisk C75 verktygsvagn med 7 lådor



1475KXL7

986 x 501 x 1100 mm	1	1475KXL7
986 x 501 x 1100 mm	1	1475KXL7BLACK
986 x 501 x 1100 mm	1	1475KXL7BLUE
986 x 501 x 1100 mm	1	1475KXL7RED

53" specialverktygsvagn med 8 lådor och sidoskåp



1475KXXL8CWTS

1218 x 500 x 1505 mm	1089 kg	1 1475KXXL8CWTS

40" klassisk C75 verktygsvagn med 6 lådor



1475KXL6

986 x 501 x 1100 mm	1	1475KXL6
986 x 501 x 1100 mm	1	1475KXL6BLACK
986 x 501 x 1100 mm	1	1475KXL6BLUE
986 x 501 x 1100 mm	1	1475KXL6RED

40" Classic C75 verktygsvagn med 8 lådor



1475KXL8

986 x 501 x 1100 mm	1	1475KXL8
986 x 501 x 1100 mm	1	1475KXL8BLACK
986 x 501 x 1100 mm	1	1475KXL8BLUE
986 x 501 x 1100 mm	1	1475KXL8RED

53" verktygsvagn med dubbelbänk och 12 lådor



1471KXXL12BKTSS

1016 x 501 x 1440 mm	1	1471KXXL12BKTSS



53" verktygsvagn med 7 lådor



1476KXXL7BK



986 x 501 x 1430 mm



1 1476KXXL7BK

Vikbar hylla för 1475K-serien



1470K-AC1



9 x 455 x 395 mm



1 1470K-AC1

Dokumenthållare för 1475K-serien



1470K-AC4



180 x 83 x 360 mm



1 1470K-AC4

26" C85 Classic överskåp med 4 lådor



1485K4



417 x 500 x 677 mm
417 x 500 x 677 mm
417 x 500 x 677 mm
417 x 500 x 677 mm



1 1485K4
1 1485K4BLACK
1 1485K4BLUE
1 1485K4RED

Hållare för 23 st skruvmejslar/bräckjärn

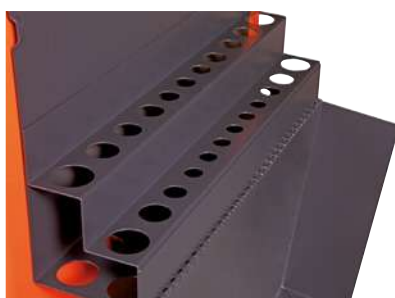

1470K-AC2



280 x 100 x 428 mm



1 1470K-AC2

Sidopaneler i metall, med spår och hål



1470K-ACSIDE



822 x 20 x 418 mm



1 1470K-ACSIDE

40" C85 Classic överskåp med 4 lådor



1485KXL4



417 x 500 x 1016 mm
417 x 500 x 1016 mm
417 x 500 x 1016 mm
417 x 500 x 1016 mm



1 1485KXL4
1 1485KXL4BLACK
1 1485KXL4BLUE
1 1485KXL4RED

Burkhållare för 1475K-serien



1470K-AC3



140 x 90 x 457 mm



1 1470K-AC3

26" bänkskiva i ABS-plast, för 26" verktygsvagnar



1470K-AC7



45 x 497 x 674 mm



1 1470K-AC7

Sidopaneler i metall för kroksystem
1495TP



1475K-ACSIDE



822 x 20 x 418 mm



1 1475K-ACSIDE

Sidoskåp med lås för vagn 1475KXL



1475KXL-AC20BK



820 x 503 x 419 mm



1 1475KXL-AC20BK

Bänkskiva av MDF för verktygsvagn, 40 mm



1470K-ACTD



40 x 495 x 1012 mm
40 x 497 x 674 mm



1 1470KXL-ACTD
1 1470K-ACTD

Verktystavlor för verktygsvagn i 1475K
26"



1470K-AC8



850 x 25 x 680 mm
850 x 25 x 680 mm



1 1470K-AC8
1 1470K-AC8GR

Tillbehör finns, t ex krokar, hållare, brickor. Se avsnittet om verktygsskåp och paneler

Rostfri bänkskiva för verktygsvagn, 40 mm



1475KXXL-ACTSS



45 x 495 x 1347 mm



1 1475KXXL-ACTSS

Bänkskiva i kastanjeträ för verktygsvagn
1475XXL



1475KXXL-ACTW



45 x 495 x 1347 mm



1 1475KXXL-ACTW

Justerbara metallhyllor för sidoskåp



1470KXLC-TRAY



470 x 10 x 310 mm



1 1470KXLC-TRAY

Bänkskiva av kastanjeträ för verktygsvagn,
40 mm



1470K-ACTW



40 x 500 x 1012 mm
40 x 497 x 674 mm



1 1470KXL-ACTW
1 1470K-ACTW

Lådinlägg - 7-pack



1470KAC1



100 x 445 x 543 mm



1 1470KAC01



Aluminiumvagn med två hyllor



1470KC2



1051 x 435 x 764 mm



1 1470KC2

Rullvagn med tre hyllor i stål



1470KC3A



1051 x 435 x 764 mm



1 1470KC3A

Multifunktionell aluminiumvagn med två hyllor



1470KC5



1051 x 435 x 1381 mm



1 1470KC5

1051 x 435 x 1381 mm

1 1470KC5PC

Mitthylla för rullvagn 1470KC2

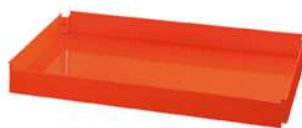

1470KCTRAY



750 mm



420 mm



1 1470KCTRAY

Hopfällbara säckkärria med lastyta i aluminium



1430FT120



1077 x 520 x 487 mm



6.4 kg



1 1430FT120

FIT&GO VERKTYGSSATSER I SKUMPLASTINLÄGG

Fit&Go 1/3 skumplastinlägg med 4 spår- och 3 Phillips®-skruvmejslar – 7 delar



FF1E1001



38 x 181 x 445 mm



1 FF1E1001

BE-8030, BE-8040, BE-8242, BE-8252



BE-8610, BE-8620, BE-8623



Fit&Go 1/3 skumplastinlägg med 5 spår- och 2 Phillips®-skruvmejslar – 7 delar



FF1E1002



39 x 181 x 445 mm



1 FF1E1002

BE-8242, BE-8040, BE-8030



BE-8257, BE-8255



BE-8611, BE-8621



Fit&Go 1/3 skumplastinlägg med skruvmejslar för spår- och Pozidriv®-skruv – 6 delar



FF1E1003



38 x 181 x 445 mm



1 FF1E1003

BE-8240



BE-8150, BE-8255, BE-8256



BE-8810, BE-8820



Fit&Go 1/3 skruvmejslar för spår-, Phillips- och Pozidriv®-skruv i skumplastinlägg – 8 delar



FF1E1004



40 x 181 x 445 mm



1 FF1E1004

BE-8340, BE-8350		
BE-8600, BE-8610		
BE-8811, BE-8800, BE-8820L, BE-8821		

Fit&Go 1/3 skumplastinlägg med skruvmejslar för spår-, Phillips®, Pozidriv® och insexskruv – 7 delar

ergo®



FF1E1005

40 x 181 x 445 mm	1 FF1E1005

BE-8210, BE-8010		
BE-8811, BE-8821, BE-8800		
BE-8600		
BE-8830		

Fit&Go 1/3 skumplastinlägg med skruvmejslar för spår-, Phillips®- och Pozidriv®-skruv – 6 delar

ergo®



FF1E1006

40 x 181 x 445 mm	1 FF1E1006

BE-8210		
BE-8610, BE-8620		
BE-8630		
BE-8811, BE-8820		

Fit&Go 3/3 skumplastinlägg med Torx®-skruvmejslar T10–T40 – 6 delar

ergo®



FF1E1007

40 x 181 x 445 mm	1 FF1E1007

BE-8910, BE-8915, BE-8920, BE-8925, BE-8930, BE-8940		
--	--	--

Fit&Go 1/3 skumplastinlägg med Torx® TR-skruvmejslar med centrumspets TR10–TR40 – 6 delar

ergo®



FF1E1008

38 x 181 x 445 mm	1 FF1E1008

BE-7910, BE-7930, BE-7925, BE-7920, BE-7915, BE-7940		
--	--	--

Fit&Go 1/3 TORX® skruvmejselsats T8–T30 i skumplastinlägg–6 delar

ergo®



FF1E1009

38 x 181 x 445 mm	1 FF1E1009

BE-8908, BE-8910, BE-8915, BE-8920, BE-8925, BE-8930		
--	--	--

Fit&Go 1/3 isolerade skruvmejslar för Phillips-skruv i skumplastinlägg 39 mm x 181 mm x 445 mm–6 delar

ergo®



FF1E1010

39 x 181 x 445 mm	1 FF1E1010

BE-8010S, BE-8230S, BE-8050S, BE-8255S		
BE-8610S, BE-8620S		

Fit&Go 1/3 skumplastinlägg med isolerade spår- och Phillips®-skruvmejslar, 45 x 181 x 445 mm – 6 delar

ergo®



FF1E1011

45 x 181 x 445 mm	1 FF1E1011

BE-8040S, BE-8050S, BE-8255S, BE-8065S		
BE-8610S, BE-8620S		



Fit&Go 1/3 skumplastinlägg med 1/4" hylsor och spärrhandtag med päronformat huvud – 37 delar



FF1E2001



38 x 181 x 445 mm



1 FF1E2001

6700SM-10, 6700SM-11, 6700SM-14, 6700SM-13, 6700SM-12, 6700SM-4, 6700SM-9, 6700SM-8, 6700SM-7, 6700SM-6, 6700SM-5.5, 6700SM-5

6700TORX-E10, 6700TORX-E8, 6700TORX-E7, 6700TORX-E6, 6700TORX-E5, 6700TORX-E4

6709M-8, 6709M-6, 6709M-5, 6709M-4, 6709M-3

6709TORX-T20, 6709TORX-T15, 6709TORX-T10, 6709TORX-T40, 6709TORX-T30, 6709TORX-T27, 6709TORX-T25, 6709TORX-T8, 6709TORX-T9

6950SL

6954

6956

6960

6966

Fit&Go 1/3 1/4" sats med hylsor och spärrhandtag i skumplastinlägg – 45 delar



FF1E2002



38 x 181 x 445 mm



1 FF1E2002

6700SM-4, 6700SM-4.5, 6700SM-5, 6700SM-5.5, 6700SM-6, 6700SM-7, 6700SM-8, 6700SM-9, 6700SM-10, 6700SM-11, 6700SM-12, 6700SM-13, 6700SM-14

6709PZ-1, 6709PZ-3, 6709PZ-2

6709PH-1, 6709PH-2, 6709PH-3

6709TORX-T10, 6709TORX-T15, 6709TORX-T20, 6709TORX-T25, 6709TORX-T30, 6709TORX-T40

6709F-4.5, 6709F-5.5, 6709F-8

6709M-3, 6709M-4, 6709M-5, 6709M-6, 6709M-8

1998M-3, 1998M-2.5, 1998M-2, 1998M-1.5

6950SL

6962-W

6966

6956

6960, 6961

7765

6954

Fit&Go 1/3 skumplastinlägg med insexnycklar, 1/4" hylsor och spärrhandtag med smalt huvud, samt tillbehör – 19 delar



FF1E2003



38 x 181 x 445 mm



1 FF1E2003

6700SM-14, 6700SM-13, 6700SM-12, 6700SM-11, 6700SM-10, 6700SM-9, 6700SM-8, 6700SM-7, 6700SM-6, 6700SM-5.5, 6700SM-5

BE-9778

6950SL

6956

6962

6966

7765

6954

1998M-12

Fit&Go 1/3 skumplastinlägg med bits, bitsskrumvjsel, 1/4" hylsor och spärrhandtag med smalt huvud samt tillbehör – 48 delar



FF1E2004



44 x 181 x 445 mm



1 FF1E2004

A6700DM-14, A6700DM-13, A6700DM-12, A6700DM-11, A6700DM-10, A6700DM-9, A6700DM-8, A6700DM-7, A6700DM-6, A6700DM-5.5, A6700DM-5

808050S

6950SL

6966

6972H

6962

7765

59S/31-1

Fit&Go 1/3 skumplastinlägg med 1/4" hylsor och spärrhandtag med runt huvud samt tillbehör – 17 delar



FF1E2005



35 x 181 x 445 mm



1 FF1E2005

6700SM-14, 6700SM-13, 6700SM-12, 6700SM-11, 6700SM-10, 6700SM-9, 6700SM-8, 6700SM-7, 6700SM-6, 6700SM-5.5

6950RN

6962, 6960

6966

6954

6956

6972H

Fit&Go 1/3 skumplastinlägg med 1/4" hylsor och spärrhandtag med runt huvud samt tillbehör – 35 delar



FF1E2006

39 x 181 x 445 mm 1 FF1E2006

6700SZ-5/16, 6700SZ-5/32, 6700SZ-11/32, 6700SZ-7/16, 6700SZ-9/32, 6700SZ-3/16, 6700SZ-3/8, 6700SZ-7/32, 6700SZ-1/4, 6700SZ-1/2, 6700SZ-9/16		
6709PZ-1, 6709PZ-2, 6709PZ-3		
6709PH-1, 6709PH-2, 6709PH-3		
6709TORX-T8, 6709TORX-T10, 6709TORX-T15, 6709TORX-T20, 6709TORX-T25, 6709TORX-T30		
6709F-4.5, 6709F-6.5, 6709F-8		
6950RN		
6954		
6972H		
6960, 6962		
6963		
6966		
6956		
7765		

Fit&Go 1/3 skumplastinlägg med insexnycklar, 1/4" hylsor och spärrhandtag med runt huvud samt tillbehör – 26 delar



FF1E2008

35 x 181 x 445 mm 1 FF1E2008

6700SM-5.5, 6700SM-8, 6700SM-7, 6700SM-6, 6700SM-12, 6700SM-11, 6700SM-10, 6700SM-9, 6700SM-14, 6700SM-13		
1995M-3, 1995M-2, 1995M-7, 1995M-6, 1995M-5, 1995M-4, 1995M-10, 1995M-9, 1995M-8		
6950RN		
6960, 6962		
6966		
6954		
6956		
6972H		

Fit&Go 1/3 skumplastinlägg med 3/8" hylsor och spärrhandtag med smalt huvud samt tillbehör – 24 delar



FF1E2101

40 x 181 x 445 mm 1 FF1E2101

7400SM-8, 7400SM-7, 7400SM-6, 7400SM-12, 7400SM-11, 7400SM-10, 7400SM-9, 7400SM-22, 7400SM-16, 7400SM-15, 7400SM-14, 7400SM-13, 7400SM-20, 7400SM-19, 7400SM-18, 7400SM-17		
7750SL		
7760, 7761, 7762		
7764		
7766		
7754		
8164-1/2		

Fit&Go 1/3 skumplastinlägg med insexnycklar, 1/4" hylsor och spärrhandtag med runt huvud samt tillbehör – 24 delar



FF1E2007

35 x 181 x 445 mm 1 FF1E2007

6700SZ-9/32, 6700SZ-3/16, 6700SZ-3/8, 6700SZ-1/4, 6700SZ-7/16, 6700SZ-7/32, 6700SZ-1/2, 6700SZ-11/32		
1995Z-5/64, 1995Z-5/32, 1995Z-3/8, 1995Z-3/32, 1995Z-7/32, 1995Z-1/8, 1995Z-5/16, 1995Z-3/16, 1995Z-1/4		
6950RN		
6954		
6972H		
6960, 6962		
6956		
6966		

Fit&Go 1/3 skumplastinlägg med 3/8" hylsor och spärrhandtag med smalt huvud samt tillbehör – 25 delar



FF1E2102

38 x 181 x 445 mm 1 FF1E2102

7400SM-8, 7400SM-7, 7400SM-6, 7400SM-12, 7400SM-11, 7400SM-10, 7400SM-9, 7400SM-16, 7400SM-15, 7400SM-14, 7400SM-13, 7400SM-19, 7400SM-18, 7400SM-17		
7409M-5, 7409M-4, 7409M-10, 7409M-8, 7409M-6		
7750SL		
7760, 7762		
7754		
7768		
8164-1/2		

Fit&Go 1/3 3/8" sats med hylsor och spärrhandtag i skumplastinlägg – 28 delar



FF1E2103

38 x 181 x 445 mm 1 FF1E2103

7400SM-8, 7400SM-7, 7400SM-12, 7400SM-11, 7400SM-10, 7400SM-9, 7400SM-22, 7400SM-21, 7400SM-16, 7400SM-15, 7400SM-14, 7400SM-13, 7400SM-20, 7400SM-19, 7400SM-18, 7400SM-17		
7400TORX-E10, 7400TORX-E8, 7400TORX-E18, 7400TORX-E16, 7400TORX-E14, 7400TORX-E12		
7750SL		
7760, 7762		
7768		
7766		
SBS705		



Bahco Fit&Go 1/3 skumplastinlägg med 3/8" hylsor och spärrhandtag med runt huvud samt tillbehör – 20 delar



FF1E2104



38 x 181 x 445 mm

1 FF1E2104

7400SM-8, 7400SM-6, 7400SM-12,
7400SM-11, 7400SM-10, 7400SM-9,
7400SM-22, 7400SM-16, 7400SM-15,
7400SM-14, 7400SM-13, 7400SM-20,
7400SM-19, 7400SM-18, 7400SM-17



7750RN



7761, 7762



7766



7768



Fit&Go 1/3 skumplastinlägg med 3/8" hylsor och bitshylsor – 28 delar



FF1E2105



35 x 181 x 445 mm

1 FF1E2105

7400TORX-E18, 7400TORX-E10,
7400TORX-E8, 7400TORX-E16,
7400TORX-E14, 7400TORX-E12,
7400TORX-E11



7409TORX-T50, 7409TORX-T45,
7409TORX-T40, 7409TORX-T30,
7409TORX-T25



7409TORX-T25-L, 7409TORX-T50-L,
7409TORX-T45-L, 7409TORX-T40-L,
7409TORX-T30-L



7409M-5, 7409M-4, 7409M-10,
7409M-8, 7409M-6



7409F-10, 7409F-8, 7409F-6.5



7409PH-3, 7409PH-2, 7409PH-1



Fit&Go 1/3, 1/2" sats med hylsor och spärrhandtag i skumplastinlägg – 21 delar



FF1E2201



44 x 181 x 445 mm

1 FF1E2201

7800SM-11, 7800SM-10, 7800SM-15,
7800SM-13, 7800SM-12, 7800SM-19,
7800SM-17, 7800SM-14, 7800SM-18,
7800SM-22, 7800SM-21, 7800SM-20,
7800SM-27, 7800SM-24



7805SM-16, 7805SM-21



8150SL



8160-5, 8160-10



8166



8171



Fit&Go 1/3 skumplastinlägg med 1/2" hylsor och spärrhandtag med päronformat huvud samt tillbehör – 21 delar



FF1E2202



45 x 181 x 445 mm

1 FF1E2202

7800SM-9, 7800SM-8, 7800SM-10,
7800SM-11, 7800SM-12, 7800SM-15,
7800SM-14, 7800SM-13, 7800SM-19,
7800SM-17, 7800SM-16, 7800SM-18,
7800SM-23, 7800SM-21, 7800SM-20,
7800SM-27, 7800SM-24



8150-1/2



8160-5, 8160-10



8166



Fit&Go 1/3 skumplastinlägg med 1/2" hylsor och spärrhandtag med runt huvud samt tillbehör – 22 delar



FF1E2203



50 x 181 x 445 mm

1 FF1E2203

7800SM-8, 7800SM-9, 7800SM-11,
7800SM-10, 7800SM-15, 7800SM-14,
7800SM-13, 7800SM-12, 7800SM-19,
7800SM-18, 7800SM-17, 7800SM-16,
7800SM-22, 7800SM-21, 7800SM-27,
7800SM-24, 7800SM-32, 7800SM-30



8150RN-1/2



8160-5, 8160-10



8166



Fit&Go 1/3 skumplastinlägg med 1/2" hylsor och spärrhandtag med runt huvud samt tillbehör – 15 delar



FF1E2204



45 x 181 x 445 mm

1 FF1E2204

7800DZ-1/2, 7800DZ-3/4, 7800DZ-19/32,
7800DZ-7/8, 7800DZ-7/16, 7800DZ-11/16,
7800DZ-9/16, 7800DZ-13/16, 7800DZ-3/8,
7800DZ-5/8, 7800DZ-15/16



8150RN-1/2



8160-5, 8160-10



8166



Fit&Go 1/3 skumplastinlägg med 1/2" hylsor och bitshylsor – 28 delar



FF1E2205



50 x 181 x 445 mm



1 FF1E2205



7800DM-10, 7800DM-11, 7800DM-12, 7800DM-13, 7800DM-14, 7800DM-15, 7800DM-16, 7800DM-17, 7800DM-18, 7800DM-19, 7800DM-20, 7800DM-21, 7800DM-22, 7800DM-23, 7800DM-24, 7800DM-25, 7800DM-26, 7800DM-27, 7800DM-28, 7800DM-30, 7800DM-32



7809M-6, 7809M-7, 7809M-8, 7809M-9, 7809M-10, 7809M-12, 7809M-14



Fit&Go 1/3 skumplastinlägg med 1/2" hylsor och bitshylsor – 27 delar



FF1E2206



50 x 181 x 445 mm



1 FF1E2206



7800SM-11, 7800SM-10, 7800SM-15, 7800SM-14, 7800SM-13, 7800SM-12, 7800SM-19, 7800SM-18, 7800SM-17, 7800SM-16, 7800SM-23, 7800SM-22, 7800SM-21, 7800SM-20, 7800SM-27, 7800SM-26, 7800SM-25, 7800SM-24, 7800SM-28, 7800SM-32, 7800SM-30



7809XZN-8, 7809XZN-10



7809PZ-3, 7809PZ-2



7809F-10, 7809F-8



Fit&Go 1/3 skumplastinlägg med insexnycklar, 1/2" hylsor och bitshylsor – 25 delar



FF1E2207



40 x 181 x 445 mm



1 FF1E2207



7809TORX-T60, 7809TORX-T55, 7809TORX-T25, 7809TORX-T20, 7809TORX-T40, 7809TORX-T30, 7809TORX-T27, 7809TORX-T50, 7809TORX-T45



7800TORX-E18, 7800TORX-E16, 7800TORX-E14, 7800TORX-E12, 7800TORX-E24, 7800TORX-E20, 7800TORX-E10, 7800TORX-E8



BE-9675



Fit&Go 1/3 skumplastinlägg med 1/2" bitshylsor – 12 delar



FF1E2208



35 x 181 x 445 mm



1 FF1E2208



7809M-9, 7809M-8, 7809M-6, 7809M-7, 7809M-17, 7809M-14, 7809M-12, 7809M-10



7809M-5-180, 7809M-6-140, 7809M-8-120, 7809M-10-140



Fit&Go 1/3, 1/2" bitshylsor i skumplastinlägg – 20 delar



FF1E2209



35 x 181 x 445 mm



1 FF1E2209



7809M-5, 7809M-8, 7809M-7, 7809M-6, 7809M-17, 7809M-14, 7809M-12, 7809M-10



7809TORX-T27, 7809TORX-T25, 7809TORX-T60, 7809TORX-T40, 7809TORX-T30, 7809TORX-T55, 7809TORX-T50, 7809TORX-T45



7809XZN-10, 7809XZN-12, 7809XZN-6, 7809XZN-8



Fit&Go 1/3 skumplastinlägg med 1/2" bitshylsor, hjulhylsor och hylsskruvmejslar – 14 delar



FF1E2210



38 x 181 x 445 mm



1 FF1E2210



7809M-5, 7809M-8, 7809M-7, 7809M-6, 7809M-19, 7809M-17, 7809M-14, 7809M-12, 7809M-10



BE-7606, BE-7607



BWSS12P319, BWSS12P321, BWSS12P317

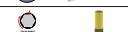

Fit&Go 1/3 skumplastinlägg med 1/2" kraftbitshylsor och krafthylsor – 21 delar



FF1E2211



50 x 181 x 445 mm

1 FF1E2211

7993S0050, 7993S0060, 7993S0080,
7993S0100, 7993S0120, 7993S0140,
7993S0170, 7993S0190



7994S0300, 7994S0400, 7994S0450,
7994S0500, 7994S0550, 7994S0600



K7801TORX-E10, K7801TORX-E12,
K7801TORX-E14, K7801TORX-E16,
K7801TORX-E18, K7801TORX-E20,
K7801TORX-E24



Fit&Go 1/3 skumplastinlägg med 1/2" krafthylssats – 12 delar



FF1E2212



40 x 181 x 445 mm

1 FF1E2212

K7801M-17, K7801M-18, K7801M-19,
K7801M-21, K7801M-22, K7801M-24,
K7801M-10, K7801M-12, K7801M-13,
K7801M-14, K7801M-15, K7801M-16



Fit&Go 1/3, 1/2" sats med långa krafthylsor i skumplastinlägg – 15 delar



FF1E2213



45 x 181 x 445 mm

1 FF1E2213

K7806M-13, K7806M-14, K7806M-16,
K7806M-17, K7806M-18, K7806M-19,
K7806M-21, K7806M-22, K7806M-24,
K7806M-27, K7806M-30, K7806M-32,
K7806M-10, K7806M-15, K7806M-12



Fit&Go 1/3 skumplastinlägg med 1/2" hylssats – 13 delar



FF1E2501



35 x 181 x 445 mm

1 FF1E2501

A7402DM-14, A7402DM-13,
A7402DM-12, A7402DM-11,
A7402DM-10



7805SM-16, 7805SM-15, 7805SM-14,
7805SM-13, 7805SM-19, 7805SM-18,
7805SM-17, 7805SM-12



Fit&Go 1/3 skumplastinlägg med 1/2" krafthylsor och tillbehör – 7 delar



FF1E2502



45 x 181 x 445 mm

1 FF1E2502

K560F-4, K560F-5



K8167S



K8160D-1, K8160D-2



K7764D



K8964D



Fit&Go 1/3 hylsor och skruvutdragare i skumplastinlägg – 35 delar



FF1E5005



36 x 181 x 445 mm

1 FF1E5005

BWTSP16



1418S



Fit&Go 1/3 skumplastinlägg med krafthylsor och torsionsstavar – 6 delar



FF1E5006



42 x 181 x 445 mm

1 FF1E5006

D/S14



BWSS12P3



BWTB12P120, BWTB12P110



Fit&Go 1/3 skumplastinlägg med oljeplugghylsor – 17 delar



FF1E5009



36 x 181 x 445 mm

1 FF1E5009

BE6217

Fit&Go 1/3 sats med dubbla u-nycklar i skumplastinlägg–8 delar



FF1E3001



47 x 181 x 445 mm

1 FF1E3001

6M-6-7, 6M-8-9, 6M-10-11, 6M-12-13, 6M-14-15, 6M-16-17, 6M-18-19, 6M-21-23, 6M-22-24

Fit&Go 1/3 skumplastinlägg med en sats dubbla u-nycklar – 3 delar



FF1E3002



35 x 181 x 445 mm

1 FF1E3002

6M-25-28, 6M-27-29, 6M-30-32

Fit&Go 1/3 skumplastinlägg med en sats dubbla u-nycklar – 9 delar



FF1E3003



41 x 181 x 445 mm

1 FF1E3003

6Z-1/2-9/16, 6Z-15/16-1, 6Z-5/16-11/32, 6Z-5/8-3/4, 6Z-3/8-7/16, 6Z-25/32-13/16, 6Z-19/32-11/16, 6Z-1/4-5/16, 6Z-3/4-7/8

Fit&Go 1/3 sats med spärrkombinycklar i skumplastinlägg–10 delar



FF1E3004



39 x 181 x 445 mm

1 FF1E3004

1RM-10, 1RM-9, 1RM-8, 1RM-14, 1RM-13, 1RM-12, 1RM-11, 1RM-17, 1RM-16, 1RM-15

Fit&Go 1/3 sats med spärrkombinycklar i skumplastinlägg–40 delar



FF1E3005



42 x 181 x 445 mm

1 FF1E3005

59S/31-1

6966

41RM-14, 41RM-13, 41RM-12, 41RM-10, 41RM-8, 41RM-19, 41RM-17

8166

Fit&Go 1/3 spärrnyckelsats i skumplastinlägg–8 delar



FF1E3006



35 x 181 x 445 mm

1 FF1E3006

1320RM-6-7, 1320RM-8-9, 1320RM-10-11, 1320RM-12-13, 1320RM-14-15, 1320RM-16-17, 1320RM-18-19, 1320RM-22-24

Fit&Go 1/3 sats med dubbla bockade ringnycklar, med skumplastinlägg–7 delar



FF1E3007



35 x 181 x 445 mm

1 FF1E3007

2M-6-7, 2M-8-9, 2M-10-11, 2M-12-13, 2M-14-15, 2M-16-17, 2M-18-19

Fit&Go 1/3 skumplastinlägg med dubbla rörhylsor – 9 delar



FF1E3008



50 x 181 x 445 mm

1 FF1E3008

27M-8-9, 27M-10-11, 27M-12-13, 27M-14-15, 27M-16-17, 27M-18-19, 27M-20-22, 27M-21-23, 27M-24-27



Fit&Go 1/3 tångsats i skumplastinlägg-4 delar



ergo



FF1E4001



35 x 181 x 445 mm

1 FF1E4001

2628 G-180IP

8231 IP

2430 G-200 IP

2101G-160IP



Fit&Go 1/3 sats med spårningstänger, med skumplastinlägg-4 delar



FF1E4002



35 x 181 x 445 mm

1 FF1E4002

2900-180

2890-180

2990-180

2800-180



Fit&Go 1/3 skumplastinlägg med skiftnyckel och tänger - 3 delar



ergo



FF1E5007



38 x 181 x 445 mm

1 FF1E5007

1410

9033

8225



Fit&Go 1/3 mätverktygssats i skumplastinlägg-7 delar



FF1E5001



45 x 181 x 445 mm

1 FF1E5001

MTB-5-25

8045LVDE

WR2-MM

1544

1178-SCRIBE

5515T

1150D



Fit&Go 1/3 skumplastinlägg med hammare, dornar och slagskrummejsel - 35 delar



FF1E5004



36 x 181 x 445 mm

1 FF1E5004

481-400

3734S/6

7865



Fit&Go 1/3 sats med hammare, huggmejslar, dorn i skumplastinlägg-11 delar



FF1E5002



35 x 181 x 445 mm

1 FF1E5002

3740-175, 3740-150, 3740-200

3734-5, 3734-4, 3734-3, 3734-2, 3734-8, 3734-6

481-100

1157



Fit&Go 1/3 skumplastinlägg med hammare, huggmejslar, kornare och dornar - 11 delar



FF1E5003



35 x 181 x 445 mm

1 FF1E5003

481-300

3735-5-120

3739-300

3740-125, 3740-100, 3740-150, 3740-200

3733-5, 3733-4, 3733-3, 3733-2



Fit&Go 1/3 skumplastinlägg med tändstiftshylsor och tänger - 4 delar



FF1E5008



37 x 181 x 445 mm

1 FF1E5008

7805ZZ-16, 7805ZZ-21

BE1P

BE61110



BAHCO

Fit&Go 1/3 sats med ERGO™ skruvmejselklingor i skumplastinlägg – 6 delar, hängförpackad



ergo™



FF1E1012EH



55 x 185 x 480 mm



1 FF1E1012EH

BE-8030		
BE-8150		
BE-8621, BE-8611		
BE-8811, BE-8821		

Fit&Go 1/3 Torx® skruvmejselsats T8–T30 i skumplastinlägg – 6 delar, hängförpackad



ergo™



FF1E1009EH



55 x 185 x 480 mm



1 FF1E1009EH

BE-8908, BE-8910, BE-8915, BE-8920, BE-8925, BE-8930		
--	--	--

Fit&Go 1/3 sats med ERGO™ skruvmejslar med genomgående klinga i skumplastinlägg – 6 delar, hängförpackad



ergo™



FF1E1013EH



55 x 1852 x 480 mm



1 FF1E1013EH

BE-8135TB, BE-8145TB, BE-8150TB, BE-8155TB		
BE-8810TB, BE-8820TB		

Fit&Go 1/3 sats med 1/4" hylsor och bitsats i skumplastinlägg – 46 delar, hängförpackad



FF1E2009EH



55 x 185 x 480 mm



1 FF1E2009EH

59/S31B-IP		
6700SM-4, 6700SM-4.5, 6700SM-5, 6700SM-5.5, 6700SM-6, 6700SM-7, 6700SM-8, 6700SM-9, 6700SM-10, 6700SM-11, 6700SM-12, 6700SM-13		
6962-W		
6972H		
6950SL		

Fit&Go 1/3 sats med 1/4" långa hylsor i skumplastinlägg – 11 delar, hängförpackad



FF1E2010EH



55 x 185 x 480 mm



1 FF1E2010EH

S0810L		
1419-MD		

Fit&Go 1/3 sats med 3/8" hylsor i skumplastinlägg – 18 delar, hängförpackad



FF1E2106EH



55 x 185 x 480 mm



1 FF1E2106EH

7400SM-10, 7400SM-11, 7400SM-12, 7400SM-13, 7400SM-14, 7400SM-15, 7400SM-16, 7400SM-17, 7400SM-18, 7400SM-19, 7400SM-20, 7400SM-22		
7760, 7761		
7766		
SBS750		
SBS71-16, SBS71-21		

Fit&Go 1/3 sats med 1/2" hylsor i skumplastinlägg – 21 delar, hängförpackad



FF1E2214EH



55 x 185 x 480 mm



1 FF1E2214EH

7800SM-10, 7800SM-11, 7800SM-12, 7800SM-13, 7800SM-14, 7800SM-15, 7800SM-16, 7800SM-17, 7800SM-18, 7800SM-19, 7800SM-20, 7800SM-21, 7800SM-22, 7800SM-23, 7800SM-24, 7800SM-27, 7800SM-30, 7800SM-32		
8150SL		
8174A		
8166		

Fit&Go 1/3 sats med 3/8" långa hylsor i skumplastinlägg – 14 delar, hängförpackad



FF1E2107EH



55 x 185 x 480 mm

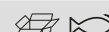

1 FF1E2107EH

SBA7402DM-11, SBA7402DM-10, SBA7402DM-13, SBA7402DM-12, SBA7402DM-7, SBA7402DM-9, SBA7402DM-8, SBA7402DM-19, SBA7402DM-18, SBA7402DM-15, SBA7402DM-14, SBA7402DM-17, SBA7402DM-16		
---	--	--



Fit&Go 1/3 sats med 1/2" långa hylsor i skumplastinlägg – 12 delar, hängförpackad



FF1E2215EH



55 x 185 x 480 mm

1 FF1E2215EH

S1612L



Fit&Go 1/3 bitssats i skumplastinlägg – 49 delar, hängförpackad



FF1E2503EH



55 x 185 x 480 mm

1 FF1E2503EH

BE5049



Fit&Go 1/3 sats med u-ringnycklar i skumplastinlägg, 11 delar, hängförpackad



FF1E3009EH



55 x 185 x 480 mm

1 FF1E3009EH

111M-8, 111M-10, 111M-11, 111M-12,
111M-13, 111M-14, 111M-15, 111M-16,
111M-17, 111M-18, 111M-19



Fit&Go 1/3 sats med 1RM-spärrkombinycklar – 5 delar, hängförpackad



FF1E3010EH



55 x 185 x 480 mm

1 FF1E3010EH

1RM-8, 1RM-10, 1RM-13, 1RM-17,
1RM-19



Fit&Go 1/3 sats med magnetisk skål och skiftnycklar i skumplastinlägg – 4 delar, hängförpackad



FF1E3011EH



55 x 185 x 480 mm

1 FF1E3011EH

8070 IP, 8071 IP, 8072 IP

1419-MD



Fit&Go 1/3 tångsats i skumplastinlägg – 3 delar, hängförpackad



FF1E4003EH



55 x 185 x 480 mm

1 FF1E4003EH

8224 IP

2101G-160IP

2430 G-160 IP



Fit&Go 1/3 sats med nittång och plåtsax i skumplastinlägg – 4 delar, hängförpackad



FF1E4004EH



55 x 185 x 480 mm

1 FF1E4004EH

2681

MA401

MA411

1178-SCRIBE



Fit&Go 1/3 sats med hammare, sprintutdrivare och slagskruvmejsel i skumplastinlägg – 23 delar, hängförpackad



FF1E5010EH



55 x 185 x 480 mm

1 FF1E5010EH

481-400

3734-2, 3734-3, 3734-4, 3734-5, 3734-6, 3734-8

3735-5-120

7865



Fit&Go 1/3 sats med spärringstänger i skumplastinlägg – 4 delar, hängförpackad



FF1E4005EH



55 x 185 x 480 mm

1 FF1E4005EH

2800-150, 2800-180

2900-150, 2900-180



Fit&Go 1/3 sats med sylar, krokar och knivar i skumplastinlägg – 11 delar, hängförpackad



FF1E5011EH



55 x 185 x 480 mm



1 FF1E5011EH

2633/S4, 2633L/S4

2489

2485

KE18-01

Fit&Go 1/3 sats med insexnycklar, bitsats och magnetisk skål i skumplastinlägg – 36 delar, hängförpackad



FF1E5013EH



55 x 185 x 480 mm



1 FF1E5013EH

BE-9770

2058/S26

1419-MD

Fit&Go 1/3 sats med 1/4" hylsor och tillbehör i skumplastinlägg – 25 delar, hängförpackad



FF1E2011EH



55 x 185 x 480 mm



1 FF1E2011EH

SL25

Fit&Go 1/3 sats med 1/2" spärrhandtag och tillbehör i skumplastinlägg – 24 delar, hängförpackad



FF1E2216EH



55 x 185 x 480 mm



1 FF1E2216EH

SBS81

Fit&Go 1/3 sats med 1/4" och 3/8" hylsor i skumplastinlägg – 33 delar, hängförpackad



FF1E2504EH



55 x 185 x 480 mm



1 FF1E2504EH

S330

Fit&Go 1/3 sats med 1/4" och 3/8" hylsor – 34 delar, hängförpackad



FF1E2505EH



55 x 185 x 480 mm



1 FF1E2505EH

S330AF

Fit&Go 1/3 sats med skiftnyckel, polygriptång och metallkapningsverktyg – 8 delar, hängförpackad



FF1E5014EH



55 x 185 x 480 mm



1 FF1E5014EH

9031P

8224

208

3906-300-24-5P

1/3 tomt skumplastinlägg med urtag och hängare



FF1E5016EH



35 x 181 x 445 mm



1 FF1E5016EH

Fit&Go 1/3 sats med ERGO™ filar – 4 delar, hängförpackad



ergo®



FF1E5015EH



55 x 185 x 480 mm



1 FF1E5015EH

1-100-08-2-2

1-210-08-2-2

4-138-08-1-2

4-272-05-3-2

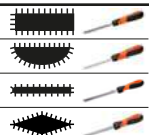

Fit&Go 2/3 skumplastinlägg med spårskruvmejslar – 8 delar



ergo



FF1F1001

Fit go



40 x 362 x 445 mm

1 FF1F1001

BE-8210, BE-8030, BE-8040, BE-8240,
BE-8242, BE-8252, BE-8250L



BE-8255, BE-8257



Fit&Go 2/3 skumplastinlägg med spår- och Phillips-skruvmejslar – 11 delar



ergo



FF1F1002

Fit go



40 x 362 x 445 mm

1 FF1F1002

BE-8020, BE-8040, BE-8242, BE-8252



BE-8330



BE-8256, BE-8258



BE-8610, BE-8620, BE-8623



BE-8602



Fit&Go 2/3 skruvmejslar för spår- och Phillips-skriv i skumplastinlägg – 11 delar



ergo



FF1F1003

Fit go



38 x 362 x 445 mm

1 FF1F1003

BE-8030, BE-8242, BE-8252



BE-8155



BE-8870



BE-8600, BE-8610, BE-8620, BE-8623,
BE-8624



808050TS



Fit&Go 2/3 skumplastinlägg med skruvmejslar för Torx®-skruv – 10 delar



ergo



FF1F1004

Fit go



38 x 362 x 445 mm

1 FF1F1004

BE-8904, BE-8907, BE-8908



BE-7910, BE-7915, BE-7920, BE-7925,
BE-7927, BE-7930, BE-7940



Fit&Go 2/3 skumplastinlägg med isolerade skruvmejslar för spår-, Phillips®- och Pozidriv®-skruv – 8 delar



ergo



FF1F1006

Fit go



40 x 362 x 445 mm

1 FF1F1006

BE-8230S, BE-8040S, BE-8050S,
BE-8255S



BE-8810S, BE-8820S



BE-8610S, BE-8620S



Fit&Go 2/3 skumplastinlägg med Torx®-skruvmejslar med t-handtag – 7 delar



Fit&Go 2/3 Skruvmejslar och bits Torx® i skumplastinlägg – 12 delar



FF1F1005

Fit go



43 x 362 x 445 mm

1 FF1F1005

BE-8908, BE-8909, BE-8910, BE-8915,
BE-8920, BE-8925, BE-8927, BE-8930



K6650-1/4-1P



808050S



808050



59S/31-3



FF1F1007

Fit go



35 x 362 x 445 mm

1 FF1F1007

901T-010-100, 901T-015-150, 901T-020-150,
901T-025-150, 901T-027-150, 901T-030-200,
901T-040-200



BAHCO

Fit&Go 2/3 skruvmejslar, insexnycklar, bits i skumplastinlägg-49 delar



FF1F1008



38 x 362 x 445 mm

1 FF1F1008

B219.026		
B705.1/4.125		
B146.006.100		
B145.006.100		
BE-9770		
59S/31-1		

Fit&Go 2/3 skumplastinlägg med skruvmejslar för spår-, Phillips®, Pozidriv® och Torx®-skruv - 14 delar



FF1F1009



38 x 362 x 445 mm

1 FF1F1009

B219.026		
B219.025		
B196.030.100		
B195.002.025		
B195.050.025		

Fit&Go 2/3 skumplastinlägg med insexnycklar, 1/4" hylsor och spärrhandtag med smalt huvud samt tillbehör - 44 delar



FF1F2001



37 x 362 x 445 mm

1 FF1F2001

A6800DM-11, A6800DM-10, A6800DM-9, A6800DM-8, A6800DM-13, A6800DM-12, A6800DM-4, A6800DM-7, A6800DM-6, A6800DM-5.5, A6800DM-5

6700SM-8, 6700SM-7, 6700SM-6, 6700SM-5.5, 6700SM-12, 6700SM-11, 6700SM-10, 6700SM-9, 6700SM-14, 6700SM-5, 6700SM-13

6709PH-2, 6709PH-1, 6709PH-3

6709PZ-2, 6709PZ-1

6709M-5, 6709M-4, 6709M-3, 6709M-8, 6709M-6

6709F-5.5, 6709F-4.5, 6709F-8

BE-9778

6950SL

7765

6954

6962

6966

6972H

6956

1998M-12

Fit&Go 2/3 hyls-/bitsatts med skumplastinlägg, magnetiskt hål-53 delar



FF1F2002



45 x 362 x 445 mm

1 FF1F2002

SL25L

2058/S26

6956

1419-MD

Fit&Go 2/3 skumplastinlägg med 3/8" hylsor och spärrhandtag med smalt huvud samt tillbehör - 36 delar



FF1F2101



37 x 362 x 445 mm

1 FF1F2101

7400SM-8, 7400SM-7, 7400SM-12, 7400SM-11, 7400SM-10, 7400SM-9, 7400SM-22, 7400SM-21, 7400SM-16, 7400SM-15, 7400SM-14, 7400SM-13, 7400SM-20, 7400SM-19, 7400SM-18, 7400SM-17

7409M-8, 7409M-4, 7409M-6, 7409M-10

A7402DM-13, A7402DM-12, A7402DM-11, A7402DM-10

A7410DZ-5/16, A7410DZ-7/16, A7410DZ-9/16, A7410DZ-3/8, A7410DZ-5/8

7750SL

7762

7754

7766

7764

8164-1/2

7756

Fit&Go 2/3 hylsor och tillbehör i skumplastinlägg-34 delar



FF1F2102



40 x 362 x 445 mm

1 FF1F2102

S330L



Fit&Go 2/3 skumplastinlägg med 3/8" hylsnyckelsats – 38 delar



FF1F2103



35 x 362 x 445 mm



1 FF1F2103



S380

Fit&Go 2/3 hylsor och tillbehör 1/2" i skumplastinlägg – 35 delar



FF1F2201



50 x 362 x 445 mm



1 FF1F2201



7800SM-13, 7800SM-12, 7800SM-19, 7800SM-18, 7800SM-10, 7800SM-17, 7800SM-22, 7800SM-21, 7800SM-20, 7800SM-27, 7800SM-24, 7800SM-32, 7800SM-30

7800DM-16, 7800DM-15, 7800DM-14, 7800DM-13, 7800DM-19, 7800DM-18, 7800DM-17, 7800DM-12, 7800DM-11, 7800DM-10

7809M-5, 7809M-6, 7809M-7, 7809M-8, 7809M-12, 7809M-10

8150SL

8160-5, 8160-10

8166

8154-11

8171

Fit&Go 2/3 skumplastinlägg med 1/2" hylsor och spärrhandtag med smalt huvud samt tillbehör – 24 delar



FF1F2202



50 x 362 x 445 mm



1 FF1F2202



S240

S81SL

Fit&Go 2/3 skumplastinlägg med bitsats och magnetisk skål – 50 delar



FF1F5004



35 x 362 x 445 mm



1 FF1F5004



BE5049

1419-MD

Fit&Go 2/3 skumplastinlägg med verktygssats för stötdämparservice – 39 delar



FF1F5013



35 x 362 x 445 mm



1 FF1F5013



BS1000

Fit&Go 2/3 skumplastinlägg med 1/2" standard och långa krafthylsor – 27 delar



FF1F2203



50 x 362 x 445 mm



1 FF1F2203



K7801M-17, K7801M-18, K7801M-19, K7801M-21, K7801M-22, K7801M-24, K7801M-10, K7801M-12, K7801M-13, K7801M-14, K7801M-15, K7801M-16

K7806M-13, K7806M-14, K7806M-16, K7806M-17, K7806M-18, K7806M-19, K7806M-21, K7806M-22, K7806M-24, K7806M-27, K7806M-30, K7806M-32, K7806M-10, K7806M-15, K7806M-12

Fit&Go 2/3 skumplastinlägg med dubbla u-nycklar – 11 delar



FF1F3001



40 x 362 x 445 mm



1 FF1F3001



6M-6-7, 6M-8-9, 6M-10-11, 6M-12-13, 6M-14-15, 6M-16-18, 6M-17-19, 6M-20-22, 6M-21-23, 6M-24-27, 6M-30-32

Fit&Go 2/3 sats med u-ringnycklar i skumplastinlägg – 18 delar



FF1F3002



41 x 362 x 445 mm



1 FF1F3002



111M-24, 111M-22, 111M-27, 111M-17,
111M-16, 111M-15, 111M-14, 111M-21,
111M-19, 111M-18, 111M-9, 111M-8,
111M-7, 111M-6, 111M-13, 111M-12,
111M-11, 111M-10



Fit&Go 2/3 skumplastinlägg med
u-ringnycklar – 30 delar



FF1F3003



40 x 362 x 445 mm



1 FF1F3003



111M-6, 111M-7, 111M-8, 111M-9,
111M-17, 111M-16, 111M-15, 111M-14,
111M-19, 111M-18, 111M-13, 111M-12,
111M-11, 111M-10, 111M-21, 111M-20,
111M-22



1320SRM-14-19

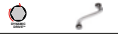

1RMA-19-1/4-SQ



1RMA-13-10-BIT



BE-9778



Fit&Go 3/3 skumplastinlägg med
u-ringnycklar i tum-dimensioner – 13 delar



FF1F3004



42 x 362 x 445 mm



1 FF1F3004



111Z-3/8, 111Z-11/16, 111Z-1, 111Z-1/2,
111Z-13/16, 111Z-5/16, 111Z-5/8,
111Z-15/16, 111Z-7/16, 111Z-3/4,
111Z-1/4, 111Z-9/16, 111Z-7/8



Fit&Go 2/3 sats med spärrkombinycklar i
skumplastinlägg–15 delar



FF1F3005



39 x 362 x 445 mm



1 FF1F3005



1RM-8, 1RM-19, 1RM-10, 1RM-14,
1RM-13, 1RM-12, 1RM-18, 1RM-17,
1RM-16, 1RM-15, 1RM-22, 1RM-21



1RMA-13-10-BIT



Fit&Go 2/3 skumplastinlägg med
spärrkombinyckelsats – 17 delar



FF1F3006



35 x 362 x 445 mm



1 FF1F3006



1RM-19, 1RM-24, 1RM-22, 1RM-21,
1RM-27, 1RM-30

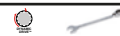

Fit&Go 2/3 skumplastinlägg med dubbla
bockade ringnycklar – 10 delar



FF1F3007



47 x 362 x 445 mm



1 FF1F3007



2M-6-7, 2M-8-9, 2M-10-11, 2M-12-13,
2M-14-15, 2M-16-18, 2M-17-19,
2M-21-23, 2M-24-27, 2M-30-32



Fit&Go 2/3 sats med ledhylsnycklar–9
delar



FF1F3008



38 x 362 x 445 mm



1 FF1F3008



4040M-6-7, 4040M-8-9, 4040M-10-11,
4040M-12-13, 4040M-14-15,
4040M-16-17, 4040M-18-19,
4040M-20-22, 4040M-21-23



Fit&Go 2/3 skumplastinlägg med öppna
ringnycklar – 8 delar



FF1F3009



35 x 362 x 445 mm



1 FF1F3009



1949M-8-9, 1949M-10-11,
1949M-12-13, 1949M-14-15,
1949M-17-19, 1949M-19-22,
1949M-24-27, 1949M-30-32



Fit&Go 2/3 skumplastinlägg med u-ringnycklar och spärringnycklar – 17 delar



FF1F3010



35 x 362 x 445 mm

1 FF1F3010

1RM/S5



111M/SH12



Fit&Go 2/3 skumplastinlägg med u-ringnycklar och spärringnycklar i metrisk dimensioner – 13 delar



FF1F3011



35 x 362 x 445 mm

1 FF1F3011

S4RM/3T



111M/SH12



Fit&Go 2/3 skiftnyckel och tänger i skumplastinlägg–8 delar



FF1F4001



35 x 362 x 445 mm

1 FF1F4001

2430 G-160 IP	
2421 G-180 IP	
2101G-160IP	
2628 G-200	
8224 IP	17
9029	
2951-140, 2951-300	

Fit&Go 2/3 sax och tänger i skumplastinlägg–8 delar



FF1F4002



35 x 362 x 445 mm

1 FF1F4002

2928-160	
2951-250	
SC127	
2101G-160IP	
2430 G-160 IP	
2339 DIP	
2628 G-180IP	
8224 IP	17

Fit&Go 2/3 skumplastinlägg med tänger – 4 delar



FF1F4003



35 x 362 x 445 mm

1 FF1F4003

2101G-160IP	
8224 IP	17
2951-180	
2430 G-200 IP	

Fit&Go 2/3 sats med spärringstänger i skumplastinlägg–8 delar



FF1F4004



35 x 362 x 445 mm

1 FF1F4004

2800-140, 2800-180		
2890-140, 2890-180		
2900-140, 2900-180		
2990-140, 2990-180		

Fit&Go 2/3 sats med isolerade tänger och polygrip–5 delar



FF1F4005



38 x 362 x 445 mm

1 FF1F4005

2101S-160	1000 V ECLASS
2430 S-200	1000 V ECLASS
2427 S-200	1000 V ECLASS
8224 IP	17
2628 S-180	1000 V ECLASS

Fit&Go 2/3 sats med filar, måttband, tänger i skumplastinlägg-10 delar



FF1F5001

40 x 362 x 445 mm	1	FF1F5001

1-100-08-1-2		
1-160-08-1-2		
1-170-08-1-2		
1-210-08-1-2		
1-230-08-1-2		
2430 G-200 IP		
2628G-200IP		
7224		
2101G-160IP		
MTB-3-16		

Fit&Go 2/3 sats med plåtsaxar, nittång, måttband i skumplastinlägg-5 delar



FF1F5002

38 x 362 x 445 mm	1	FF1F5002

2681	
MA401	
MA411	
1178-SCRIBE	
MTG-5-19	

Fit&Go 2/3 skiftnyckel, tänger i skumplastinlägg-5 delar



FF1F5003

35 x 362 x 445 mm	1	FF1F5003

8224	
2101G-160	
2430 G-160	
8071	
2951-250	

Fit&Go 2/3 skumplastinlägg med bågfilor och kniv - 8 delar



FF1F5005

40 x 362 x 445 mm	1	FF1F5005

317	
3906-300-24-5P	
268	
2446	

Fit&Go 2/3 sats med multimeter, avisoleringstång, crimptänger i skumplastinlägg-4 delar



FF1F5006

50 x 362 x 445 mm	1	FF1F5006

CR W 01	
CR B 05	
3418 A	
BMMTRMS1	

Fit&Go 2/3 skumplastinlägg med avdragare - 5 delar



FF1F5007

45 x 362 x 445 mm	1	FF1F5007

4543-1, 4543-2, 4543-3	
4545-2	
4541-A	

Fit&Go 2/3 sats med kniv, krokar, sylar i skumplastinlägg-11 delar



FF1F5008

37 x 362 x 445 mm	1	FF1F5008

2633/S4, 2633L/S4	
2489	
2485	
KE18-01	



Fit&Go 2/3 skumplastinlägg med avdragare – 5 delar



FF1F5009



60 x 362 x 445 mm



1 FF1F5009



BS618, BS623



4545-2



4545-N11



4532-0



Fit&Go 2/3 sats med blandade verktyg för auto i skumplastinlägg – 9 delar



FF1F5010



45 x 362 x 445 mm



1 FF1F5010



BBR6135



BBR6131



BBR110



1949M-8-9, 1949M-10-11



7809M-6, 7809M-8, 7809M-10



783



Fit&Go 2/3 skumplastinlägg med 1/2" mutterdragare – 7 delar



FF1F5011



100 x 362 x 445 mm



1 FF1F5011



BP815



BP821



BP822



BP823



Fit&Go 2/3 skumplastinlägg med 1/2" minimutterdragare – 9 delar



FF1F5012



55 x 362 x 445 mm



1 FF1F5012



BWSS12P317, BWSS12P319, BWSS12P321



BPC814



BWTB12P120



GL008-10



783



8157-15



Fit&Go 3/3 sats med skruvmejslar, bits och mätverktyg i skumplastinlägg – 66 delar



FF1A10



45 x 445 x 543 mm



1 FF1A10



BE-8020L, BE-8030



BE-8155



BE-8260



BE-8350



BE-8601, BE-8602



BE-8610, BE-8620



BE-8630



BE-8910, BE-8915, BE-8920, BE-8925, BE-8927, BE-8930, BE-8940



BE-9770



MTB-3-16



1150-1/2H/P



1177-SCRIBE



2820EF2



5515T-52



808050S



2047-0.8-4



2047PR-1-2

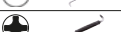

59S/31-1



Fit&Go 3/3 sats med skruvmejslar för spår-/Phillips-skruv, i skumplastinlägg – 14 delar



FF1A1001



45 x 445 x 543 mm



1 FF1A1001



2509



2535F1



BE-8040, BE-8210, BE-8230, BE-8252



BE-8255



BE-8350



BE-8628, BE-8629, BE-8630

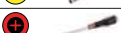

BE-8602



BE-8610L, BE-8620L



Fit&Go 3/3 sats med skruvmejslar för spår-, Phillips-, Pozidriv-skruv och insexnycklar i skumplastinlägg-27 delar



FF1A1002



40 x 445 x 543 mm



1 FF1A1002

BE-8210, BE-8030, BE-8040, BE-8242, BE-8252		
BE-8350		
BE-8257, BE-8258		
BE-8880		
BE-8602		
BE-8610, BE-8620		
BE-8630, BE-8640		
BE-8800, BE-8810, BE-8820		
BE-8802		
BE-9578		

Fit&Go 3/3 sats med skruvmejslar för spår-, Phillips-, Pozidriv-, Torx-skruv och insexnycklar i skumplastinlägg-34 delar



FF1A1003



40 x 445 x 543 mm



1 FF1A1003

BE-8158, BE-8159, BE-8870, BE-8880		
BE-8350		
BE-8610		
BE-8602		
BE-8630		
BE-8908, BE-8909, BE-8910, BE-8915, BE-8920, BE-8925, BE-8927, BE-8930, BE-8940		
BE-9575		
BE-9578		

Fit&Go 3/3 sats med skruvmejslar, vinkelskrvmejslar och bits i skumplastinlägg-66 delar



FF1A1005



43 x 445 x 543 mm



1 FF1A1005

59S/31-1		
BE-8020, BE-8240		
BE-8250, BE-8255		
BE-8865		
BE-8602		
BE-8611, BE-8621		
BE-9585		
BE-8630		
BE-8800, BE-8811, BE-8821		
BE-8802		
BE-8830		
BE-8910, BE-8915, BE-8920, BE-8925		
BE-9678		

Fit&Go 3/3 sats med skruvmejslar för spår-, Phillips-, Pozidriv-, Torx-skruv och insexnycklar i skumplastinlägg-29 delar



FF1A1006



40 x 445 x 543 mm



1 FF1A1006

BE-8030, BE-8040		
BE-8155		
BE-8350		
BE-8602		
BE-8611, BE-8621		
BE-8630		
BE-8906, BE-8907, BE-8908, BE-8909, BE-8910, BE-8915, BE-8920, BE-8925, BE-8930, BE-8940		
BE-9688		
BE-7606, BE-7607		

Fit&Go 3/3 sats med skruvmejslar, bits, insexnycklar, pincetter och spegel i skumplastinlägg-63 delar



FF1A1007



44 x 445 x 543 mm



1 FF1A1007

5468-112		
5471 F-145		
BE-8040, BE-8220		
BE-8158, BE-8159, BE-8865		
BE-8340		
BE-8601		
BE-8628, BE-8629		
BE-8906, BE-8907, BE-8908, BE-8909, BE-8910, BE-8915, BE-8920, BE-8925, BE-8930		
BE-9770		
TL 124-SA		
5515FL		

Fit&Go 3/3 sats med skruvmejslar, bits, insexnycklar, pincetter och spegel i skumplastinlägg-60 delar



FF1A1008



49 x 445 x 543 mm



1 FF1A1008

BE-8020L, BE-8040		
59S/31-1		
808050		
BE-8150, BE-8255, BE-8256		
BE-8340		
BE-8601		
BE-8610, BE-8620		
BE-8925, BE-8927, BE-8930, BE-8940, BE-8945		
BE-9678		



Fit&Go 3/3 skruvmejslar, bitsatts i skumplastinlägg-60 delar



FF1A17



50 x 445 x 543 mm



1 FF1A17

BE-8020L, BE-8220		
BE-8150, BE-8155		
BE-8260		
BE-8350		
BE-8601, BE-8602		
BE-8610, BE-8620		
BE-8630		
BE-9780		
2047-1-5.5		
2047PR-1-2		
2058-BR		
706-2		
808050		
59/S28-4		

Fit&Go 3/3 sats med skruvmejslar, insexnycklar, bits och kniv i skumplastinlägg-51 delar



FF1A21



48 x 445 x 543 mm



1 FF1A21

BE-8257, BE-8255		
BE-8242, BE-8040, BE-8030		
59S/31-1		
BE-8611, BE-8620		
BE-8910, BE-8915, BE-8920, BE-8925, BE-8927, BE-8930, BE-8940		
BE-9575		
BE-8577		
BE-8355		
BE-8602		
BE-9678		
2446		
7800SM-15		

Fit&Go 3/3 sats med skruvmejslar, insexnycklar och bits i skumplastinlägg-50 delar



FF1A27



45 x 445 x 543 mm



1 FF1A27

BE-8257, BE-8255		
BE-8242, BE-8040, BE-8030		
BE-8611, BE-8620		
59S/31-1		
BE-8910, BE-8915, BE-8920, BE-8925, BE-8927, BE-8930, BE-8940		
BE-9575		
BE-8577		
BE-8355		
BE-9678		
BE-8602		

Fit&Go 3/3 sats med skruvmejslar, bits och insexnycklar i skumplastinlägg-54 delar



FF1A40



45 x 445 x 543 mm



1 FF1A40

BE-8020, BE-8040		
BE-8150, BE-8155		
BE-8611, BE-8621		
BE-8811, BE-8821		
BE-8910, BE-8915, BE-8920, BE-8925, BE-8930		
904T-060-150		
BE-9770		
59S/31-1		

Fit&Go 3/3 måttband/skruvmejselsats med skumplastinlägg-20 delar



FF1A49



50 x 445 x 543 mm



1 FF1A49

808050P		
808050S		
6972H		
038.055.100, 038.065.125, 038.080.150		
039.001.100, 039.002.125		
59S/31-1		
BE-8040		
BE-8150, BE-8155		
BE-8010S, BE-8230S		
9045-B-250		
1150D		
426TOR9		
1179-FLX		
1178-SCRIBE		
MTS-5-25		

Fit&Go 3/3 sats med tänger och skruvmejslar i skumplastinlägg-19 delar



FF1A5001



40 x 445 x 543 mm



1 FF1A5001

2430 G-200 IP		
2101G-160IP		
2628 G-180IP		
2951-180		
7224		
BE-8150, BE-8155, BE-8256		
BE-8355		
BE-8611, BE-8620		
BE-8602		
BE-8910, BE-8915, BE-8920, BE-8925, BE-8930, BE-8940		
BE-9770		

Fit&Go 3/3 sats med ERGO™
skruvmejslar i skumplastinlägg-22 delar



ergo™



FF1A166



40 x 445 x 543 mm

1 FF1A166

9715-14-250		
BE-3529		
BE-8010, BE-8030		
BE-8150TB, BE-8256TB		
BE-8602		
BE-8611, BE-8621		
BE-8703, BE-8704, BE-8705, BE-8706, BE-8708		
BE-8811, BE-8821		
BE-8910, BE-8915, BE-8920, BE-8925, BE-8930		
BE-8986		

Fit&Go 3/3 sats med ERGO™
skruvmejslar, precisionsskruvmejslar och
insexnycklar i lasermärkt skumplastinlägg
- 37 delar



FF1A201LM



40 x 445 x 543 mm

1 FF1A201LM

BE-8256TB		
BE-8620TB, BE-8623TB		
700-2-50		
701-00-50, 701-0-50, 701-1-75		
703-10-50, 703-15-75, 703-6-50, 703-7-50, 703-8-50, 703-9-50		
BE-8040SL		
BE-8040		
BE-8150, BE-8155, BE-8256		
BE-8355		
BE-8600, BE-8611, BE-8621, BE-8623		
BE-8602		
BE-8811, BE-8821		
BE-8802		
BE-8870		
BE-9787		

Fit&Go 3/3 sats med skruvmejslar,
bits, 1/4", 1/2" hylsor och tillbehör i
skumplastinlägg-77 delar



FF1A01



45 x 445 x 543 mm

1 FF1A01

A6800DM-6, A6800DM-7, A6800DM-8, A6800DM-9, A6800DM-10, A6800DM-11, A6800DM-12, A6800DM-13, A6800DM-4, A6800DM-5		
6700SM-4.5, 6700SM-5, 6700SM-5.5, 6700SM-6, 6700SM-7, 6700SM-8, 6700SM-9, 6700SM-10, 6700SM-11, 6700SM-12, 6700SM-13, 6700SM-4		
59S/22-1		
6950SL		
6954		
6956		
6960, 6961		
6966		
6972H		
7800SM-18, 7800SM-19, 7800SM-10, 7800SM-11, 7800SM-12, 7800SM-13, 7800SM-14, 7800SM-15, 7800SM-16, 7800SM-17, 7800SM-22, 7800SM-27, 7800SM-24, 7800SM-30, 7800SM-32		
7805ZZ-21		
7807H		
B191.040.100, B191.055.150		
B192.001.100, B192.002.125		
8150SL		
8154-11		
8160-3, 8160-10		
8166		

Fit&Go 3/3 sats med 1/2" och 1/4"
spårskruvmejsel och bitsats i lasermärkt
skumplastinlägg.104 delar



FF1A051

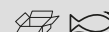

50 x 445 x 543 mm

1 FF1A051

BE-9678		
SBS60-5, SBS60-4.5, SBS60-6, SBS60-5.5, SBS60-4, SBS60-12, SBS60-11, SBS60-14, SBS60-13, SBS60-8, SBS60-7, SBS60-10, SBS60-9		
SBS61		
SBS63-2, SBS63-6, SBS63-4		
SBS65		
SBS67		
SBS69		
7800SM-22, 7800SM-24, 7800SM-19, 7800SM-18, 7800SM-21, 7800SM-32, 7800SM-30, 7800SM-27, 7800SM-15, 7800SM-14, 7800SM-17, 7800SM-16, 7800SM-11, 7800SM-10, 7800SM-13, 7800SM-12		
SBS88		
59S/31-1		
6956		
6972H		
7809M-5, 7809M-19, 7809M-6, 7809M-12, 7809M-17, 7809M-14, 7809M-10, 7809M-7, 7809M-8		
7809TORX-T60, 7809TORX-T50, 7809TORX-T55, 7809TORX-T40, 7809TORX-T45, 7809TORX-T25, 7809TORX-T20, 7809TORX-T30, 7809TORX-T27		
808050		
8150SL		
8154-11		
8160-W		
8160-10		
8166		
6954		



Fit&Go 3/3 1/4" + 1/2" + 3/8" sats med hylsor och tillbehör, spärrhandtag i skumplastinlägg-138 delar



FF1A08



60 x 445 x 543 mm



1 FF1A08

A6800DM-6, A6800DM-7, A6800DM-8, A6800DM-9, A6800DM-10, A6800DM-11, A6800DM-12, A6800DM-13, A6800DM-5.5

A7402DM-19, A7402DM-10, A7402DM-11, A7402DM-12, A7402DM-13, A7402DM-14, A7402DM-15, A7402DM-16, A7402DM-17, A7402DM-18

1544

2058-BR

6700SM-5.5, 6700SM-6, 6700SM-7, 6700SM-8, 6700SM-9, 6700SM-10, 6700SM-11, 6700SM-12, 6700SM-13

6709M-3, 6709M-4, 6709M-5, 6709M-6, 6709M-8

6709PH-1, 6709PH-2, 6709PH-3

6709TORX-T20, 6709TORX-T25, 6709TORX-T27, 6709TORX-T30, 6709TORX-T40, 6709TORX-T8, 6709TORX-T9, 6709TORX-T10, 6709TORX-T15

6950SL

6954

6956

6958

6960, 6961, 6962, 6962L

6966

6972H

7400SM-6, 7400SM-7, 7400SM-8, 7400SM-9, 7400SM-10, 7400SM-11, 7400SM-12, 7400SM-13, 7400SM-14, 7400SM-15, 7400SM-16, 7400SM-17, 7400SM-18, 7400SM-19, 7400SM-22

7407H

7409M-8, 7409M-10, 7409M-3, 7409M-4, 7409M-5, 7409M-6, 7409M-7

7409TORX-T25, 7409TORX-T27, 7409TORX-T30, 7409TORX-T40, 7409TORX-T45, 7409TORX-T50

7750SL

7754

7758

7760, 7761, 7762

7764

7765

7766

7800SM-18, 7800SM-19, 7800SM-21, 7800SM-22, 7800SM-24, 7800SM-27, 7800SM-30, 7800SM-32, 7800SM-10, 7800SM-11, 7800SM-12, 7800SM-13, 7800SM-14, 7800SM-15, 7800SM-16, 7800SM-17

7807H

7809M-12, 7809M-14, 7809M-17, 7809M-19, 7809M-5, 7809M-6, 7809M-7, 7809M-8, 7809M-10

7809TORX-T50, 7809TORX-T55, 7809TORX-T60, 7809TORX-T20, 7809TORX-T25, 7809TORX-T27, 7809TORX-T30, 7809TORX-T40, 7809TORX-T45

8150SL

8164-1/2

8154-11

8160-5, 8160-10

8171

8166

8172

Fit&Go 3/3 sats med fasta nycklar, hylsor och tillbehör i skumplastinlägg-93 delar



FF1A106



55 x 543 x 445 mm



1 FF1A106

S87+7

Fit&Go 3/3 sats med 1/4" + 3/8" hylsnycklar och päronformade spärrhuvuden, med skumplastinlägg-83 delar



FF1A13



55 x 445 x 543 mm



1 FF1A13

A6700DZ-1/2, A6700DZ-1/4, A6700DZ-11/32, A6700DZ-3/16, A6700DZ-3/8, A6700DZ-5/16, A6700DZ-7/16, A6700DZ-7/32, A6700DZ-9/16, A6700DZ-9/32

A6710DZ-1/2, A6710DZ-1/4, A6710DZ-11/32, A6710DZ-3/16, A6710DZ-3/8, A6710DZ-5/16, A6710DZ-7/16, A6710DZ-7/32, A6710DZ-9/16, A6710DZ-9/32

A6800DM-10, A6800DM-4

A6800DZ-1/2, A6800DZ-1/4, A6800DZ-11/32, A6800DZ-3/16, A6800DZ-3/8, A6800DZ-5/16, A6800DZ-7/16, A6800DZ-7/32, A6800DZ-9/16, A6800DZ-9/32

A7400DZ-1/2, A7400DZ-1/4, A7400DZ-11/16, A7400DZ-13/16, A7400DZ-17/32, A7400DZ-19/32, A7400DZ-3/4, A7400DZ-3/8, A7400DZ-5/8, A7400DZ-5/16, A7400DZ-7/8, A7400DZ-9/16

A7402DZ-1/2, A7402DZ-1/4, A7402DZ-11/16, A7402DZ-13/16, A7402DZ-19/32, A7402DZ-3/4, A7402DZ-3/8, A7402DZ-5/16, A7402DZ-5/8, A7402DZ-7/16, A7402DZ-7/8, A7402DZ-9/16

6700SZ-5/32

6950SL

6954

6956

6958

6960, 6961, 6962, 6962L

6966

6972H

7407H, 7408H

7750SL

7752

7754

7758

7760, 7761, 7762

7764

7765

7766

8164-1/2

8171

Fit&Go 3/3 sats med hylsor och tillbehör i skumplastinlägg-53 delar



FF1A130



45 x 445 x 543 mm



1 FF1A130

7800SM-18, 7800SM-19, 7800SM-21, 7800SM-22, 7800SM-23, 7800SM-24, 7800SM-27, 7800SM-30, 7800SM-32, 7800SM-8, 7800SM-9, 7800SM-10, 7800SM-11, 7800SM-12, 7800SM-13, 7800SM-14, 7800SM-15, 7800SM-16, 7800SM-17

8150SL	
SBS87S, SBS87	
SBS83-3, SBS83-5, SBS83-10	
SBS85	
SBS86	
SBS88	
SBS89	
7809TORX-T50, 7809TORX-T55, 7809TORX-T60, 7809TORX-T20, 7809TORX-T25, 7809TORX-T27, 7809TORX-T30, 7809TORX-T40, 7809TORX-T45	
7809M-14, 7809M-17, 7809M-19, 7809M-5, 7809M-6, 7809M-7, 7809M-8, 7809M-9, 7809M-10, 7809M-12	
7809M-5-180, 7809M-6-140, 7809M-7-100, 7809M-8-120, 7809M-10-140	

Fit&Go 3/3 sats med 1/4" och 1/2" hylsor och tillbehör i skumplastinlägg-59 delar



FF1A137

50 x 445 x 543 mm	1 FF1A137

7800SM-18, 7800SM-19, 7800SM-21, 7800SM-22, 7800SM-23, 7800SM-24, 7800SM-27, 7800SM-30, 7800SM-32, 7800SM-8, 7800SM-9, 7800SM-10, 7800SM-11, 7800SM-12, 7800SM-13, 7800SM-14, 7800SM-15, 7800SM-16, 7800SM-17	
---	--

8150SL	
SBS87S, SBS87	
SBS83-3, SBS83-5, SBS83-10	
SBS85	
SBS86	
SBS88	
SBS89	

7809TORX-T50, 7809TORX-T55, 7809TORX-T60, 7809TORX-T20, 7809TORX-T25, 7809TORX-T27, 7809TORX-T30, 7809TORX-T40, 7809TORX-T45	
--	--

6700SM-4.5, 6700SM-5, 6700SM-5.5, 6700SM-6, 6700SM-7, 6700SM-8, 6700SM-9, 6700SM-10, 6700SM-11, 6700SM-12, 6700SM-13, 6700SM-14, 6700SM-4	
---	--

6950SL	
SBS67	

SBS69	
SBS65	

SBS63-2, SBS63-4, SBS63-6	
6954	

Fit&Go 3/3 sats med hylsor och tillbehör, insexnycklar, bits etc i skumplastinlägg-71 delar



FF1A142

50 x 445 x 543 mm	1 FF1A142

7800SM-18, 7800SM-19, 7800SM-21, 7800SM-22, 7800SM-23, 7800SM-24, 7800SM-27, 7800SM-30, 7800SM-32, 7800SM-8, 7800SM-9, 7800SM-10, 7800SM-11, 7800SM-12, 7800SM-13, 7800SM-14, 7800SM-15, 7800SM-16, 7800SM-17	
---	--

8150SL	
BE-9678	

SBS87S, SBS87	
1547	

1150D	
59S/31-1	

8160-10, 8160-3, 8160-5	
8166	

8154-11	
8171	

8172	
------	--

Fit&Go 3/3 sats med 1/2" hylsor och tillbehör, tänger i skumplastinlägg-34 delar



FF1A146

50 x 445 x 543 mm	1 FF1A146

2628 G-180	
2430 G-160	

8224	
2101G-160	

FS-8	
------	--

7800SM-18, 7800SM-19, 7800SM-21, 7800SM-22, 7800SM-23, 7800SM-24, 7800SM-27, 7800SM-30, 7800SM-32, 7800SM-8, 7800SM-9, 7800SM-10, 7800SM-11, 7800SM-12, 7800SM-13, 7800SM-14, 7800SM-15, 7800SM-16, 7800SM-17	
---	--

8150SL	
SBS87S, SBS87	

8160-10, 8160-3, 8160-5	
8166	

8154-11	
8171	

8172	
------	--

Fit&Go 3/3 sats med 1/4", 1/2" hylsor och tillbehör och avdragare i skumplastinlägg-58 delar



FF1A22

50 x 445 x 543 mm	1 FF1A22

7800SM-18, 7800SM-19, 7800SM-21, 7800SM-22, 7800SM-23, 7800SM-24, 7800SM-27, 7800SM-30, 7800SM-32, 7800SM-10, 7800SM-12, 7800SM-13, 7800SM-14, 7800SM-16, 7800SM-17	
---	--

7805SM-27, 7805SM-13, 7805SM-30, 7805SM-16, 7805SM-32, 7805SM-17, 7805SM-18, 7805SM-19, 7805SM-21, 7805SM-22, 7805SM-24	
---	--

7809M-12, 7809M-14, 7809M-8, 7809M-5, 7809M-10, 7809M-6	
---	--

8150SL	
6700SM-4.5, 6700SM-5, 6700SM-5.5, 6700SM-6, 6700SM-7, 6700SM-8, 6700SM-9, 6700SM-10, 6700SM-11, 6700SM-12, 6700SM-13, 6700SM-4	

6958	
6954	

6960, 6962	
6966	

6950SL	
4532-A	

8157-15	
8154-11	

8160-3, 8160-5	
8166	



Fit&Go 3/3 sats med 3/4" hylsor och tillbehör i skumplastinlägg-26 delar



FF1A2301



70 x 445 x 543 mm

1 FF1A2301

8900DM-19, 8900DM-26, 8900DM-25, 8900DM-24, 8900DM-23, 8900DM-29, 8900DM-28, 8900DM-27, 8900DM-22, 8900DM-34, 8900DM-33, 8900DM-32, 8900DM-30, 8900DM-36, 8900DM-41, 8900DM-46, 8900DM-55, 8900DM-50, 8900DM-60

8954

8954A

8958A

8961

8965

8966

8955N/B

Fit&Go 3/3 sats med 1/4", 1/2" hylsor och tillbehör samt en griptång i skumplastinlägg-50 delar



FF1A25



50 x 445 x 543 mm

1 FF1A25

7800SM-18, 7800SM-19, 7800SM-21, 7800SM-22, 7800SM-23, 7800SM-24, 7800SM-27, 7800SM-30, 7800SM-32, 7800SM-10, 7800SM-12, 7800SM-13, 7800SM-14, 7800SM-15, 7800SM-16, 7800SM-17

7805SM-27, 7805SM-13, 7805SM-30, 7805SM-32, 7805SM-16, 7805SM-17, 7805SM-18, 7805SM-19, 7805SM-21, 7805SM-22, 7805SM-24

8150SL

6700SM-4.5, 6700SM-5, 6700SM-5.5, 6700SM-6, 6700SM-7, 6700SM-8, 6700SM-9, 6700SM-10, 6700SM-11, 6700SM-12, 6700SM-13, 6700SM-4

6954

6960, 6962

6966

6950SL

2953-250

8166

8154-11

8160-3, 8160-5

Fit&Go 3/3 sats med 1/4", 1/2", 3/8" hylsor och tillbehör i skumplastinlägg-83 delar



FF1A2501

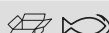

50 x 445 x 543 mm

1 FF1A2501

6700SM-8, 6700SM-7, 6700SM-6, 6700SM-5.5, 6700SM-12, 6700SM-11, 6700SM-10, 6700SM-9, 6700SM-13, 6700SM-5, 6700SM-4

6700TORX-E10, 6700TORX-E8

6709M-5, 6709M-4, 6709M-3, 6709M-8, 6709M-6

6709TORX-T40, 6709TORX-T30, 6709TORX-T27, 6709TORX-T8, 6709TORX-T25, 6709TORX-T20, 6709TORX-T15, 6709TORX-T10

6950SL

6954

6956

6962

6966

7400SM-8, 7400SM-12, 7400SM-11, 7400SM-10, 7400SM-9, 7400SM-22, 7400SM-21, 7400SM-16, 7400SM-15, 7400SM-14, 7400SM-13, 7400SM-20, 7400SM-19, 7400SM-18, 7400SM-17

7400TORX-E10, 7400TORX-E8, 7400TORX-E14, 7400TORX-E12

7750SL

7754

7762

7764

7765

7766

7768

7800SM-17, 7800SM-13, 7800SM-12, 7800SM-19, 7800SM-18, 7800SM-27, 7800SM-20, 7800SM-32, 7800SM-30, 7800SM-21, 7800SM-22, 7800SM-24

7809M-10, 7809M-12

7809TORX-T40, 7809TORX-T55, 7809TORX-T25, 7809TORX-T50, 7809TORX-T20

8150SL

8164-1/2

8154-11

8160-10

8171

8166

8172

Fit&Go 3/3 sats med 1/2"-3/8" hylsor och tillbehör i skumplastinlägg-101 delar



FF1A2503



55 x 445 x 543 mm

1 FF1A2503

6700SM-4.5, 6700SM-5, 6700SM-5.5, 6700SM-6, 6700SM-7, 6700SM-8, 6700SM-9, 6700SM-10, 6700SM-11, 6700SM-12, 6700SM-13, 6700SM-14, 6700SM-4

7800SM-18, 7800SM-19, 7800SM-21, 7800SM-22, 7800SM-23, 7800SM-24, 7800SM-26, 7800SM-27, 7800SM-28, 7800SM-30, 7800SM-32, 7800SM-10, 7800SM-11, 7800SM-12, 7800SM-13, 7800SM-14, 7800SM-15, 7800SM-16, 7800SM-17, 7800SM-8, 7800SM-9

BE-9678

7809M-10, 7809M-12, 7809M-14, 7809M-17, 7809M-19, 7809M-5, 7809M-7, 7809M-8, 7809M-9, 7809M-6

59S/31-1

7809M-10-140, 7809M-5-180, 7809M-6-140, 7809M-7-100, 7809M-8-120

808050

8155-1/2

6950

6954

6956

6960, 6962

6966

8154-11

8160-5, 8160-10

8166

Fit&Go 3/3 sats med hylsor och tillbehör, fasta nycklar, tänger etc i skumplastinlägg-46 delar



FF1A37

35 x 445 x 543 mm 1 FF1A37

111M-6, 111M-7, 111M-8, 111M-9, 111M-10, 111M-11, 111M-12, 111M-13, 111M-14, 111M-15, 111M-16, 111M-17, 111M-18, 111M-19, 111M-21, 111M-22, 111M-24	
8071 IP	
2101G-160	
2430 G-160	
8224	
8150SL	

Fit&Go 3/3 sats med fasta nycklar, hylsor och tillbehör i skumplastinlägg-54 delar



FF1A39

45 x 445 x 543 mm 1 FF1A39

S410	
S1612L	
8071 IP	

Fit&Go 3/3 sats med 1/4" + 3/8" hylsor och tillbehör, u-ringnycklar-91 delar



FF1A5003

45 x 445 x 543 mm 1 FF1A5003

111M-13, 111M-12, 111M-10, 111M-8, 111M-19, 111M-17, 111M-15	
6700SM-5.5, 6700SM-5, 6700SM-14, 6700SM-13, 6700SM-12, 6700SM-11, 6700SM-10, 6700SM-9, 6700SM-8, 6700SM-7, 6700SM-6	
6700TORX-E5, 6700TORX-E4, 6700TORX-E10, 6700TORX-E8, 6700TORX-E7, 6700TORX-E6	
6709TORX-T27, 6709TORX-T25, 6709TORX-T20, 6709TORX-T15, 6709TORX-T10, 6709TORX-T9, 6709TORX-T8, 6709TORX-T40, 6709TORX-T30	
6950	
6961, 6962	
6966	
7400SM-13, 7400SM-12, 7400SM-11, 7400SM-10, 7400SM-9, 7400SM-8, 7400SM-21, 7400SM-19, 7400SM-18, 7400SM-17, 7400SM-16, 7400SM-15, 7400SM-14, 7400SM-22	
7400TORX-E18, 7400TORX-E16, 7400TORX-E14, 7400TORX-E12, 7400TORX-E11, 7400TORX-E10, 7400TORX-E8	
7409TORX-T30, 7409TORX-T27, 7409TORX-T25, 7409TORX-T50, 7409TORX-T45, 7409TORX-T40	
7750	
7760, 7761, 7762	
7764	
7765	
7766	
A6800DM-8, A6800DM-7, A6800DM-6, A6800DM-14, A6800DM-13, A6800DM-12, A6800DM-11, A6800DM-10, A6800DM-9	
A7402DM-19, A7402DM-18, A7402DM-17, A7402DM-16, A7402DM-15, A7402DM-14, A7402DM-13, A7402DM-12, A7402DM-11, A7402DM-10	
8157-15	

Fit&Go 3/3 sats med nycklar/hylsnycklar med skumplastinlägg-38 delar



FF1A5004

55 x 445 x 543 mm 1 FF1A5004

1RM-19, 1RM-13, 1RM-12, 1RM-11, 1RM-10, 1RM-9, 1RM-8, 1RM-27, 1RM-7, 1RM-24, 1RM-6, 1RM-22, 1RM-17	
6700SM-13, 6700SM-12, 6700SM-11, 6700SM-10, 6700SM-9, 6700SM-8, 6700SM-7, 6700SM-6	
6950	

6960	
6966	
7800SM-19, 7800SM-17, 7800SM-32, 7800SM-30, 7800SM-13, 7800SM-27, 7800SM-24, 7800SM-22	
8155-1/2	
SBS86	
6954	
8160-5	
8166	

Fit&Go 3/3 hylsor och tillbehör, u-ringnycklar i skumplastinlägg-83 delar



FF1A5005

50 x 445 x 543 mm 1 FF1A5005

111M-17, 111M-15, 111M-13, 111M-19, 111M-8	
6700SM-8, 6700SM-7, 6700SM-6, 6700SM-12, 6700SM-11, 6700SM-10, 6700SM-9, 6700SM-14, 6700SM-13, 6700SM-5, 6700SM-4	
6709M-5, 6709M-4, 6709M-8, 6709M-6, 6709M-3	
6950SL	
6962	
6968	
7400SM-8, 7400SM-7, 7400SM-6, 7400SM-12, 7400SM-11, 7400SM-10, 7400SM-9, 7400SM-16, 7400SM-15, 7400SM-14, 7400SM-13, 7400SM-18, 7400SM-17	
7750SL	
7760-W	
7761	
7768	
7800SM-11, 7800SM-10, 7800SM-15, 7800SM-14, 7800SM-13, 7800SM-12, 7800SM-19, 7800SM-18, 7800SM-17, 7800SM-16, 7800SM-22, 7800SM-21, 7800SM-27, 7800SM-24, 7800SM-32, 7800SM-30, 7800SM-8, 7800SM-9	
7809M-17, 7809M-14, 7809M-12, 7809M-10, 7809M-5, 7809M-6, 7809M-7, 7809M-8	
7809TORX-T40, 7809TORX-T30, 7809TORX-T25, 7809TORX-T20, 7809TORX-T45	
8150SL	
A6709M-6, A6709M-5, A6709M-4, A6709M-3, A6709M-2.5	
K6650-1/4-1P	
6960W-2, 6960W-6	
8160-5, 8160-10	
8166	



Fit&Go 3/3 sats med hylsor och tillbehör, fasta nycklar i skumplastinlägg-41 delar



FF1A5013



50 x 445 x 543 mm

1 FF1A5013

111M-6, 111M-7, 111M-8, 111M-9, 111M-12, 111M-13, 111M-17, 111M-10, 111M-11, 111M-19, 111M-20, 111M-22, 111M-24, 111M-27, 111M-32, 111M-30

6700SM-6, 6700SM-7, 6700SM-8, 6700SM-9, 6700SM-10, 6700SM-11, 6700SM-12, 6700SM-13, 6700SM-14

6950

6960

6966

7800SM-19, 7800SM-17, 7800SM-13, 7800SM-22, 7800SM-27, 7800SM-24, 7800SM-30, 7800SM-32

8155-1/2

SBS86

6954

8160-5

8166

Fit&Go 3/3 sats med hylsor och tillbehör 1/4", 3/8" och 1/2" i skumplastinlägg-75 delar



FF1A5032



55 x 445 x 543 mm

1 FF1A5032

6700SM-10, 6700SM-11, 6700SM-8, 6700SM-9, 6700SM-14, 6700SM-12, 6700SM-13, 6700SM-4, 6700SM-6, 6700SM-7, 6700SM-5, 6700SM-4.5, 6700SM-5.5

6950

6954

6956

6960, 6962

6966

7400SM-6, 7400SM-7, 7400SM-10, 7400SM-11, 7400SM-8, 7400SM-9, 7400SM-14, 7400SM-15, 7400SM-12, 7400SM-13, 7400SM-18, 7400SM-19, 7400SM-16, 7400SM-17, 7400SM-22, 7400SM-20, 7400SM-21

7754

7755-3/8

7760, 7761, 7762

7766

7800DM-11, 7800DM-14, 7800DM-15, 7800DM-12, 7800DM-13, 7800DM-18, 7800DM-19, 7800DM-16, 7800DM-17, 7800DM-22, 7800DM-23, 7800DM-20, 7800DM-21, 7800DM-26, 7800DM-27, 7800DM-24, 7800DM-30, 7800DM-32, 7800DM-28, 7800DM-8, 7800DM-9, 7800DM-10, 7800DM-25, 7800DM-29

8155-1/2

111M-19, 111M-17, 111M-18, 111M-15, 111M-16, 111M-14, 111M-20

8154-11

8160-5, 8160-10

8166

Fit&Go 3/3 sats med 1/4", 1/2" hylsor och tillbehör, insexnycklar, bitskruvmejsel och bits i skumplastinlägg-75 delar



FF1A55



40 x 445 x 543 mm

1 FF1A55

A6700DZ-1/2, A6700DZ-1/4, A6700DZ-11/32, A6700DZ-3/16, A6700DZ-3/8, A6700DZ-5/16, A6700DZ-7/16, A6700DZ-7/32, A6700DZ-9/16, A6700DZ-9/32

BE-9775

SBS61

SBS63-2, SBS63-6, SBS63-4

SBS65

SBS67

SBS81

6956

6972H

7800DZ-1, 7800DZ-1/2, 7800DZ-11/16, 7800DZ-13/16, 7800DZ-15/16, 7800DZ-19/32, 7800DZ-3/4, 7800DZ-3/8, 7800DZ-5/8, 7800DZ-7/8, 7800DZ-9/16, 7800DZ-7/16

808050

6954

8160-10, 8160-5

8166

8154-11

Fit&Go 3/3 skumplastinlägg med bits- och hylssats - 105 delar



FF1A70



42 x 445 x 543 mm

1 FF1A70

BE5049

S560

Fit&Go 3/3 sats med hylsor och tillbehör 1/4" och 3/8" i skumplastinlägg-75 delar



FF1A54



35 x 445 x 543 mm

1 FF1A54

S1612L

S0810L

S330L

Fit&Go 3/3 sats med 1/4" och 1/2" hylsor och tillbehör, nycklar och tänger i skumplastinlägg - 94 delar



FF1A153



335 x 445 x 543 mm

1 FF1A153

S87+7

Fit&Go 3/3 sats med 1/2" och 3/8" hylsor och bitssats i skumplastinlägg – 177 delar



FF1A165

40 x 445 x 543 mm 1 FF1A165

BE5049	
S1214L	
S1612L	
SBS71-16	
SBS87	

Fit&Go 3/3 sats med 1/2" och 1/4" hylsor och bitssats i lasermärkt skumplastinlägg – 139 delar



FF1A195LM

40 x 445 x 543 mm 1 FF1A195LM

A6800DZ-9/16, A6800DZ-1/2, A6800DZ-1/4, A6800DZ-11/32, A6800DZ-3/16, A6800DZ-3/8, A6800DZ-5/16, A6800DZ-7/16, A6800DZ-7/32, A6800DZ-9/32	
K6625-1/4-1P	
K6650-1/4-1P, K6650-3/8-1P	
6954	
6963	
7767	
8167	
2058-BR	
59/S31B	
SL25L	
S330L	

Fit&Go 3/3 sats med 1/2" och 1/4" hylsnyckelsats och momentnyckel i lasermärkt skumplastinlägg – 51 delar



FF1A194

40 x 445 x 543 mm 1 FF1A194

6968	
6700SM-14, 6700SM-13, 6700SM-12, 6700SM-11, 6700SM-10, 6700SM-9, 6700SM-8, 6700SM-7, 6700SM-6, 6700SM-5, 6700SM-4	
6709M-3, 6709M-8, 6709M-6, 6709M-5, 6709M-4	
6950SL	
7800SM-24, 7800SM-23, 7800SM-22, 7800SM-13, 7800SM-12, 7800SM-11, 7800SM-10, 7800SM-9, 7800SM-8, 7800SM-21, 7800SM-19, 7800SM-18, 7800SM-17, 7800SM-16, 7800SM-15, 7800SM-14	
7809M-8, 7809M-7, 7809M-10, 7809M-6, 7809M-5	
7809TORX-T20, 7809TORX-T25, 7809TORX-T30, 7809TORX-T40	
7455-200	
8150SL	
8168	
K6650-1/4-1P	
6960W-2, 6960W-6	
8160-10, 8160-5	

Fit&Go 3/3 sats med 1/2" hylsnycklar och 1/2" långa hylsor i lasermärkt skumplastinlägg – 67 delar



FF1A196LM

40 x 445 x 543 mm 1 FF1A196LM

7800DZ-1.1/16, 7800DZ-1.1/4, 7800DZ-1.1/8, 7800DZ-1.3/16, 7800DZ-1/2, 7800DZ-11/16, 7800DZ-13/16, 7800DZ-15/16, 7800DZ-25/32, 7800DZ-3/4, 7800DZ-3/8, 7800DZ-5/8, 7800DZ-7/16, 7800DZ-7/8, 7800DZ-9/16, 7800DZ-19/32	
7809M-10, 7809M-12, 7809M-14, 7809M-4, 7809M-5, 7809M-6, 7809M-7, 7809M-8	

7809M-5-100, 7809M-6-100, 7809M-7-100, 7809M-8-120, 7809M-10-140

K6650-1/2-1P	
S1612L	
8967	
S240	

Fit&Go 3/3 sats med 3/4" hylsor och tillbehör i lasermärkt skumplastinlägg – 17 delar



FF1A206LM

50 x 445 x 543 mm 1 FF1A206LM

SLX 17

Fit&Go 3/3 sats med 1/4" och 3/8" hylsnyckelsats, skruvmejslar med T-handtag, skjutmått och bitssats i lasermärkt skumplastinlägg – 192 delar



FF1A207LM

40 x 445 x 543 mm 1 FF1A207LM

1150-1/2H/P	
59/S100BC	
808050L	
2058-BR	
K6650-1/4-1P, K6650-3/8-1P	
6956	
6963	
8967/S3	
6966	
6954	
696EX-08	
904T-060-150	
905T-060-100	
6973A	
SL25L	
S330	



Fit&Go 3/3 sats med 1/4" och 3/8" hylsor och tillbehör samt momentnyckel i skumplastinlägg – 85 delar



FF1A213

52 x 445 x 543 mm 1 FF1A213

8150SL	
7800SM-8, 7800SM-9, 7800SM-12, 7800SM-13, 7800SM-10, 7800SM-11, 7800SM-30, 7800SM-32, 7800SM-24, 7800SM-22, 7800SM-23, 7800SM-27, 7800SM-16, 7800SM-17, 7800SM-14, 7800SM-15, 7800SM-21, 7800SM-18, 7800SM-19	
7455-200	
7809TORX-T45, 7809TORX-T40, 7809TORX-T30, 7809TORX-T20, 7809TORX-T25	
7809M-6, 7809M-5, 7809M-8, 7809M-7, 7809M-10, 7809M-14, 7809M-12	
7809M-6-140, 7809M-5-180, 7809M-10-140, 7809M-8-120	
6950SL	
6962-W, 6960-W	
6968	
6700SM-9, 6700SM-10, 6700SM-7, 6700SM-8, 6700SM-13, 6700SM-14, 6700SM-11, 6700SM-12, 6700SM-4, 6700SM-6, 6700SM-5	
6709M-6, 6709M-8, 6709M-4, 6709M-5, 6709M-3	
A6709M-2.5, A6709M-5, A6709M-6, A6709M-3, A6709M-4	
6962L	
K6650-1/4-1P	
7400SM-17, 7400SM-18, 7400SM-15, 7400SM-16, 7400SM-19, 7400SM-9, 7400SM-10, 7400SM-7, 7400SM-8, 7400SM-13, 7400SM-14, 7400SM-11, 7400SM-12, 7400SM-6	
7760-W, 7761-W	
7750SL	
7768	
8160-5, 8160-10	
8166	

Fit&Go 3/3 sats med 1/4" och 1/2" hylsor, tänger och bitssats i lasermärkt skumplastinlägg – 91 delar



FF1A214LM

40 x 445 x 543 mm 1 FF1A214LM

2058-BR	
K6650-1/4-1P, K6650-1/2-1P	
6956	
6963	
SL25	
8072	
2971G-250	
806-1-3	
2171G-160	
59/S31B	
S240	

Fit&Go 3/3 sats med klickmomentnyckel med fönster, tändstiftshylsor och 1/4" hylsor med tillbehör i lasermärkt skumplastinlägg – 79 delar



FF1A218LM

45 x 445 x 543 mm 1 FF1A218LM

1178-SCRIBE	
1547	
74WR-200	
7805ZZ-16, 7805ZZ-21	
BBR201P64014, BBR201P64016, BBR201P64018, BBR201P67814, BBR201P67816, BBR201P67818	
BWSS12P3	
MTC-3-13-C1	
7800SM-34, 7800SM-36	
SL25L	
SR200-MM	
S240	

Fit&Go 3/3 sats med 1/2" långa hylsor och insexbitshylsor i lasermärkt skumplastinlägg – 49 delar



FF1A219LM

35 x 445 x 543 mm 1 FF1A219LM

1-100-08-2-2	
S1612L	
S18HEX	
S18TORX	

Fit&Go 3/3 sats med skruvmejslar med T-handtag, insexnyckelsats i skumplastinlägg – 19 delar



FF1A1004

38 x 445 x 543 mm 1 FF1A1004

900T-050-150, 900T-020-100, 900T-025-100, 900T-030-100, 900T-040-150, 900T-060-200, 900T-080-200, 900T-100-200	
BE-9777B	

Fit&Go 3/3 sats med skruvmejslar med T-handtag i skumplastinlägg – 54 delar



FF1A1010

51 x 445 x 543 mm 1 FF1A1010

901T-010-100, 901T-015-150, 901T-020-150, 901T-025-150, 901T-027-150, 901T-030-200, 901T-040-200		
808050		
1419-MD		
7805DM-10, 7805DM-12, 7805DM-13, 7805DM-17, 7805DM-19		
BE-9678		
59S/31-1		

Fit&Go 3/3 sats med sexkantsnycklar/
TORX skruvmejslar med T-handtag 12
delar

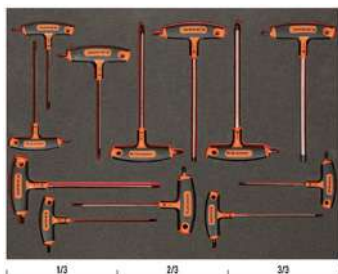

FF1A1011

35 x 445 x 543 mm	1	FF1A1011

903T-2		
903T-1		

Fit&Go 3/3 sats med skruvmejslar i
skumplastinlägg-17 delar



FF1A133

35 x 445 x 543 mm	1	FF1A133

900T-020-100, 900T-025-100, 900T-030-100, 900T-040-150, 900T-050-150, 900T-060-200, 900T-080-200, 900T-100-200		
B194.006.075, B194.007.075, B194.008.075, B194.009.075, B194.010.075, B194.015.100, B194.020.100, B194.025.125, B194.030.150		

Fit&Go 3/3 sats med skruvmejslar i
skumplastinlägg-18 delar



FF1A139

38 x 445 x 543 mm	1	FF1A139

808050		
900T-020-100, 900T-025-100, 900T-030-100, 900T-040-150, 900T-050-150, 900T-060-200, 900T-080-200, 900T-100-200		
B191.030.075, B191.040.100		
B190.055.100, B190.065.125, B190.080.150		
B195.050.025		
B195.001.025		
B192.001.100, B192.002.125		

Fit&Go 3/3 skumplastinlägg med spår- och
Phillips-skruvmejslar med T-handtag - 45
delar



FF1A71

41 x 445 x 543 mm	1	FF1A71

901T-010-100, 901T-015-150, 901T-020-150, 901T-027-150, 901T-030-200, 901T-040-200, 901T-025-150, 901T-045-200, 901T-050-200		
B190.055.125		
B191.030.075, B191.040.100		
B192.001.100, B192.002.125		
B705.1/4.125		
59/S31B		

Fit&Go 3/3 sats med ERGO™
skruvmejslar, skruvmejslar med
T-handtag och insexnycklar i lasermärkt
skumplastinlägg - 39 delar



FF1A202LM

40 x 445 x 543 mm	1	FF1A202LM

900T-025-100, 900T-030-100, 900T-040-150, 900T-050-150, 900T-060-200, 900T-080-200		
BE-8907, BE-8908, BE-8909, BE-8910, BE-8915, BE-8920, BE-8925, BE-8927, BE-8930		
BE-8702, BE-8725		
BE-9770		
BE-9785		

Fit&Go 3/3 sats med spärrskruvmejslar,
skruvmejslar med T-handtag och bitsats i
lasermärkt skumplastinlägg - 114 delar



FF1A203LM

40 x 445 x 543 mm	1	FF1A203LM

59/S100BC		
808050L		
2058-BR		
901T-010-100, 901T-015-150, 901T-020-150, 901T-025-150, 901T-027-150, 901T-030-200, 901T-040-200		



Fit&Go 3/3 sats med ERGO™ skruvmejslar, skruvmejslar med T-handtag och insexnycklar i lasermärkt skumplastinlägg – 35 delar



ergo



FF1A211LM



40 x 445 x 543 mm



1 FF1A211LM

900T-025-100, 900T-030-100,
900T-040-150, 900T-050-150,
900T-060-200, 900T-080-200



BE-8910, BE-8915, BE-8920, BE-8925,
BE-8930



BE-8020, BE-8040



BE-8050SL



BE-8150, BE-8155



BE-8355



BE-9787



BE-9770



Fit&Go 3/3 sats med fasta nycklar och bitsskruvmejsel i skumplastinlägg – 19 st



FF1A02



45 x 445 x 543 mm



1 FF1A02

111M-12, 111M-13, 111M-14, 111M-17,
111M-19, 111M-22, 111M-6, 111M-7,
111M-8, 111M-10



6M-6-7, 6M-8-9, 6M-10-11, 6M-12-13,
6M-14-15, 6M-16-17, 6M-18-19,
6M-20-22



808050L



Fit&Go 3/3 sats med fasta nycklar, spärrnycklar och skiftnyckel i skumplastinlägg – 30 delar



FF1A04



50 x 445 x 543 mm



1 FF1A04

S4RM-12-15, S4RM-16-19, S4RM-8-11



111M-30, 111M-32, 111M-6, 111M-7,
111M-8, 111M-9, 111M-10, 111M-11,
111M-12, 111M-13, 111M-14, 111M-15,
111M-16, 111M-17, 111M-18, 111M-19,
111M-21, 111M-22, 111M-24, 111M-27



6M-10-11, 6M-12-13, 6M-14-15,
6M-17-19, 6M-6-7, 6M-8-9



9071C



Fit&Go 3/3 sats med skiftnyckel, u-ringnycklar i skumplastinlägg – 34 delar



FF1A09



50 x 445 x 543 mm



1 FF1A09

111M-30, 111M-32, 111M-6, 111M-7,
111M-8, 111M-9, 111M-10, 111M-11,
111M-12, 111M-13, 111M-14, 111M-15,
111M-16, 111M-17, 111M-18, 111M-19,
111M-21, 111M-22, 111M-24, 111M-27



1320RM-10-11, 1320RM-12-13,
1320RM-8-9



6M-6-7, 6M-8-9, 6M-10-11, 6M-12-13,
6M-14-15, 6M-16-17, 6M-18-19,
6M-20-22, 6M-24-27, 6M-30-32



9071C



Fit&Go 3/3 sats med fasta nycklar och bits i skumplastinlägg – 19 delar



FF1A104



35 x 445 x 543 mm



1 FF1A104

111M-32, 111M-7, 111M-8, 111M-9,
111M-10, 111M-11, 111M-12, 111M-13,
111M-14, 111M-15, 111M-16, 111M-17,
111M-18, 111M-19, 111M-21, 111M-22,
111M-24, 111M-27



59/S54BC



Fit&Go 3/3 sats med fasta nycklar, spärrnycklar och skiftnycklar i skumplastinlägg – 22 delar



FF1A112



35 x 445 x 543 mm



1 FF1A112

S4RM/3T

111M-6, 111M-7, 111M-8, 111M-9,
111M-10, 111M-11, 111M-12, 111M-13,
111M-14, 111M-15, 111M-16, 111M-17,
111M-18, 111M-19, 111M-20, 111M-21,
111M-22, 111M-24, 111M-27



9031



9070



BAHCO

Fit&Go 3/3 sats med u-ringnycklar i skumplastinlägg-16 delar



FF1A134



37 x 445 x 543 mm



1 FF1A134

111M-30, 111M-32, 111M-6, 111M-7, 111M-8, 111M-9, 111M-10, 111M-11, 111M-12, 111M-13, 111M-14, 111M-15, 111M-16, 111M-17, 111M-18, 111M-19, 111M-20, 111M-21, 111M-22, 111M-24, 111M-27

Fit&Go 3/3 sats med fasta nycklar, ledhylsnycklar och bits i skumplastinlägg-51 delar



FF1A135



40 x 445 x 543 mm



1 FF1A135

4040M-8-9, 4040M-10-11, 4040M-12-13, 4040M-14-15, 4040M-16-17, 4040M-18-19, 4040M-20-22, 4040M-21-23

59S/31-1

6M-6-7, 6M-8-9, 6M-10-11, 6M-12-13, 6M-14-15, 6M-16-17, 6M-18-19, 6M-20-22, 6M-21-23, 6M-24-27, 6M-25-28, 6M-30-32

Fit&Go 3/3 sats med u-ringnycklar i tum, u-nycklar, skiftnycklar i skumplastinlägg-43 delar



FF1A14



46 x 445 x 543 mm



1 FF1A14

111Z-1, 111Z-1/2, 111Z-1/4, 111Z-11/16, 111Z-13/16, 111Z-15/16, 111Z-3/4, 111Z-3/8, 111Z-5/16, 111Z-5/8, 111Z-7/16, 111Z-7/8, 111Z-9/16

1320RZ-1/2-9/16, 1320RZ-1/4-5/16, 1320RZ-3/8-7/16, 1320RZ-5/16-11/32

1931Z-1/2, 1931Z-1/4, 1931Z-11/32, 1931Z-3/16, 1931Z-3/8, 1931Z-5/16, 1931Z-5/32, 1931Z-7/16, 1931Z-7/32, 1931Z-9/16, 1931Z-9/32

1950MZ-3/8

1952Z-11/32

6Z-1.1/16-1.1/4, 6Z-1-1.1/8, 6Z-1/2-9/16, 6Z-1/4-5/16, 6Z-15/16-1, 6Z-19/32-11/16, 6Z-25/32-13/16, 6Z-3/8-7/16, 6Z-5/16-11/32, 6Z-5/8-3/4, 6Z-7/8-15/16

8069 C IP

9070C

Fit&Go 3/3 sats med skiftnyckel och fasta nycklar i skumplastinlägg-33 delar



FF1A19



50 x 543 x 445 mm



1 FF1A19

111M-30, 111M-32, 111M-6, 111M-7, 111M-8, 111M-9, 111M-10, 111M-11, 111M-12, 111M-13, 111M-14, 111M-15, 111M-16, 111M-17, 111M-18, 111M-19, 111M-20, 111M-21, 111M-22, 111M-24, 111M-27

6M-6-7, 6M-8-9, 6M-10-11, 6M-12-13, 6M-14-15, 6M-16-17, 6M-18-19, 6M-20-22, 6M-21-23, 6M-24-27, 6M-30-32

92C

Fit&Go 3/3 sats med fasta nycklar, ledhylsnycklar och griptång i skumplastinlägg-18 delar



FF1A20



50 x 445 x 543 mm



1 FF1A20

2M-6-7, 2M-8-9, 2M-10-11, 2M-12-13, 2M-14-15, 2M-16-17, 2M-18-19, 2M-20-22, 2M-21-23, 2M-24-27, 2M-30-32

4040M-10-11, 4040M-12-13, 4040M-14-15, 4040M-16-17, 4040M-18-19, 4040M-21-23

2953-250

Fit&Go 3/3 sats med u-ringnycklar i skumplastinlägg-21 delar



FF1A3001



40 x 445 x 543 mm



1 FF1A3001

111M-32, 111M-30, 111M-24, 111M-22, 111M-27, 111M-17, 111M-16, 111M-15, 111M-14, 111M-21, 111M-20, 111M-19, 111M-18, 111M-9, 111M-8, 111M-7, 111M-6, 111M-13, 111M-12, 111M-11, 111M-10



Fit&Go 3/3 sats med spärrkombinycklar i skumplastinlägg-7 delar



FF1A3002



35 x 445 x 543 mm

1 FF1A3002

1RM-24, 1RM-22, 1RM-21, 1RM-19, 1RM-32, 1RM-30, 1RM-27



Fit&Go 3/3 sats med u-ringnycklar och insexnycklar i skumplastinlägg-28 delar



FF1A3003



40 x 445 x 543 mm

1 FF1A3003

1952M-27, 1952M-21, 1952M-20, 1952M-19, 1952M-18, 1952M-24, 1952M-22, 1952M-13, 1952M-12, 1952M-11, 1952M-10, 1952M-17, 1952M-16, 1952M-15, 1952M-14, 1952M-9, 1952M-8, 1952M-7, 1952M-6



BE-9778



Fit&Go 3/3 sats med u-ringnycklar och spärrkombinycklar i skumplastinlägg-30 delar



FF1A3004



48 x 445 x 543 mm

1 FF1A3004

111M-24, 111M-22, 111M-17, 111M-16, 111M-15, 111M-14, 111M-21, 111M-20, 111M-19, 111M-18, 111M-9, 111M-8, 111M-7, 111M-6, 111M-13, 111M-12, 111M-11, 111M-10



1RM-19, 1RM-10, 1RM-9, 1RM-8, 1RM-14, 1RM-13, 1RM-12, 1RM-11, 1RM-18, 1RM-17, 1RM-16, 1RM-15



Fit&Go 3/3 sats med u-ringnyckel och spärrkombinycklar i skumplastinlägg-28 delar



FF1A3005



38 x 445 x 543 mm

1 FF1A3005

1952M-19, 1952M-18, 1952M-22, 1952M-13, 1952M-12, 1952M-11, 1952M-10, 1952M-17, 1952M-16, 1952M-15, 1952M-14, 1952M-9, 1952M-8, 1952M-7, 1952M-6



1RM-6, 1RM-10, 1RM-9, 1RM-8, 1RM-7, 1RM-24, 1RM-22, 1RM-19, 1RM-14, 1RM-13, 1RM-12, 1RM-11, 1RM-17



Fit&Go 3/3 nyckel/hälverktygssats med skumplastinlägg-27 delar



FF1A5002



50 x 445 x 543 mm

1 FF1A5002

111M-30, 111M-32, 111M-6, 111M-7, 111M-8, 111M-9, 111M-10, 111M-11, 111M-12, 111M-13, 111M-14, 111M-15, 111M-16, 111M-17, 111M-18, 111M-19, 111M-20, 111M-21, 111M-22, 111M-24, 111M-27



3734S/6

Fit&Go 3/3 fil/nyckelsats med skumplastinlägg-27 delar



FF1A5006



54 x 445 x 543 mm

1 FF1A5006

1-100-08-2-2

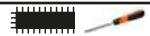

1-210-08-2-2



1-230-06-2-2, 1-230-10-2-2



111M-7, 111M-8, 111M-9, 111M-10, 111M-11, 111M-12, 111M-13, 111M-14, 111M-15, 111M-16, 111M-17, 111M-18, 111M-19, 111M-21, 111M-22



1320RM-6-7, 1320RM-8-9, 1320RM-10-11, 1320RM-12-13, 1320RM-14-15, 1320RM-16-17, 1320RM-18-19, 1320RM-22-24

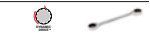

Fit&Go 3/3 sats med 3/8" hylsor och tillbehör, fasta nycklar och ledhylsnycklar i skumplastinlägg-36 delar



FF1A5027



44 x 445 x 543 mm

1 FF1A5027

2M-20-22, 2M-21-23, 2M-24-27, 2M-25-28, 2M-30-32

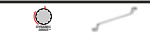

4040M-10-11, 4040M-12-13, 4040M-14-15, 4040M-16-17, 4040M-18-19, 4040M-20-22, 4040M-21-23, 4040M-8-9



7400SM-6, 7400SM-7, 7400SM-12, 7400SM-13, 7400SM-14, 7400SM-15, 7400SM-8, 7400SM-9, 7400SM-10, 7400SM-11, 7400SM-20, 7400SM-21, 7400SM-22, 7400SM-16, 7400SM-17, 7400SM-18, 7400SM-19



7754



7755-3/8



7760, 7761, 7762



7766



Fit&Go 3/3 sats med fasta nycklar och spärrnycklar, tum i skumplastinlägg – 28 delar



FF1A56



63 x 445 x 543 mm



1 FF1A56

111Z-1, 111Z-1/2, 111Z-1/4, 111Z-11/16, 111Z-13/16, 111Z-15/16, 111Z-3/4, 111Z-3/8, 111Z-5/16, 111Z-5/8, 111Z-7/16, 111Z-7/8, 111Z-9/16



1320RZ-1/2-9/16, 1320RZ-1/4-5/16, 1320RZ-3/8-7/16, 1320RZ-5/16-11/32



6Z-1.1/16-1.1/4, 6Z-1-1.1/8, 6Z-1/2-9/16, 6Z-1/4-5/16, 6Z-15/16-1, 6Z-19/32-11/16, 6Z-25/32-13/16, 6Z-5/16-11/32, 6Z-5/8-3/4, 6Z-7/8-15/16



9031



Fit&Go 3/3 sats med fasta nycklar, spärrkombinycklar och bågfil i skumplastinlägg – 28 delar



FF1A65



50 x 445 x 543 mm



1 FF1A65

111M-19, 111M-17, 111M-18, 111M-24, 111M-21, 111M-22, 111M-7, 111M-8, 111M-6, 111M-11, 111M-12, 111M-9, 111M-10, 111M-15, 111M-16, 111M-13, 111M-14, 111M-20



1RM-8, 1RM-9, 1RM-12, 1RM-13, 1RM-10, 1RM-11, 1RM-17, 1RM-14, 1RM-19



319



Fit&Go 3/3 sats med u-ringnycklar, i lasermärkt skumplastinlägg – 20 delar



FF1A198LM



35 x 445 x 543 mm



1 FF1A198LM

111M-10, 111M-11, 111M-12, 111M-13, 111M-14, 111M-15, 111M-16, 111M-17, 111M-18, 111M-19, 111M-20, 111M-21, 111M-22, 111M-24, 111M-27, 111M-30, 111M-32, 111M-34, 111M-8, 111M-9



Fit&Go 3/3 sats med skiftnycklar, spärrnycklar och ledade spärrkombinycklar, i lasermärkt skumplastinlägg – 23 delar



FF1A220LM



35 x 445 x 543 mm



1 FF1A220LM

111M-10, 111M-11, 111M-12, 111M-13, 111M-14, 111M-15, 111M-16, 111M-17, 111M-18, 111M-19, 111M-20, 111M-21, 111M-22, 111M-23, 111M-24, 111M-27, 111M-30, 111M-32, 111M-8, 111M-9



8071



Fit&Go 3/3 sats med nycklar i skumplastinlägg – 31 delar



FF1A48



44 x 543 x 445 mm



1 FF1A48

1RM-6, 1RM-7, 1RM-8, 1RM-9, 1RM-10, 1RM-11, 1RM-12, 1RM-13, 1RM-14, 1RM-17, 1RM-19, 1RM-22, 1RM-24, 1RM-27



111M-6, 111M-7, 111M-8, 111M-9, 111M-10, 111M-11, 111M-12, 111M-13, 111M-14, 111M-15, 111M-16, 111M-17, 111M-18, 111M-19, 111M-20, 111M-21, 111M-22



Fit&Go 3/3 sats med u-ringnycklar och magnetiskt upplösningsverktyg med LED-lampa i lasermärkt skumplastinlägg – 56 delar



FF1A209LM



35 x 445 x 543 mm



1 FF1A209LM



Fit&Go 3/3 sats med metrisk dubbla bockade hylsnycklar, i skumplastinlägg, 14 delar



FF1A170



40 x 445 x 543 mm



1 FF1A170



28M-16, 28M-15, 28M-18, 28M-17, 28M-12, 28M-11, 28M-14, 28M-13, 28M-24, 28M-19, 28M-22, 28M-8, 28M-10, 28M-9



Fit&Go 3/3 lasermärkt skumplastinlägg med hylsor och tillbehör för oljeplugg-31 delar



FF1A235



50 x 445 x 543 mm

kg



1 FF1A235

BE61110

BE621702, BE621703, BE621701, BE621706, BE621707, BE621704, BE621705, BE621710, BE621711, BE621708, BE621709, BE621714, BE621715, BE621712, BE621713, BE621716, BE621717



BE6810

2M-6-7, 2M-8-9, 2M-12-13, 2M-18-19, 2M-16-17, 2M-10-11, 2M-14-15, 2M-24-26, 2M-21-23, 2M-27-29, 2M-20-22, 2M-30-32



Fit&Go 3/3 sats med u-ringnycklar och tänger i skumplastinlägg-82 delar



FF1A102



40 x 445 x 543 mm



1 FF1A102



111M-32, 111M-8, 111M-9, 111M-10, 111M-11, 111M-12, 111M-13, 111M-14, 111M-15, 111M-16, 111M-17, 111M-18, 111M-19, 111M-21, 111M-22, 111M-24, 111M-27



7224

2800-180



2900-180



2890-180



2990-180



2101G-180



2628 G-180IP



Fit&Go 3/3 tängsats med skumplastinlägg-16 delar



FF1A11



43 x 543 x 445 mm



1 FF1A11



2101GC-125IP, 2101GC-160IP



21HDGC-200IP



2427 GC-200IP



2430 GC-200 IP



2628 GC-160IP



2928-160, 2928-200, 2928-250



2951-250



2952-165



8224CIP



Fit&Go 3/3 sats med fil och tänger i skumplastinlägg-14 delar



FF1A118



35 x 445 x 543 mm



1 FF1A118



1-100-08-2-2



2430 G-160 IP



2628G-200IP



2800-180



2900-180



2890-180



2990-180



5515T



1-170-08-2-2



1-210-08-2-2



1-230-08-2-2



2535F1



8224 IP



2101G-180IP



Fit&Go 3/3 sats med tänger, ledhylsnycklar och bits i skumplastinlägg-46 delar

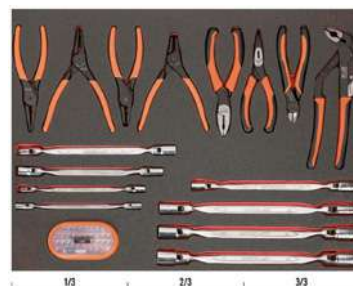

FF1A141



42 x 445 x 543 mm



1 FF1A141



2628 G-180



2430 G-160



8224



2101G-160



2800-180



2890-180



2900-180



2990-180



4040M-8-9, 4040M-10-11, 4040M-12-13, 4040M-14-15, 4040M-16-17, 4040M-18-19, 4040M-20-22, 4040M-21-23



59S/31-1



Fit&Go 3/3 sats med filar, skruvmejslar och tänger i skumplastinlägg-20 delar



FF1A145



38 x 445 x 543 mm



1 FF1A145



2628 G-180	
2430 G-160	
8224	
2101G-160	
8045LVDE	
808050	
613-3-75	
611-4-100, 611-5.5-100, 611-6.5-150, 611-8-150, 611-6.5-25	
615-1-100, 615-2-125, 615-2-25	
1-100-08-1-2	
1-160-08-1-2	
1-170-08-2-2	
1-210-08-1-2	
1-230-08-1-2	

Fit&Go 3/3 tänger i skumplastinlägg-12 delar



FF1A15



40 x 445 x 543 mm



1 FF1A15



2101GC-125IP, 2101GC-160IP	
2233D-240IP	
2421GC-180IP	
2427 GC-200IP	
2430 GC-200 IP	
2628 GC-160IP	
2650	
2855, 2855 D	
2951-180	
8224CIP	

Fit&Go 3/3 tänger och nitverktyg i skumplastinlägg-12 delar



FF1A4001



38 x 445 x 543 mm



1 FF1A4001



1520 D	
2101G-160IP	
21HDG-200IP	
2223 G-150	
2421 G-140IP, 2421 G-180 IP	
2427 G-200 IP	
2628 G-180IP	
2681	
2951-140, 2951-300	
8224 IP	

Fit&Go 3/3 tängsats med skumplastinlägg-11 delar



FF1A4002



42 x 445 x 543 mm



1 FF1A4002



2101G-160IP	
2430 G-200 IP	
2465D-200	
2628 G-160IP	
2744	
2951-140	
2952-165	
1520 G	
527 D-160	
7224	
5515FL	

Fit&Go 3/3 sats med spåringstänger i skumplastinlägg-12 delar



FF1A4003



35 x 445 x 543 mm



1 FF1A4003



2800-150, 2800-180, 2800-225	
2890-140, 2890-180, 2890-210	
2900-150, 2900-180, 2900-215	
2990-140, 2990-180, 2990-200	

Fit&Go 3/3 tång-/skiftnyckelsats med skumplastinlägg-13 delar



FF1A50



45 x 445 x 543 mm



1 FF1A50



8223 IP, 8224 IP, 8225 IP	
1420	
2430 G-160 IP	
2427 G-160 IP	
8069	
9070	
9031	
2101G-160IP	
21HDG-180IP	



Fit&Go 3/3 sats med filar, spårringstänger och dornar i skumplastinlägg-23 delar



FF1A51



40 x 445 x 543 mm



1 FF1A51



1-100-08-1-2		
1-210-08-1-2		
1-230-08-1-2		
4-144-08-2-2		
1-170-08-1-2		
3735-4-120		
3733-4, 3733-2, 3733-6		
3734-2, 3734-3, 3734-4, 3734-5, 3734-6, 3734-8		
2800-180, 2800-150		
2890-140, 2890-180		
2900-150, 2900-180		
2990-140, 2990-180		

Fit&Go 3/3 skumplastinlägg med filar, dornar, spårringstänger och insexnycklar - 30 delar



FF1A68



37 x 445 x 543 mm



1 FF1A68



1-100-08-1-2		
1-170-08-1-2		
1-210-08-1-2		
1-230-08-1-2		
2800-180		
2890-180		
2900-180		
2990-180		
3733-4, 3733-2, 3733-6		
3734-8, 3734-5, 3734-6, 3734-3, 3734-4, 3734-2		
3735-4-120		
4-144-08-2-2		
481-400		
BE-9770		

Fit&Go 3/3 sats med rörtång, hållande tång, avbitartång och spårringstång i lasermärkt skumplastinlägg-14 delar



FF1A200LM



35 x 445 x 543 mm



1 FF1A200LM

1520 G		
1620		
2101G-160		
2223 S-150		
2233 D-160		
2430 G-190HD		
2628 G-180		
2890-180		
2990-180		
C3330R		
C3530		
C3230		
C3640		
8224		

Fit&Go 3/3 sats med tänger och insexnycklar av T-typ i lasermärkt skumplastinlägg - 15 delar



FF1A223LM



35 x 445 x 543 mm



1 FF1A223LM

5226 DC		
158-N		
158-NB		
21HDG-200		
2430 G-190HD		
2628G-200IP		
2968-190		
8224 IP		
BE1P		
BE1TH-2.5, BE1TH-3, BE1TH-4, BE1TH-5, BE1TH-6, BE1TH-8		

Fit&Go 3/3 sats med hammare, tänger, bågfil, fil och måttband i skumplastinlägg-18 st



FF1A03



50 x 445 x 543 mm



1 FF1A03



BE-9770		
MTB-5-25		
3734N-4-150, 3734N-6-150		
1-100-08-2-2		
2171G-160		
2971G-250		
481-400		
2678 G-160		
306		

Fit&Go 3/3 sats med skruvmejslar, tänger och måttband i skumplastinlägg-23 delar



FF1A06



45 x 445 x 543 mm



1 FF1A06



BE-8020L, BE-8040		
BE-8150, BE-8255, BE-8256		
BE-8350		
BE-8601		
BE-8610, BE-8620		
BE-8910, BE-8915, BE-8920, BE-8925, BE-8927, BE-8930		
MTB-3-16		
2101G-160IP		
2427 G-200 IP		
2535L		
2628 G-160IP		
2951-180		
5515T-52		
8224 IP		

Fit&Go 3/3 sats med filar, hammare, bågfil, dornar universalkniv etc i skumplastinlägg-15 delar



FF1A07



40 x 445 x 543 mm



1 FF1A07



3734N-3-150, 3734N-5-150, 3734N-6-150	
3735N-4-120	
3740-175	
SQZ150003	
1-100-08-2-2	
1-210-08-2-2	
1-230-08-2-2	
2744	
3625W-35	
3745-150	
481-400	
782-U	
317	

Fit&Go 3/3 sats med hammare, bågfil, kniv och mätverktyg i skumplastinlägg-11 delar



FF1A110



50 x 445 x 543 mm



1 FF1A110



2535L	
426TOR9	
9572-200	
MTB-8-25	
SQZ150003	
3875-LY3	
479-24	
481-400	
529-20-L	
225-PLUS	
208	

Fit&Go 3/3 sats med hammare, dornar, tänger etc i skumplastinlägg-18 st



FF1A114



42 x 445 x 543 mm



1 FF1A114



8224 IP	
2632	
3734-2, 3734-3, 3734-4, 3734-5, 3734-6, 3734-8	
2800-180	
2890-180	
2900-180	
2990-180	
4611-2	
479-24	
1435/5	
1178-SCRIBE	
2430 G-160 IP	
2101G-180IP	

Fit&Go 3/3 sats med bågfil, mätverktyg, fil etc i skumplastinlägg-9 delar



FF1A115



35 x 445 x 543 mm



1 FF1A115



1-210-08-1-2	
9045-B-250	
406T-225	
MTB-5-25	
K-AP-1	
268	
5515T-52	
319	

Fit&Go 3/3 sats med skruvmejslar, fasta nycklar och skiftnyckel i skumplastinlägg-26 delar



FF1A117



35 x 445 x 543 mm



1 FF1A117



B191.040.100	
B190.055.125, B190.065.150	
B192.000.075, B192.001.100, B192.002.125	
111M-32, 111M-6, 111M-7, 111M-8, 111M-9, 111M-10, 111M-11, 111M-12, 111M-13, 111M-14, 111M-15, 111M-16, 111M-17, 111M-18, 111M-19, 111M-21, 111M-22, 111M-24, 111M-27	
8073 IP	

Fit&Go 3/3 sats med bågfil, dornar och mätverktyg i skumplastinlägg-10 delar

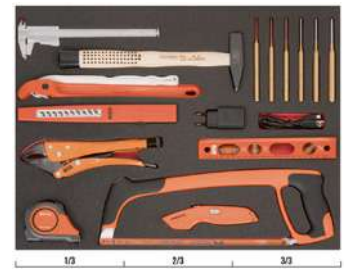

FF1A119



47 x 445 x 543 mm



1 FF1A119



3734S/6	
481-300	
KGAU-01	
MTB-5-25-M-E	
137-10	
1150-1/2H/P	
426TOR9	
BLTS10	
375-8	
319	



Fit&Go 3/3 lasermärkt skumplastinlägg med verktyg för karosseriarbete–13 delar



FF1A236

55 x 445 x 543 mm 9.5 kg 1 FF1A236

3-330-14-2-0	
9-462-14-0-0	
1467-250	
BBSH2F	
BBSH2CA	
BBSDW	
BBSDA	
BBSDT	
BBSDH	
BBSDC	
BBSDHR	
BBSS1	
2485	

Fit&Go 3/3 sats med filar, hammare, bågfil etc i skumplastinlägg–19 delar



FF1A12

35 x 445 x 543 mm 1 FF1A12

FS-8	
1-100-06-1-2, 1-100-06-2-2	
1-160-06-1-2	
1-210-06-1-2	
1-230-06-1-2	
2509	
2535F2	
3625W-35	
3734-3, 3734-5, 3734-8	
3735-4-120	

3740-150	
3745-150	
481-300, 481-500	
319	
8157-15	

Fit&Go 3/3 sats med tänger och fasta nycklar i skumplastinlägg–28 delar



FF1A121

40 x 445 x 543 mm 1 FF1A121

111M-8, 111M-9, 111M-10, 111M-11, 111M-12, 111M-13, 111M-14, 111M-15, 111M-16, 111M-17, 111M-18, 111M-19, 111M-22	
2470 G-200	
7224	
2953-250	
6M-6-7, 6M-8-9, 6M-10-11, 6M-12-13, 6M-14-15, 6M-16-17, 6M-18-19, 6M-20-22	
2800-180	
2900-180	
2101G-160IP	

Fit&Go 3/3 sats med fasta nycklar och skruvmejslar i skumplastinlägg–25 delar



FF1A124

45 x 445 x 543 mm 1 FF1A124

B191.040.100	
B190.055.125, B190.065.150	
B192.000.075, B192.001.100, B192.002.125	

111M-32, 111M-6, 111M-7, 111M-8, 111M-9, 111M-10, 111M-11, 111M-12, 111M-13, 111M-14, 111M-15, 111M-16, 111M-17, 111M-18, 111M-19, 111M-21, 111M-22, 111M-24, 111M-27	
---	--

Fit&Go 3/3 hammare, dornar, tänger, kniv, måttband i skumplastinlägg–11 delar



FF1A127

35 x 445 x 543 mm 1 FF1A127

3734S/6	
479-16	
3625W-35	
MTG-3-16	
KB18-01	
KSBG18-10DISPEN	
8224 IP	
2101G-160IP	
2628 G-180IP	
2430 G-200 IP	
2530	

Fit&Go 3/3 sats med hammare, kapverktyg, tänger, i skumplastinlägg, 14 delar



FF1A185

40 x 445 x 543 mm 1 FF1A185

479-16	
3625W-35	
KB18-01	
KSBG18-10DISPEN	
2101G-180IP	
2470 G-200	
2678 G-180	
8224 IP	
2530	

Fit&Go 3/3 sats med fasta nycklar, skiftnyckel, filar och rörtång i skumplastinlägg-18 delar



FF1A128



65 x 445 x 543 mm



1 FF1A128



9029, 9031

111Z-1/4, 111Z-5/16, 111Z-3/8, 111Z-7/16, 111Z-1/2, 111Z-9/16, 111Z-5/8, 111Z-11/16, 111Z-3/4, 111Z-13/16, 111Z-7/8, 111Z-1

1-473-08-2-2

361-12

2633/S4

S4RM/5T

Fit&Go 3/3 sats med tänger, skruvmejslar och bits i skumplastinlägg-16 delar



FF1A129



45 x 445 x 543 mm



1 FF1A129



2171G-180

2470 G-200

2477 G-200

9033, 9035

1520 G

808050P

B191.040.100

B190.055.125, B190.065.150

B192.000.075, B192.001.100, B192.002.125

BE-9777B

2678 G-200

59S/31-1

Fit&Go 3/3 sats med hammare, dornar, bågfilar etc i skumplastinlägg-10 st



FF1A131



40 x 445 x 543 mm



1 FF1A131



SQZ150003

FS-8

SQZ150003-SBL

481-400

3734-2, 3734-4, 3734-5, 3734-6, 3734-8, 3734-3

3735-5-120

3740-175

BE-9678

1547

319

208

3625N-32

Fit&Go 3/3 sats med filar, hylsor och tillbehör, hål- och nitverktyg, sjutmått i skumplastinlägg-31 delar



FF1A132



40 x 445 x 543 mm



1 FF1A132



7400SM-6, 7400SM-7, 7400SM-8, 7400SM-9, 7400SM-10, 7400SM-11, 7400SM-12, 7400SM-13, 7400SM-14, 7400SM-15, 7400SM-16, 7400SM-17, 7400SM-18, 7400SM-19

7750SL

SBS705

SBS755

SBS723, SBS724

SBS775

SBS760, SBS761, SBS762

1-100-08-1-2

1-160-08-1-2

1-170-08-2-2

1-210-08-1-2

1-230-08-1-2

2635

1150D

2681

Fit&Go 3/3 sats med 1/4" hylsor och tillbehör, tänger och skruvmejslar i skumplastinlägg-40 delar



FF1A136



40 x 445 x 543 mm



1 FF1A136



2628 G-180

2430 G-160

8224

2101G-160

6700SM-4.5, 6700SM-5, 6700SM-5.5, 6700SM-6, 6700SM-7, 6700SM-8, 6700SM-9, 6700SM-10, 6700SM-11, 6700SM-12, 6700SM-13, 6700SM-14, 6700SM-4

6950SL

SBS67

SBS69

SBS65

SBS63-2, SBS63-4, SBS63-6

2800-180

2890-180

2900-180

2990-180

B191.030.075, B191.040.100

B190.055.100, B190.065.125, B190.080.150

B195.050.025

B195.001.025

B192.001.100, B192.002.125

808050

6954



Fit&Go 3/3 sats med hammare, dornar, bågfilar etc i skumplastinlägg-16 delar



FF1A138

40 x 445 x 543 mm 1 FF1A138

SQZ150003	
FS-8	
SQZ150003-SBL	
481-400	
3734-2, 3734-3, 3734-4, 3734-5, 3734-6, 3734-8	
3735-5-120	
3740-175	
BE-9678	
319	
208	
3625N-32	

Fit&Go 3/3 sats med hammare, dornar, bågfilar etc i skumplastinlägg-15 delar



FF1A143

45 x 445 x 543 mm 1 FF1A143

SQZ150003	
FS-8	
SQZ150003-SBL	
MTB-5-25	
481-400	
3734-2, 3734-3, 3734-4, 3734-5, 3734-6, 3734-8	
3735-5-120	
3740-175	
319	
208	
3625N-32	

Fit&Go 3/3 sats med skruvmejslar, tänger, hammare, bågfil etc i skumplastinlägg-16 delar



FF1A147

40 x 445 x 543 mm 1 FF1A147

2951-250, 2951-180	
SQZ150003	
SQZ150003-SBL	
B191.030.075, B191.040.100	
B190.055.100, B190.065.125, B190.080.150	
B195.050.025	
B195.001.025	
B192.001.100, B192.002.125	
319	
208	
3625N-32	

Fit&Go 3/3 blandad verktygssats med skumplastinlägg-18 delar



FF1A16

40 x 445 x 543 mm 1 FF1A16

KE18-01	
1150-1/2H/P	
MTB-3-16	
1177-SCRIBE	
1544	
2509	
2535F2	
2632	
268	
2744	
2820EF2	
3525HB	
5471 F-145	
5515T	

5515T-52

5516

SR300-E

Fit&Go 3/3 sats med hammare, filar, sylar etc i skumplastinlägg-24 delar



FF1A18

44 x 445 x 543 mm 1 FF1A18

1-476-04-3-2	
2633/S4	
3734S/6	
3736S/6	
481-200, 481-500	
782-U	
3625N-32	

Fit&Go 3/3 sats med tänger, hammare, dornar etc i skumplastinlägg-21 delar



FF1A23

40 x 445 x 543 mm 1 FF1A23

3735-4-120	
3734-2, 3734-3, 3734-4, 3734-5, 3734-6, 3734-8	
2630GC-180IP	
2430 GC-200 IP	
2427 GC-200IP	
2900-180	
2890-180	
2990-180	
2800-180	
7224	
2101GC-160IP	
479-16	
1547	











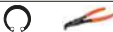

MTB-3-16	
SC127	
3625N-32	

Fit&Go 3/3 måttband, hammare, tänger i skumplastinlägg-19 delar





FF1A24 

 45 x 445 x 543 mm  1 FF1A24



3735-4-120	
3734-2, 3734-3, 3734-4, 3734-5, 3734-6, 3734-8	
2630GC-180IP	
2430 GC-200 IP	
2900-180	
2890-180	
2990-180	
2800-180	
7224	
2101GC-160IP	
479-16	
3625N-32	
MTB-3-16	
SC127	





Fit&Go 3/3 sats med fasta nycklar och tänger i skumplastinlägg-27 delar





FF1A26 

 50 x 445 x 543 mm  1 FF1A26



111M-30, 111M-32, 111M-6, 111M-7, 111M-8, 111M-9, 111M-10, 111M-11, 111M-12, 111M-13, 111M-14, 111M-15, 111M-16, 111M-17, 111M-18, 111M-19, 111M-20, 111M-21, 111M-22, 111M-24, 111M-27	
2630GC-180IP	
2430 GC-200 IP	















7224	
2953-250	
2101GC-160IP	
SC127	

Fit&Go 3/3 sats med hammare, dornar, 1/2", 1/4" hysor och tillbehör i skumplastinlägg-48 delar





FF1A28 



 50 x 445 x 543 mm  1 FF1A28











7800SM-18, 7800SM-19, 7800SM-21, 7800SM-22, 7800SM-23, 7800SM-24, 7800SM-27, 7800SM-30, 7800SM-32, 7800SM-10, 7800SM-12, 7800SM-13, 7800SM-14, 7800SM-15, 7800SM-16, 7800SM-17	
8150SL	
6700SM-4.5, 6700SM-5, 6700SM-5.5, 6700SM-6, 6700SM-7, 6700SM-8, 6700SM-9, 6700SM-10, 6700SM-11, 6700SM-12, 6700SM-13, 6700SM-4	
6954	
6960, 6962	
6966	
6950SL	
3735-4-120	
3734-2, 3734-3, 3734-4, 3734-5, 3734-6, 3734-8	
479-16	
MTB-3-16	
3625N-32	
8154-11	
8160-3, 8160-5	
8166	

Fit&Go 3/3 sats med filar, hammare, bågfilar, insexnycklar etc i skumplastinlägg-24 delar





FF1A35 



 42 x 445 x 543 mm  1 FF1A35

















317	
1-100-08-1-2	
1-210-08-1-2	
1-230-08-1-2	
MTB-3-16	
3625W-35	
481-300	
782-U	
BE-9770	
KG09-01	
4040M-8-9, 4040M-10-11, 4040M-12-13, 4040M-14-15, 4040M-16-17	

Fit&Go 3/3 sats med 1/4" hylsor och tillbehör, ledhylsnycklar, bits och bitsmejslar i skumplastinlägg-89 delar



FF1A36 

 50 x 445 x 543 mm  1 FF1A36

4040M-8-9, 4040M-10-11, 4040M-12-13, 4040M-14-15, 4040M-16-17	
808050S	
808050	
6972H	
K6650-1/4-1P	
6950SL	
59S/31-1	
59S/H2, 59S/H3, 59S/H4, 59S/H5, 59S/H6, 59S/H8	
8030-2P, 8040-2P, 8242-2P, 8252-2P	
8610-2P, 8620-2P, 8630-2P	
8810-2P, 8820-2P, 8830-2P	
8910-2P, 8915-2P, 8925-2P, 8930-2P, 8940-2P	
BE-8575	
SBS60-11, SBS60-12, SBS60-13, SBS60-4, SBS60-4.5, SBS60-5, SBS60-5.5, SBS60-6, SBS60-7, SBS60-8, SBS60-9, SBS60-10	
SB6963	
SBS64	



Fit&Go 3/3 sats med hammare, tänger, måttband och bågfilare i skumplastinlägg-9 delar



FF1A41



42 x 445 x 543 mm

1 FF1A41

Fit & Go

2171G-160



2470 G-160



2971G-250



MTB-3-16



WR2-12



3625W-35



481-300



218



306



Fit&Go 3/3 sats med hammare, skiftnyckel, polygrip, hylsor och tillbehör 1/4", 1/2" i skumplastinlägg-60 delar



FF1A5007



50 x 445 x 543 mm

1 FF1A5007

Fit & Go

K6650-1/4-1P



3734-2, 3734-3, 3734-4, 3734-5,
3734-6, 3734-8



481-400



6700SM-11, 6700SM-12, 6700SM-13,
6700SM-14, 6700SM-10, 6700SM-5,
6700SM-6, 6700SM-7, 6700SM-8,
6700SM-9, 6700SM-4



6709F-8, 6709F-5.5



6709M-3, 6709M-4, 6709M-5, 6709M-6



6709PH-1, 6709PH-2



6950SL



6954



6960, 6962



6966



7800SM-18, 7800SM-19, 7800SM-10,
7800SM-11, 7800SM-12, 7800SM-13,
7800SM-14, 7800SM-15, 7800SM-16,
7800SM-17, 7800SM-21, 7800SM-22,
7800SM-23, 7800SM-24, 7800SM-25,
7800SM-26, 7800SM-27, 7800SM-28,
7800SM-30, 7800SM-32



8072 IP



B145.006.100



8150SL



8224 IP



8154-11



8160-5, 8160-10



8166



Fit&Go 3/3 sats med hammare, dornar, filar, skiftnycklar, mätverktyg etc i skumplastinlägg-24 st



FF1A5008



50 x 445 x 543 mm

1 FF1A5008

Fit & Go

1-100-08-2-2



1-160-08-2-2



1-170-08-2-2



1-210-08-2-2



1-230-08-2-2



1150D



1450D-ISO



1547



3625N-40



3734-2, 3734-3, 3734-4, 3734-5,
3734-6, 3734-8



3735-4-120, 3735-5-150



3740-125, 3740-150



38-20



5515T



9029, 9031



MTB-3-16



Fit&Go 3/3 sats med isolerade tänger och skruvmejslar i skumplastinlägg-17 delar



FF1A5009



38 x 445 x 543 mm

1 FF1A5009

Fit & Go

2101S-160



2223 S-150



2250V-170



2430 S-200



2628 S-180



8072V



BE-8220S, BE-8040S, BE-8050S,
BE-8255S, BE-8065S



BE-8340



BE-8601



BE-8610S, BE-8620S



BE-8810S, BE-8820S



Fit&Go 3/3 sats med filar, hammare, dornar, tänger och skiftnycklar i skumplastinlägg-22 st



FF1A5010



35 x 445 x 543 mm

1 FF1A5010

Fit & Go

1-100-08-1-2



1-160-08-1-2



1-170-08-2-2



1-210-08-1-2



1-230-08-1-2



2101G-180IP



2427 G-200 IP



2430 G-200 IP



2628 G-180IP

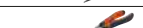

3733-2, 3733-4, 3733-6



3734-2, 3734-3, 3734-4, 3734-5,
3734-6, 3734-8



3735-4-120



481-300



8069 IP



9031



Fit&Go 3/3 sats med filar, skruvmejslar, tänger, skiftnyckel, hammare, dornar och måttband i skumplastinlägg-27 delar



FF1A5011

44 x 445 x 543 mm 1 FF1A5011

1-476-04-3-2	
1178-SCRIBE	
1547	
2101G-160IP	
2427 G-160 IP	
2430 G-160 IP	
3734-2, 3734-3, 3734-4, 3734-5, 3734-6, 3734-8	
3735-5-120	
481-500	
BE-8020L, BE-8040	
BE-8150, BE-8255, BE-8256	
BE-8610, BE-8620	
MTB-3-16	

Fit&Go 3/3 slag- och mätverktygssats med skumplastinlägg-13 delar



FF1A5012

48 x 445 x 543 mm 1 FF1A5012

141	
3734-2, 3734-3, 3734-4, 3734-5, 3734-6	
479-08	
481-1000, 481-300	
782-U	
MTS-5-25	
SQZ150003	
319	

Fit&Go 3/3 sats med skruvmejslar, bågfilar, måttband etc i skumplastinlägg-17 delar



FF1A5015

45 x 445 x 543 mm 1 FF1A5015

319	
268	
208	
2509	
2444	
2744	
5515T	
BE-8020L, BE-8040	
BE-8150, BE-8255, BE-8256	
BE-8340	
BE-8601	
BE-8610, BE-8620	
MTB-5-25	

Fit&Go 3/3 sats med fasta nycklar, hammare, dornar, huggmejsel i skumplastinlägg-16 delar



FF1A5017

35 x 445 x 543 mm 1 FF1A5017

3734-2, 3734-3, 3734-4, 3734-5, 3734-6, 3734-8	
3735-5-120	
3740-175	
481-400	
111M-21, 111M-22, 111M-24, 111M-27, 111M-32, 111M-30	
3625N-32	

Fit&Go 3/3 sats med fasta nycklar, tänger, hylsor och tillbehör 1/2" i skumplastinlägg-47 delar



FF1A5019

52 x 445 x 543 mm 1 FF1A5019

111M-17, 111M-18, 111M-19, 111M-20, 111M-6, 111M-7, 111M-8, 111M-13, 111M-14, 111M-15, 111M-16, 111M-9, 111M-10, 111M-11, 111M-12	
2101G-160IP	
2430 G-160 IP	
2628 G-180IP	
7800DM-12, 7800DM-13, 7800DM-14, 7800DM-15, 7800DM-10, 7800DM-11, 7800DM-20, 7800DM-21, 7800DM-22, 7800DM-23, 7800DM-16, 7800DM-17, 7800DM-18, 7800DM-19, 7800DM-28, 7800DM-30, 7800DM-32, 7800DM-24, 7800DM-25, 7800DM-26, 7800DM-27, 7800DM-8, 7800DM-9	
8155-1/2	
8224 IP	
8154-11	
8160-5, 8160-10	
8166	

Fit&Go 3/3 sats med bågfilar, skruvmejslar, måttband, kniv etc i skumplastinlägg-17 delar



FF1A5021

45 x 445 x 543 mm 1 FF1A5021

BE-8020L, BE-8040	
BE-8150, BE-8255, BE-8256	
BE-8340	
BE-8601	
BE-8610, BE-8620	
319	
MTB-5-25	
2444	
268	
5515T	
2509	
2744	
208	



Fit&Go 3/3 sats med tänger/nycklar/hylsnycklar med skumplastinlägg-26 delar



FF1A5022

50 x 445 x 543 mm 1 FF1A5022

6700SM-4.5, 6700SM-5, 6700SM-5.5, 6700SM-6, 6700SM-7, 6700SM-8, 6700SM-9, 6700SM-10, 6700SM-11, 6700SM-12, 6700SM-13, 6700SM-14, 6700SM-4	
6950	
6954	
6956	
6960, 6962	
6966	
8070	
9031	
9072 P	
141	
2101G-160IP	
2430 G-160 IP	
2628 G-180IP	
8224 IP	

Fit&Go 3/3 sats med bågfilare, skruvmejslar, kniv etc i skumplastinlägg-16 delar



FF1A5023

45 x 445 x 543 mm 1 FF1A5023

208	
2444	
2509	
268	
2744	
319	
5515T	
BE-8020L, BE-8040	

BE-8150, BE-8255, BE-8256	
BE-8340	
BE-8601	
BE-8610, BE-8620	

Fit&Go 3/3 sats med fasta nycklar, spärrkombinycklar, skiftnycklar och tänger i skumplastinlägg-28 delar



FF1A5024

45 x 445 x 543 mm 1 FF1A5024

111M-12, 111M-13, 111M-6, 111M-7, 111M-8, 111M-9, 111M-10, 111M-11	
1RM-17, 1RM-18, 1RM-19, 1RM-8, 1RM-9, 1RM-10, 1RM-11, 1RM-12, 1RM-13, 1RM-14, 1RM-15, 1RM-16	
2101G-160IP	
2430 G-160 IP	
141	
2628 G-180IP	
9031	
9072 P	
8070	
8224 IP	

Fit&Go 3/3 sats med fasta nycklar, skruvmejslar etc i skumplastinlägg-32 delar



FF1A5028

45 x 445 x 543 mm 1 FF1A5028

111M-6, 111M-7, 111M-8, 111M-9, 111M-10, 111M-11, 111M-14, 111M-15, 111M-16, 111M-17, 111M-18, 111M-19, 111M-20, 111M-12, 111M-13	
1419-MD	
BE-8906, BE-8907, BE-8908, BE-8909, BE-8910, BE-8915, BE-8920, BE-8925, BE-8927, BE-8930, BE-8940, BE-8945	
7805DM-12, 7805DM-13, 7805DM-17, 7805DM-10, 7805DM-19	

Fit&Go 3/3 tänger, skiftnycklar, hylsor och tillbehör i skumplastinlägg-29 delar



FF1A5029

40 x 445 x 543 mm 1 FF1A5029

2628 G-180IP	
2101G-160IP	
2430 G-160 IP	
8224 IP	
BBR201P6	
BE5103	
2M-10-11, 2M-12-13, 2M-14-15, 2M-16-17, 2M-18-19, 2M-6-7, 2M-8-9	
7809TORX-T50, 7809TORX-T55, 7809TORX-T25, 7809TORX-T30, 7809TORX-T40, 7809TORX-T45	

Fit&Go 3/3 sats med fasta nycklar, griptänger, nylonhammare, hylsor och tillbehör 1/2" i skumplastinlägg-45 delar



FF1A5030

52 x 445 x 543 mm 1 FF1A5030

111M-17, 111M-18, 111M-19, 111M-20, 111M-6, 111M-7, 111M-8, 111M-13, 111M-14, 111M-15, 111M-16, 111M-9, 111M-10, 111M-11, 111M-12	
2951-180, 2951-250	
7800DM-12, 7800DM-13, 7800DM-14, 7800DM-15, 7800DM-8, 7800DM-9, 7800DM-10, 7800DM-11, 7800DM-20, 7800DM-21, 7800DM-22, 7800DM-23, 7800DM-16, 7800DM-17, 7800DM-18, 7800DM-19, 7800DM-28, 7800DM-30, 7800DM-32, 7800DM-24, 7800DM-26, 7800DM-27	
8155-1/2	
3625N-32	
8154-11	
8160-5, 8160-10	
8166	

Fit&Go 3/3 sats med bitshylsor, bitsskruvmejsel, bits, insexnycklar och magnetskål i skumplastinlägg-62 delar



FF1A5031



48 x 445 x 543 mm

1 FF1A5031

1419-MD

7809M-10, 7809M-12, 7809M-14, 7809M-17, 7809M-19, 7809M-7, 7809M-8, 7809M-5, 7809M-9, 7809M-6

BE-9678

7809M-10-140, 7809M-5-180, 7809M-6-140, 7809M-7-100, 7809M-8-120

59S/31-1

808050

7805DM-12, 7805DM-13, 7805DM-17, 7805DM-19, 7805DM-10

Fit&Go 3/3 slangklämmsats i skumplastinlägg-6 delar



FF1A5036



38 x 445 x 543 mm

1 FF1A5036

BE258

BE250

BE256P3

BE254A

Fit&Go 3/3 sats med bromskolvsvrtyg i skumplastinlägg-50 delar



FF1A5038



45 x 445 x 543 mm

1 FF1A5038

BBR300P50

Fit&Go 3/3 sats med skruvmejslar, insexnycklar, nylonhammare, spåringsstänger i skumplastinlägg-38 delar



FF1A53



45 x 445 x 543 mm

1 FF1A53

BE-8800, BE-8811, BE-8821

BE-8830

BE-8600, BE-8611, BE-8621

BE-8630

BE-8910, BE-8915, BE-8920, BE-8925

BE-9770

BE-9780

3625S-44

2800-225

2890-210

Fit&Go 3/3 sats med skruvmejslar, bits och mätverktyg i skumplastinlägg-50 delar



FF1A66



50 x 445 x 543 mm

1 FF1A66

038.055.100, 038.065.125, 038.080.150

039.001.100, 039.002.125

1178-SCRIBE

426TOR9

6972H

9045-B-250

BE-8010S, BE-8230S

BE-8040

BE-8150, BE-8155

BE-8800, BE-8811, BE-8821

BE-8830

MTB-5-25

SQZ150003

59S/31-1

Fit&Go 3/3 skumplastinlägg med skruvmejslar, skiftnycklar och tänger - 28 delar



FF1A67



39 x 445 x 543 mm

1 FF1A67

9031

2101G-160IP

21HDG-180IP

2427 G-160 IP

2430 G-160 IP

8224 IP

BE-8600, BE-8611, BE-8621

BE-8630

BE-8910, BE-8915, BE-8920, BE-8925

7865



Fit&Go 3/3 skumplastinlägg med tänger – 18 delar



FF1A72

38 x 445 x 543 mm 1 FF1A72

2101GC-160IP	
2430 GC-200 IP	
2630GC-180IP	
2800-180	
2890-180	
2900-180	
2953-200	
2990-180	
3640-200-C	
3734N-10-150, 3734N-2-150, 3734N-3-150, 3734N-4-150, 3734N-5-150, 3734N-6-150, 3734N-8-150	
479-16	
3625W-35	

Fit&Go 3/3 sats med hammare, kapverktyg och tänger i skumplastinlägg – 13 delar



FF1A154

37 x 445 x 543 mm 1 FF1A154

2171G-160	
224 D	
2470 G-160	
317	
3625W-28	
3733-4	
3734-3, 3734-6	
3735-5-120	
481-400	
KB18-01	
KSBG18-10DISPEN	
2678 G-180	

Fit&Go 3/3 sats med 1/4" och 1/2" hylsor, nycklar och tänger i skumplastinlägg – 50 delar



FF1A164

40 x 445 x 543 mm 1 FF1A164

1RM-10, 1RM-11, 1RM-12, 1RM-13, 1RM-14, 1RM-15, 1RM-16, 1RM-17, 1RM-18, 1RM-19, 1RM-8	
2058-BR	
S330	
111M-24, 111M-21, 111M-27, 111M-32	

Fit&Go 3/3 sats med tänger, insexnycklar, magnetisk skål och upplockningsverktyg i lasermärkt skumplastinlägg – 23 delar



FF1A167

45 x 445 x 543 mm 1 FF1A167

1178-SCRIBE	
1419-MD	
2101G-160IP	
2430 G-190HD	
2628 G-180IP	
2744	
2953-250	
8224	
9031	
BE-9770	
BWSS12P317, BWSS12P319, BWSS12P321	
CR B 02	
2530	

Fit&Go 3/3 sats med kapverktyg, filar och slagskruvmejsel i lasermärkt skumplastinlägg – 13 delar



FF1A169

35 x 445 x 543 mm 1 FF1A169

2681	
3625W-28	
3733-4	
3734-3, 3734-4, 3734-6	
3735-5-120	
481-400	
BB10	
BE66152	
BT10P330	
MA321	
MTB-3-16	

Fit&Go 3/3 sats med kapverktyg, filar och slagskruvmejsel i lasermärkt skumplastinlägg – 36 delar



FF1A168

40 x 445 x 543 mm 1 FF1A168

1-100-08-2-2	
1-210-08-2-2	
1-230-08-2-2	
2485	
2487	
319	
268	
3740-100, 3740-150	
5515T	
782-U	
7865	
KB18-01	
KSBG18-10DISPEN	

Fit&Go 3/3 sats med hammare, tänger, kapverktyg och gripverktyg i skumplastinlägg – 25 delar



FF1A189



40 x 445 x 543 mm



1 FF1A189

3734S/6	
479-16	
3625W-35	
MTG-3-16	
KB18-01	
KSBG18-10DISPEN	
2101G-180IPD	
2630GC-180IP	
2470 G-200	
8224 IP	
2530	

Fit&Go 3/3 sats med 1/2" krafthylsor i lasermärkt skumplastinlägg, kap- och måttverktyg – 36 delar



FF1A197LM



40 x 445 x 543 mm



1 FF1A197LM

1150-1/2H/P	
2744	
426TOR9	
K7801M-13, K7801M-15, K7801M-16, K7801M-17, K7801M-18, K7801M-19, K7801M-21, K7801M-22, K7801M-24	
K8160D-2	
K7806M-13, K7806M-14, K7806M-16, K7806M-17, K7806M-18, K7806M-19, K7806M-21, K7806M-22, K7806M-24	
KBGU-10P-DISPEN	
KERU-01	
MTC-5-16-C1	
325	
1544	

Fit&Go 3/3 sats med hammare och filar i lasermärkt skumplastinlägg – 40 delar



FF1A204LM



40 x 445 x 543 mm



1 FF1A204LM

1-100-08-2-2	
1-170-08-2-2	
1-210-08-2-2	
1-230-08-2-2	
1435/5	
3734-2, 3734-3, 3734-4, 3734-5, 3734-6, 3734-8	
3735-4-120, 3735-5-120	
3740-150, 3740-250	
481-400	
7865	
3625N-32	
1418-4, 1418-5, 1418-6, 1418-7.5	

Fit&Go 3/3 sats med sylar, krokar, inspektionsspeglar och nittång i lasermärkt skumplastinlägg – 14 delar



FF1A205LM



35 x 445 x 543 mm



1 FF1A205LM

2484-45	
2633/S4	
2951-180	
5515T	
BE66152	
BE-8986	
BT10P330	
2681	
1450D-ISO	
806-1-3	
5515FL	

Fit&Go 3/3 sats med 1/2" hylsor och tillbehör, 1/2" krafthylsor och kapverktyg i lasermärkt skumplastinlägg – 56 delar



FF1A208LM



45 x 445 x 543 mm



1 FF1A208LM

2744	
7809M-10, 7809M-12, 7809M-14, 7809M-4, 7809M-5, 7809M-6, 7809M-7, 7809M-8	
K7801M-13, K7801M-15, K7801M-16, K7801M-17, K7801M-18, K7801M-19, K7801M-21, K7801M-22, K7801M-24	
K8160D-2	
KBGU-10P-DISPEN	
KERU-01	
319	
K6650-1/2-1P	
S240	

Fit&Go 3/3 sats med ERGO™ skruvmejslar, nycklar och tänger i lasermärkt skumplastinlägg – 24 delar



FF1A210LM



40 x 445 x 543 mm



1 FF1A210LM

1RM-10, 1RM-11, 1RM-12, 1RM-13, 1RM-14, 1RM-15, 1RM-16, 1RM-17, 1RM-18, 1RM-19, 1RM-8, 1RM-9	
1520 G	
2101G-160	
2430 G-190HD	
2628 G-180	
BE-8602	
BE-8611, BE-8621	
BE-8811, BE-8821	
BE-8802	
8224	
9031	



Fit&Go 3/3 sats med ERGO™ skruvmejslar, skruvmejslar med T-handtag och insexnycklar i lasermärkt skumplastinlägg – 18 delar



ergo™



FF1A212LM



35 x 445 x 543 mm

1 FF1A212LM

1-100-08-2-2	
1-210-08-2-2	
1-230-08-2-2	
3734-2, 3734-3, 3734-4, 3734-5, 3734-6, 3734-8	
3735-4-120	
3740-150, 3740-250	
426TOR9	
481-400	
BE-8986	
MTC-5-16-C1	
2446	
3625N-32	

Fit&Go 3/3 sats med ERGO™ skruvmejslar och u-ringnycklar i lasermärkt skumplastinlägg – 31 delar



FF1A215LM



40 x 445 x 543 mm

1 FF1A215LM

111M-10, 111M-11, 111M-12, 111M-13, 111M-14, 111M-15, 111M-16, 111M-17, 111M-18, 111M-19, 111M-20, 111M-21, 111M-22, 111M-24, 111M-8, 111M-9	
BE-8910, BE-8915, BE-8920, BE-8925, BE-8930	
BE-8020, BE-8040	
BE-8155	
BE-8355	
BE-8602	
BE-8611, BE-8621	
BE-8811, BE-8821	
BE-8802	

Fit&Go 3/3 sats med hammare, kapverktyg, filar och insexnycklar i lasermärkt skumplastinlägg – 36 delar



FF1A216LM



40 x 445 x 543 mm

1 FF1A216LM

1-100-08-2-2	
1-210-08-2-2	
1-230-08-2-2	
3734-3, 3734-4, 3734-5	
3735-4-120	
481-400	
BE-8986	
BE-9770	
S4RM-8-11, S4RM-12-15, S4RM-16-19	
KB18-01	
KSBG18-10DISPEN	
MTG-3-16	
WR2-MM	
3740-200	
317	

Fit&Go 3/3 sats med spärrkombinycklar, ledad nyckel och insexnycklar i lasermärkt skumplastinlägg – 42 delar



FF1A221LM



40 x 445 x 543 mm

1 FF1A221LM

1RM-10, 1RM-11, 1RM-12, 1RM-13, 1RM-14, 1RM-17, 1RM-19, 1RM-8	
2681	
4040M-10-11, 4040M-12-13, 4040M-14-15, 4040M-16-17, 4040M-18-19, 4040M-8-9	
8045LVDE	
806-1-1	
808050	
808050S	
9715-14-250	
BE-9575	
BE-9770	

Fit&Go 3/3 sats med ERGO™ skruvmejslar, skjutmått, bitssats och 1/2" krafthylsor i lasermärkt skumplastinlägg – 65 delar



FF1A222LM



45 x 445 x 543 mm

1 FF1A222LM

BE-7805, BE-7806, BE-7807, BE-7808, BE-7809, BE-7810, BE-7811, BE-7813, BE-7855	
D/S14	
K8160D-1, K8160D-2	
K8167S	
BE-8135TB, BE-8145TB, BE-8150TB, BE-8155TB	
BE-8610TB, BE-8620TB, BE-8623TB	
1150-1/2H/P	
59/S31B	

Fit&Go 3/3 sats med hammare och kapverktyg samt slangklämstänger i lasermärkt skumplastinlägg – 26 delar



FF1A224LM



40 x 445 x 543 mm

1 FF1A224LM

1435/8	
319	
3625S-35	
3734S/6	
3735-5-150	
3740-200	
3750	
3906-300-24-2P	
479-16	
KBFU-01	
BE256P3	

Fit&Go 3/3 sats med sylar, krokar, skrapa, magnetiskt upplockningsverktyg och Torx-bits i lasermärkt skumplastinlägg – 28 delar



FF1A225LM



40 x 445 x 543 mm

1 FF1A225LM

2487	
2535F1	
2633/S4	
2485	
782-U	
BE5049T	
BE66152	
2484-45	
5515T-52	

Fit&Go 3/3 sats med spårringstänger och nycklar i skumplastinlägg – 17 delar



FF1A230



40 x 445 x 543 mm

1 FF1A230

1RM-9, 1RM-8, 1RM-11, 1RM-10, 1RM-13, 1RM-12, 1RM-15, 1RM-14, 1RM-17, 1RM-16, 1RM-19, 1RM-18	
28-29/S4	
8072 C	

Fit&Go 3/3 sats med nycklar, tänger och hylsor i lasermärkt skumplastinlägg – 45 delar



FF1A29NB



50 x 445 x 543 mm 6.26 kg

1 FF1A29NB

111M-6, 111M-7, 111M-8, 111M-9, 111M-13, 111M-12, 111M-11, 111M-10, 111M-24, 111M-22, 111M-17, 111M-16, 111M-15, 111M-14, 111M-21, 111M-19, 111M-18	
8071 IP	
2470 G-160	
2971G-250	
2171G-160	
8150SL	
SBS83-10, SBS83-5	
SBS87S	
SBS85	
7800SM-27, 7800SM-22, 7800SM-23, 7800SM-24, 7800SM-18, 7800SM-19, 7800SM-20, 7800SM-21, 7800SM-14, 7800SM-15, 7800SM-16, 7800SM-17, 7800SM-10, 7800SM-11, 7800SM-12, 7800SM-13, 7800SM-30, 7800SM-32	

Fit&Go 3/3 sats med ERGO™ skruvmejslar, spärrhandtag, hylsor och bitssats i lasermärkt skumplastinlägg – 22 delar

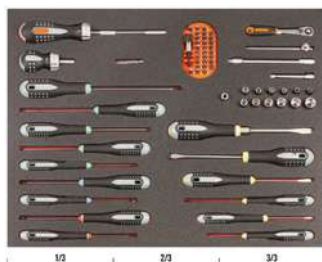

FF1A30NB



35 x 445 x 543 mm 2.8 kg

1 FF1A30NB

BE-8020, BE-8030, BE-8040	
BE-8150, BE-8155	
BE-8160	
BE-8611, BE-8621	
BE-8811, BE-8821	
BE-8910, BE-8915, BE-8920, BE-8925, BE-8930	
808050S	
808050	
6972H	
K6650-1/4-1P	
6950SL	
59S/31-1	
SBS64	
SB6963	
SBS60-4, SBS60-11, SBS60-12, SBS60-13, SBS60-7, SBS60-8, SBS60-9, SBS60-10, SBS60-4.5, SBS60-5, SBS60-5.5, SBS60-6	

Fit&Go 3/3 sats med hammare, kapverktyg, filar och insexnycklar i lasermärkt skumplastinlägg – 28 delar



FF1A31NB



45 x 445 x 543 mm 2.69 kg

1 FF1A31NB

317	
1-100-08-1-2	
1-210-08-1-2	
1-230-08-1-2	
MTB-3-16	
3625W-35	
481-300	
782-U	
BE-9770	
KG09-01	
KSBG09-10DISPEN	

Fit&Go 3/3 sats med hammare, kapverktyg, tänger och måttband i skumplastinlägg – 25 delar



FF1A82



43 x 445 x 543 mm

1 FF1A82

3734S/6	
479-16	
3625W-35	
MTG-3-16	
KB18-01	
KSBG18-10DISPEN	
2101G-180IP	
2678 G-180	
2470 G-200	
720031	
8224 IP	



VERKTYGSSATSER FÖR SPECIALAPPLIKATIONER

Verktygsvagn 53" med verktyg för allroundarbete – 488 delar



XXL



986 x 501 x 1430 mm



1 XXL

1476KXXL7BK	
2058-BR	
6700SM-10, 6700SM-11, 6700SM-12, 6700SM-13, 6700SM-14, 6700SM-4, 6700SM-4.5, 6700SM-5, 6700SM-5.5, 6700SM-6, 6700SM-7, 6700SM-8, 6700SM-9	
6700TORX-E10, 6700TORX-E4, 6700TORX-E5, 6700TORX-E6, 6700TORX-E7, 6700TORX-E8	
6950SL	
6954	
6956	
6960, 6962, 6962L	
6963	
6966	
696EX-11	
6972H	
7400SM-10, 7400SM-11, 7400SM-12, 7400SM-13, 7400SM-14, 7400SM-15, 7400SM-16, 7400SM-17, 7400SM-18, 7400SM-19, 7400SM-20, 7400SM-21, 7400SM-22, 7400SM-6, 7400SM-7, 7400SM-8, 7400SM-9	
7400TORX-E10, 7400TORX-E11, 7400TORX-E12, 7400TORX-E14, 7400TORX-E16, 7400TORX-E18, 7400TORX-E8	
7406ZZ-16, 7406ZZ-21	
7409BH-10, 7409BH-4, 7409BH-5, 7409BH-6, 7409BH-8	
7409F-10, 7409F-6.5, 7409F-8	
7409TORX-R-T27, 7409TORX-R-T30, 7409TORX-R-T40, 7409TORX-R-T45, 7409TORX-R-T50	
7409TORX-T25, 7409TORX-T27, 7409TORX-T30, 7409TORX-T40, 7409TORX-T45, 7409TORX-T50	
7750SL	
7757	
7758	
7759	
7760	
7761-W	
7764	

7765	
7766	
7767	
776EX-11	
7800SM-10, 7800SM-11, 7800SM-12, 7800SM-13, 7800SM-14, 7800SM-15, 7800SM-16, 7800SM-17, 7800SM-18, 7800SM-19, 7800SM-20, 7800SM-21, 7800SM-22, 7800SM-23, 7800SM-24, 7800SM-25, 7800SM-26, 7800SM-27, 7800SM-28, 7800SM-29, 7800SM-30, 7800SM-32, 7800SM-33, 7800SM-34, 7800SM-36, 7800SM-8, 7800SM-9	
7800TORX-E10, 7800TORX-E11, 7800TORX-E12, 7800TORX-E14, 7800TORX-E16, 7800TORX-E18, 7800TORX-E20, 7800TORX-E24, 7800TORX-E8	
7805SM-10, 7805SM-12, 7805SM-13, 7805SM-14, 7805SM-15, 7805SM-16, 7805SM-17, 7805SM-18, 7805SM-19, 7805SM-20, 7805SM-21, 7805SM-22, 7805SM-23, 7805SM-24, 7805SM-25, 7805SM-26, 7805SM-27, 7805SM-28, 7805SM-29, 7805SM-30, 7805SM-32	
7809M-10, 7809M-12, 7809M-14, 7809M-4, 7809M-5, 7809M-6, 7809M-7, 7809M-8	
7809M-10-140, 7809M-5-100, 7809M-6-100, 7809M-7-100, 7809M-8-120	
7809XZN-10, 7809XZN-10-100, 7809XZN-12, 7809XZN-12-100, 7809XZN-14, 7809XZN-14-100, 7809XZN-16, 7809XZN-18, 7809XZN-6, 7809XZN-8, 7809XZN-8-100	
8150SL	
8160-3, 8160-5	
8160W-10	
8164-1/2	
8171	
8166	
8167	
A6800DM-10, A6800DM-11, A6800DM-12, A6800DM-13, A6800DM-14, A6800DM-4, A6800DM-5, A6800DM-5.5, A6800DM-6, A6800DM-7, A6800DM-8, A6800DM-9	
A7402DM-10, A7402DM-11, A7402DM-12, A7402DM-13, A7402DM-14, A7402DM-15, A7402DM-16, A7402DM-17, A7402DM-18, A7402DM-19, A7402DM-21, A7402DM-7, A7402DM-8, A7402DM-9	
K6625-1/4-1P	
K6650-1/2-1P, K6650-1/4-1P, K6650-3/8-1P	
2101G-160	
2421 G-140IP, 2421 G-180	
2427 G-200	
2430 G-160	
2628 G-180	
2800-140, 2800-180, 2800-225	
2890-125, 2890-180, 2890-210	
2900-140, 2900-180, 2900-215	
2951-250	
2952-165	
2990-140, 2990-180, 2990-200	
3416 A	
4130	
7224	
BE256-155, BE256-178, BE256-250	

BLTS7P	
CR W 01	
1150-1/2H/P	
1544	
2633/S4x 4	
59/S100BCx 100	
806-1-3	
808050L	
BE-7607	
BE-8020L	
BE-8155TB, BE-8256TB, BE-8258TB	
BE-8355	
BE-8600	
BE-8602	
BE-8610TB, BE-8620TB, BE-8623TB, BE-8624TB	
BE-8802	
BE-8810TB, BE-8820TB, BE-8823TB, BE-8824TB	
BE-8907, BE-8908, BE-8909, BE-8910, BE-8915, BE-8920, BE-8925, BE-8927, BE-8930, BE-8940	
BE-8986	
BE-9770x 9	
BE-9785x 13	
MTC-5-16-C1	
1-170-08-2-2	
1-210-08-2-2	
1-230-08-2-2	
208	
2484T-30, 2484T-60	
2509	
2535L	
319	
3625N-32	
3681-16	
3734-2, 3734-3, 3734-4, 3734-5, 3734-6, 3734-8	
3735-4-120, 3735-5-120	
3740-150, 3740-250	
3906-300-32-5Px 5	
479-08	
481-1000, 481-400	
5515T	
782-U	
KBGU-5P-DISPENx 5	
KERU-01	
111M-10, 111M-11, 111M-12, 111M-13, 111M-14, 111M-15, 111M-16, 111M-17, 111M-18, 111M-19, 111M-20, 111M-21, 111M-22, 111M-23, 111M-24, 111M-25, 111M-26, 111M-27, 111M-28, 111M-29, 111M-30, 111M-32, 111M-33, 111M-34, 111M-36, 111M-6, 111M-7, 111M-8, 111M-9	
1RM-10, 1RM-11, 1RM-12, 1RM-13, 1RM-14, 1RM-15, 1RM-16, 1RM-17, 1RM-18, 1RM-19, 1RM-21, 1RM-22, 1RM-24, 1RM-27, 1RM-30, 1RM-32, 1RM-6, 1RM-7, 1RM-8, 1RM-9	
4040M-10-11, 4040M-12-13, 4040M-14-15, 4040M-16-17, 4040M-18-19, 4040M-8-9	
8069, 8071, 8073	

Allroundverktøygssats i verktøygsvagn – 758 delar



MONSTER



1370 x 501 x 1100 mm



1 MONSTER

FF1BSET-MONSTER

Allroundverktøygssats i verktøygsvagn – 346 delar



LARGE



952 x 510 x 782 mm



1 LARGE

FF1ASET-LARGE

Allroundverktøygssats i verktøygsvagn – 560 delar



XLARGE



1360 x 510 x 820 mm



1 XLARGE

FF1ASET-XLARGE

Allroundverktøygssats i verktøygsvagn – 158 delar



BASIC1



952 x 510 x 782 mm



1 BASIC

FF1ASET-BASIC

Allroundverktøygssats i verktøygsvagn – 210 delar



1475KXL6CBK-FF5



986 x 501 x 1100 mm



1 1475KXL6CBK-FF5

FF1A48



FF1A49



FF1A50



FF1A51



FF1A213



FF1A53



Allroundverktøygssats i verktøygsvagn – 187 delar



1475KXL6CBK-FF6



986 x 501 x 1100 mm



1 1475KXL6CBK-FF6

FF1A65



FF1A66



FF1A67



FF1A68



FF1A194



Allroundverktygssats på metallvägg, 1 m
– 768 delar



BAHCO-1MW-1



2250 x 520 x 1025 mm

1 BAHCO-1MW-1

111M-8x 10, 111M-10x 10, 111M-12x 10,
111M-11x 10, 111M-14x 10, 111M-13x 10,
111M-16x 10, 111M-17x 10, 111M-19x 10,
111M-22x 5, 111M-24x 5, 111M-27x 5,
111M-30x 5, 111M-32x 5

8072 Cx 5, 8073 Cx 5

2101G-160x 5

21HDG-180x 5

2628 G-200x 5

2430 G-200x 5

2427 G-200x 5

2223 G-150x 5

8224x 5

2101S-160x 3

2628 S-180x 3

2430 S-200x 3

2997-300x 5

28M-8x 5, 28M-10x 5, 28M-27x 3,
28M-30x 2, 28M-32x 2, 28M-20x 3,
28M-19x 3, 28M-22x 3, 28M-24x 3,
28M-12x 5, 28M-11x 5, 28M-14x 5,
28M-13x 5, 28M-16x 5, 28M-17x 5

S240x 4

B190.055.125x 10, B190.100.200x 10,
B190.065.150x 10

B191.030.075x 10, B191.040.100x 10

B192.001.100x 10, B192.003.150x 10,
B192.002.125x 10

B193.001.100x 10, B193.002.125x 10

B196.040.100x 10, B196.055.125x 10,
B196.030.100x 10

B197.002.100x 10, B197.001.080x 10

806-1-1x 6

BE-9578x 4

BE-9678x 4

BE-9575x 4

B219.017x 4

B220.007x 4

482-40x 6

483-25x 6

3625S-35x 6

319x 5

3906-300-24-100x 100

MEE-SIGN-CARR-B

MEE-1S2L-B-I

MEE-ACCSS-005x 60

MEE-ACCSS-004x 10

MEE-ACCSS-009x 20

MEE-ACCSS-011x 3

1 500 mm verktygsskåp med jalusi och
allroundverktygssats – 110 delar



1495CS15TS1



900 x 170 x 1500 mm

1 1495CS15TS1

1495CS15

981001100

1495CS-AC1

1495TP-AC10

1 800 mm verktygsskåp med jalusi och
allroundverktygssats – 110 delar



1495CS18TS1



900 x 170 x 1800 mm

1 1495CS18TS1

1495CS18

981001100

1495CS-AC1

1495TP-AC10

Verktygsskåp med 2 dörrar och
allroundverktygssats – 110 delar



1495CD60TS1



900 x 250 x 602 mm

1 1495CD60TS1

1495CD60

981001100

1495CD-AC1

1495TP-AC10

Robust hård väska med ett grundsortiment
av verktyg-162 delar



4750RCWD4FF1



453 x 340 x 575 mm

1 4750RCWD4FF1

4750RCWD4

6700SM-10, 6700SM-9, 6700SM-12,
6700SM-11, 6700SM-6, 6700SM-8,
6700SM-7, 6700SM-13

A6800DM-13, A6800DM-12,
A6800DM-9, A6800DM-8, A6800DM-11,
A6800DM-10, A6800DM-5.5,
A6800DM-7, A6800DM-6

6709M-3, 6709M-8, 6709M-6, 6709M-5,
6709M-4

6709PH-1, 6709PH-3, 6709PH-2

6709TORX-T30, 6709TORX-T27,
6709TORX-T40, 6709TORX-T15,
6709TORX-T10, 6709TORX-T25,
6709TORX-T20, 6709TORX-T9,
6709TORX-T8

6950SL

6954

6956

6958

6960, 6962, 6962L

6966

6972H

7764

7800SM-25, 7800SM-24, 7800SM-27,
7800SM-26, 7800SM-21, 7800SM-23,
7800SM-22, 7800SM-17, 7800SM-16,
7800SM-19, 7800SM-18, 7800SM-13,
7800SM-12, 7800SM-15, 7800SM-14,
7800SM-9, 7800SM-8, 7800SM-11,
7800SM-10, 7800SM-28, 7800SM-32,
7800SM-30

7809TORX-T45, 7809TORX-T25,
7809TORX-T50, 7809TORX-T30,
7809TORX-T27, 7809TORX-T40

8150RN-1/2

111M-30, 111M-32, 111M-27, 111M-29,
111M-24, 111M-19, 111M-18, 111M-21,
111M-15, 111M-14, 111M-17, 111M-16,
111M-11, 111M-10, 111M-13, 111M-12,
111M-7, 111M-6, 111M-9, 111M-8

9070C

BE-9770

2058-BR

1544

MTB-3-16

2101G-160IP

2427 G-200 IP

2430 G-200 IP

2628 G-160IP

8224 IP

1150-1/2H/P

5515T-52

2820EF2

481-300

3625W-35

3734-3, 3734-5, 3734-8

3735-4-120

1177-SCRIBE

8160-3, 8160-5, 8160-10

8166

8157-15

8154-11

Sats med universalverktyg i metalllåda – 194 delar



4750RCHDW01FF3

250 x 345 x 545 mm 1 4750RCHDW01FF3

- 4750RCHDW01
- FF2B12
- FF2B13
- FF2B14
- FF2B15
- FF2B16

Sats med isolerade verktyg, i extra kraftig väska – 79 delar



4750RCHDW02RF1V

290 x 480 x 630 mm 1 4750RCHDW02RF1V

- 4750RCHDW02RED
- 8150-1/2V
- BMMTRMS1
- 28MV-10, 28MV-15, 28MV-16, 28MV-21, 28MV-22, 28MV-12, 28MV-13
- 2101S-160, 2101S-180
- 2101S-200
- 2223 S-150
- 2820VDE
- BE-8040S, BE-8050S, BE-8010S, BE-8065S
- BE-8703S, BE-8704S, BE-8725S, BE-8705S, BE-8706S, BE-8708S
- BE-8910S, BE-8915S, BE-8920S, BE-8925S, BE-8930S
- SC127V
- 1999MV-5, 1999MV-6, 1999MV-7, 1999MV-8, 1999MV-9, 1999MV-10, 1999MV-12
- 2430V-160, 2430V-200
- 2678V-180, 2678V-160, 2678V-200
- 3416 A
- 806-1-1
- BE-8600S, BE-8610S, BE-8620S, BE-8630S, BE-8640S
- 527V-160
- 2427V-200
- 2MV-10, 2MV-11, 2MV-12, 2MV-13, 2MV-14, 2MV-15, 2MV-16, 2MV-17, 2MV-18, 2MV-19
- WR1-MM
- 7800DMV-8, 7800DMV-10, 7800DMV-11, 7800DMV-12, 7800DMV-13, 7800DMV-14, 7800DMV-15, 7800DMV-16, 7800DMV-17, 7800DMV-18, 7800DMV-19, 7800DMV-20, 7800DMV-21, 7800DMV-22
- 2820VPC
- 8162-1/2V
- 7224S

Allroundverktygssats i verktyglåda i metall – 193 delar



1483KHD3RB-FF3

335 x 260 x 565 mm 1 1483KHD3RB-FF3

- 1483KHD3RB
- FF3A09
- FF3A10
- FF3A11
- FF3A12

Allroundverktygssats i verktyglåda i metall – 146 delar



1483KHD3RB-FF4

335 x 260 x 565 mm 1 1483KHD3RB-FF4

- 1483KHD3RB
- FF3A10
- FF3A11
- FF3A12
- FF3A13



Allroundverktygssats i verktygslåda i Aluminium, 145 delar



4750ALC01FF1



160 x 320 x 450 mm 1 4750ALC01FF1

111M-14, 111M-15, 111M-16, 111M-17, 111M-18, 111M-19, 111M-8, 111M-9, 111M-10, 111M-11, 111M-12, 111M-13	
BE-9678	
8072 C IP	
224 D	
2171G-160	
2339-220IP	
2678 G-180	
2470 G-160	
SCB140	
B191.030.075, B191.040.125	
B190.055.125, B190.065.150	
B192.001.100, B192.002.125	
806-1-1	
482F-30	
MTB-5-25	
208	
KB18-01	
808050TS	
59S/0.6-4.5-3P, 59S/1.0-5.5-3P, 59S/1.2-6.5-3P	
59S/PH1-3P, 59S/PH2-3P, 59S/PH3-3P, 59S/PH0-3P	
59S/PH2G-3P	
59S/PZ2-3P, 59S/PZ3-3P, 59S/PZ0-3P, 59S/PZ1-3P	
66IM/T20C-2P, 66IM/T15C-2P, 66IM/T10C-2P, 66IM/T40C-2P, 66IM/T30C-2P, 66IM/T27C-2P, 66IM/T25C-2P	
59S/H1.5-3P, 59S/H3-3P, 59S/H2.5-3P, 59S/H4-3P, 59S/H5-3P, 59S/H2-3P, 59S/H6-3P, 59S/H8-3P	
KM6750-11, KM6750-6, KM6750-7, KM6750-8, KM6750-10, KM6750-13	
K6650-1/4-1P	
KM653-1P	
KSBG18-10DISPEN	
700-1.5-50, 700-1.2-50, 700-1-50, 700-1.8-50	
701-00-50, 701-0-50	

3906-250-24-5P, 3906-250-32-5P	
3735N-4-120	
3734N-2-150, 3734N-4-150, 3734N-6-150	
SBS60-9, SBS60-10, SBS60-11, SBS60-12, SBS60-13, SBS60-4, SBS60-4.5, SBS60-5, SBS60-5.5, SBS60-6, SBS60-7, SBS60-8	
SBS61	
SB6963	
SBS64	
8160-10, 8160-5	
8158-10	
7800SM-20, 7800SM-21, 7800SM-22, 7800SM-23, 7800SM-24, 7800SM-27, 7800SM-12, 7800SM-13, 7800SM-14, 7800SM-15, 7800SM-16, 7800SM-17, 7800SM-18, 7800SM-19, 7800SM-10, 7800SM-11, 7800SM-30, 7800SM-32	
SBS81	
8166	
7772H	

Allroundverktygssats i läderväska-32 delar



982000320

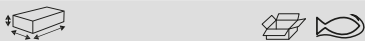

280 x 200 x 435 mm 1 982000320

4750-FOLTC-1	
2101D-160IP	
224 D	
2630D-180	
2430 D-160 IP	
8071 C IP	
483-20	
6M/8C	
541D-180	
2951-180	
B191.030.075, B191.040.100	
B190.100.200, B190.065.150	
B192.001.100, B192.002.125	
SC127	
2820EF2	
BE-9777	
MTB-3-16	

Väska med grundsats med verktyg-32 delar



983000320



162 x 380 x 435 mm 1 983000320

4750RC01	
2101D-160IP	
224 D	
2630D-180	
2430 D-160 IP	
8071 C IP	
483-20	
541D-180	
2951-180	
6M/8C	
B191.030.075, B191.040.100	
B190.100.200, B190.065.125	
B192.001.100, B192.002.125	
SC127	
2820EF2	
BE-9777	
MTB-3-16	

Hård väska med grundsats med verktyg-32 delar



983100320



210 x 415 x 460 mm 1 983100320

4750RC02	
2101D-160IP	
224 D	
2430 D-160 IP	
8071 C IP	
483-20	
541D-180	
2951-180	
B191.030.075, B191.040.100	
B190.100.200, B190.065.150	
B192.001.100, B192.002.125	
SC127	
2820EF2	
BE-9777	
MTB-3-16	
2630DC-180IP	
6M/8C	

Grundsats med verktyg i hård väska med hjul-32 delar



984010320

255 x 390 x 465 mm 1 984010320

4750RCW01	
2101D-160IP	
224 D	
2630D-180	
2430 D-160 IP	
6M/8C	
8071 C IP	
483-20	
541D-180	
2951-180	
B191.030.075, B191.040.100	
B190.100.200, B190.065.150	
B192.001.100, B192.002.125	
SC127	
2820EF2	
BE-9777	
MTB-3-16	

Allroundverktygssats i läderväska-34 delar



982000350

280 x 200 x 440 mm 1 982000350

4750-FOLTC-1	
2101GC-160IP	
2630GC-180IP	
2900-180	
2800-180	
1998M/10T	
8072 C IP	
2951-250	
B190.100.200, B190.065.150, B190.040.100	
B192.001.100, B192.002.125	
SC127	
6M/8C	
479-16	
2430 GC-200 IP	
1-110-08-2-2	
6224	

Litet textiletui med allroundverktygssats - 36 delar



4750FB5ATS001

275 mm 170 mm 1 4750FB5ATS001

4750FB5A	
2058/S26	
808050	
8070	
2101G-160	
2628 G-180	

Verktygssats i etui med blyxtlås-7 delar



9848

50 x 275 x 330 mm 1 9848

8160		
7890		
8070		
BE-8020, BE-8040		
BE-8610		
TL AA-SA-SL		

Textilmapp med verktyg i skumplastinlägg, 51 delar



4750FB5BFF1

62 x 275 x 330 mm 1 4750FB5BFF1

4750FB5B	
808050P	
MTB-5-25	
2101G-160	
2628 G-180	
BE-9578	
9070	
59/S31B	



Allroundverktygssats i verktyglåda i metall – 37 delar



4750PTB65TS5



285 x 300 x 650 mm



1 4750PTB65TS5

2430 D-140 IP



2630D-160

MT-TS-3



9572



BE-9884



2446



SL25



427-16



Allroundverktygssats i skumplastinlägg i verktyglåda i metall – 69 delar



3149-ORFF1



220 x 220 x 560 mm



1 3149-ORFF1

111M-19, 111M-18, 111M-17, 111M-16, 111M-15, 111M-14, 111M-13, 111M-12, 111M-11, 111M-10, 111M-8, 111M-9



2953-250



224 D



2171G-160



2470 G-200



BE-9770



611-3.5-75, 611-5.5-125, 611-6.5-150



613-3-100, 613-4-125



615-2-25, 615-1-100, 615-2-125, 615-3-150



KBSK-01



MTG-5-19-E



482-30



3625W-28



3745-150



3740-150



3734-3, 3734-5



3735-5-120



3149-OR



2678 G-200



8160-10, 8160-5



8158-10



SBS81



8166



7772H



7800SM-15, 7800SM-16, 7800SM-13, 7800SM-14, 7800SM-19, 7800SM-20, 7800SM-17, 7800SM-18, 7800SM-23, 7800SM-24, 7800SM-21, 7800SM-22, 7800SM-27, 7800SM-32, 7800SM-30, 7800SM-11, 7800SM-12, 7800SM-10



Allroundverktygssats i verktyglåda i metall – 69 delar



3149-ORTS1



220 x 220 x 560 mm



1 3149-ORTS1

111M-19, 111M-18, 111M-17, 111M-16, 111M-15, 111M-14, 111M-13, 111M-12, 111M-11, 111M-10, 111M-9, 111M-8



S240



2953-250



224 D



2171G-160



2678 G-200



2470 G-200



BE-9770



611-3.5-75, 611-5.5-125, 611-6.5-150



613-3-100, 613-4-125



615-2-25, 615-1-100, 615-2-125, 615-3-150



KBSK-01



MTG-5-19-E



482-30



3625W-28



3745-150



3740-150



3734-3, 3734-5



3735-5-120



3149-OR



Allroundverktygssats i skumplastinlägg för 11 lådor – 758 delar



FF1BSET-MONSTER



40 x 445 x 880 mm



1 FF1BSET-MONSTER

FF1B01LM



FF1B02LM



FF1B03LM



FF1B04LM



FF1B05LM



FF1B10LM



FF1B11LM



FF1B08LM



FF1B09LM



FF1B06LM



FF1B07LM



Allroundverktygssats i skumplastinlägg för 12 lådor – 560 delar



FF1ASET-XLARGE



40 x 543 x 445 mm



1 FF1ASET-XLARGE

FF1A195LM



FF1A196LM



FF1A197LM



FF1A198LM



FF1A199LM



FF1A200LM	
FF1A201LM	
FF1A202LM	
FF1A203LM	
FF1A204LM	
FF1A205LM	
FF1A206LM	

Allroundverktygssats i skumplastinlägg för 6 lådor – 346 delar



FF1ASET-LARGE

40 x 543 x 445 mm 1 FF1ASET-LARGE

FF1A207LM	
FF1A208LM	
FF1A209LM	
FF1A210LM	
FF1A211LM	
FF1A212LM	

Allroundverktygssats i skumplastinlägg för 3 lådor – 158 delar



FF1ASET-BASIC

40 x 543 x 445 mm 1 FF1ASET-BASIC

FF1A214LM	
FF1A215LM	
FF1A216LM	

Skumplastinlägg för 40" vagn, 1/4" hylsnyckelsatser, metrisk och tum-skala – 141 delar



FF1B01LM

35 x 445 x 880 mm 1 FF1B01LM

6700SM-10, 6700SM-11, 6700SM-12, 6700SM-13, 6700SM-14, 6700SM-4, 6700SM-4.5, 6700SM-5, 6700SM-5.5, 6700SM-6, 6700SM-7, 6700SM-8, 6700SM-9		
6700SZ-1/2, 6700SZ-1/8, 6700SZ-9/16, 6700SZ-1/4, 6700SZ-11/32, 6700SZ-3/16, 6700SZ-3/8, 6700SZ-5/16, 6700SZ-7/16, 6700SZ-7/32, 6700SZ-9/32, 6700SZ-5/32		
6700TORX-E4, 6700TORX-E5, 6700TORX-E6, 6700TORX-E7, 6700TORX-E8, 6700TORX-E10		
6950SL		
6962L, 6960, 6961		
6972H		
7400SM-10, 7400SM-11, 7400SM-12, 7400SM-13, 7400SM-14, 7400SM-15, 7400SM-16, 7400SM-17, 7400SM-18, 7400SM-19, 7400SM-20, 7400SM-21, 7400SM-22, 7400SM-6, 7400SM-7, 7400SM-8, 7400SM-9		
7400TORX-E10, 7400TORX-E11, 7400TORX-E12, 7400TORX-E14, 7400TORX-E16, 7400TORX-E18		
7406ZZ-16, 7406ZZ-21		
7409TORX-R-T27, 7409TORX-R-T30, 7409TORX-R-T40, 7409TORX-R-T45, 7409TORX-R-T50		
7409TORX-T25, 7409TORX-T27, 7409TORX-T30, 7409TORX-T40, 7409TORX-T45, 7409TORX-T50		
7750SL		
2058-BR		
8164-1/2		
A6800DM-10, A6800DM-12, A6800DM-13, A6800DM-4, A6800DM-5, A6800DM-5.5, A6800DM-6, A6800DM-7, A6800DM-8, A6800DM-9, A6800DM-11, A6800DM-14		
A6800DZ-9/16, A6800DZ-1/2, A6800DZ-1/4, A6800DZ-11/32, A6800DZ-3/16, A6800DZ-3/8, A6800DZ-5/16, A6800DZ-7/16, A6800DZ-7/32, A6800DZ-9/32		
A7400DZ-1/2, A7400DZ-11/16, A7400DZ-3/4, A7400DZ-3/8, A7400DZ-5/8, A7400DZ-7/16, A7400DZ-17/32, A7400DZ-9/16, A7400DZ-19/32, A7400DZ-13/16, A7400DZ-7/8, A7400DZ-1/4, A7400DZ-5/16		
K6650-1/4-1P, K6650-3/8-1P		
K6625-1/4-1P		
6954		
6956		

6963		
6966		
7760, 7761, 7762		
7764		
7765		
7766		
7409BH-4, 7409BH-5, 7409BH-6, 7409BH-8, 7409BH-10		
A7402DM-10, A7402DM-11, A7402DM-12, A7402DM-13, A7402DM-14, A7402DM-15, A7402DM-16, A7402DM-17, A7402DM-18, A7402DM-19, A7402DM-8, A7402DM-9		
7756		

Skumplastinlägg för 40" vagn, 1/2" hylsnyckelsatser, metrisk och tum-skala – 76 delar



FF1B02LM

40 x 445 x 880 mm 1 FF1B02LM

7800DM-10, 7800DM-11, 7800DM-12, 7800DM-13, 7800DM-14, 7800DM-15, 7800DM-16, 7800DM-17, 7800DM-18, 7800DM-19, 7800DM-20, 7800DM-21, 7800DM-22, 7800DM-24, 7800DM-27, 7800DM-30, 7800DM-32, 7800DM-34, 7800DM-36		
7800DZ-1, 7800DZ-1.1/16, 7800DZ-1.1/4, 7800DZ-1.1/8, 7800DZ-1.3/16, 7800DZ-1/2, 7800DZ-11/16, 7800DZ-13/16, 7800DZ-15/16, 7800DZ-25/32, 7800DZ-3/4, 7800DZ-3/8, 7800DZ-5/8, 7800DZ-7/16, 7800DZ-7/8, 7800DZ-9/16, 7800DZ-19/32		
7809M-10, 7809M-12, 7809M-14, 7809M-4, 7809M-5, 7809M-6, 7809M-7, 7809M-8		
8150SL		
SBS87		
K7801M-13, K7801M-15, K7801M-16, K7801M-17, K7801M-18, K7801M-19, K7801M-21, K7801M-22, K7801M-24		
K8160D-2		
K7806M-13, K7806M-14, K7806M-16, K7806M-17, K7806M-18, K7806M-19, K7806M-21, K7806M-22, K7806M-24		
7809M-5-100, 7809M-6-100, 7809M-7-100, 7809M-8-120, 7809M-10-140		
K6650-1/2-1P		
8160-3, 8160-5, 8160-10		
8171		
8166		



Skumplastinlägg för 40" vagn, satser med u-ringnycklar och spårnycklar – 36 delar



FF1B03LM



35 x 445 x 880 mm

1 FF1B03LM

111M-10, 111M-11, 111M-12, 111M-13, 111M-14, 111M-15, 111M-16, 111M-17, 111M-18, 111M-19, 111M-20, 111M-21, 111M-22, 111M-24, 111M-27, 111M-30, 111M-32, 111M-34, 111M-8, 111M-9

1RM-10, 1RM-11, 1RM-12, 1RM-13, 1RM-14, 1RM-15, 1RM-16, 1RM-17, 1RM-18, 1RM-19, 1RM-21, 1RM-22, 1RM-24, 1RM-27, 1RM-8, 1RM-9

Skumplastinlägg för 40" vagn, u-ringnycklar, ledhylsnycklar och teleskopisk spegel – 26 delar



FF1B04LM



35 x 445 x 880 mm

1 FF1B04LM

1RM-30, 1RM-32

111Z-1, 111Z-1.1/16, 111Z-1.1/4, 111Z-1.1/8, 111Z-1/2, 111Z-11/16, 111Z-13/16, 111Z-15/16, 111Z-3/4, 111Z-3/8, 111Z-5/16, 111Z-5/8, 111Z-7/16, 111Z-7/8, 111Z-9/16

4040M-10-11, 4040M-12-13, 4040M-14-15, 4040M-16-17, 4040M-18-19, 4040M-8-9

5515T

BLTS7P

2535L

Skumplastinlägg för 40" vagn med tänger, småtänger, nycklar och skjutmått – 32 delar



FF1B05LM



35 x 445 x 880 mm

1 FF1B05LM

1150-1/2H/P

1520 G

1620

2101S-160

21HDG-160

2223 S-150

2430 G-160

2430 S-200

2628 G-180

2628 S-180

2744

426TOR9

KBGU-10P-DISPEN

KERU-01

MTC-5-16-C1

8224

9029, 9031

806-1-3

C3330R

C3530

C3230

C3640

Skumplastinlägg för 40" vagn, satser med isolerade ERGO™ skruvmejslar och precisionsskruvmejslar – 88 delar



FF1B06LM



40 x 445 x 880 mm

1 FF1B06LM

700-2.5-50, 700-2-50, 700-3-50

701-00-50, 701-0-50, 701-1-75

703-10-50, 703-15-75, 703-6-50, 703-7-50, 703-8-50, 703-9-50

808050L

BE-8010S

BE-8020, BE-8040

BE-8040SL, BE-8050SL

BE-8150, BE-8155, BE-8256

BE-8355

BE-8600, BE-8611, BE-8621, BE-8623

BE-8600S

BE-8602

BE-8610SL, BE-8620SL

BE-8702, BE-8725

BE-8820SL

BE-8870

BE-8975B

BE-9777B

BE-9787

BE-9770

BE-9785

Skumplastinlägg för 40" vagn, sats med isolerade ERGO™ skruvmejslar och bitssats – 169 delar



FF1B07LM



40 x 445 x 880 mm

1 FF1B07LM

BE-8256TB, BE-8258TB

BE-8620TB, BE-8623TB

59/S100BC

7455-200

BE-8907, BE-8908, BE-8909, BE-8910, BE-8915, BE-8920, BE-8925, BE-8927, BE-8930, BE-8940

BE-8811, BE-8821

BE-8830

BE-8802

BE5049T

BE-7607

Skumplastinlägg för 40" vagn, satser med hammare, filar och avdragare – 45 delar



FF1B08LM



40 x 445 x 880 mm



1 FF1B08LM

1-100-08-2-2		
1-170-08-2-2		
1-210-08-2-2		
1-230-08-2-2		
1435/5		
2484-30, 2484-45, 2484-60		
3734-2, 3734-3, 3734-4, 3734-5, 3734-6, 3734-8		
3735-4-120, 3735-5-120		
3740-150, 3740-250		
4543-3		
4611-3		
481-400		
7865		
3625N-32		
1418-4, 1418-5, 1418-6, 1418-7.5		

Skumplastinlägg för 40" vagn, sats med sexkantigt T-handtag, bräckjärn och bladmått – 21 delar



FF1B09LM



35 x 445 x 880 mm



1 FF1B09LM

900T-025-100, 900T-030-100, 900T-040-150, 900T-050-150, 900T-060-200, 900T-080-200		
901T-010-100, 901T-015-150, 901T-020-150, 901T-025-150, 901T-027-150, 901T-030-200, 901T-040-200		
BE256-155, BE256-178, BE256-250		
BE66152		
BT10P325, BT10P330, BT10P338		
1544		

Skumplastinlägg för 40" vagn, bågfil, spårningstång och griptänger – 20 delar



FF1B10LM



45 x 445 x 880 mm



1 FF1B10LM

2633/S4		
2800-140, 2800-180		
2890-125, 2890-180		
2900-140, 2900-180		
2951-180		
2952-165		
2963-280		
2965-200		
2990-125, 2990-180		
BE-8986		
325		
2681		
CR B 02		

Skumplastinlägg för 40" vagn, sats med metallclips för 1/4", 3/8", 1/2" hylsor och 3/4" hylsor och tillbehör – 104 delar



FF1B11LM



50 x 445 x 880 mm



1 FF1B11LM

RAIL-264		
CLIPS-1/4		
CLIPS-3/8		
CLIPS-1/2		
SLX 17		

Verktygssats med hylsor och tillbehör i tum, för metallväskor i serierna 1483K & 1483KHD-79 delar



FF3A01



64 x 245 x 505 mm



1 FF3A01

A6700DZ-1/2, A6700DZ-1/4, A6700DZ-11/32, A6700DZ-3/8, A6700DZ-5/16, A6700DZ-7/16, A6700DZ-7/32, A6700DZ-9/32		
A6710DZ-3/8, A6710DZ-5/16, A6710DZ-7/16		
A6800DZ-1/4, A6800DZ-5/16, A6800DZ-7/32, A6800DZ-9/32		
A7400DM-10, A7400DM-13		
A7400DZ-1/2, A7400DZ-11/16, A7400DZ-3/4, A7400DZ-5/8, A7400DZ-9/16		
A7402DZ-1/2, A7402DZ-3/8, A7402DZ-7/16, A7402DZ-9/16		
1320RZ-1/4-5/16, 1320RZ-3/8-7/16		
59/S28-4		
6Z-1.1/16-1.1/4, 6Z-1.1/8, 6Z-7/8-15/16		
6950SL		
6956		
6958		
6960, 6961		
6966		
6972H		
7407H		
7750SL		
7752		
7760, 7761		
7764		
7765		
7766		
7800DZ-1, 7800DZ-13/16, 7800DZ-7/8		
8164-1/2		
8171		



Skumplastinlägg med skruvmejslar, skjutmått etc för metallväskor i 1483K- och 1483KHD-serien – 13 delar



FF3A02



39 x 210 x 445 mm



1 FF3A02

BE-3529		
BE-8020L		
BE-8155		
BE-8260		
BE-8601		
BE-8611, BE-8621		
1150-1/2H/P		
1177-SCRIBE		
2047-1.2-8		
2047PR-1-2		
5515T-52		
9715-14-250		

Skumplastinlägg med tänger, måttband, ficklampa etc för metallväskor i 1483K- och 1483KHD-serien – 12 delar



FF3A03



48 x 210 x 450 mm



1 FF3A03

MTB-3-16-M-E		
2101GC-160IP		
2421GC-180IP		
2855 D		
3658A-2, 3658A-3, 3658A-5		
8224CIP		
0454800500		

Skumplastinlägg med fasta nycklar, ledhandtag och skiftnyckel för metallväskor i 1483K- och 1483KHD-serien – 20 delar



FF3A04



45 x 210 x 445 mm



1 FF3A04

1300Z-1/2-9/16, 1300Z-1/4-5/16, 1300Z-3/8-7/16, 1300Z-5/8-3/4, 1300Z-7/8-15/16, 1300Z-25/32-13/16, 1300Z-19/32-11/16		
6Z-19/32-11/16, 6Z-25/32-13/16, 6Z-3/8-7/16, 6Z-5/8-3/4, 6Z-1/4-5/16, 6Z-1/2-9/16		
9070C		
1931Z-7/32, 1931Z-1/4		
8157-15		

Skumplastinlägg med insexnycklar, bitsskruvmejsel, bits, kniv, hylsor och tillbehör, för metallväskor i 1483K- och 1483KHD-serien – 98 delar



FF3A05



60 x 245 x 510 mm



1 FF3A05

A6700DZ-1/2, A6700DZ-1/4, A6700DZ-11/32, A6700DZ-3/16, A6700DZ-3/8, A6700DZ-5/16, A6700DZ-7/16, A6700DZ-7/32, A6700DZ-9/16, A6700DZ-9/32		
A6710DZ-1/4, A6710DZ-11/32, A6710DZ-3/8, A6710DZ-5/16, A6710DZ-7/16		
A6800DM-4		
A6800DZ-1/2, A6800DZ-1/4, A6800DZ-11/32, A6800DZ-3/8, A6800DZ-5/16, A6800DZ-7/16, A6800DZ-3/16, A6800DZ-7/32, A6800DZ-9/16, A6800DZ-9/32		

A7400DZ-1/2, A7400DZ-11/16, A7400DZ-13/16, A7400DZ-17/32, A7400DZ-19/32, A7400DZ-3/4, A7400DZ-5/8, A7400DZ-9/16

59/S28-4		
BE-9780		
KE18-01		
1544		
2058-BR		
59S/TS-1/4		
6950SL		
6956		
6960, 6962		
6966		
6972H		
7407H		
7752		
7750SL		
7760, 7761		
7764		
7765		
7766		
808050		
9071C		
8164-1/2		

Skumplastinlägg med skruvmejslar och skjutmått för metallväskor i 1483K- och 1483KHD-serien – 16 delar



FF3A06



40 x 205 x 450 mm



1 FF3A06

BE-8030		
BE-8150, BE-8155		
BE-8260		
BE-8350		
BE-8602		
BE-8610, BE-8620		
1177-SCRIBE		
2047-1-5.5		
2047PR-1-2		
5515T-52		
704Z-3/32		
1150-1/2H/P		

Skumplastinlägg med tänger, måttband etc för metallväskor i 1483K- och 1483KHD-serien – 11 delar



FF3A07



39 x 202 x 450 mm

1 FF3A07

MTB-3-16-E	
2101GC-160IP	
2427 GC-200IP	
2628 GC-160IP	
2632	
2650	
2855	
3734-3, 3734-5, 3734-8	
8224CIP	

Skumplastinlägg med fasta nycklar och spärringnycklar i tum-dimensioner, för metallväskor i 1483K- och 1483KHD-serien – 23 delar



FF3A08



43 x 205 x 450 mm

1 FF3A08

1320RZ-1/2-9/16, 1320RZ-5/16-11/32, 1320RZ-1/4-5/16, 1320RZ-3/8-7/16	
1952Z-1/2, 1952Z-1/4, 1952Z-11/16, 1952Z-11/32, 1952Z-13/16, 1952Z-3/4, 1952Z-3/8, 1952Z-5/16, 1952Z-5/8, 1952Z-7/16, 1952Z-7/8, 1952Z-9/16	
6Z-19/32-11/16, 6Z-1/2-9/16, 6Z-1/4-5/16, 6Z-13/16-7/8, 6Z-3/8-7/16, 6Z-5/16-11/32, 6Z-5/8-3/4	

Skumplastinlägg med hylsor och tillbehör för metallväskor i 1483K- och 1483KHD-serien – 95 delar



FF3A09



65 x 250 x 515 mm

1 FF3A09

A6800DM-7, A6800DM-6, A6800DM-5.5, A6800DM-11, A6800DM-10, A6800DM-9, A6800DM-8, A6800DM-13, A6800DM-12	
A7402DM-19, A7402DM-18, A7402DM-17, A7402DM-12, A7402DM-11, A7402DM-10, A7402DM-16, A7402DM-15, A7402DM-14, A7402DM-13	
1544	
2058-BR	
6700SM-8, 6700SM-7, 6700SM-6, 6700SM-5.5, 6700SM-12, 6700SM-11, 6700SM-10, 6700SM-9, 6700SM-13	
6709M-8, 6709M-6, 6709M-5, 6709M-4, 6709M-3	
6709PH-2, 6709PH-1, 6709PH-3	
6709TORX-T25, 6709TORX-T20, 6709TORX-T15, 6709TORX-T10, 6709TORX-T40, 6709TORX-T30, 6709TORX-T27, 6709TORX-T9, 6709TORX-T8	
6950SL	
6954	
6956	
6958	
6960, 6961, 6962, 6962L	
6966	
6972H	
7400SM-8, 7400SM-7, 7400SM-6, 7400SM-19, 7400SM-18, 7400SM-17, 7400SM-22, 7400SM-12, 7400SM-11, 7400SM-10, 7400SM-9, 7400SM-16, 7400SM-15, 7400SM-14, 7400SM-13	
7407H	
7409M-10, 7409M-8, 7409M-7, 7409M-6, 7409M-5, 7409M-4, 7409M-3	
7409TORX-T27, 7409TORX-T25, 7409TORX-T50, 7409TORX-T45, 7409TORX-T40, 7409TORX-T30	
7750SL	
7754	
7758	
7760, 7761	
7764	
7765	
7766	
8164-1/2	

Skumplastinlägg med skruvmejslar och bits för metallväskor i 1483K- och 1483KHD-serien – 53 delar



FF3A10



39 x 205 x 445 mm

1 FF3A10

BE-8020L, BE-8030	
BE-8155	
BE-8260	
BE-8350	
BE-8601, BE-8602	
BE-8610, BE-8620	
BE-9770	
2047-0.8-4	
2047PR-1-2	
808050P	
808050S	
59S/31-1	

Skumplastinlägg med tänger, mätverktyg etc för metallväskor i 1483K- och 1483KHD-serien – 12 delar



FF3A11



39 x 205 x 445 mm

1 FF3A11

1150-1/2H/P	
MTB-3-16	
1177-SCRIBE	
2101GC-160IP	
2427 GC-200IP	
2430 GC-200 IP	
2628 GC-160IP	
3734-3, 3734-5, 3734-8	
3735-4-120	
8224CIP	



Skumplastinlägg med fasta nycklar, skiftnyckel, ficklampa etc för metallväskor i 1483K- och 1483KHD-serien – 28 delar



FF3A12



45 x 205 x 450 mm

1 FF3A12

111M-6, 111M-21, 111M-19, 111M-18, 111M-22, 111M-13, 111M-12, 111M-11, 111M-10, 111M-17, 111M-16, 111M-15, 111M-14, 111M-9, 111M-8, 111M-7



2820EF2



5515T-52



6M-10-11, 6M-6-7, 6M-12-13, 6M-8-9, 6M-14-15, 6M-16-17, 6M-18-19, 6M-20-22



9070C



Skumplastinlägg med hylsor och tillbehör för metallväskor i 1483K- och 1483KHD-serien – 49 delar



FF3A13



68 x 245 x 525 mm

1 FF3A13

111M-27, 111M-32, 111M-24, 111M-30



6M-24-27, 6M-30-32



7800SM-19, 7800SM-18, 7800SM-17, 7800SM-16, 7800SM-22, 7800SM-21, 7800SM-11, 7800SM-10, 7800SM-15, 7800SM-14, 7800SM-13, 7800SM-12, 7800SM-27, 7800SM-32, 7800SM-30, 7800SM-24



7807H



7809M-10, 7809M-12, 7809M-14, 7809M-19, 7809M-17, 7809M-5, 7809M-8, 7809M-6, 7809M-7



7809TORX-T50, 7809TORX-T45, 7809TORX-T60, 7809TORX-T55, 7809TORX-T25, 7809TORX-T20, 7809TORX-T40, 7809TORX-T30, 7809TORX-T27



8150SL



8164-1/2



8154-11



8160-5, 8160-10



8171



8166



8172



Skumplastinlägg med hylsor och tillbehör i tum-dimensioner, för metallväskor i 1483K- och 1483KHD-serien – 77 delar



FF3A14



65 x 247 x 510 mm

1 FF3A14

A6700DZ-1/2, A6700DZ-1/4, A6700DZ-3/8, A6700DZ-5/16, A6700DZ-7/16, A6700DZ-7/32, A6700DZ-9/16, A6700DZ-9/32, A6700DZ-11/32



A6800DZ-1/4, A6800DZ-5/16, A6800DZ-7/32, A6800DZ-9/32



A7400DM-10, A7400DM-13



A7400DZ-1/2, A7400DZ-11/16, A7400DZ-13/16, A7400DZ-3/4, A7400DZ-5/8, A7400DZ-7/8, A7400DZ-9/16



A7402DZ-1/2, A7402DZ-3/8, A7402DZ-7/16, A7402DZ-9/16



111Z-1, 111Z-1.1/8



59/S28-4



6Z-1.1/16-1.1/4, 6Z-1-1.1/8



6Z/8C



6950SL



6958



6960, 6961



6966



6972H



7407H, 7408H



7750SL



7752



7760, 7761



7764



7765



7766



7800DZ-1, 7800DZ-15/16



8164-1/2



1952Z-15/16



8171



Skumplastinlägg med skruvmejslar för metallväskor i 1483K- och 1483KHD-serien – 14 delar



FF3A15



40 x 210 x 445 mm

1 FF3A15

BE-3529



BE-8020L



BE-8155



BE-8260



BE-8601, BE-8602



BE-8611, BE-8621



1177-SCRIBE



2047-1.2-8



2047PR-1-2



5515T-52



9715-14-250



Skumplastinlägg med tänger, måttband, ficklampa etc för metallväskor i 1483K- och 1483KHD-serien – 12 delar



FF3A16



42 x 210 x 445 mm

1 FF3A16

MTB-3-16-E



2101GC-160IP



2421GC-180IP



3658A-3, 3658A-5, 3658A-8



3735-5-120



3740-150



8224CIP



2855 D



0454800500

Skumplastinlägg med fasta nycklar, ledhandtag, insexnycklar, kombinationstång etc för metallvaskor i 1483K- och 1483KHD-serien – 30 delar



FF3A17

48 x 205 x 450 mm	1 FF3A17

BE-9780	
KE18-01	
1300Z-1/4-5/16, 1300Z-3/8-7/16	
1320RZ-1/4-5/16, 1320RZ-3/8-7/16	
1931Z-1/4, 1931Z-7/32	
1952Z-1/2, 1952Z-11/16, 1952Z-11/32, 1952Z-13/16, 1952Z-3/4, 1952Z-5/8, 1952Z-7/8, 1952Z-9/16	
2628 GC-180IP	
7758	

Allroundverktygssats – 109 delar



981001100

109	27 kg	1 981001100

1546	
2521GC-160	
2630GC-180IP, 2630GC-200IP	
6M-12-13, 6M-14-15, 6M-10-11, 6M-6-7, 6M-8-9, 6M-20-22, 6M-21-23, 6M-24-27, 6M-25-28	
8150RN-1/2	
8154-1/2, 2421GC-160, 8160-1/2, 8162-1/2, 8166-1/2	
9048-400	
9-469-00-0-0	
1998M/10T	
3733-4	

3734-4	
814-100	
815-2-25, 815-1-100, 815-2-125	
9710-8-150, 9710-6-5-125	
2800-180	
SC127	
1-100-08-2-2, 1-100-10-2-2	
1150-1/2H/P	
2101D-140IP	
2535F1	
3906-300-24-2P	
2951-250	
2M-6-7, 2M-8-9, 2M-10-11, 2M-12-13, 2M-14-15, 2M-16-17, 2M-18-19, 2M-20-22, 2M-21-23, 2M-24-27	
3645-150-C	
4544-10	
813-3-75, 813-4-100, 813-5-5-125	
1-230-08-1-2	
2430 GC-160 IP	
3735-4-120	
2900-180	
3625W-35	
479-16	
869102500	
1-170-08-2-2	
1-210-08-2-2	
8072 C, 8071 C	
225-PLUS	
2427 GC-200IP	
3640-150-C	
7800DM-18, 7800DM-17, 7800DM-16, 7800DM-11, 7800DM-10, 7800DM-15, 7800DM-14, 7800DM-13, 7800DM-12, 7800DM-19, 7800DM-23, 7800DM-22, 7800DM-21, 7800DM-20, 7800DM-24, 7800DM-26, 7800DM-28, 7800DM-30, 7800DM-32, 7800DM-27	
813VDE-3-100	
6224	

Verktygssats för fordonsreparation och panel – 357 delar



AUTO

976 x 510 x 820 mm	1 AUTO	

FF1ASET-AUTO

Verktygssats för fordonsreparation och panel – 62 delar



1495TP-AUTO-M1

900 x 25 x 500 mm	1 1495TP-AUTO-M1

1495TP09	
BP910	
BP909TH	
BE-9678	
BE-9675	
29M-30	
2997-250	
1995LM-9, 1995LM-8, 1995LM-6	
3750	
1177-SCRIBE	
K7801M-9, K7801M-10, K7801M-11, K7801M-12, K7801M-13, K7801M-14, K7801M-15, K7801M-16, K7801M-17, K7801M-18, K7801M-19, K7801M-21, K7801M-22, K7801M-23, K7801M-24, K7801M-30, K7801M-32	
K7806M-15, K7806M-21, K7806M-24, K7806M-27	
K8901M-32, K8901M-34, K8901M-36	
K8964D	
K8167S	
K8160D-3	
2800-150	
2900-150	
3734S/6	
BE-8258TB	
1495TP-ACHL40x 9, 1495TP-ACHL65x 9, 1495TP-ACHL20x 33	



Verktygspanel med verktyg för fordonreparation – 53 delar



1495TP-AUTO-M2



900 x 25 x 500 mm



1 1495TP-AUTO-M2

1495TP09	
BE301	
K7801TORX-E10, K7801TORX-E12, K7801TORX-E14, K7801TORX-E16, K7801TORX-E18, K7801TORX-E20	
K8160D-2	
BE301CM	
BWHEPSSH8	
BE51038, BE510310, BE510312	
BP822	
BP825	
1495TP-ACHL40x 25, 1495TP-ACHL65x 4, 1495TP-ACHL20x 29	
1495TP-AC4	

1495TP09	
BE1GP5-T	
6968	
BE1SP1F	
BE6OF108	
BE6307414F	
BE6OFW	
BE1FFWF	
BE63064514F1	
BE6810Z, BE6810	
BE6FCP	
52	
1546	
2421GC-160	
8166-1/2	
5515M	
BE1P	
7455-60	
BE1FLD2, BE1FLD1, BE1FLD3	
BE65F65120	
7764	
8164-1/2	
BE6302712F	
6962-W	
6954	
BE6701VAG	
BE62110	
BE1310P427	
7406ZZ-21, 7406ZZ-16	
BE1SP14L	
BE1GP5	
1495TP-AC3	
1495TP-ACHL20x 38, 1495TP-ACHL40, 1495TP-ACHL65	

1495TP09	
BS618	
4545-N1, 4545-N11	
4545-1, 4545-2	
MTB-3-16	
361-14	
8900SM-41	
BS52	
8169-1/2, 8165-1/2	
747-22, 747-21, 747-19, 747-17, 747-15, 747-14, 747-13, 747-12	
BS40VAG	
BS56	
BS100PSA1	
BS45BMW	
1495TP-ACHL40x 10, 1495TP-ACHL65x 5, 1495TP-ACHL20x 20	

Verktygspanel med verktyg för fordonreparation – 32 delar



1495TP-AUTO-M5



900 x 25 x 500 mm



1 1495TP-AUTO-M5

1495TP09	
319	
484-1000	
SB3654BM-20	
3625S-44	
B192.004.200	
BE-8258TB	
2484/S4	
B194.030.150, B194.025.125, B194.020.100, B194.010.075	
600.005.012	
BBS165	
K7801TORX-E10, K7801TORX-E12, K7801TORX-E14, K7801TORX-E16, K7801TORX-E18, K7801TORX-E20, K7801TORX-E24	

Verktygspanel med verktyg för fordonreparation – 34 delar



1495TP-AUTO-M3



900 x 25 x 500 mm



1 1495TP-AUTO-M3

Verktygspanel med verktyg för fordonreparation – 23 delar



1495TP-AUTO-M4



900 x 25 x 500 mm



1 1495TP-AUTO-M4

BBR203P920, BBR203P925, BBR203P930, BBR203P940, BBR203P945, BBR203P950, BBR203P955, BBR203P960	
1495TP-ACHL40x 13, 1495TP-ACHL20x 38	
8226	

Verktøyspanel med verktøy for
fordonsreparasjon – 42 delar



1495TP-AUTO-M6

900 x 25 x 500 mm	1	1495TP-AUTO-M6

1495TP09	
FM10	
782-U	
BBR405	
BBR400	
BBR210P3	
BBR6131	
BBR204	
BBR1501	
BBR501011, BBR50121314	
2900-215	
7823	
BBR100	
1154	
6M-16-17, 6M-14-15	
1949M-17-19, 1949M-12-13, 1949M-10-11, 1949M-8-9	
1495TP-ACHL40x 2, 1495TP-ACHL20x 29	
1495TP-AC3	

Verktøyssats for fordonsreparasjon,
skumplastinlegg for 2 lådor – 62 delar



FF1ASET-AUTO-M1

50 x 543 x 445 mm	1	FF1ASET-AUTO-M1

BP910	
BP909TH	
BE-9678	
BE-9675	
29M-30	
2997-250	
1995LM-9, 1995LM-8, 1995LM-6	
3750	
1177-SCRIBE	
K7801M-9, K7801M-10, K7801M-11, K7801M-12, K7801M-13, K7801M-14, K7801M-15, K7801M-16, K7801M-17, K7801M-18, K7801M-19, K7801M-21, K7801M-22, K7801M-23, K7801M-24, K7801M-30, K7801M-32	
K7806M-15, K7806M-21, K7806M-24, K7806M-27	
K8901M-32, K8901M-34, K8901M-36	
K8964D	
K8167S	
K8160D-3	
2800-150	
2900-150	
3734S/6	
BE-8258TB	

Verktøyssats for fordonsreparasjon og
SAC-kopplingsjustering, skumplastinlegg
for 2 lådor – 54 delar



FF1ASET-AUTO-M2

60 x 543 x 445 mm	1	FF1ASET-AUTO-M2

BE301	
K7801TORX-E10, K7801TORX-E12, K7801TORX-E14, K7801TORX-E16, K7801TORX-E18, K7801TORX-E20	
K8160D-2	
BE301CM	
BWHEPSSH8	
BE51038, BE510310, BE510312	
BP822	
BP825	

Verktøyssats for fordonsreparasjon,
skumplastinlegg for 2 lådor – 34 delar



FF1ASET-AUTO-M3

40 x 543 x 445 mm	1	FF1ASET-AUTO-M3

BE1GP5-T	
6968	
BE1SP1F	
BE6OF108	
BE6307414F	
BE6OFW	
BE1FFWF	
BE63064514F1	
BE6810Z, BE6810	
BE6FCP	
52	
1546	
5515M	
BE1P	
7455-60	
BE1FLD2, BE1FLD1, BE1FLD3	
BE65F65120	
7764	
8164-1/2	
BE6302712F	
6962-W	
6954	
BE6701VAG	
BE62110	
BE1310P427	
7406ZZ-21, 7406ZZ-16	
BE1SP14L	
BE1GP5	
2421GC-160IP	
8166	



Verktygssats för fordonreparation,
skumplastinlägg för 2 lådor – 23 delar



FF1ASET-AUTO-M4



60 x 543 x 445 mm

1 FF1ASET-AUTO-M4

BS618	
4545-N1, 4545-N11	
4545-1, 4545-2	
MTB-3-16	
361-14	
8900SM-41	
BS52	
747-22, 747-21, 747-19, 747-17, 747-15, 747-14, 747-13, 747-12	
BS40VAG	
BS56	
BS100PSA1	
BS45BMW	
8157-24	
8171	

Verktygssats för fordonreparation,
skumplastinlägg för 2 lådor – 32 delar



FF1ASET-AUTO-M5



45 x 543 x 445 mm

1 FF1ASET-AUTO-M5

319	
484-1000	
SB3654BM-20	

3625S-44	
B192.004.200	
BE-8258TB	
2484/S4	
6225D	
B194.030.150, B194.025.125, B194.020.100, B194.010.075	
600.005.012	
BBS165	
K7801TORX-E10, K7801TORX-E12, K7801TORX-E14, K7801TORX-E16, K7801TORX-E18, K7801TORX-E20, K7801TORX-E24	
BBR203P920, BBR203P925, BBR203P930, BBR203P940, BBR203P945, BBR203P950, BBR203P955, BBR203P960	

Verktygssats för fordonreparation,
skumplastinlägg för 2 lådor – 42 delar



FF1ASET-AUTO-M6



40 x 543 x 445 mm

1 FF1ASET-AUTO-M6

FM10	
782-U	
BBR405	
BBR400	
BBR210P3	
BBR6131	
BBR204	
BBR150I	
BBR501011, BBR50121314	
2900-215	
7823	
BBR100	
1154	
6M-16-17, 6M-14-15	
1949M-17-19, 1949M-12-13, 1949M-10- 11, 1949M-8-9	

Verktygssats i 5 skumplastinlägg – 196
delar



FF1ASET-AUTO1



50 x 543 x 445 mm

1 FF1ASET-AUTO1

FF1A19	
FF1A20	
FF1A21	
FF1A22	
FF1A23	

Verktygssats i 4 skumplastinlägg – 168
delar



FF1ASET-AUTO2



50 x 543 x 445 mm

1 FF1ASET-AUTO2

FF1A19	
FF1A24	
FF1A21	
FF1A25	

Verktygssats för fordonreparation,
skumplastinlägg för 8 lådor – 357 delar



FF1ASET-AUTO



40 x 543 x 445 mm



1 FF1ASET-AUTO

FF1A218LM	
FF1A219LM	
FF1A220LM	
FF1A221LM	
FF1A222LM	
FF1A223LM	
FF1A224LM	
FF1A225LM	

Verktygssats i 3 skumplastinlägg – 140 delar



FF1ASET-AUTO3



50 x 543 x 445 mm



1 FF1ASET-AUTO3

FF1A28	
FF1A26	
FF1A27	

Verktygssats i 4 skumplastinlägg – 177 delar



FF1ASET-AUTO6



50 x 543 x 445 mm



1 FF1ASET-AUTO6

FF1A19	
FF1A72	
FF1A70	
FF1A71	

Formsprutad låda med justerbar
momentnyckel och krafthylsor–11 delar



4750BMC10FF1



84 x 341 x 447 mm



1 4750BMC10FF1

4750BMC10	
BWSHK21	
BWSMB15	
BWSMB17	
BWSS12P5	
BWTVCTT355	
74W9-200	
9R-1/2	

Robust sats med flygplansverktyg i hård
väska–240 delar



4750RCHDW01FF1



250 x 345 x 545 mm



1 4750RCHDW01FF1

4750RCHDW01	
FF2B01	
FF2B02	
FF2B03	
FF2B04	
FF2B05	
FF2B06	

Robust sats med verktyg för
flygplansunderhåll, i hård väska–159 delar



4750RCHDW01FF2



250 x 345 x 545 mm



1 4750RCHDW01FF2

4750RCHDW01	
FF2B07	
FF2B08	
FF2B09	
FF2B10	
FF2B11	



Sats med flygplansverktyg-159 delar/hård väska



4750RCHD01FF1

215 x 410 x 475 mm 1 4750RCHD01FF1

4750RCHD01	
FF2A07	
FF2A08	
FF2A10	
FF2A09	

Verktyglåda av metall med verktyg för flygindustrin-129 delar



1483KHD3RB-FF1

335 x 260 x 565 mm 1 1483KHD3RB-FF1

1483KHD3RB	
FF3A01	
FF3A02	
FF3A03	
FF3A04	

Verktyglåda i metall för flygindustri - 152 delar



1483KHD3RB-FF2

335 x 260 x 565 mm 1 1483KHD3RB-FF2

1483KHD3RB	
FF3A05	
FF3A06	
FF3A07	
FF3A08	
2509	
2535F2	
3625N-32	
481-400	
7762	

Verktyglåda i metall för flygindustri - 137 delar



1483KHD3RB-FF5

335 x 260 x 565 mm 1 1483KHD3RB-FF5

1483KHD3RB	
FF3A14	
FF3A15	
FF3A16	
FF3A17	

Verktyglåda i metall för flygindustri - 124 delar



1483KHD3RB-FF7

335 x 260 x 565 mm 1 1483KHD3RB-FF7

1483KHD3RB	
481-400	
2535F1	
7762	
6950SL	
6960, 6962	
6956	
7752	
6966	
6972H	
A6700DZ-3/16, A6700DZ-7/32, A6700DZ-1/4, A6700DZ-9/32, A6700DZ-5/16, A6700DZ-11/32, A6700DZ-3/8, A6700DZ-7/16, A6700DZ-1/2, A6700DZ-9/16	
A6710DZ-1/4, A6710DZ-5/16, A6710DZ-11/32, A6710DZ-3/8, A6710DZ-7/16	
A6800DZ-3/16, A6800DZ-7/32, A6800DZ-1/4, A6800DZ-9/32, A6800DZ-5/16, A6800DZ-11/32, A6800DZ-3/8, A6800DZ-7/16, A6800DZ-1/2, A6800DZ-9/16	
A6800DM-4	
BE-9780	
59/S28-4	
59S/TS-1/4	
9070 P	
808050	
2058-BR	
KE18-01	
1150-1/2H/P	
2047-1-5.5	
2047PR-1-2	
BE-8030	
BE-8150	
BE-8260	
BE-8350	

BE-8602		
BE-8610, BE-8620		
5515T-52		
1177-SCRIBE		
SR300-E		
704Z-3/32		
MTB-3-16-M-E		
2101GC-160IP		
2427 GC-200IP		
2855		
8224CIP		
2628 GC-160IP		
2632		
3734-3, 3734-5, 3734-8		
1300Z-1/4-5/16		
1320RZ-1/4-5/16, 1320RZ-3/8-7/16		
1952Z-15/16, 1952Z-1, 1952Z-1/4, 1952Z-5/16, 1952Z-11/32, 1952Z-3/8, 1952Z-7/16, 1952Z-1/2, 1952Z-9/16, 1952Z-5/8, 1952Z-11/16, 1952Z-3/4, 1952Z-13/16, 1952Z-7/8		
6Z-19/32-11/16		
3625N-32		

Robust hård väska med verktygssats för underhåll av olje- och gaskranar-29 st



4750RCHDW01FF4

250 x 345 x 545 mm 1 4750RCHDW01FF4

TAH8075		
TAH479-32		
TAHBE-9777B		
TAHBE-9787		
TAH2820EF2		
TAHBFRL11		
TAH466-250		
TAHPINREASER		
TAH380-10		
TAH2101G-160		
TAH2628G-180		
TAH2855		

TAH8224		
TAHSCB140G		
TAHBE-8258		
TAHBE-8241, TAHBE-8252		
TAHBE-8620L, TAHBE-8620		
4750RCHDW01		
4750-HDLB-TAH		
3875-LY9		
3875-LY5		
3875-RL2		
3875-MHP4		
3875-MHP6		
3875-HB60		
3875-LY60		
3875-LY70		

Robust hård väska med verktygssats anpassad för utbildning inom olja och gas-41 delar



4750RCHDW01FF9

250 x 345 x 545 mm 1 4750RCHDW01FF9

TAH8073		
TAH84-PODGER		
TAH3640-250-C		
TAH1-143-12-1-2		
TAH479-32		
TAH325		
TAHBE-9777B		
TAH2820EF2		
TAHBFRL11		
TAHPINREASER		
TAH380-14		
TAH2101G-140		
TAH2628G-180		
TAH2855		
TAH2958-250		
TAH2484-30		
TAH3734BM-8		

TAHSCB140G		
TAHBE-8257		
TAHBE-8602		
TAH16B-19		
TAH16B-11/16		
TAH16-H8		
TAH8150-1/2		
TAH8158B-1		
TAH7455-300-1		
TAH1949M-14-17		
4750RCHDW01		
4750-HDLB-TAH		
3875-LY9		
3875-LY5		
3875-RL2		
3875-MHP4		
3875-MHP6		
MTS-5-25		
4750-MTHO-TAH		
3875-HB60		
TAH2487		
TAH466-250		
3875-LY60		
3875-LY70		

Robust hård väska med verktygssats för drift och underhåll-195 delar



4750RCHDW02FF1

275 x 460 x 600 mm 1 4750RCHDW02FF1

4750RCHDW02		
6700SM-12, 6700SM-13, 6700SM-10, 6700SM-11, 6700SM-8, 6700SM-9, 6700SM-6, 6700SM-7, 6700SM-5.5		
A6800DM-13, A6800DM-11, A6800DM-12, A6800DM-9, A6800DM-10, A6800DM-7, A6800DM-8, A6800DM-5.5, A6800DM-6		
6709M-3, 6709M-4, 6709M-8, 6709M-5, 6709M-6		
6709PH-1, 6709PH-2, 6709PH-3		



6709TORX-T8, 6709TORX-T30, 6709TORX-T40, 6709TORX-T25, 6709TORX-T27, 6709TORX-T15, 6709TORX-T20, 6709TORX-T9, 6709TORX-T10		
6950SL		
6954		
6956		
6958		
6960, 6962, 6962L		
6966		
6972H		
7764		
7800SM-13, 7800SM-14, 7800SM-11, 7800SM-12, 7800SM-9, 7800SM-10, 7800SM-8, 7800SM-32, 7800SM-30, 7800SM-27, 7800SM-28, 7800SM-25, 7800SM-26, 7800SM-23, 7800SM-24, 7800SM-21, 7800SM-22, 7800SM-19, 7800SM-17, 7800SM-18, 7800SM-15, 7800SM-16		
7805SM-22, 7805SM-23, 7805SM-21, 7805SM-18, 7805SM-19, 7805SM-16, 7805SM-17, 7805SM-14, 7805SM-15, 7805SM-12, 7805SM-13, 7805SM-10, 7805SM-32, 7805SM-30, 7805SM-24, 7805SM-27, 7805SM-24, 7805SM-29, 7805SM-28, 7805SM-25, 7805SM-20		
7809TORX-T30, 7809TORX-T40, 7809TORX-T25, 7809TORX-T27, 7809TORX-T50, 7809TORX-T45		
8150RN-1/2		
111M-23, 111M-24, 111M-21, 111M-22, 111M-19, 111M-17, 111M-18, 111M-15, 111M-16, 111M-13, 111M-14, 111M-11, 111M-12, 111M-9, 111M-10, 111M-7, 111M-8, 111M-6, 111M-32, 111M-29, 111M-30, 111M-27, 111M-28, 111M-26, 111M-25		
1RM-18, 1RM-19, 1RM-16, 1RM-17, 1RM-14, 1RM-15, 1RM-12, 1RM-13, 1RM-10, 1RM-11, 1RM-8, 1RM-9, 1RM-6, 1RM-7		
9070C		
BE-9770		
BE-8571		
2058-BR		
2509		
1544		
2101G-160IP		
2427 G-200 IP		
2430 G-200 IP		
2628 G-160IP		
8224 IP		
1150-1/2H/P		
5515T-52		
2820EF2		
481-300		
3625W-35		
3734-3, 3734-5, 3734-8		
3735-4-120		
1177-SCRIBE		
2535F1		
MTB-3-16		
8160-3, 8160-5, 8160-10		
8166		
8154-11		
8157-15		

Stängd verktygsväska med verktygssats för drift och underhåll – 61 delar



4750FB2-19TS001

500 mm	250 mm	1	4750FB2-19TS001

4750FB2-19A		
BE-8010S, BE-8040S, BE-8050S, BE-8220S		
BE-8610S, BE-8620S, BE-8630S		
BE-8800S, BE-8820S, BE-8830S		
706-4		
PC-12-VEN		
1-210-08-2-2		
2101G-180		
2233 D-200		
2628 G-180		
268		
3830-20-VIP, 3830-25-VIP		
3834-ARBR-730		
4130		
424P-16, 424P-20, 424P-25		
428-16		
484-1250		
806-1-1		
8231		
9031		
SL25		

Textilväska med hjul och verktygssats för drift och underhåll – 72 delar



4750FB2W-TS001

390 x 400 x 685 mm	1	4750FB2W-TS001

4750FB2W-24A		
SL25		
BE-8030, BE-8242		
S240		
BE-8155		
BE-8600, BE-8610, BE-8620		
BE-8800, BE-8810, BE-8820		
BE-8040S		
2628 G-180		
2101G-180		
7224		
1520 G		
MTB-5-25		
MA421		
268		
325		
479-16		
KERU-01		
5515T		
9071		

MRO-verktygssats för drift och underhåll i 7 skumplastinlägg – 256 delar



FF1ASET-MRO2

530 x 600 x 800 mm	1	FF1ASET-MRO2

FF1A130		
FF1A131		
FF1A132		
FF1A133		
FF1A134		
FF1A135		
FF1A136		

MRO-verktygssats för drift och underhåll i 5 skumplastinlägg – 188 delar



FF1ASET-MRO3

 530 x 600 x 800 mm 1 FF1ASET-MRO3

FF1A138		
FF1A137		
FF1A134		
FF1A139		
FF1A141		

MRO-verktygssats för drift och underhåll i 4 skumplastinlägg – 147 delar



FF1ASET-MRO4

 530 x 600 x 800 mm 1 FF1ASET-MRO4

FF1A143		
FF1A142		
FF1A145		
FF1A134		

MRO-verktygssats för drift och underhåll, i 3 skumplastinlägg – 84 delar



FF1ASET-MRO5

 530 x 600 x 800 mm 1 FF1ASET-MRO5

FF1A147		
FF1A146		
FF1A134		

Robust hård väska med verktygssats anpassad för arbete med vindkraftverk – 114 st



4750RCHDW02FF4

 480 x 290 x 630 mm 1 4750RCHDW02FF4

TAH9070, TAH9072		
TAH3625W-35		
TAH481-300		

TAHBE-9777B		
TAH2820EF2		
TAH1150-1/2H/P		
TAH1177-SCRIBE		
TAH1544		
TAH2509		
TAH2535F2		
MTS-5-25		
TAHPINRELEASER		
TAH2427G-200		
TAH2430G-200		
TAH2628G-160		
TAH8224		
TAH2484-30		
TAH3734BM-3, TAH3734BM-8, TAH3734BM-5		
TAH3755BM-4		
TAHSCB140G		
TAHBE-8030, TAHBE-8020L		
TAHBE-8040S, TAHBE-8050S, TAHBE-8220S		
TAHBE-8155		
TAHBE-8260		
TAHBE-8620S, TAHBE-8610S		
TAHBE-8620, TAHBE-8610		
TAHBE-8630		
TAHBE-8810, TAHBE-8820		
TAHBE-8830		
TAH08-5.5, TAH08-9, TAH08-7, TAH08-8, TAH08-13, TAH08-6, TAH08-11, TAH08-10, TAH08-12		
TAH6961, TAH6962, TAH6960, TAH6962L		
TAH6956-1		
TAH6950		
TAH6966		
TAH6958B-1		
TAH16B-27, TAH16B-30, TAH16B-24, TAH16B-22, TAH16B-32, TAH16B-19, TAH16B-21, TAH16B-17, TAH16B-18, TAH16B-11, TAH16B-15, TAH16B-16, TAH16B-13, TAH16B-10, TAH16B-14, TAH16B-12		
TAH16-H8, TAH16-H6, TAH16-H7, TAH16-H5, TAH16-H17, TAH16-H19, TAH16-H12, TAH16-H14, TAH16-H10		
TAH16-T40, TAH16-T45, TAH16-T50, TAH16-T55, TAH16-T60		
TAH8166		
TAH8150-1/2		
TAH8160, TAH8162		
TAH8158B-1		
TAH111M-32, TAH111M-27, TAH111M-24, TAH111M-21, TAH111M-22, TAH111M-19, TAH111M-9, TAH111M-7, TAH111M-8, TAH111M-18, TAH111M-6, TAH111M-16, TAH111M-17, TAH111M-14, TAH111M-15, TAH111M-12, TAH111M-13, TAH111M-10, TAH111M-11, TAH111M-30		
TAH2101G-160		
TAH2047PR-1-2		
TAH2047-0.8-4		
4750RCHDW02		



Robust hård väska med verktygssats
anpassad för arbete med vindkraftverk-36
delar



4750RCHDW02FF15



480 x 290 x 630 mm

1 4750RCHDW02FF15

TAH1-100-06-2-4		
TAH1-210-06-2-2		
TAH1-230-06-2-2		
TAH3625PU-50		
TAH489-1100		
TAHBE64520		
TAHPINRELEASER		
TAHSCB140G		
TAH24B-50, TAH24B-46, TAH24B-41, TAH24B-38, TAH24B-36, TAH24B-32, TAH24B-30, TAH24B-27		
TAH8950N/A		
TAH8961		
TAH8953		
TAH7452-2		
TAH7455-300-1		
TAH7435-100		
TAH111M-50, TAH111M-46, TAH111M-41, TAH111M-36, TAH111M-34		
TAH7444SG-M-46, TAH7444SG-M-41, TAH7444SG-M-36, TAH7444SG-M-55, TAH7444SG-M-50		
4750RCHDW02		

Etui med blytläs med verktygssats för
elektriker-17 st



9852



360 x 40 x 240 mm

1 9852

TM3m

7890



8160



8070



TL AA-SA-SL



2421 G-160



2101G-160



2628 G-180



BE-8210, BE-8040



BE-8150, BE-8155



BE-8600, BE-8610, BE-8620



8045LVDE



K-AP-1



Etui med blytläs, med verktygssats för
elektriker-7 st



9841



275 x 48 x 330 mm

1 9841

7190



7890



TL AA-SA-SL



BE-8020, BE-8040



BE-8610



8070



Robust hård väska med verktygssats för
vindkraftverk-167 delar



4750RCHDW02FF2



480 x 290 x 630 mm

1 4750RCHDW02FF2

4750RCHDW02

6700SM-12, 6700SM-13, 6700SM-10,
6700SM-11, 6700SM-8, 6700SM-9,
6700SM-6, 6700SM-7, 6700SM-5.5

6954

6956

6958

6960, 6961, 6962, 6962L

6966

6972H

6950SL

7800SM-13, 7800SM-14, 7800SM-11,
7800SM-12, 7800SM-10, 7800SM-32,
7800SM-30, 7800SM-27, 7800SM-24,
7800SM-21, 7800SM-19, 7800SM-17,
7800SM-18, 7800SM-15, 7800SM-16,
7800SM-22

7809M-7, 7809M-6, 7809M-17, 7809M-
19, 7809M-5, 7809M-14, 7809M-12,
7809M-10, 7809M-8

7809TORX-T60, 7809TORX-T40,
7809TORX-T55, 7809TORX-T50,
7809TORX-T45

59S/31-1

8150SL

111M-24, 111M-21, 111M-19, 111M-17,
111M-18, 111M-15, 111M-16, 111M-13,
111M-14, 111M-11, 111M-12, 111M-9,
111M-10, 111M-7, 111M-8, 111M-6,
111M-32, 111M-29, 111M-30, 111M-27

BE-9770

1177-SCRIBE

6M-6-7, 6M-8-9, 6M-10-11, 6M-12-13,
6M-14-15, 6M-16-17, 6M-18-19,
6M-20-22, 6M-24-27, 6M-30-32

MTB-3-16-E

9070, 9072

2535L

BE-8020L, BE-8030

BE-8155

BE-8260

BE-8610, BE-8620

BE-8630

BE-8810, BE-8820

BE-8830		
1544		
2047-0.8-4		
TAH2047PR-1-2		
2058-BR		
2509		
808050P		
808050S		
BE-8220S, BE-8040S, BE-8050S		
BE-8610S, BE-8620S		
2535F2		
1150-1/2H/P		
2101G-160IP		
2427 G-200 IP		
2430 G-200 IP		
2628 G-160IP		
2820EF2		
5515T-52		
8224 IP		
3625W-35		
3734-3, 3734-5, 3734-8		
3735-4-120		
481-300		
3680		
3875-RL1		
3875-WL1		
4750-3PB-2		
3750		
8157-15		
8154-11		
8160-5, 8160-10		
8171		
8166		

VERKTYGSVÄSKA I PLAST

Robust hård väska, storlek 31 liter 



240 x 350 x 545 mm	1	4750RCHDW01
240 x 350 x 545 mm	1	4750RCHDW01RED

60x20 mm hjul even when very loaded

Robust hård väska med hjul, storlek 53 liter 



290 x 480 x 630 mm	1	4750RCHDW02
290 x 480 x 630 mm	1	4750RCHDW02RED

60x37 mm hjul

29 L extra kraftig hård väska 



215 x 415 x 465 mm	1	4750RCHD01

29 L tålig hård väska med verktygspaneler 



215 x 415 x 465 mm	1	4750RCHD011

18,5 L Extra kraftig hård väska 



205 x 345 x 400 mm	1	4750RCHD00

Extra kraftiga väskor med hjul, storlek 153,9 liter 



460 x 560 x 860 mm	1	4750RCHDW10

Hård väska med hjul och teleskophandtag samt 4 utdragslådor, storlek 150 liter 



453 x 340 x 575 mm	1	4750RCWD4
453 x 340 x 575 mm	1	4750RCWD4-OR



Hård väska med hjul och teleskophandtag, storlek 42 liter



4750RCW01



257 x 406 x 485 mm
257 x 406 x 485 mm



1 4750RCW01
1 4750RCW011

4750RCW01: Med transparenta fickor 4750RCW011: Med elastiska band

35 L Hård väska



4750RC02



221 x 406 x 485 mm
221 x 406 x 485 mm



1 4750RC02
1 4750RC021

4750RC02: Paneler med transparenta fickor 4750RC021: Paneler med elastiska band

23-35 L Hård väska



4750RC01



165 x 399 x 450 mm



1 4750RC01

Sats med vridbara hjul-4 st



4750RCWD-AC1



100 x 50 x 200 mm



1 4750RCWD-AC1

Verktygspanel med fickor, för placering under locket



4750RCWD-AC2



30 x 277 x 507 mm



1 4750RCWD-AC2

Verktygspanel med fasta gummiband, för placering under locket



4750RCWD-AC3



5 x 277 x 507 mm



1 4750RCWD-AC3

Fast verktygspanel för placering under locket med justerbara gummiband



4750RCWD-AC4



4 x 286 x 490 mm



1 4750RCWD-AC4

Borttagbart vadderat lock för 4750RCHD01



4750RCHD01AC1



35 x 305 x 425 mm



1 4750RCHD01AC1

Borttagbar vadderad innerväska för 4750RCHD01 robust hård verktygsväska



4750RCHD01AC2



135 x 360 x 450 mm



1 4750RCHD01AC2

Borttagbart lock för 4750RCHDW01 robust
hård verktygsväska



4750RCHDW01AC1



50 x 204 x 500 mm

1 4750RCHDW01AC1

Invändiga väskor för 4750RCHDW01
robust hård verktygsväska



4750RCHDW01AC2



120 x 280 x 525 mm

1 4750RCHDW01AC2

TSA-lås för 4750RCHD-väskor



4750RCHD-AC1



20 x 40 x 70 mm

1 4750RCHD-AC1

Skumplastinlägg med hylsor och tillbehör
för 4750RCHD01 extra kraftig hård väska
- 64 delar



FF2A07



45 x 330 x 430 mm

1 FF2A07

A6700DZ-1/2, A6700DZ-1/4,
A6700DZ-11/32, A6700DZ-3/16,
A6700DZ-3/8, A6700DZ-5/16,
A6700DZ-7/16, A6700DZ-7/32,
A6700DZ-9/16, A6700DZ-9/32



A6710DZ-3/8, A6710DZ-5/16,
A6710DZ-7/16, A6710DZ-1/4



A6800DZ-1/2, A6800DZ-1/4,
A6800DZ-11/32, A6800DZ-3/16,
A6800DZ-3/8, A6800DZ-5/16,
A6800DZ-7/16, A6800DZ-7/32,
A6800DZ-9/16, A6800DZ-9/32

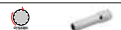

A7400DZ-1/2, A7400DZ-11/16,
A7400DZ-13/16, A7400DZ-19/32,
A7400DZ-3/4, A7400DZ-3/8,
A7400DZ-5/8, A7400DZ-7/16,
A7400DZ-7/8, A7400DZ-9/16



A7402DZ-1/2, A7402DZ-11/16,
A7402DZ-13/16, A7402DZ-19/32,
A7402DZ-3/4, A7402DZ-3/8,
A7402DZ-5/8, A7402DZ-7/16,
A7402DZ-7/8, A7402DZ-9/16



2058-BR



6950SL



6954



6956



6960, 6962, 6962L



6966



6972H



7407H, 7408H



7750SL

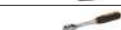

7752



7760, 7761, 7762



7764



7765



7766

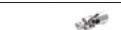

8164-1/2



Skumplastinlägg med fasta nycklar,
spärnycklar, skiftnycklar, bågfil och filar
för 4750RCHD01 extra kraftig hård väska
- 24 delar



FF2A08



45 x 335 x 435 mm

1 FF2A08

1-100-04-2-2



1-230-04-2-2

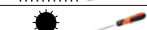

111Z-1, 111Z-1/2, 111Z-1/4, 111Z-11/16,
111Z-3/4, 111Z-3/8, 111Z-5/16, 111Z-5/8,
111Z-7/16, 111Z-9/16, 111Z-7/8

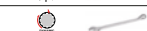

1177-SCRIBE



1320RZ-1/2-9/16, 1320RZ-1/4-5/16,
1320RZ-3/8-7/16, 1320RZ-5/16-11/32



1931Z-1/4, 1931Z-3/16, 1931Z-7/32



1950MZ-3/8



208



9031 C



Skumplastinlägg med skruvmejslar och
insexnycklar för 4750RCHD01 extra kraftig
hård väska - 56 delar



FF2A09



45 x 335 x 440 mm

1 FF2A09

BE-8040, BE-8210

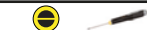

BE-8260



BE-8600, BE-8610, BE-8620



BE-9780

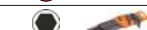

MTB-3-16-E



2047-1-5.5



2047PPR-1-2



59/S28-4

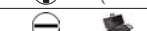

2509



2535F2



5515T-52



808050



BE-8150



Skumplastinlägg med hylsor och tillbehör för 4750RCHDW01 extra kraftig hård väska – 61 delar



FF2B01



40 x 270 x 505 mm



1 FF2B01

A6700DZ-1/2, A6700DZ-1/4, A6700DZ-11/32, A6700DZ-3/16, A6700DZ-3/8, A6700DZ-5/16, A6700DZ-7/16, A6700DZ-7/32, A6700DZ-9/16, A6700DZ-9/32



A6800DZ-1/2, A6800DZ-1/4, A6800DZ-11/32, A6800DZ-3/16, A6800DZ-3/8, A6800DZ-5/16, A6800DZ-7/16, A6800DZ-7/32, A6800DZ-9/16, A6800DZ-9/32



A7400DZ-1/2, A7400DZ-1/4, A7400DZ-11/16, A7400DZ-17/32, A7400DZ-19/32, A7400DZ-3/4, A7400DZ-3/8, A7400DZ-5/16, A7400DZ-5/8, A7400DZ-7/16, A7400DZ-9/16



A7402DZ-1/2, A7402DZ-1/4, A7402DZ-11/16, A7402DZ-19/32, A7402DZ-3/4, A7402DZ-3/8, A7402DZ-5/16, A7402DZ-5/8, A7402DZ-7/16, A7402DZ-9/16



6950SL



6954



6956



6958



6960, 6961, 6962L



6966



6972H



7407H



7750SL



7752



7760, 7761, 7762



7764



7765



7766



8164-1/2



Skumplastinlägg med fasta nycklar, insexnycklar, standard och långa hylsor för 4750RCHDW01 extra kraftig hård väska – 69 delar



FF2B02



39 x 270 x 505 mm



1 FF2B02

A6700DM-5.5, A6700DM-6, A6700DM-11, A6700DM-12, A6700DM-13, A6700DM-14, A6700DM-7, A6700DM-8, A6700DM-9, A6700DM-10



A6800DM-6, A6800DM-7, A6800DM-8, A6800DM-9, A6800DM-4, A6800DM-5, A6800DM-5.5, A6800DM-14, A6800DM-10, A6800DM-11, A6800DM-12, A6800DM-13



A7400DM-10, A7400DM-14, A7400DM-15, A7400DM-16, A7400DM-11, A7400DM-12, A7400DM-17, A7400DM-18, A7400DM-19, A7400DM-13



A7402DM-19, A7402DM-15, A7402DM-16, A7402DM-17, A7402DM-18, A7402DM-11, A7402DM-12, A7402DM-13, A7402DM-14, A7402DM-10



BE-9770



111M-24, 111M-6, 111M-7, 111M-12, 111M-13, 111M-14, 111M-15, 111M-8, 111M-9, 111M-10, 111M-11, 111M-22, 111M-16, 111M-17, 111M-18, 111M-19



4020L-M-5, 4020L-M-5.5



Skumplastinlägg med fasta nycklar, spärnycklar, insexnycklar, ledhylsor för 4750RCHDW01 extra kraftig hård väska



FF2B03



35 x 270 x 505 mm



1 FF2B03

A6710DM-7



A6710DZ-1/2, A6710DZ-1/4, A6710DZ-11/32, A6710DZ-3/16, A6710DZ-3/8, A6710DZ-5/16, A6710DZ-7/16, A6710DZ-7/32, A6710DZ-9/16, A6710DZ-9/32



BE-9780



111Z-1, 111Z-1/2, 111Z-1/4, 111Z-11/16, 111Z-3/4, 111Z-3/8, 111Z-5/16, 111Z-5/8, 111Z-7/16, 111Z-7/8, 111Z-9/16, 111Z-13/16

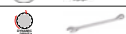

1320RZ-1/2-9/16, 1320RZ-1/4-5/16, 1320RZ-3/8-7/16, 1320RZ-5/16-11/32



1931Z-1/4, 1931Z-3/16, 1931Z-7/32



1950MZ-3/8



2058-BR



Skumplastinlägg med skruvmejslar, bladmått, skiftnyckel etc för 4750RCHDW01 extra kraftig hård väska – 45 delar



FF2B04



42 x 270 x 505 mm



1 FF2B04

BE-8020L, BE-8040



BE-8080-10



BE-8150, BE-8255



BE-8610, BE-8620

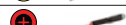

1544



2509



59/S28-4

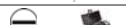

2535F2



5516



700-1.5-50, 700-1-50



701-0-50, 701-00-50

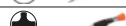

808050

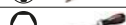

9070C

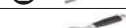

Skumplastinlägg med tänger, mätverktyg etc för 4750RCHDW01 extra kraftig hård väska – 15 delar



FF2B05



35 x 270 x 510 mm

1 FF2B05

1150-1/2H/P	
MTB-3-16-M-E	
2101GC-125IP, 2101GC-160IP	
2427 GC-200IP	
2628 GC-160IP	
2650	
2820EF2	
2855	
4130	
4830	
5515T-52	
8224CIP	

Skumplastinlägg med hammare och dornar etc för 4750RCHDW01 extra kraftig hård väska – 6 delar



FF2B06



35 x 122 x 355 mm

1 FF2B06

3625N-32	
3734-5, 3734-8, 3734-3	
3735-5-120	
481-300	

Skumplastinlägg med hylsor och tillbehör för 4750RCHDW01 extra kraftig hård väska



FF2B07



35 x 270 x 505 mm

1 FF2B07

A6700DZ-1/2, A6700DZ-1/4, A6700DZ-11/32, A6700DZ-3/16, A6700DZ-3/8, A6700DZ-5/16, A6700DZ-7/16, A6700DZ-7/32, A6700DZ-9/16, A6700DZ-9/32	
A6710DZ-3/8, A6710DZ-5/16, A6710DZ-7/16	
A6800DZ-1/2, A6800DZ-1/4, A6800DZ-11/32, A6800DZ-3/16, A6800DZ-3/8, A6800DZ-5/16, A6800DZ-7/16, A6800DZ-7/32, A6800DZ-9/16, A6800DZ-9/32	
A7400DZ-1/2, A7400DZ-11/16, A7400DZ-13/16, A7400DZ-19/32, A7400DZ-3/4, A7400DZ-3/8, A7400DZ-5/8, A7400DZ-7/16, A7400DZ-7/8, A7400DZ-9/16	
A7402DZ-1/2, A7402DZ-11/16, A7402DZ-13/16, A7402DZ-19/32, A7402DZ-3/4, A7402DZ-3/8, A7402DZ-5/8, A7402DZ-7/16, A7402DZ-7/8, A7402DZ-9/16	
6950SL	
6954	
6956	
6960, 6962, 6962L	
6966	
6972H	
7407H, 7408H	
7750SL	
7752	
7760, 7761, 7762	
7764	
7765	
7766	
8164-1/2	

Skumplastinlägg med fasta nycklar, skiifnycklar, filar, bågfil etc för 4750RCHDW01 extra kraftig hård väska – 25 delar



FF2B08



44 x 270 x 505 mm

1 FF2B08

1-100-04-2-2	
1-230-04-2-2	
111Z-1, 111Z-1/2, 111Z-1/4, 111Z-11/16, 111Z-3/4, 111Z-3/8, 111Z-5/16, 111Z-5/8, 111Z-7/16, 111Z-7/8, 111Z-9/16	
1177-SCRIBE	
1320RZ-1/2-9/16, 1320RZ-1/4-5/16, 1320RZ-3/8-7/16, 1320RZ-5/16-11/32	
1931Z-1/4, 1931Z-3/16, 1931Z-7/32	
1950MZ-3/8	
2058-BR	
208	
9031 C	

Skumplastinlägg med skruvmejslar för 4750RCHDW01 extra kraftig hård väska – 56 delar



FF2B09



47 x 270 x 505 mm

1 FF2B09

BE-8040, BE-8210	
BE-8150	
BE-8260	
BE-8600, BE-8610, BE-8620	
BE-9780	
MTB-3-16-E	
2047-1-5.5	
2047PR-1-2	
2509	
2535F2	
5515T-52	
59/S28-4	
808050	



Skumplastinlägg med tänger för flygindustrin, passar i 4750RCHDW01 extra kraftig hård väska – 9 delar



FF2B10



37 x 270 x 505 mm

1 FF2B10

2101GC-160IP	
2427 GC-200IP	
2430 GC-200 IP	
2628 GC-160IP	
2650	
2744	
2855	
2979 D-180	
8224CIP	

Skumplastinlägg med hammare, donrar etc för 4750RCHDW01 extra kraftig hård väska – 7 delar



FF2B11



39 x 122 x 355 mm

1 FF2B11

2632	
3625N-32	
3734-2, 3734-3, 3734-4, 3734-5	
481-300	

Skumplastinlägg med hylsor och tillbehör för 4750RCHDW01 extra kraftig hård väska – 92 delar



FF2B12



44 x 270 x 505 mm

1 FF2B12

A6800DM-6, A6800DM-7, A6800DM-8, A6800DM-9, A6800DM-5.5, A6800DM-10, A6800DM-11, A6800DM-12, A6800DM-13	
A7402DM-19, A7402DM-15, A7402DM-16, A7402DM-17, A7402DM-18, A7402DM-11, A7402DM-12, A7402DM-13, A7402DM-14, A7402DM-10	
6700SM-5.5, 6700SM-6, 6700SM-11, 6700SM-12, 6700SM-13, 6700SM-7, 6700SM-8, 6700SM-9, 6700SM-10	
6709M-3, 6709M-4, 6709M-5, 6709M-6, 6709M-8	
6709PH-1, 6709PH-2, 6709PH-3	
6709TORX-T20, 6709TORX-T25, 6709TORX-T27, 6709TORX-T30, 6709TORX-T8, 6709TORX-T9, 6709TORX-T10, 6709TORX-T15, 6709TORX-T40	
6954	
6956	
6958	
6960, 6961, 6962, 6962L	
6966	
6972H	
7400SM-6, 7400SM-11, 7400SM-12, 7400SM-13, 7400SM-14, 7400SM-7, 7400SM-8, 7400SM-9, 7400SM-10, 7400SM-19, 7400SM-22, 7400SM-15, 7400SM-16, 7400SM-17, 7400SM-18	
7407H	
7409M-8, 7409M-10, 7409M-4, 7409M-5, 7409M-6, 7409M-7, 7409M-3	
7409TORX-T25, 7409TORX-T27, 7409TORX-T30, 7409TORX-T40, 7409TORX-T45, 7409TORX-T50	
7750SL	
7761, 7762, 7760	
7764	
7765	
7766	
8164-1/2	
6950SL	

Skumplastinlägg med fasta nycklar, insexnycklar m.m. för 4750RCHDW01 extra kraftig hård väska – 39 delar



FF2B13



50 x 270 x 505 mm

1 FF2B13

BE-9770	
111M-12, 111M-13, 111M-14, 111M-15, 111M-8, 111M-9, 111M-10, 111M-11, 111M-6, 111M-7, 111M-21, 111M-22, 111M-16, 111M-17, 111M-18, 111M-19	
6M-6-7, 6M-8-9, 6M-10-11, 6M-12-13, 6M-14-15, 6M-16-17, 6M-18-19, 6M-20-22	
9070C	
1177-SCRIBE	
2535F2	
7758	
7754	

Skumplastinlägg med skruvmejslar för 4750RCHDW01 extra kraftig hård väska – 48 delar



FF2B14



35 x 270 x 505 mm

1 FF2B14

BE-8020L, BE-8030	
BE-8155	
BE-8260	
BE-8350	
BE-8601, BE-8602	
BE-8610, BE-8620	
BE-8630	
1544	
2047-0.8-4	
2047PR-1-2	
2058-BR	
2509	
808050P	
808050S	
59S/31-1	

Skumplastinlägg med tänger, mätverktyg etc för 4750RCHDW01 extra kraftig hård väska – 9 delar



FF2B15



35 x 270 x 505 mm



1 FF2B15

1150-1/2H/P	
2101GC-160IP	
2427 GC-200IP	
2430 GC-200 IP	
2628 GC-160IP	
2820EF2	
5515T-52	
8224CIP	
MTB-3-16-M-E	

Skumplastinlägg med hammare, dornar etc för 4750RCHDW01 extra kraftig hård väska – 6 delar



FF2B16



34 x 122 x 355 mm



1 FF2B16

3625W-35	
3734-3, 3734-5, 3734-8	
3735-4-120	
481-300	

Skumplastinlägg med 1/4" och 1/2" hylssats och multimeter för extra kraftig väska 4750RCHDW01 – 51 delar



FF2C01



45 x 390 x 530 mm



1 FF2C01

SBS81	
SL25	
BMMTRMS1	
S240	

Skumplastinlägg med verktygsset för extra kraftig hård väska – 15 delar



FF2A10



49 x 330 x 435 mm



1 FF2A10

2101GC-160IP	
2427 GC-200IP	
2628 GC-160IP	
2632	
2650	
2855	
2979 D-180	
3625N-32	
3734-2, 3734-3, 3734-4, 3734-5	
3735-4-120	
481-300	
8224CIP	

ARBETSBÄNK

Tålig arbetsbänk med bänkskiva i stål, hurts på ena sidan och 2 ben 1 500 mm x 750 mm x 1 030 mm



1495KCWB15TS



1030 x 750 x 1500 mm
1030 x 750 x 1500 mm
1030 x 750 x 1500 mm
1030 x 750 x 1500 mm
1030 x 750 x 1500 mm
1030 x 750 x 1500 mm
1030 x 750 x 1500 mm
1030 x 750 x 1500 mm
1030 x 750 x 1500 mm
1030 x 750 x 1500 mm
1030 x 750 x 1500 mm
1030 x 750 x 1500 mm



1 1495K6CWB15TS
1 1495K7CWB15TS
1 1495K8CWB15TS
1 1495K6CBKWB15TS
1 1495K7CBKWB15TS
1 1495K8CBKWB15TS
1 1495K6CBLWB15TS
1 1495K7CBLWB15TS
1 1495K8CBLWB15TS
1 1495K6CRDWB15TS
1 1495K7CRDWB15TS
1 1495K8CRDWB15TS

Tåliga stål arbetsbänkar med hög hurts på ena sidan och 2 ben 1800 mm x 750 mm x 1030 mm



1495KCWB18TS



1030 x 750 x 1800 mm
1030 x 750 x 1800 mm
1030 x 750 x 1800 mm
1030 x 750 x 1800 mm
1030 x 750 x 1800 mm
1030 x 750 x 1800 mm
1030 x 750 x 1800 mm
1030 x 750 x 1800 mm
1030 x 750 x 1800 mm
1030 x 750 x 1800 mm
1030 x 750 x 1800 mm
1030 x 750 x 1800 mm



1 1495K6CWB18TS
1 1495K7CWB18TS
1 1495K8CWB18TS
1 1495K6CBKWB18TS
1 1495K7CBKWB18TS
1 1495K8CBKWB18TS
1 1495K6CBLWB18TS
1 1495K7CBLWB18TS
1 1495K8CBLWB18TS
1 1495K6CRDWB18TS
1 1495K7CRDWB18TS
1 1495K8CRDWB18TS



Tålig arbetsbänk med bänkskiva i trä, hurts på ena sidan och 2 ben 1 500 mm x 750 mm x 1 030 mm



1495KCWB15TW



1030 x 750 x 1500 mm	1	1495K6CWB15TW
1030 x 750 x 1500 mm	1	1495K7CWB15TW
1030 x 750 x 1500 mm	1	1495K8CWB15TW
1030 x 750 x 1500 mm	1	1495K6CBKWB15TW
1030 x 750 x 1500 mm	1	1495K7CBKWB15TW
1030 x 750 x 1500 mm	1	1495K8CBKWB15TW
1030 x 750 x 1500 mm	1	1495K6CBLWB15TW
1030 x 750 x 1500 mm	1	1495K7CBLWB15TW
1030 x 750 x 1500 mm	1	1495K8CBLWB15TW
1030 x 750 x 1500 mm	1	1495K6CRDWB15TW
1030 x 750 x 1500 mm	1	1495K7CRDWB15TW
1030 x 750 x 1500 mm	1	1495K8CRDWB15TW

Tålig arbetsbänk i MDF med hög hurts på ena sidan och 2 ben 1 500 mm x 750 mm x 1 030 mm



1495KCWB15TD



1030 x 750 x 1500 mm	1	1495K6CWB15TD
1030 x 750 x 1500 mm	1	1495K7CWB15TD
1030 x 750 x 1500 mm	1	1495K8CWB15TD
1030 x 750 x 1500 mm	1	1495K6CBKWB15TD
1030 x 750 x 1500 mm	1	1495K7CBKWB15TD
1030 x 750 x 1500 mm	1	1495K8CBKWB15TD
1030 x 750 x 1500 mm	1	1495K6CBLWB15TD
1030 x 750 x 1500 mm	1	1495K7CBLWB15TD
1030 x 750 x 1500 mm	1	1495K8CBLWB15TD
1030 x 750 x 1500 mm	1	1495K6CRDWB15TD
1030 x 750 x 1500 mm	1	1495K7CRDWB15TD
1030 x 750 x 1500 mm	1	1495K8CRDWB15TD

Kraftig verktygsbänk med låg höjd, bänkskiva i stål, 6 lådor och två ben



1495KH6WBTS



880 x 750 x 1500 mm	1	1495KH6WB15TS
880 x 750 x 1800 mm	1	1495KH6WB18TS
880 x 750 x 1500 mm	1	1495KH6BKWB15TS
880 x 750 x 1800 mm	1	1495KH6BKWB18TS
880 x 750 x 1500 mm	1	1495KH6BLWB15TS
880 x 750 x 1800 mm	1	1495KH6BLWB18TS
880 x 750 x 1500 mm	1	1495KH6RDWB15TS
880 x 750 x 1800 mm	1	1495KH6RDWB18TS

Tålig arbetsbänk med bänkskiva i trä, hög hurts på ena sidan och 2 ben 1 800 mm x 750 mm x 1 030 mm



1495KCWB18TW



1030 x 750 x 1800 mm	1	1495K6CWB18TW
1030 x 750 x 1800 mm	1	1495K7CWB18TW
1030 x 750 x 1800 mm	1	1495K8CWB18TW
1030 x 750 x 1800 mm	1	1495K6CBKWB18TW
1030 x 750 x 1800 mm	1	1495K7CBKWB18TW
1030 x 750 x 1800 mm	1	1495K8CBKWB18TW
1030 x 750 x 1800 mm	1	1495K6CBLWB18TW
1030 x 750 x 1800 mm	1	1495K7CBLWB18TW
1030 x 750 x 1800 mm	1	1495K8CBLWB18TW
1030 x 750 x 1800 mm	1	1495K6CRDWB18TW
1030 x 750 x 1800 mm	1	1495K7CRDWB18TW
1030 x 750 x 1800 mm	1	1495K8CRDWB18TW

Tålig arbetsbänk i MDF med hög hurts på ena sidan och 2 ben 1 800 mm x 750 mm x 1 030 mm



1495KCWB18TD



1030 x 750 x 1800 mm	1	1495K6CWB18TD
1030 x 750 x 1800 mm	1	1495K7CWB18TD
1030 x 750 x 1800 mm	1	1495K8CWB18TD
1030 x 750 x 1800 mm	1	1495K6CBKWB18TD
1030 x 750 x 1800 mm	1	1495K7CBKWB18TD
1030 x 750 x 1800 mm	1	1495K8CBKWB18TD
1030 x 750 x 1800 mm	1	1495K6CBLWB18TD
1030 x 750 x 1800 mm	1	1495K7CBLWB18TD
1030 x 750 x 1800 mm	1	1495K8CBLWB18TD
1030 x 750 x 1800 mm	1	1495K6CRDWB18TD
1030 x 750 x 1800 mm	1	1495K7CRDWB18TD
1030 x 750 x 1800 mm	1	1495K8CRDWB18TD

Kraftig verktygsbänk med låg höjd, bänkskiva i stål, 7 lådor och två ben



1495KH7WBTS



880 x 750 x 1500 mm	1	1495KH7WB15TS
880 x 750 x 1800 mm	1	1495KH7WB18TS
880 x 750 x 1500 mm	1	1495KH7BKWB15TS
880 x 750 x 1800 mm	1	1495KH7BKWB18TS
880 x 750 x 1500 mm	1	1495KH7BLWB15TS
880 x 750 x 1800 mm	1	1495KH7BLWB18TS
880 x 750 x 1500 mm	1	1495KH7RDWB15TS
880 x 750 x 1800 mm	1	1495KH7RDWB18TS

Kraftig verktygsbänk med låg höjd, bänkskiva i stål, 8 lådor och två ben



1495KH8WBTS



880 x 750 x 1500 mm	1	1495KH8WB15TS
880 x 750 x 1800 mm	1	1495KH8WB18TS



880 x 750 x 1500 mm	1	1495KH8BKWB15TS
880 x 750 x 1800 mm	1	1495KH8BKWB18TS
880 x 750 x 1500 mm	1	1495KH8BLWB15TS
880 x 750 x 1800 mm	1	1495KH8BLWB18TS
880 x 750 x 1500 mm	1	1495KH8RDWB15TS
880 x 750 x 1800 mm	1	1495KH8RDWB18TS



Kraftig verktygsbänk med låg höjd, bänkskiva i trä, 8 lådor och två ben



1495KH8WB15TS



880 x 750 x 1500 mm	1	1495KH8WB15TW
880 x 750 x 1800 mm	1	1495KH8WB18TW
880 x 750 x 1500 mm	1	1495KH8BKWB15TW
880 x 750 x 1800 mm	1	1495KH8BKWB18TW
880 x 750 x 1500 mm	1	1495KH8BLWB15TW
880 x 750 x 1800 mm	1	1495KH8BLWB18TW
880 x 750 x 1500 mm	1	1495KH8RDWB15TW
880 x 750 x 1800 mm	1	1495KH8RDWB18TW

Kraftig verktygsbänk med låg höjd, bänkskiva i trä, 6 lådor och två ben



1495KH6WB15TW



880 x 750 x 1500 mm	1	1495KH6WB15TW
880 x 750 x 1800 mm	1	1495KH6WB18TW
880 x 750 x 1500 mm	1	1495KH6BKWB15TW
880 x 750 x 1800 mm	1	1495KH6BKWB18TW
880 x 750 x 1500 mm	1	1495KH6BLWB15TW
880 x 750 x 1800 mm	1	1495KH6BLWB18TW
880 x 750 x 1500 mm	1	1495KH6RDWB15TW
880 x 750 x 1800 mm	1	1495KH6RDWB18TW

Kraftig verktygsbänk med låg höjd, bänkskiva i MDF, 6 lådor och två ben



1495KH6WB15TD



880 x 750 x 1500 mm	1	1495KH6WB15TD
880 x 750 x 1800 mm	1	1495KH6WB18TD
880 x 750 x 1500 mm	1	1495KH6BKWB15TD
880 x 750 x 1800 mm	1	1495KH6BKWB18TD
880 x 750 x 1500 mm	1	1495KH6BLWB15TD
880 x 750 x 1800 mm	1	1495KH6BLWB18TD
880 x 750 x 1500 mm	1	1495KH6RDWB15TD
880 x 750 x 1800 mm	1	1495KH6RDWB18TD

Kraftig verktygsbänk med låg höjd, bänkskiva i trä, 7 lådor och två ben



1495KH7WB15TW



880 x 750 x 1500 mm	1	1495KH7WB15TW
880 x 750 x 1800 mm	1	1495KH7WB18TW
880 x 750 x 1500 mm	1	1495KH7BKWB15TW
880 x 750 x 1800 mm	1	1495KH7BKWB18TW
880 x 750 x 1500 mm	1	1495KH7BLWB15TW
880 x 750 x 1800 mm	1	1495KH7BLWB18TW
880 x 750 x 1500 mm	1	1495KH7RDWB15TW
880 x 750 x 1800 mm	1	1495KH7RDWB18TW

Kraftig verktygsbänk med låg höjd, bänkskiva i MDF, 7 lådor och två ben



1495KH7WB15TD



880 x 750 x 1500 mm	1	1495KH7WB15TD
880 x 750 x 1800 mm	1	1495KH7WB18TD



880 x 750 x 1500 mm	1	1495KH7BKWB15TD
880 x 750 x 1800 mm	1	1495KH7BKWB18TD
880 x 750 x 1500 mm	1	1495KH7BLWB15TD
880 x 750 x 1800 mm	1	1495KH7BLWB18TD
880 x 750 x 1500 mm	1	1495KH7RDWB15TD
880 x 750 x 1800 mm	1	1495KH7RDWB18TD

Kraftig verktygsbänk med låg höjd, bänkskiva i MDF, 8 lådor och två ben



1495KH8WB15TD



880 x 750 x 1500 mm	1	1495KH8WB15TD
880 x 750 x 1800 mm	1	1495KH8WB18TD
880 x 750 x 1500 mm	1	1495KH8BKWB15TD
880 x 750 x 1800 mm	1	1495KH8BKWB18TD
880 x 750 x 1500 mm	1	1495KH8BLWB15TD
880 x 750 x 1800 mm	1	1495KH8BLWB18TD
880 x 750 x 1500 mm	1	1495KH8RDWB15TD
880 x 750 x 1800 mm	1	1495KH8RDWB18TD

Bänkskivesats i stål för konvertering av Bahco-vagnar i 1475K-serien till arbetsbänkar



1495KW-TS



1030 x 750 x 1500 mm	1	1495KW15TS
1030 x 750 x 1800 mm	1	1495KW18TS



Robust bänkskivesats i kastanträ för konvertering av Bahco-vagnar i 1475k-serien till arbetsbänkar



1495KWB-TW



1030 x 750 x 1500 mm	1	1495KWB15TW
1030 x 750 x 1800 mm	1	1495KWB18TW

Tålig arbetsbänk med bänkskiva i kastanträ, fyra ben



1495WB-TW



1030 x 750 x 1500 mm	1	1495WB15TW
1030 x 750 x 1800 mm	1	1495WB18TW
1030 x 750 x 1500 mm	1	1495WB15TWGR
1030 x 750 x 1800 mm	1	1495WB18TWGR

Extra kraftig arbetsbänk med bänkskiva i stål och nederdel med fyra ben – 1 800 mm



1495WB18TSBT



1030 x 750 x 1800 mm	1	1495WB18TSBT
1030 x 750 x 1800 mm	1	1495WB18TSBLBT

Bänkskivesats MDF för vagnar i 1475k-serien



1495KWB-TD



1030 x 750 x 1500 mm	1	1495KWB15TD
1030 x 750 x 1800 mm	1	1495KWB18TD

Tålig arbetsbänk med bänkskiva av MDF, med fyra ben



1495WB-TD



1030 x 750 x 1500 mm	1	1495WB15TD
1030 x 750 x 1800 mm	1	1495WB18TD
1030 x 750 x 1500 mm	1	1495WB15TDGR
1030 x 750 x 1800 mm	1	1495WB18TDGR

Tåliga arbetsbänkar med stålskiva med justerbar höjd och fyra ben



1495WBAH-TS



850 x 750 x 1500 mm	1	1495WBAH15TS
850 x 750 x 1500 mm	1	1495WBAH15TSBL
850 x 750 x 1800 mm	1	1495WBAH18TS
850 x 750 x 1800 mm	1	1495WBAH18TSBK
850 x 750 x 1800 mm	1	1495WBAH18TSBL
850 x 750 x 1800 mm	1	1495WBAH18TSRED

Tålig arbetsbänk med bänkskiva i stål, fyra ben



1495WB-TS



1030 x 750 x 1500 mm	1	1495WB15TS
1030 x 750 x 1800 mm	1	1495WB18TS
1030 x 750 x 1500 mm	1	1495WB15TSBK
1030 x 750 x 1800 mm	1	1495WB18TSBK
1030 x 750 x 1500 mm	1	1495WB15TSBL
1030 x 750 x 1800 mm	1	1495WB18TSBL
1030 x 750 x 1500 mm	1	1495WB15TSRED
1030 x 750 x 1800 mm	1	1495WB18TSRED

Extra kraftig arbetsbänk med bänkskiva i stål och nederdel med fyra ben – 1 500 mm



1495WB15TSBT



1030 x 750 x 1500 mm	1	1495WB15TSBT
----------------------	---	--------------

Tåliga arbetsbänkar med skiva av kastanträ och justerbar höjd med fyra ben



1495WBAH-TW



850 x 750 x 1500 mm	1	1495WBAH15TW
850 x 750 x 1800 mm	1	1495WBAH18TW
850 x 750 x 1800 mm	1	1495WBAH18TWGR

Tålig arbetsbänk med bänkskiva av MDF, med justerbar höjd och fyra ben



1495WBAH-TD



850 x 750 x 1500 mm	1	1495WBAH15TD
850 x 750 x 1800 mm	1	1495WBAH18TD

Hopfällbara bänkskivor, galvaniserade/MDF



1495FWBTD



840 x 510 x 970 mm	1	1495FWB097TD
840 x 510 x 1200 mm	1	1495FWB120TD

Galvaniserade hopfällbara bänkskivor



1495FWBTS



840 x 510 x 970 mm	1	1495FWB097TS
840 x 510 x 1200 mm	1	1495FWB120TS

Nedre hyllor i rostfritt stål för 1495WB arbetsbänkar



1495WB1-AC



30 x 504 x 1500 mm	1	1495WB15-AC1
30 x 504 x 1800 mm	1	1495WB18-AC1
30 x 500 x 1500 mm	1	1495WB15-AC1GR
30 x 504 x 1800 mm	1	1495WB18-AC1GR

Utdragslådor med hyllor eller avdelare för 1495WB arbetsbänkar



1495WB-AC



105 x 500 x 500 mm	1	1495WB-AC1
160 x 528 x 570 mm	1	1495WB-AC2

VERKTIGSSKÅP OCH VERKTIGSTAVLOR

Vägg- eller bänkmonterat skåp med jalusi



1495CS1



900 x 170 x 1500 mm	1	1495CS15
900 x 170 x 1800 mm	1	1495CS18
900 x 170 x 1500 mm	1	1495CS15BK
900 x 170 x 1800 mm	1	1495CS18BK
900 x 170 x 1500 mm	1	1495CS15BL
900 x 170 x 1800 mm	1	1495CS18BL
900 x 170 x 1500 mm	1	1495CS15RED
900 x 170 x 1800 mm	1	1495CS18RED

Vägg- eller bänkmonterat skåp med jalusi och krokar



1495CS18HK



900 x 170 x 1800 mm	1	1495CS18HK
900 x 170 x 1800 mm	1	1495CS18BLHK

Tåliga verktygspaneler med förstärkt kant

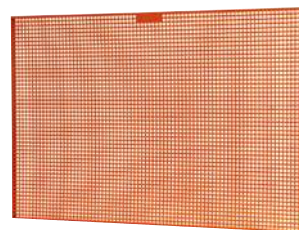

1495TP



500 x 23 x 600 mm	1	1495TP06
800 x 25 x 1200 mm	1	1495TP12
800 x 23 x 1500 mm	1	1495TP15
800 x 23 x 1800 mm	1	1495TP18
500 x 25 x 600 mm	1	1495TP06GR
800 x 25 x 1200 mm	1	1495TP12GR
800 x 25 x 1495 mm	1	1495TP15GR
800 x 25 x 1800 mm	1	1495TP18GR

Extra kraftiga verktygspaneler för upphängning med förstärkt kant

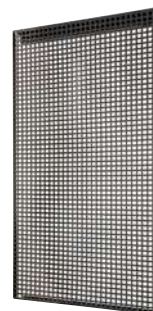

1495TP09



900 x 25 x 500 mm	1	1495TP09
-------------------	---	----------



Verktygspanel på hjul



1495TP10W



1500 x 450 x 1000 mm

1 1495TP10W

2-dörrars verktygsskåp för väggmontering



1495CD60



900 x 250 x 602 mm
900 x 250 x 602 mm
900 x 250 x 602 mm
900 x 250 x 602 mm

1 1495CD60
1 1495CD60BK
1 1495CD60BL
1 1495CD60RED

2-dörrars verktygsskåp med hjul



1495CD60W



1605 x 450 x 625 mm
1605 x 450 x 625 mm
1605 x 450 x 625 mm
1605 x 450 x 625 mm

1 1495CD60W
1 1495CD60WBK
1 1495CD60WBL
1 1495CD60WRED

Kroksats för skåp och panel 1495-24 delar

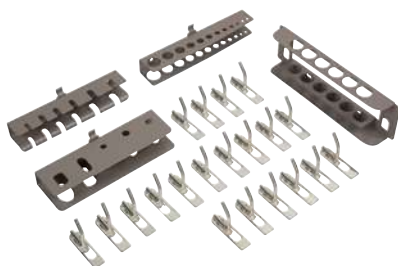

1495CD-AC1



1.22 kg



1 1495CD-AC1

Kroksats för skåp och panel 1495-35 delar

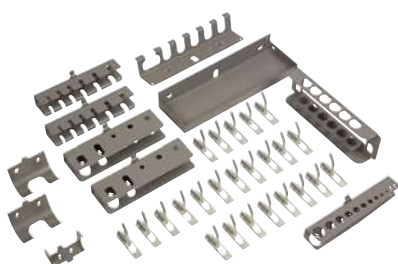

1495CS-AC1



2.11 kg



1 1495CS-AC1

Adapter för verktygspanel, för arbetsbänkar i trä och MDF



1495TP-AC1



9.5 kg



1 1495TP-AC1

Hållare för 12 st u-ringnycklar, för verktygstavlor



1495TP-AC10



0.43 kg



1 1495TP-AC10

Hållare för 6 st sprintutdrivare, för verktygstavlor

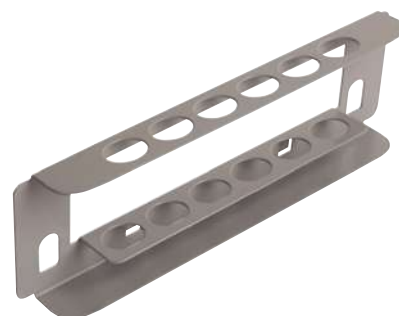

1495TP-AC11



0.16 kg



1 1495TP-AC11

Hållare för hammare, för verktygstavlor



1495TP-AC12



0.07 kg



1 1495TP-AC12

Hållare för t-handtag, för verktygstavlor



1495TP-AC13

kg 0.04 kg 1 1495TP-AC13

Plasthylla för verktygstavlor



1495TP-AC4

kg 0.125 kg 1 1495TP-AC4

Krok för verktygstavlor



1495TP-AC7

kg 0.79 kg 1 1495TP-AC7

Hylla för verktygspaneler



1495TP-AC2

kg 0.44 kg 1 1495TP-AC2

Hållare för 6 skruvmejslar, med krok, för verktygstavlor

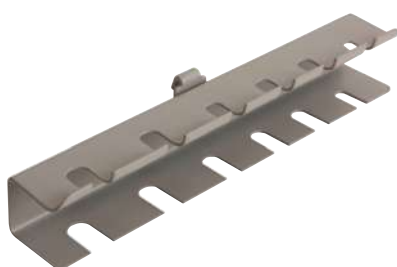

1495TP-AC5

kg 0.14 kg 1 1495TP-AC5

Hållare för 12 insexnycklar, för verktygstavlor

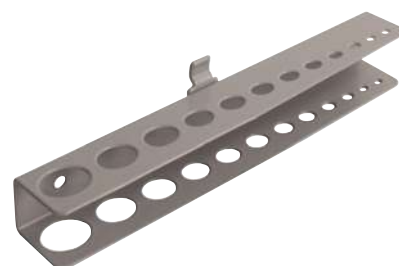

1495TP-AC8

kg 0.12 kg 1 1495TP-AC8

Sats med krok och bricka för hylsor, för verktygstavlor



1495TP-AC3

kg 0.45 kg 1 1495TP-AC3

Hållare för 6 tänger, med krok, för verktygstavlor



1495TP-AC6

kg 0.17 kg 1 1495TP-AC6

Krokar för 12 st dubbla hylsnycklar, för verktygspaneler



1495TP-AC9

kg 0.43 kg 1 1495TP-AC9



Sats med krokar för verktygstavlor – 5 st



1495TP-ACH

kg	
0.116 kg	1 1495TP-ACHL20
0.125 kg	1 1495TP-ACHL40
0.144 kg	1 1495TP-ACHL65
0.17 kg	1 1495TP-ACHL90
0.102 kg	1 1495TP-ACHU20
0.125 kg	1 1495TP-ACHU40
0.146 kg	1 1495TP-ACHU65
0.162 kg	1 1495TP-ACHU90

Skena för upphängning av 1495TP09-paneler



1495TP09-RAIL

40 x 57 x 440 mm	1 1495TP09-RAIL

VERKTYGSLÅDOR I METALL

Verktygslåda i metall, med 3 lådor



1483KHD3RB

	g	
305 x 233 x 523 mm	13050 g	1 1483KHD3RB

Extra kraftig verktygslåda i metall, med 4 lådor



1483KHD4RB

	g	
390 x 260 x 593 mm	15200 g	1 1483KHD4RB

Verktygslåda i metall, med 3 lådor



1484THD3RB

	kg	
300 x 220 x 520 mm	12.40 kg	1 1484THD3RB

Verktygslåda i metall, med 2 lådor



1483K2RB

	g	
277 x 257 x 525 mm	8200 g	1 1483K2RB

Verktygslåda i metall med 3 lådor



1483K3RB

	g	
334 x 260 x 523 mm	10200 g	1 1483K3RB

Vagn för metallåda 1483K



1483CART

	kg	
200 x 270 x 655 mm	6.02 kg	1 1483CART

Låda för murarverktyg 530 mm x 290 mm x 290 mm



1496MB2

	kg	
290 x 290 x 530 mm	40 kg	1 1496MB2

Låda för murarverktyg 690 mm x 360 mm x 310 mm



1496MB3



310 x 360 x 690 mm 60 kg 1 1496MB3

Låda för murarverktyg 100 mm x 170 mm x 573 mm



1497MB08

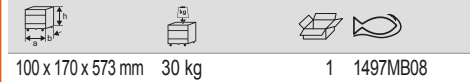

100 x 170 x 573 mm 30 kg 1 1497MB08

Verktvagslådor i metall med 5 fack och låsmöjlighet



3149-OR

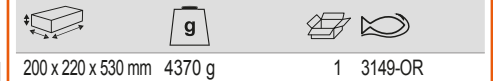

200 x 220 x 530 mm 4370 g 1 3149-OR

Låda för murarverktyg 830 mm x 440 mm x 340 mm



1496MB4

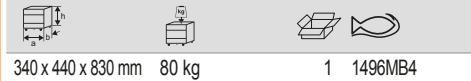

340 x 440 x 830 mm 80 kg 1 1496MB4

Låda för murarverktyg 100 mm x 230 mm x 605 mm



1497MB13



100 x 230 x 605 mm 1 1497MB13

Verktvagslådor i metall med 3/5 fack och låsmöjlighet



9601



190 x 210 x 300 mm 2450 g 1 960100010
 190 x 210 x 400 mm 3400 g 1 960100020
 190 x 210 x 500 mm 3670 g 1 960100030
 245 x 210 x 400 mm 4400 g 1 960100050
 245 x 210 x 500 mm 4840 g 1 960100060

Låda för murarverktyg 910 mm x 530 mm x 530 mm



1496MB5



530 x 530 x 910 mm 150 kg 1 1496MB5

Låda för murarverktyg 122 mm x 270 mm x 640 mm



1497MB18



122 x 270 x 640 mm 30 kg 1 1497MB18

Verktvagslåda i plåt, 3 fack



1497MBF350



160 x 200 x 530 mm 10 kg 1 1497MBF350



Verktyslåda i plåt, 5 fack



1497MBF550



200 x 200 x 530 mm 12 kg 1 1497MBF550

24 l verktysväska i textil, öppen upptill med hård botten



3100TB



345 x 240 x 485 mm 1 3100TB

32 l verktysväskor i textil som stängs upptill och har hård botten



4750FB2-19A



370 x 230 x 470 mm 4 4750FB2-19A

Verktyslåda i plåt, 7 fack



1497MBF750



250 x 200 x 530 mm 15 kg 1 1497MBF750

32 l verktysväskor i tyg öppna upptill och med styv botten



4750FB1-19A



355 x 230 x 470 mm 1 4750FB1-19A

48 l verktyslådor i textil som stängs upptill och har hård botten



4750FB2-24A



380 x 260 x 600 mm 2 4750FB2-24A

TEXTIL- OCH LÄDERUTRUSTNING

Ryggsäck med halkfri hård botten i plast



4750FB8



560 x 190 x 335 mm 4 4750FB8

32 l verktysväskor av exklusiv textil, öppna upptill med hård botten



4750FB1-19B



365 x 225 x 480 mm 4 4750FB1-19B

73 l verktysväskor i textil med hjul och teleskophandtag



4750FB2W-24A



385 x 325 x 665 mm 1 4750FB2W-24A

12 l textilväskor för elektrikerverktyg



4750FB3-12



285 x 190 x 285 mm



1 4750FB3-12

Verktgsväska som kan stängas upp till, volym 36 liter



4750FB6-19



290 x 265 x 480 mm



1 4750FB6-19

Verktgsporfölj i textil, 2,38 L



4750SF-1



0,96 kg



55 x 220 x 485 mm



1 4750SF-1

17 l laptop- och verktgsväskor



4750FB4-18



350 x 150 x 430 mm



4 4750FB4-18

Verktgsväska i textil för 416-SET-1



4750LV-1



85 x 43 x 1800 mm

51 x 43 x 1800 mm



1 4750LV-1

1 4750LV-2

Verktgsporfölj i textil, 2,9 L



4750SF-2



60 x 265 x 485 mm



1 4750SF-2

Verktgsväska som kan stängas upp till, volym 21 liter



4750FB6-13



275 x 250 x 310 mm



1 4750FB6-13

24 L verktgsväska i textil med hård botten, öppen upp till – 9 delar, display



3100TB-DISP



300 x 555 x 715 mm



1 3100TB-DISP

2,4 L litet textiletui med verktyg



4750FB5A



50 x 168 x 273 mm



1 4750FB5A



6 L medelstort textiletui med gummigrepp



4750FB5B



62 x 275 x 330 mm



1 4750FB5B

11 L textiletui med verktyg och gummigrepp för 2x 1/3 Fit&Go skumplastinlägg



4750FB5-FG2



90 x 210 x 470 mm



1 4750FB5-FG2

Verktögsväska i läder, för elektriker



4750-VDEC



290 x 190 x 445 mm



1 4750-VDEC

12 L stort textiletui med gummigrepp



4750FB5C



80 x 305 x 403 mm



8 4750FB5C

Verktögsväska i läder



4750-FOLT-C-1



290 x 195 x 440 mm



1 4750-FOLT-C-1

Sats med 3 st. blixtlåspåsar – 90 mm



4750FB7-01



135 x 10 x 215 mm



60 4750FB7-01

8 L textiletui med verktyg och gummigrepp för 1x 1/3 Fit&Go skumplastinlägg



4750FB5-FG1



65 x 210 x 470 mm



1 4750FB5-FG1

Verktögsväskor, rund modell



4750-TOCST-1



220 x 170 x 495 mm



1 4750-TOCST-1

Sats med 3 st. blixtlåspåsar – 145 mm



4750FB7-02



205 x 10 x 310 mm



60 4750FB7-02

BAHCO

Orange blixtlåspåse – 90 mm



4750FB7ORLT



135 x 10 x 215 mm



120 4750FB7ORLT

Kraftigt bälte med stopning och rostfritt spänne



4750-HDB-2



190 x 50 x 900 mm



1 4750-HDB-2

Juniorbältessett med tre fickor



4750-JU3PB



125 x 55 x 395 mm



1 4750-JU3PB-1

Orange blixtlåspåse – 145 mm



4750FB7ORBG



205 x 10 x 310 mm



120 4750FB7ORBG

Kraftigt verktygsbältesset



4750-HDBS-2



330 x 170 x 900 mm



1 4750-HDBS-2

Extra kraftigt läderbälte



4750-HDLB



47 x 4 x 1380 mm



1 4750-HDLB-1

Bältessett med tre fickor, passar för midja upp till 48"



4750-3PB



234 x 105 x 570 mm



1 4750-3PB-1

Textilbälte med snabblossning



4750-QRFB-1



50 x 4 x 1180 mm



1 4750-QRFB-1

Verktygsficka med två fack för utrustningsdetaljer



4750-2PP



285 x 130 x 265 mm



1 4750-2PP-1



Verktögsfickor



4750-UP



302 x 140 x 250 mm



1 4750-UP-1

Allroundhållare



4750-MPH-1



240 x 50 x 155 mm



1 4750-MPH-1

Vertikal hållare för mobiltelefon



4750-VMPH-1



170 x 35 x 100 mm



1 4750-VMPH-1

Borrhölster för vänster- och högerhänta



4750-DHO-3



320 x 73 x 175 mm



1 4750-DHO-3

Hölster för universalkniv



4750-KNHO-1



205 x 35 x 105 mm



1 4750-KNHO-1

Bindel för verktyg



4750-ROCO-1



320 x 5 x 370 mm



1 4750-ROCO-1

Elektrikerväsor



4750-EP



345 x 120 x 260 mm



1 4750-EP-1

Knivhölster för knivar i ERGO™-serien



4750-KNHO-0



200 x 10 x 85 mm



1 4750-KNHO-0

Knäskydd för golv- och takläggning



4750-KP



210 x 50 x 175 mm

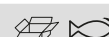

1 4750-KP-1

Svart sekretörhölster i läder



PROF-TL



30 x 90 x 245 mm



4 PROF-TL

Hängslen med klämfästen



4750-BWC-1



750 x 20 x 105 mm



1 4750-BWC-1

PLASTLÅDOR OCH VÄSKOR

500 mm slitstarka verktyglådor av plast



4750PTB50



27 l



20 kg



3 4750PTB50

600 mm slitstarka verktyglådor av plast



4750PTB60



37 l



20 kg



3 4750PTB60

470 mm slitstarka verktyglådor av plast



4750PTBW47



60 l



30 kg



1 4750PTBW47

Extra kraftiga verktyglådor i plast, 650 mm



4750PTB65



285 x 300 x 650 mm



2 4750PTB65

Slitstarka verktyglådor av plast, 670 mm



4750PTBW67



420 x 472 x 675 mm



50 kg



1 4750PTBW67

Låda med dubbla stötdämpande väggar



4750BMC



51 x 117 x 260 mm



1 4750BMC3

67 x 214 x 230 mm

1 4750BMC4

70 x 230 x 280 mm

1 4750BMC5

90 x 230 x 320 mm

1 4750BMC5.5

93 x 257 x 357 mm

1 4750BMC6

76 x 256 x 355 mm

1 4750BMC7

80 x 287 x 380 mm

1 4750BMC9

105 x 297 x 393 mm

1 4750BMC9.5

84 x 341 x 450 mm

1 4750BMC10



VERKTYGSSATSER

Allroundverktygssats i hård väska – 109 delar



2010



109 480 x 180 x 330 mm 1 2010

1952M-6, 1952M-7, 1952M-8, 1952M-9, 1952M-10, 1952M-11, 1952M-12, 1952M-13, 1952M-14	
4020L-M-3, 4020L-M-3.2, 4020L-M-3.5, 4020L-M-4, 4020L-M-4.5, 4020L-M-5.5	
BE-8340, BE-8350, BE-8355	
700-1.5-50, 700-1.2-50, 700-1-50, 700-1.8-50	
3659/8T	
5550-3.2, 5550-4.5	
BE-8220S, BE-8050S, BE-8255S	
5516 I	
5577-145	
5418	
2535L	
3524	
2648	
1150-1/2H/P	
1952Z-1/4, 1952Z-3/8, 1952Z-1/2	
BE-8620S	
BE-7845, BE-7806	
701-0-50, 701-00-50	
8045LVDE	
5574-145	
2-470-16-1-0x 6	
5515GV	
5423	
326000300	
328000000	
2656 R	
BE-3529	
BE-6400M-4, BE-6400M-5, BE-6400M-5.5, BE-6400M-7	
BE-8160	
BE-8600, BE-8610	
1995LM-1.5, 1995LM-2, 1995LM-2.5, 1995LM-3, 1995LM-4	
1997M/10T	
2047-0.8-4, 2047-1-5.5	
2421 D-140IP	

2430 GC-200 IP	
2530-40	
2744	
4750RC021	
7372I-2.5-75	
8070 C	
2223 S-150	

Elektrikerväska i läder, 28 delar



3049-2



180 x 435 x 270 mm 1 3049-2

268	
5470-140	
111M-7, 111M-8, 111M-10, 111M-13	
2744	
2427 S-200	
8045LVDE	
BE-9765	
2705R	
481-300	
9072 P	
2628 S-180	
2101S-160	
BE-8820S	
BE-8220S, BE-8040S, BE-8050S, BE-8255S	
BE-8610S, BE-8620S	
B146.006.100	
4750-FOLTC-1	

Läderväska med verktygssats för elektriker-16 st



982000170



290 x 195 x 440 mm 1 982000170

4750-FOLTC-1	
2101GC-160IP	
2800 N	
2630GC-160IP	
2421GC-160	
2521GC-160	
8071 C IP	
B196.065.150, B196.055.125, B196.030.100, B196.040.100	
B197.002.100, B197.001.080	
SC127	
2820EF2	
MTB-3-16	
6224	

Verktygsväska i textil med verktygssats – 51 delar



4750FB4-18TS001



450 mm 190 mm 1 4750FB4-18TS001

4750FB4-18	
2101G-160	
2628 G-180	
2430 G-160	
1RM/SH8	
7223	
2233 D-200	
SL25	
9070	
9031	
483-20	
BE-8020, BE-8040	
BE-8150, BE-8155	
BE-8610, BE-8620	
SC127	
SQZ150003	
BE-9777	
MTB-5-25	

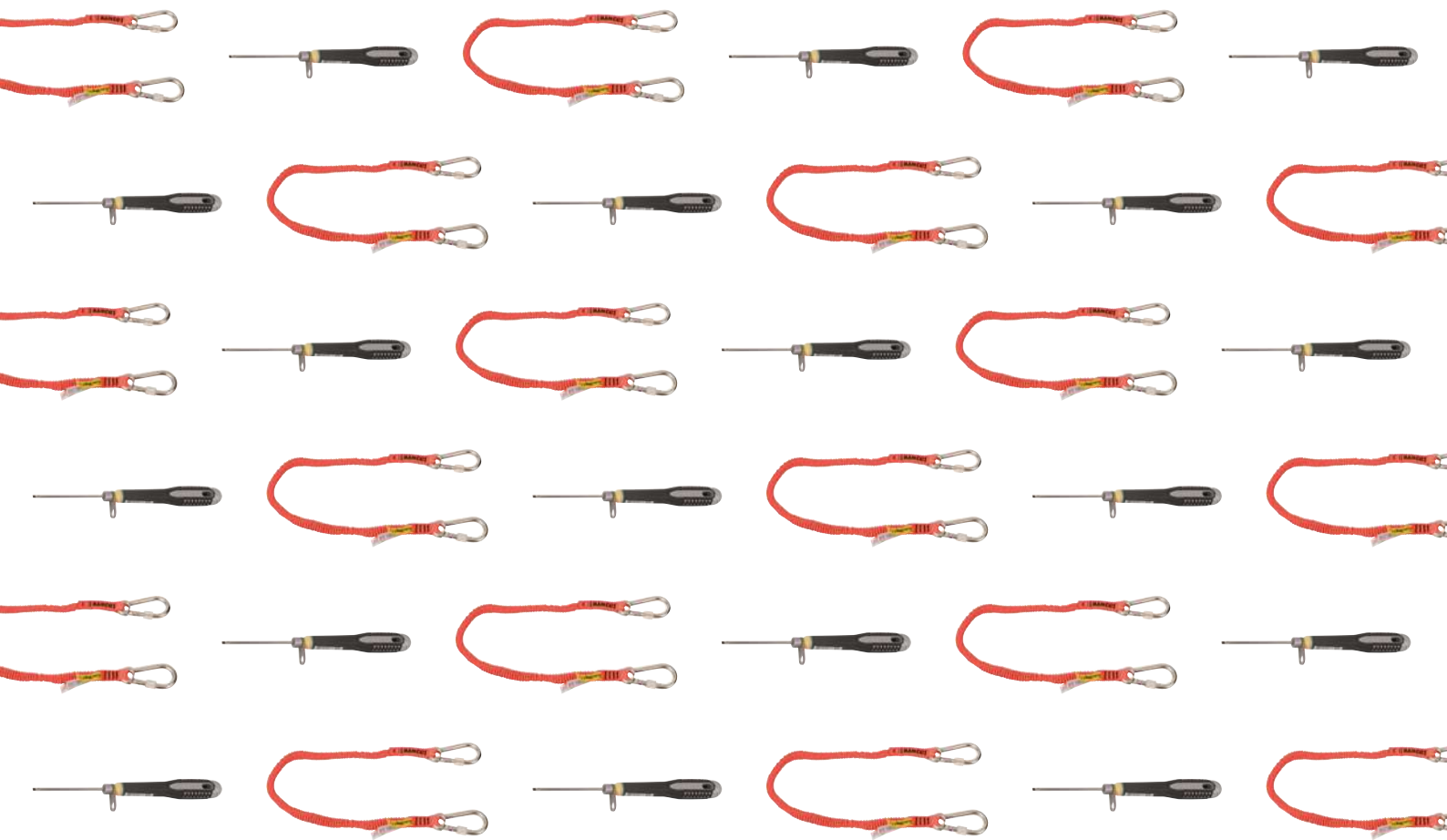

Verktyg för arbete på hög höjd



VERKTYGSFÖRVARING OCH SÄKERHETSLINOR

Orange säkerhetslina som syns bra, med vridbar karbinhake, 1 kg



3875-LY60



135 g



1 3875-LY60



Säkerhetslina med fastsydd karbinhake och utbyttbar stropp, 1 kg



3875-LY3



125 g



8 3875-LY3

Handledssnodd med utbyttbar ögla och dragsko, 1 kg



3875-WL1



40 g



8 3875-WL1

Ögla med fäste, för säkerhetslina



3875-QL1



40 g



8 3875-QL1

Orange säkerhetslina som syns bra, med fastsydd karbinhake, 3 kg



3875-LY70



172 g



1 3875-LY70



Utdragbar säkerhetslina med fastsydd karbinhake, 0,9 kg



3875-RL1



200 g



1 3875-RL1

Säkerhetslina med fastsydd karbinhake och låsanordning, 3 kg



3875-LY4



180 g



8 3875-LY4



Fästögla för utdragbar säkerhetslina



3875-QRL1



40 g



1 3875-QRL1

Säkerhetslina med fastsydd karbinhake, 3 kg



3875-LY1



170 g



8 3875-LY1

Utdragbar säkerhetslina med fastsydd karbinhake, 1 kg



3875-RL2



212 g



1 3875-RL2

Säkerhetslinor med fast karbinhake och fast ögla, 3 kg



3875-LY2



120 g



8 3875-LY2



Orange säkerhetslina som syns bra, med fastsydd karbinhake, 6 kg



3875-LY8



330 g



1 3875-LY8

Orange säkerhetslina som syns bra, med fastsydd karbinhake och max verktygsvikt 12 kg



3875-LY10



270 g



1 3875-LY10

Spiralsäkerhetslinor med 1 mm fäste



439000000



100 g



1 439000000

Spirallina med 1,5 mm vajeröglå



439000001



130 g



1 439000001

Säkerhetslina av stål vajer



3875-SL1



10 g



1 3875-SL1

Säkerhetslina i rulle med vridbar karbinhake, 3 kg



439000003



160 g



1 439000003

Orange säkerhetslina som syns bra, med plastklämma



439000004



13 g



1 439000004

Spiralsäkerhetslinor med 1 mm fäste



439000002



130 g



1 439000002

Rullad säkerhetslina med vridbar karbinhake, 2 kg



3875-HB10



260 x 130 x 130 mm



1 3875-HB10

Transportsäck, för arbete på hög höjd



3875-HB10



Transportsäck med förstärkta lyftremmar



3875-HB30/3875-HB60

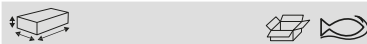

270 x 270 x 350 mm
350 x 350 x 640 mm

1 3875-HB30
8 3875-HB60

14 L ryggsäck i tålig polyester



3875-BP1



100 x 300 x 400 mm

8 3875-BP1

Verktygsväska med två stora fack och 6 ringar för infästning av verktygslinor



3875-MHP6



10 x 200 x 380 mm

1 3875-MHP6

Transportsäck med dubbelförstärkta lyftremmar



3875-HB100



400 x 400 x 900 mm

1 3875-HB100

24 L ryggsäck i tålig polyester



3875-BP2



210 x 330 x 450 mm

8 3875-BP2

Verktygsbälte med 3 fickor och 4 ringar för fastsättning av säkerhetslinor



3PB-2

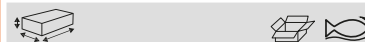

100 x 380 x 630 mm

1 4750-3PB-2

Formstabil transportkasse med dubbelförstärkta lyftremmar



3875-SB70



730 x 300 x 500 mm

1 3875-SB70

Verktygsväska med två stora fack och 4 ringar för infästning av verktygslinor



3875-MHP4

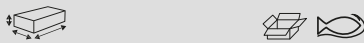

70 x 200 x 400 mm

1 3875-MHP4

Borrhölster med en ring för infästning av verktygslina



4750-DHO-4



300 x 150 x 270 mm

1 4750-DHO-4

Väska för måttband på 5 och 8 m med en ring för infästning av verktygslina



4750-MTHO-TAH



70 x 105 x 230 mm



1 4750-MTHO-TAH

Verktygsväska i universalmodell, med 2 stora fickor och 4 fästringar för säkerhetslinor



4750-UP-2



300 x 150 x 300 mm



1 4750-UP-2

Hammarhållare med en ring för infästning av verktygslina



4750-HHO-2



120 x 70 x 180 mm



1 4750-HHO-2

Kraftigt bälte med 6 ringar för fästning av säkerhetslinor



4750-HDLB-TAH



50 x 120 x 460 mm



1 4750-HDLB-TAH

DRAGVERKTYG

ERGO™ skiftnyckel ur 90-serien med snabbfäste



ergo



TAH90



158mm/6"
250mm/10"



20 mm
31 mm



1 TAH9070
1 TAH9072

Ställningsnyckel/skiftnyckel med fäste för säkerhetslinor



TAH84



405mm/16"



41 mm



1 TAH84-PODGER

U-ringnyckel med säkerhetsfjäder



TAH111M



6 mm
7 mm
8 mm
9 mm
10 mm
11 mm
12 mm
13 mm
14 mm
15 mm
16 mm
17 mm
18 mm
19 mm
20 mm
21 mm
22 mm
23 mm
24 mm
25 mm
27 mm
30 mm
32 mm
34 mm
36 mm
41 mm
46 mm
50 mm
55 mm
85 mm



112 mm
120 mm
130 mm
136 mm
144 mm
153 mm
160 mm
165 mm
177 mm
185 mm
195 mm
200 mm
208 mm
215 mm
240 mm
250 mm
250 mm
270 mm
270 mm
290 mm
310 mm
330 mm
345 mm
347 mm
400 mm
438 mm
500 mm
540 mm
560 mm
780 mm



1 TAH111M-6
1 TAH111M-7
1 TAH111M-8
1 TAH111M-9
1 TAH111M-10
1 TAH111M-11
1 TAH111M-12
1 TAH111M-13
1 TAH111M-14
1 TAH111M-15
1 TAH111M-16
1 TAH111M-17
1 TAH111M-18
1 TAH111M-19
1 TAH111M-20
1 TAH111M-21
1 TAH111M-22
1 TAH111M-23
1 TAH111M-24
1 TAH111M-25
1 TAH111M-27
1 TAH111M-30
1 TAH111M-32
1 TAH111M-34
1 TAH111M-36
1 TAH111M-41
1 TAH111M-46
1 TAH111M-50
1 TAH111M-55
1 TAH111M-85

Skiftnyckel ur 80-serien med snabbblänk



TAH80



110mm/4"
155mm/6"
205mm/8"
255mm/10"
305mm/12"
380mm/15"
460mm/18"
110mm/4"
155mm/6"
205mm/8"
255mm/10"
305mm/12"
380mm/15"
460mm/18"



13 mm
20 mm
27 mm
31 mm
34 mm
44 mm
53 mm
13 mm
20 mm
27 mm
31 mm
34 mm
44 mm
53 mm



1 TAH8069
1 TAH8070
1 TAH8071
1 TAH8072
1 TAH8073
1 TAH8074
1 TAH8075
1 TAH8069C
1 TAH8070C
1 TAH8071C
1 TAH8072C
1 TAH8073C
1 TAH8074C
1 TAH8075C



U-ringnyckel i tum-dimensioner, med säkerhetsfjäder



TAH111Z

Size	L	Qty	Part No.
1/4 in	112 mm	1	TAH111Z-1/4
5/16 in	130 mm	1	TAH111Z-5/16
3/8 in	140 mm	1	TAH111Z-3/8
7/16 in	153 mm	1	TAH111Z-7/16
1/2 in	169 mm	1	TAH111Z-1/2
9/16 in	177 mm	1	TAH111Z-9/16
5/8 in	195 mm	1	TAH111Z-5/8
11/16 in	200 mm	1	TAH111Z-11/16
3/4 in	218 mm	1	TAH111Z-3/4
13/16 in	250 mm	1	TAH111Z-13/16
7/8 in	250 mm	1	TAH111Z-7/8
15/16 in	270 mm	1	TAH111Z-15/16
1 in	290 mm	1	TAH111Z-1
1-1/16 in	310 mm	1	TAH111Z-1.1/16
1-1/8 in	310 mm	1	TAH111Z-1.1/8
1-1/4 in	350 mm	1	TAH111Z-1.1/4
1-5/16 in	350 mm	1	TAH111Z-1.5/16
1 3/8 in	410 mm	1	TAH111Z-1.3/8
1 7/16 in	410 mm	1	TAH111Z-1.7/16
1 1/2 in	410 mm	1	TAH111Z-1.1/2
1 5/8 in	460 mm	1	TAH111Z-1.5/8
1 11/16 in	460 mm	1	TAH111Z-1.11/16
1 3/4 in	500 mm	1	TAH111Z-1.3/4
1 13/16 in	500 mm	1	TAH111Z-1.13/16
1 7/8 in	540 mm	1	TAH111Z-1.7/8
2 in	540 mm	1	TAH111Z-2
2 1/8 in	560 mm	1	TAH111Z-2.1/8
2 1/4 in	600 mm	1	TAH111Z-2.1/4
2 3/8 in	600 mm	1	TAH111Z-2.3/8
2 1/2 in	680 mm	1	TAH111Z-2.1/2
2 5/8 in	680 mm	1	TAH111Z-2.5/8
2 3/4 in	680 mm	1	TAH111Z-2.3/4
2 7/8 in	730 mm	1	TAH111Z-2.7/8
3 in	730 mm	1	TAH111Z-3

Spärrkombinyckel med säkerhetsfjäder



TAH1RM

Size	L	Qty	Part No.
6 mm	128 mm	1	TAH1RM-6
7 mm	140 mm	1	TAH1RM-7
8 mm	140 mm	1	TAH1RM-8
9 mm	150 mm	1	TAH1RM-9

Size	L	Qty	Part No.
10 mm	159 mm	1	TAH1RM-10
11 mm	165 mm	1	TAH1RM-11
12 mm	172 mm	1	TAH1RM-12
13 in	178 mm	1	TAH1RM-13
14 in	191 mm	1	TAH1RM-14
15 in	200 mm	1	TAH1RM-15
16 in	208 mm	1	TAH1RM-16
17 mm	226 mm	1	TAH1RM-17
18 in	237 mm	1	TAH1RM-18
19 mm	248 mm	1	TAH1RM-19
21 in	290 mm	1	TAH1RM-21
22 in	361 mm	1	TAH1RM-22
24 mm	323 mm	1	TAH1RM-24
27 in	359 mm	1	TAH1RM-27
30 mm	400 mm	1	TAH1RM-30
32 in	425 mm	1	TAH1RM-32

Metrisk bockade dubbla ringnycklar, förkromade med glidfjäder i rostfritt stål



TAH2M

Size	L	Qty	Part No.
6x7 mm	165 mm	1	TAH2M-6-7
8x9 mm	180 mm	1	TAH2M-8-9
10x11 mm	190 mm	1	TAH2M-10-11
12x13 mm	210 mm	1	TAH2M-12-13
14x15 mm	226 mm	1	TAH2M-14-15
16x17 mm	246 mm	1	TAH2M-16-17
18x19 mm	266 mm	1	TAH2M-18-19

Dubbel u-nyckel med säkerhetsfjäder



TAH6M

Size	L	Qty	Part No.
6x7 mm	122 mm	1	TAH6M-6-7
8x9 mm	135 mm	1	TAH6M-8-9
10x11 mm	153 mm	1	TAH6M-10-11
12x13 mm	164 mm	1	TAH6M-12-13

Size	L	Qty	Part No.
14x15 mm	183 mm	1	TAH6M-14-15
16x17 mm	201 mm	1	TAH6M-16-17
17x19 mm	222 mm	1	TAH6M-17-19
18x19 mm	222 mm	1	TAH6M-18-19
20x22 mm	225 mm	1	TAH6M-20-22
24x27 mm	260 mm	1	TAH6M-24-27
30x32 mm	300 mm	1	TAH6M-30-32

Dubbel öppen ringnyckel med säkerhetsfjäder



TAH1949M

Size	L	Qty	Part No.
8x9 mm	140 mm	1	TAH1949M-8-9
10x11 mm	150 mm	1	TAH1949M-10-11
12x14 mm	170 mm	1	TAH1949M-12-14
14x17 mm	200 mm	1	TAH1949M-14-17
19x22 mm	220 mm	1	TAH1949M-19-22
24x27 mm	255 mm	1	TAH1949M-24-27

Slagringnyckel med D-ring



TAH7444SG

Size	L	Qty	Part No.
36 mm	205 mm	1	TAH7444SG-M-36
41 mm	230 mm	1	TAH7444SG-M-41
46 mm	240 mm	1	TAH7444SG-M-46
50 mm	255 mm	1	TAH7444SG-M-50
55 mm	270 mm	1	TAH7444SG-M-55

Metrisk, bockad, dubbelsidig hylsnyckel med 6-kants Dynamic-Drive™-profil och ring i rostfritt stål



TAH29

Ø		
12 mm	1	TAH29M-12
6 mm	1	TAH29M-6
7 mm	1	TAH29M-7
8 mm	1	TAH29M-8
10 mm	1	TAH29M-10
9 mm	1	TAH29M-9
11 mm	1	TAH29M-11
13 mm	1	TAH29M-13
14 mm	1	TAH29M-14
15 mm	1	TAH29M-15
16 mm	1	TAH29M-16
17 mm	1	TAH29M-17
18 mm	1	TAH29M-18
19 mm	1	TAH29M-19
20 mm	1	TAH29M-20
21 mm	1	TAH29M-21
22 mm	1	TAH29M-22
23 mm	1	TAH29M-23
24 mm	1	TAH29M-24
25 mm	1	TAH29M-25
26 mm	1	TAH29M-26
27 mm	1	TAH29M-27
28 mm	1	TAH29M-28
29 mm	1	TAH29M-29
30 mm	1	TAH29M-30
32 mm	1	TAH29M-32

Universalavstängarnyckel med Dyneema textilsnodd för fäste av säkerhetslina vid arbete på hög höjd



TAHMK5

L		
97x25 mm	1	TAHMK5

Spärrhandtag med säkerhetsring och fäste för säkerhetslina



TAHSC2RM

Ø	L		
13-17 mm	280 mm	1	TAHSC2RM-13-17
15-17 mm	280 mm	1	TAHSC2RM-15-17
19-22 mm	310 mm	1	TAHSC2RM-19-22
27-30 mm	450 mm	1	TAHSC2RM-27-30

RÖRTÄNGER

ERGO™ rörtång med vajerögla



ergo



TAH1410-TAH1420

L	max		
320 mm	1 in	1	TAH1410
430 mm	1 1/2 in	1	TAH1420

Rörtång, 90°, med bygelfäste



TAH14

L	max		
210 mm	3/4 in	1	TAH140
320 mm	1 in	1	TAH141
426 mm	1 1/2 in	1	TAH142
557 mm	2-1/2 in	1	TAH143

Rörtång av aluminium med snabbblänk



TAH380

L	max		
253 mm	1.1/2 in	1	TAH380-10
354 mm	2 in	1	TAH380-14
455 mm	2.1/2 in	1	TAH380-18
607 mm	3 in	1	TAH380-24

HYLSOR OCH SPÄRRHANDTAG

1/4" hylsa med fyrkantfäste, sexkantprofil och 4 fästpunkter



TAH08

Ø		
5.5 mm	1	TAH08-5.5
6 mm	1	TAH08-6
7 mm	1	TAH08-7
8 mm	1	TAH08-8
9 mm	1	TAH08-9
10 mm	1	TAH08-10
11 mm	1	TAH08-11
12 mm	1	TAH08-12
13 mm	1	TAH08-13

1/4" ledhandtag med fyrkantfäste och säkerhetsfjäder



TAH6958B-1

L		
150 mm	1	TAH6958B-1



1/4" förlängare med fyrkantfäste och 4 hål



TAHA6960-TAHA6962L



50 mm	1	TAHA6960
101 mm	1	TAHA6961
152 mm	1	TAHA6962
355 mm	1	TAHA6962L

1/4" universalknut med fyrkantfäste och 4 hål



TAHA6966



36 mm	1	TAHA6966
-------	---	----------

1/4" bitshylsa för insexskruv med fyrkantfäste och 4 fästpunkter



TAHA08-H



3 mm	1	TAHA08-H3
4 mm	1	TAHA08-H4
5 mm	1	TAHA08-H5
6 mm	1	TAHA08-H6
8 mm	1	TAHA08-H8

1/4" bitshylsa för Phillips-skruv med fyrkantfäste och 4 fästpunkter



TAHA08-PH



1	1	TAHA08-PH1
2	1	TAHA08-PH2
3	1	TAHA08-PH3

1/4" bitshylsa för Torx®-skruv med fyrkantfäste och 4 fästpunkter



TAHA08TTAH



T-8	1	TAHA08-T8
T-9	1	TAHA08-T9
T-10	1	TAHA08-T10
T-15	1	TAHA08-T15
T-20	1	TAHA08-T20
T-25	1	TAHA08-T25
T-27	1	TAHA08-T27
T-30	1	TAHA08-T30
T-40	1	TAHA08-T40

1/4" spärrhandtag med fyrkantfäste och Dyneema-ögla



TAHA6950



120 mm	1	TAHA6950
--------	---	----------

1/4" vridhandtag med fyrkantfäste och säkerhetsfäste



TAHA6956-1

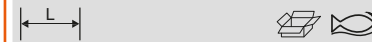

150 mm	1	TAHA6956-1
--------	---	------------

1/2" hylsa med fyrkantfäste och 4 fästpunkter och tolvkantprofil i metrisk dimensioner



TAHA16B



8 mm	1	TAHA16B-8
10 mm	1	TAHA16B-10
11 mm	1	TAHA16B-11
12 mm	1	TAHA16B-12
13 mm	1	TAHA16B-13
14 mm	1	TAHA16B-14
15 mm	1	TAHA16B-15
16 mm	1	TAHA16B-16
17 mm	1	TAHA16B-17
18 mm	1	TAHA16B-18
19 mm	1	TAHA16B-19
21 mm	1	TAHA16B-21
22 mm	1	TAHA16B-22
24 mm	1	TAHA16B-24
25 mm	1	TAHA16B-25
27 mm	1	TAHA16B-27
30 mm	1	TAHA16B-30
32 mm	1	TAHA16B-32

1/2" hylsa med fyrkantfäste, sexkantprofil och 4 fästpunkter (tumdimensioner)



TAHA16B"

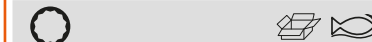

1/2 in	1	TAHA16B-1/2
9/16 in	1	TAHA16B-9/16



5/8 in	1	TAH16B-5/8
11/16 in	1	TAH16B-11/16
3/4 in	1	TAH16B-3/4
13/16 in	1	TAH16B-13/16
7/8 in	1	TAH16B-7/8
15/16 in	1	TAH16B-15/16
1 in	1	TAH16B-1
1 1/16 in	1	TAH16B-1.1/16
1 1/8 in	1	TAH16B-1.1/8
1 1/4 in	1	TAH16B-1.1/4

1/2" universalknut med 4 fästpunkter



TAH8166



67 mm



1 TAH8166

1/2" ledhandtag med säkerhetsfjäder



TAH8158B-1



256 mm



1 TAH8158B-1

1/2" bitshylsa med fyrkantsfäste och 4 fästpunkter, i metrisk dimensioner för insexskruv



TAH16H



4 mm	1	TAH16-H4
5 mm	1	TAH16-H5
6 mm	1	TAH16-H6
7 mm	1	TAH16-H7
8 mm	1	TAH16-H8
10 mm	1	TAH16-H10
12 mm	1	TAH16-H12
14 mm	1	TAH16-H14
17 mm	1	TAH16-H17
19 mm	1	TAH16-H19

Förlängare 1/2" med 4 hål



TAH8160-8162



125 mm
250 mm



1 TAH8160
1 TAH8162

1/2" bitshylsa med fyrkantsfäste och 4 fästpunkter, i tum-dimensioner för insexskruv



TAH16H'



1/4 in	1	TAH16H-1/4
5/16 in	1	TAH16H-5/16
3/8 in	1	TAH16H-3/8



7/16 in	1	TAH16H-7/16
1/2 in	1	TAH16H-1/2
9/16 in	1	TAH16H-9/16
5/8 in	1	TAH16H-5/8

1/2" bitshylsa med fyrkantsfäste och 4 fästpunkter, för Torx®-skruv



TAH16-T



T30	1	TAH16-T30
T40	1	TAH16-T40
T45	1	TAH16-T45
T50	1	TAH16-T50
T55	1	TAH16-T55
T60	1	TAH16-T60

1/2" spärrhandtag med Dyneema textilsnodd för fäste av säkerhetslina



TAH8150-1/2



270 mm



1 TAH8150-1/2



Hylsnyckelsats 1/2" med sexkantsprofil och spärrhandtag med päronformat huvud – 22 delar för för arbete på hög höjd



TAH16BM/22



85 x 350 x 445 mm



1 TAH16BM/22

Hylsnyckelsats 1/2" med fyrkantfäste och spärrhandtag med päronformat huvud – 17 delar för arbete på hög höjd



TAH16BZ/17



80 x 300 x 380 mm



1 TAH16BZ/17

3/4" hylsa med fyrkantfäste, sexkantsprofil och 4 fästpunkter



TAH24B



27 mm	1 TAH24B-27
30 mm	1 TAH24B-30
32 mm	1 TAH24B-32
36 mm	1 TAH24B-36
38 mm	1 TAH24B-38
41 mm	1 TAH24B-41
46 mm	1 TAH24B-46
50 mm	1 TAH24B-50

3/4" förlängare med fyrkantfäste och 4 fästpunkter



TAH8961



200 mm



1 TAH8961

Universalhandtag 3/4" med fyrkantfäste och fäste för säkerhetslina



TAH8953



500 mm



1 TAH8953

Spärrhuvud 3/4" med fyrkantfäste och fäste för säkerhetslina



TAH8950N/A



170 mm



1 TAH8950N/A

Verktyg för lossning av TAH-hylsa på spärrhandtagets säkerhetsstift, kort modell



ergo



TAHPINRELEASER



4 mm



45 mm



1 TAHPINRELEASER

SKRUVMEJSLAR

ERGO™ skruvmejslar för spårskruv med säkerhetsfäste



ergo



TAHBE8020L-TAHBE8252



3.2 mm

75 mm

1 TAHBE-8020L

3.5 mm

75 mm

1 TAHBE-8030

4 mm

100 mm

1 TAHBE-8040

5.5 mm

150 mm

1 TAHBE-8241

6.5 mm

150 mm

1 TAHBE-8252

ERGO™ skruvmejslar för spårskruv med Dyneema textilsnodd för fäste av säkerhetslina



ergo



TAHBE8155



6 mm

125 mm

1 TAHBE-8155

8 mm

175 mm

1 TAHBE-8257

8 mm

210 mm

1 TAHBE-8258

ERGO™ spårskruvmejsel med sexkantsgrepp med Dyneema textilsnodd för fäste av säkerhetslina



ergo®



TAHBE-8260



9 mm	175 mm	1	TAHBE-8260
12 mm	200 mm	1	TAHBE-8880

ERGO™ skruvmejsel för Phillips-skruv, med sexkantsgrepp och Dyneema textilsnodd för fäste av säkerhetslina



ergo®



TAHBE-8630



PH 3	155 mm	1	TAHBE-8630

ERGO™ skruvmejsel för Pozidriv-skruv, med sexkantsgrepp och Dyneema textilsnodd för fäste av säkerhetslina



ergo®



TAHBE-8830



PZ 3	150 mm	1	TAHBE-8830

ERGO™ spårskruvmejsel med säkerhetsfäste, kort modell



ergo®



TAHBE-8350



5.5 mm	28 mm	1	TAHBE-8350

ERGO™ skruvmejsel för Phillips-skruv med säkerhetsfäste, kort modell



ergo®



TAHBE-8602



PH2	30 mm	1	TAHBE-8602

ERGO™ skruvmejsel för Torx®-skruv med säkerhetsfäste



ergo®



TAHBE8910-TAHBE8930



T10	2.72 mm	1	TAHBE-8910
T15	3.26 mm	1	TAHBE-8915
T20	3.84 mm	1	TAHBE-8920
T25	4 mm	1	TAHBE-8925
T30	6 mm	1	TAHBE-8930

ERGO™ skruvmejsel med säkerhetsfäste, för Phillips-skruv



ergo®



TAHBE8610-TAHBE8624



PH 1	75 mm	1	TAHBE-8611
PH 1	75 mm	1	TAHBE-8610
PH 2	100 mm	1	TAHBE-8620
PH 2	200 mm	1	TAHBE-8620L
PH 3	150 mm	1	TAHBE-8623
PH 4	190 mm	1	TAHBE-8624

ERGO™ skruvmejsel för Pozidriv-skruv med säkerhetsfäste



ergo®



TAHBE8810-TAHBE8820



PZ 1	73 mm	1	TAHBE-8810
PZ 2	100 mm	1	TAHBE-8820

ERGO™ isolerade skruvmejslar för spårskruv med fästögla i Kevlar



ergo®



TAHBE8040S-TAHBE8050S



3.0 mm	100 mm	1	TAHBE-8220S
4.0 mm	100 mm	1	TAHBE-8040S
5.5 mm	125 mm	1	TAHBE-8050S
6.5 mm	155 mm	1	TAHBE-8255S



ERGO™ isolerade skruvmejslar för Phillips-skruv med fästögla i Kevlar



ergo™



TAHBE8610S-TAHBE8620S

Skruvtyp	Längd	Antal	Modell
PH1	80 mm	1	TAHBE-8610S
PH2	100 mm	1	TAHBE-8620S
PH3	150 mm	1	TAHBE-8630S
PH4	190 mm	1	TAHBE-8640S

Spårskruvmejslar med precisionsgrepp, 0,18–0,8 mm med ring i rostfritt stål



TAH700

Skruvtyp	Längd	Antal	Modell
1.5 mm	137 mm	1	TAH700-1.5-50
1.8 mm	137 mm	1	TAH700-1.8-50
2.5 mm	137 mm	1	TAH700-2.5-50
3 mm	187 mm	1	TAH700-3-100

Metrisk insexnycklar, svartoxiderad yta med ring i rostfritt stål



TAH1995M

Skruvtyp	Antal	Modell
8 mm	1	TAH1995M-8
10 mm	1	TAH1995M-10
12 mm	1	TAH1995M-12

ERGO™ isolerade skruvmejslar för Torx®-skruv med fästögla i Kevlar



ergo™



TAHBE8910S-TAHBE8930S

Skruvtyp	Längd	Antal	Modell
T10	2.5 mm	1	TAHBE-8910S
T15	3.26 mm	1	TAHBE-8915S
T20	3.84 mm	1	TAHBE-8920S
T25	4.4 mm	1	TAHBE-8925S
T30	5.49 mm	1	TAHBE-8930S

Skruvmejslar för Phillips®-skruv med precisionsgrepp, PH00–PH1 med ring i rostfritt stål



TAH701

Skruvtyp	Längd	Antal	Modell
PH00	137 mm	1	TAH701-00-50
PH 0	137 mm	1	TAH701-0-50

Insexnycklar i tumskala, svartoxiderad yta med ring i rostfritt stål



TAH1995Z

Skruvtyp	Antal	Modell
1/2 in	1	TAH1995Z-1/2

ERGO™ VDE-isolerade smala skruvmejslar för Pozidriv-skruv, med trekomponentshandtag med kevlarsträng



ergo™



TAHBE-8820SL

Skruvtyp	Antal	Modell
PZ 2	1	TAHBE-8820SL

Torx®-skruvmejslar med precisionsgrepp, T4–T20 med ring i rostfritt stål



TAH703

Skruvtyp	Längd	Antal	Modell
T 6	137 mm	1	TAH703-6-50
T 7	137 mm	1	TAH703-7-50
T 8	137 mm	1	TAH703-8-50
T 9	137 mm	1	TAH703-9-50
T 10	137 mm	1	TAH703-10-50
T 15	162 mm	1	TAH703-15-75

Hopfällbar insexnyckelsats, metrisk, med svartoxiderad yta 1,5–6 mm – 7 delar med Kevlar-ögla



TAHBE-9776

Skruvtyp	Antal	Modell
1.5, 2, 2.5, 3, 4, 5, 6 mm	1	TAHBE-9776

1.5, 2, 2.5, 3, 4, 5, 6 mm

Insexnyckelsats med säkerhetslina i Kevlar, 7 delar



TAHE-9777B



2,5,3,4,5,6,8,10 mm



1 TAHE-9777B



Dubbel vinkelskruvmejsel för Phillips-skruv, med vajerögla



TAH2047PR



PH 1 & 2



1 TAH2047PR-1-2



ERGO™ kombinationstång med säkerhetsfäste



ergo™



TAH2628G



170 mm
190 mm
200 mm



1 TAH2628G-160
1 TAH2628G-180
1 TAH2628G-200



Insexnyckelsats i tum-dimensioner med säkerhetsfäste, 7 delar



TAHE-9787



3/32, 1/8, 5/32, 3/16, 1/4, 5/16, 3/8 in



1 TAHE-9787



ERGO™ sidavbitare med säkerhetsfäste



ergo™



TAH2101G



130 mm
145 mm
165 mm
185 mm
125 mm
145 mm
165 mm
180 mm



1 TAH2101G-125
1 TAH2101G-140
1 TAH2101G-160
1 TAH2101G-180
1 TAH2101G-125C
1 TAH2101G-140C
1 TAH2101G-160C
1 TAH2101G-180C



Tång med två lägen och säkerhetsfäste



TAH2970G



200 mm



1 TAH2970G-200



Dubbel vinkelskruvmejsel för spårskruv, med vajerögla



TAH2047



4.0 mm



1 TAH2047-0.8-4



ERGO™ kraftsidavbitare med säkerhetsfäste



ergo™



TAH21HDG



210 mm
200 mm



1 TAH21HDG-200
1 TAH21HDG-200C



ERGO™ spetstång med säkerhetsfäste



ergo™



TAH2430G



160 mm
200 mm



1 TAH2430G-160
1 TAH2430G-200



ERGO™ spetstång med 45° bockade käftar och säkerhetsfäste



ergo



TAH2427G



200 mm



1 TAH2427G-200

Spärringstång för invändiga spärringar, rak käft och svartoxiderad yta med ring i rostfritt stål



TAH2800



150 mm
180 mm



1 TAH2800-150
1 TAH2800-180

Griptång med rundade käftar och fast metallplatta



TAH2953



140 mm
300 mm



1 TAH2953-140
1 TAH2953-300

ERGO™ avisoleringstång med säkerhetsfäste



ergo



TAH2223G-150



167 mm



1 TAH2223G-150

Spärringstång för utvändiga spärringar, rak käft och svartoxiderad yta med ring i rostfritt stål



TAH2900



180 mm



1 TAH2900-180

Griptång med raka käftar



TAH2958



200 mm
245 mm



1 TAH2958-200
1 TAH2958-250

Crimptång med spärrfunktion för isolerade skarvar med fast ögla för metalltråd



TAHCRW01



225 mm



0.5-6.0 mm²



1 TAHCRW01

TAH universalgriptång med rundade käftar



TAH2951



235 mm



1 TAH2951-250

ERGO™ polygriptång med säkerhetsring



ergo



TAH8224



250 mm



1 TAH8224

Trådlåstång med säkerhetsfäste



TAH2855



232 mm 1 TAH2855

Traditionell bågfil med vajerögla



TAH320

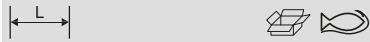

500 mm 1 TAH320

ERGO™ ansatsfil med säkerhetsfäste



ergo™



TAH1-100



265 mm 2 1 TAH1-100-06-2-4

SKÄRANDE OCH SÅGANDE VERKTYG

Hopfällbar grensåg med tvåkomponentshandtag och Dyneema-ögla



TAH396



190 mm 7 1/2 in 1 TAH396-JT

Bågfil med vajerögla, för universalbruk



TAH317

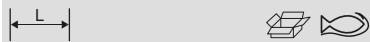

432 mm 1 TAH317

ERGO™ avsmalnande flat fil grov/medium/fin med permanent ring i rostfritt stål



ergo™



TAH1-110



200 mm 1 1 TAH1-110-08-1-2

ERGO™ professionell bågfil med vajerögla



ergo™



TAH325

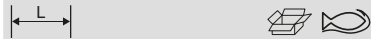

300 mm 1 TAH325

Bågfil med aluminiumhandtag och vajerögla



TAH225



310 mm 1 TAH225-PLUS

ERGO™ skärpfil med två flata ytor och säkerhetsfäste



ergo™



TAH1-143



415 mm 1 1 TAH1-143-12-1-2



ERGO™ fyrkantsfil grov/medium/fin med permanent ring i rostfritt stål



ergo



TAH1-160



200 mm	1	1	TAH1-160-08-1-2

ERGO™ trekantsfil grov/medium/fin med permanent ring i rostfritt stål



ergo



TAH1-170



200 mm	1	1	TAH1-170-08-1-2

ERGO™ halvrund fil med säkerhetsfäste



ergo



TAH1-210



270 mm	2	1	TAH1-210-06-2-2
325 mm	1	1	TAH1-210-08-1-2

ERGO™ rund fil med säkerhetsfäste



ergo



TAH1-230



260 mm	2	1	TAH1-230-06-2-2
310 mm	1	1	TAH1-230-08-1-2

Extra kraftiga elektrikersaxar med fäste för säkerhetslina



TAHSCB140G



145 mm	43 mm	1	TAHSCB140G

Kabelkniv med Dyneema-ögla



TAH2820EF



195 mm	85 mm	1	TAH2820EF2

Universalkniv med skjutbart blad och Dyneema-ögla



TAH8687



172 mm		1	TAH868700000

Stålbörste med trähandtag



TAH52-TAH782-U



150 mm		1	TAH52
290 mm		1	TAH782-U

HAMMARE, BRÄCKJÄRN OCH STÄMJÄRN

Studsfri slägga med slintfritt handtag och vajerögla



TAH3625PU



620 g	340 mm	1	TAH3625PU-50

Hammare med slagytta av nylon och vajerögla



TAH3625PW



300 mm		1	TAH3625W-35	

Mejselhammare med hickoryskaft och vajerögla



TAH484



1000 g	260 mm	1	TAH484-1000	
1500 g	280 mm	1	TAH484-1500	
2000 g	305 mm	1	TAH484-2000	

Murarhammare av spansk typ med vajerögla



TAH486F



700 g	330 mm	1	TAH486F-700	

Kulhammare med hickoryskaft och vajerögla



TAH479



480 g	350 mm	1	TAH479-16	
900 g	400 mm	1	TAH479-32	

Säkerhetsslagga med vajerögla



TAH489



1100 g	294 mm	1	TAH489-1100	
1800 g	300 mm	1	TAH489-1800	
2700 g	770 mm	1	TAH489-2700	
3600 g	770 mm	1	TAH489-3600	
4500 g	797 mm	1	TAH489-4500	
5400 g	795 mm	1	TAH489-5400	
6300 g	780 mm	1	TAH489-6300	

Snickarhammare med pik och stålörsskaft med vajerögla



TAH485



600 g		1	TAH485	

Plåtslagarhammare med vajerögla



TAH481



300 g	300 mm	1	TAH481-300	

Kul- och penhammare med okrossbart handtag och fast metallvajerögla



TAH490



700 g	340 mm	1	TAH490-700	
900 g	340 mm	1	TAH490-900	
1100 g	340 mm	1	TAH490-1100	

Gnistfri och omagnetisk hammare med fäste i aluminium-brons



TAH487



4500 g	895 mm	1	TAH487-5200	



TAH kofot i specialstål



TAHWBB



595 mm 1 TAHWBB600
680 mm 1 TAHWBB700

Huggmejsel med säkerhetsfäste



TAH3640



250 mm 1 TAH3640-250-C

Bräckjärn med bygelfäste



TAH3683



400 mm 1 TAH3683

Dom med tvåkomponentshandtag och säkerhetsfäste



TAH3734BM



155 mm	2 mm	1 TAH3734BM-2
155 mm	3 mm	1 TAH3734BM-3
165 mm	4 mm	1 TAH3734BM-4
165 mm	5 mm	1 TAH3734BM-5
185 mm	6 mm	1 TAH3734BM-6
185 mm	8 mm	1 TAH3734BM-8
185 mm	10 mm	1 TAH3734BM-10

Kryssmejsel med åttkantig kropp och kopparfärgad lackerad yta med fast metallvajerögla



TAH3739



300 mm 1 TAH3739-300

Bräckjärn med rundat huvud och svartoxiderat skaft med fast metallvajerögla



TAH3681



304 mm 1 TAH3681-11
406 mm 1 TAH3681-16
503 mm 1 TAH3681-20

Körnare med tvåkomponentshandtag och säkerhetsfäste



TAH3755BM



165 mm 4 mm 1 TAH3755BM-4

Bräckjärn med PVC-handtag och säkerhetsfäste



TAH2484



305 mm 1 TAH2484-30

MÄTNING OCH MÄRKNING

Långa måttband med nylonöverdraget band och öppen hållare med Dyneema-ögla



TAHLTS



30 m 13 mm 1 TAHLTS-30

Metrisk linjal i rostfritt stål med Dyneema-ögla



TAHSR300



300 mm



1 TAHSR300-MM



Vinkelhake med Dyneema textilsnodd för fäste av säkerhetslina



TAH9048-250



250 mm



165 mm



1 TAH9048-250



Bladmått med säkerhetsfäste för proffsbruk



TAH1544



105 mm



1 TAH1544



Vattenpass med Dyneema-ögla



TAH9045-B-250



250 mm



170 mm



1 TAH9045-B-250



Vinkelhakar med Dyneema textilsnodd för fäste av säkerhetslina



TAH1150



250 mm



170 mm



1 TAH1150-1/2H/P



TAH466



250 mm



1 TAH466-250



Skjutmått med säkerhetsfäste



TAH1150



7 x 75 x 235 mm



1 TAH1150-1/2H/P

TAH73R



Nm



1/2"	20-100 Nm	1	TAH73R-100
1/2"	40-200 Nm	1	TAH73R-200
1/2"	60-300 Nm	1	TAH73R-300



Kombinationsvinkelhake med Dyneema textilsnodd för fäste av säkerhetslina



TAHCS300



300 mm



125 mm



1 TAHCS300



Vinklad rits med vajerögla



TAH1177



30 g



1 TAH1177-SCRIBE



Momentnyckel med fast spärrhuvud och vajerögla



TAH7445



20-100 Nm



1/2 in



1 TAH7445-100A-1



Mekanisk momentnyckel med vajerögla



TAH7455

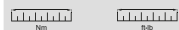

60-300 Nm 44.3-221.3 lb-ft lbf-ft



1 TAH7455-300-1

Insticksverktyg, spärrhuvud med låsmekanism med säkerhetsstift



TAH7852-1



14X18 mm 1/2" 1 TAH7852-1

Sats med små sylar, krokav och krokavverktyg med kevlarögla



TAH2633

146 g

1 TAH2633/S4

Momentnyckel med utbytbart huvud och vajerögla



TAH74W9

20-100 N·m 9x12 mm



1 TAH74W9-100

Tving med bygelfäste



TAH420SH-80-160

160 mm 80 mm 1 TAH420SH-80-160

Flexibelt gripverktyg med vajerögla



TAH2509

560 mm

1 TAH2509

Insticksverktyg spärrhuvud, med låsanordning



TAH7452-2

9x12 mm 1/2"

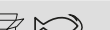

1 TAH7452-2

ÖVRIGA VERKTYG

Packningskrapa med säkerhetsfjäder



TAH2487

205 mm 1 TAH2487

ERGO™ magnetiskt gripverktyg med Dyneema-ögla



ergo



TAH2535F2

13 mm 405 mm 1 TAH2535F2

Oljefilterkedjenyckel med fäste för säkerhetslina



TAHBE64520

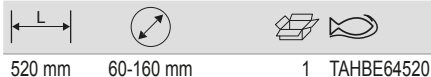

520 mm 60-160 mm 1 TAHBE64520

Pannlampa med Dyneema textilsnodd för fäste av säkerhetslina



TAHBFRL11



90 x 95 x 115 mm 1 TAHBFRL11

Fettspruta med snabbfäste



TAHBOD54



120 x 385 x 57 mm 1 TAHBOD5400
135 x 400 x 61 mm 1 TAHBOD5450

SKYDDSHANDSKAR

Allroundhandskar med stötdämpning



GL008



8 5 GL008-8
10 5 GL008-10

Handschar i konstläder och textilmaterial, för allroundbruk



3875-GLOVE

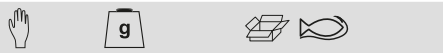

9 67 g 5 3875-GLOVE

Verktygshandskar med stöt- och vibrationsdämpning



GL010

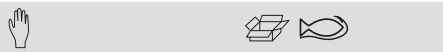

8 5 GL010-8
10 5 GL010-10



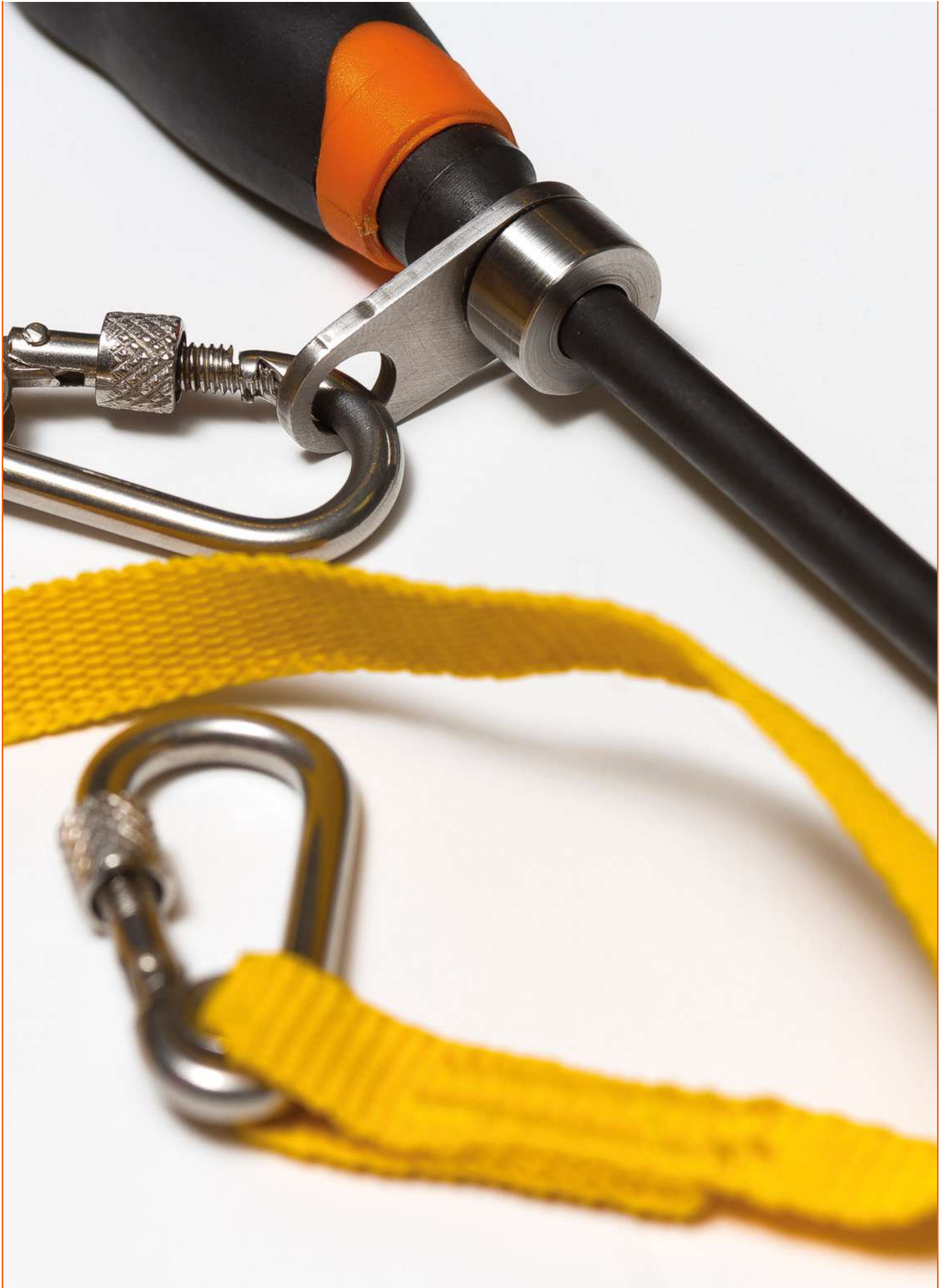

BAHCO



Isolerade verktyg



SKRUVMEJSLAR

ERGO™ VDE-isolerade skruvmejslar för spårskruv med trekomponentshandtag 0,4 mm–2 mm



ergo



BE-8010S–BE-8065S

Spårskruv	Handtag	Antal	Modell
2.5 mm	75 mm	5	BE-8010S
3.0 mm	100 mm	5	BE-8220S
3.5 mm	100 mm	5	BE-8230S
4.0 mm	100 mm	5	BE-8040S
5.5 mm	125 mm	5	BE-8050S
6.5 mm	150 mm	5	BE-8255S
8.0 mm	175 mm	5	BE-8065S
10 mm	200 mm	5	BE-8258S
12 mm	200 mm	5	BE-8259S

ERGO™ VDE-isolerade skruvmejslar med trekomponentshandtag, för Phillips®-skruv PH0–PH4



ergo



BE-8600S–BE-8640S

Skruv	Handtag	Antal	Modell
PH 0	75 mm	5	BE-8600S
PH 1	80 mm	5	BE-8610S
PH1	80 mm	5	BE-8611S
PH 1	150 mm	5	BE-8612S
PH 2	100 mm	5	BE-8620S
PH 2	100 mm	5	BE-8621S
PH 2	175 mm	5	BE-8622S
PH 3	150 mm	5	BE-8630S
PH 4	200 mm	5	BE-8640S

ERGO™ VDE-isolerade skruvmejslar med trekomponentshandtag, för Pozidriv-skruv PZ0–PZ4



ergo



BE-8800S–BE-8840S

Skruv	Handtag	Antal	Modell
PZ 0	75 mm	5	BE-8800S
PZ 1	80 mm	5	BE-8810S
PZ1	80 mm	5	BE-8811S
PZ 1	150 mm	5	BE-8812S
PZ 2	100 mm	5	BE-8820S
PZ 2	100 mm	5	BE-8821S
PZ 2	175 mm	5	BE-8822S
PZ 3	150 mm	5	BE-8830S
PZ 4	200 mm	5	BE-8840S

ERGO™ VDE-isolerade Torx®-skruvmejslar med trekomponentshandtag, T5–T30



ergo



BE-8910S–BE-8930S

Skruv	Handtag	Antal	Modell
T 5	75 mm	5	BE-8905S
T 6	75 mm	5	BE-8906S
T 7	75 mm	5	BE-8907S
T 8	75 mm	5	BE-8908S
T 9	75 mm	5	BE-8909S
T 10	100 mm	5	BE-8910S
T 15	125 mm	5	BE-8915S
T 20	125 mm	5	BE-8920S
T 25	150 mm	5	BE-8925S
T 30	175 mm	5	BE-8930S

ERGO™ VDE-isolerade insexskruvmejslar med trekomponentshandtag, 2,5 mm–8 mm



ergo



BE-8725S–BE-8708S

Skruv	Handtag	Antal	Modell
2.5 mm	100 mm	5	BE-8725S
3 mm	125 mm	5	BE-8703S
4 mm	150 mm	5	BE-8704S
5 mm	175 mm	5	BE-8705S
6 mm	150 mm	5	BE-8706S
8 mm	200 mm	5	BE-8708S

ERGO™ VDE-isolerade kombiskruvmejslar med trekomponentshandtag, för spårskruv och Pozidriv-skruv, 5 mm, 6 mm, PH1, PH2



ergo



BE-8510S–BE-8520S

Skruv	Handtag	Antal	Modell
5.0/PH1	80 mm	5	BE-8510S
6.0/PH2	100 mm	5	BE-8520S

ERGO™ VDE-isolerade kombiskruvmejslar med trekomponentshandtag, för spårskruv och Pozidriv-skruv 5 mm, 6 mm, PZ1, PZ2



ergo



BE-8710S–BE-8720S

Skruv	Handtag	Antal	Modell
5.0/PZ1	80 mm	5	BE-8710S
6.0/PZ2	100 mm	5	BE-8720S

ERGO™ VDE-isolerade hylsskruvmejslar med trekomponentshandtag 5,5 mm -10 mm



ergo



BE-7855S–BE-7810S

Skruv	Handtag	Antal	Modell
5.5 mm	125 mm	5	BE-7855S
6 mm	125 mm	5	BE-7806S
7 mm	125 mm	5	BE-7807S
8 mm	125 mm	5	BE-7808S
9 mm	125 mm	5	BE-7809S
10 mm	125 mm	5	BE-7810S

ERGO™ sats med VDE-isolerade kombiskruvmejslar med trekomponentshandtag, för spår-/Pozidriv-skruv-2 delar



ergo



BE-9890S

X	g		
2	175 g	1	BE-9890S

BE-8710S, BE-8720S



ERGO™ Sats med VDE-isolerade skruvmejslar med trekomponentshandtag, för spårskruv och Phillips-skruv, 5 delar



ergo



BE-9881S

X			
5		1	BE-9881S

BE-8220S, BE-8040S, BE-8050S



BE-8611S, BE-8621S



ERGO™ sats med VDE-isolerade skruvmejslar med trekomponentshandtag, för spår- och Pozidriv-skruv, 5 delar



ergo



BE-9882S

X			
5		1	BE-9882S

BE-8220S, BE-8050S, BE-8040S



BE-8811S, BE-8821S



ERGO™ sats med VDE-isolerade kombiskruvmejslar för spårskruv, Phillips- och Pozidriv-skruv-5 delar



ergo



BE-9885S

X			
5		1	BE-9885S

806-1-1



BE-8520S, BE-8510S



BE-8710S, BE-8720S



ERGO™ sats med VDE-isolerade kombiskruvmejslar för spår- och Pozidriv-skruv, med flerkomponentshandtag-6 delar



ergo



BE-9884S

X			
6		1	BE-9884S

BE-8220S, BE-8040S



BE-8710S, BE-8720S



BE-8810S, BE-8820S



ERGO™ sats med VDE-isolerade skruvmejslar med trekomponentshandtag 12 mm-7 delar



ergo



BE-9888S

X			
7		1	BE-9888S

BE-8040S, BE-8050S, BE-8010S, BE-8220S



BE-8800S, BE-8821S, BE-8830S



ERGO™ sats med VDE-isolerade skruvmejslar med trekomponentshandtag, för spår- och Phillips-skruv-7 delar



ergo



BE-9887S

X			
7		1	BE-9887S

806-1-1



BE-8010S, BE-8050S, BE-8230S, BE-8040S



BE-8611S, BE-8621S



ERGO™ sats med VDE-isolerade skruvmejslar med trekomponentshandtag, för spår- och Pozidriv-skruv-7 delar



ergo



BE-9889S

X			
7		1	BE-9889S

BE-8010S, BE-8040S, BE-8050S, BE-8230S

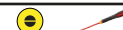

BE-8821S, BE-8811S



806-1-1



Sats med ERGO™ skruvmejslar för spår-, Phillips®, Pozidriv- och Torx®-skruv samt kombispets spår/PZ-skruv med gummigrepp – 14 st.



ergo



BE-9876S

X			
14	1	BE-9876S	

- BE-8010S, BE-8220S, BE-8230S, BE-8040S, BE-8050S
- BE-8611S, BE-8621S
- BE-8811S, BE-8821S
- BE-8910S, BE-8915S, BE-8920S
- BE-8710S, BE-8720S

ERGO™ VDE-isolerade spårskruvmejslar med trekompontshandtag och tunn klinga, 0,5 mm–1,2 mm



ergo



BE-8220SL–BE-8255SL

3.0 mm	100 mm	10	BE-8220SL
3.5 mm	100 mm	10	BE-8230SL
4.0 mm	100 mm	10	BE-8040SL
5.5 mm	125 mm	10	BE-8050SL
6.5 mm	150 mm	10	BE-8255SL

ERGO™ VDE-isolerade skruvmejslar med tunn klinga med trekompontshandtag, för Phillips-skruv PH1–PH2



ergo



BE-8610SL–BE-8620SL

PH 1	80 mm	10	BE-8610SL
PH 2	100 mm	10	BE-8620SL

ERGO™ VDE-isolerade smala skruvmejslar med trekompontshandtag, för Pozidriv-skruv, PZ1-PZ2



ergo



BE-8810SL–BE-8820SL

PZ 1	80 mm	10	BE-8810SL
PZ 2	100 mm	10	BE-8820SL

ERGO™ VDE-isolerade smala Torx®-skruvmejslar med trekompontshandtag, T5 -T30



ergo



BE-8910SL–BE-8930SL

T 10	100 mm	5	BE-8910SL
T 15	100 mm	5	BE-8915SL
T 20	100 mm	5	BE-8920SL
T 25	125 mm	5	BE-8925SL
T 30	150 mm	5	BE-8930SL

ERGO™ VDE-isolerade smala kombiskruvmejslar med trekompontshandtag för spårskruv och Phillips-skruv, 5 mm, 6 mm, PH1, PH2



ergo



BE-8510SL–BE-8520SL

5.0/PH1	80 mm	10	BE-8510SL
6.0/PH2	100 mm	10	BE-8520SL

ERGO™ VDE-isolerade kombiskruvmejslar med trekompontshandtag, för spårskruv och Pozidriv-skruv, 5 mm, 6 mm, PZ1, PZ2



ergo



BE-8710SL–BE-8720SL

5.0/PZ1	80 mm	10	BE-8710SL
6.0/PZ2	100 mm	10	BE-8720SL

ERGO™ sats med VDE-isolerade smala skruvmejslar med trekompontshandtag för elcentraler och terminaler–2 delar



ergo



BE-9890SL

X	g		
2	175 g	1	BE-9890SL

BE-8710SL, BE-8720SL

ERGO™ sats med VDE-isolerade smala Phillips-skruvmejslar med trekompontshandtag–2 delar



ergo



BE-9891SL

X	g		
2	132 g	1	BE-9891SL

BE-8610SL, BE-8620SL

ERGO™ sats med VDE-isolerade smala Pozidriv-skruvmejslar med trekomponentshandtag-2 delar



ergo



BE-9894SL

X	g		
2	132 g	1	BE-9894SL

BE-8810SL, BE-8820SL

ERGO™ sats med VDE-isolerade smala Torx®-skruvmejslar med trekomponentshandtag-4 delar



ergo



BE-9880SL

X			
4		1	BE-9880SL

BE-8910SL, BE-8915SL, BE-8920SL, BE-8925SL

ERGO™ sats med smala VDE-isolerade skruvmejslar med trekomponentshandtag, för spårskruv och Phillips-skruv, 5 delar



ergo

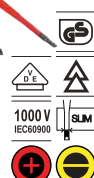

BE-9881SL

X			
5		1	BE-9881SL

BE-8220SL, BE-8040SL, BE-8050SL
BE-8610SL, BE-8620SL

ERGO™ sats med VDE-isolerade skruvmejslar med trekomponentshandtag, för spår- och Pozidriv-skruv, 5 delar



ergo



BE-9882SL

X			
5		1	BE-9882SL

BE-8220SL, BE-8040SL, BE-8050SL
BE-8810SL, BE-8820SL

ERGO™ sats med VDE-isolerade smala skruvmejslar med trekomponentshandtag för spår-, Phillips- och Torx®-skruv - 5 delar



ergo

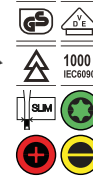

BE-9871SL

X			
5		1	BE-9871SL

BE-8220SL, BE-8040SL
BE-8910SL
BE-8610SL, BE-8620SL

ERGO™ sats med VDE-isolerade smala skruvmejslar med trekomponentshandtag för spår-, Pozidriv- och Torx®-skruv - 5 delar



ergo



BE-9872SL

X			
5		1	BE-9872SL

BE-8220SL, BE-8040SL
BE-8910SL
BE-8810SL, BE-8820SL

ERGO™ sats med VDE-isolerade smala skruvmejslar med trekomponentshandtag 12 mm-12 delar



ergo



BE-9878SL

X			
12		1	BE-9878SL

BE-8010S
BE-8220SL, BE-8230SL, BE-8040SL, BE-8050SL
BE-8610SL, BE-8620SL
BE-8810SL, BE-8820SL
BE-8510SL, BE-8520SL
BE-8910SL

BahcoFit VDE isolerade skruvmejslar för spårskruv, med flerkomponenthandtag 0,4 mm-2 mm



B196

2.5 mm	75 mm	10	B196.025.075
3 mm	100 mm	10	B196.030.100
3.5 mm	100 mm	10	B196.035.100
4 mm	100 mm	10	B196.040.100
5 mm	125 mm	10	B196.055.125
6.5 mm	150 mm	10	B196.065.150
8 mm	175 mm	10	B196.080.175
10 mm	200 mm	10	B196.100.200
12 mm	200 mm	10	B196.120.200
2.5 mm	75 mm	1	SB196.025.075
3 mm	100 mm	1	SB196.030.100
3.5 mm	100 mm	1	SB196.035.100
4 mm	100 mm	1	SB196.040.100
5.5 mm	125 mm	1	SB196.055.125
6.5 mm	150 mm	1	SB196.065.150
8 mm	175 mm	1	SB196.080.175
10 mm	200 mm	1	SB196.100.200
12 mm	200 mm	1	SB196.120.200



BahcoFit VDE-isolerade skruvmejslar för Phillips-skruv med flerkomponentshandtag PH0-PH4



B197PH

PH0	75 mm	10	B197.000.075
PH1	80 mm	10	B197.001.080
PH1	150 mm	10	B197.001.150
PH2	100 mm	10	B197.002.100
PH2	175 mm	10	B197.002.175
PH3	150 mm	10	B197.003.150
PH4	200 mm	10	B197.004.200
PH0	75 mm	1	SB197.000.075
PH1	80 mm	1	SB197.001.080
PH2	100 mm	1	SB197.002.100
PH3	150 mm	1	SB197.003.150
PH4	200 mm	1	SB197.004.200

BahcoFit VDE-isolerade skruvmejslar för Pozidriv-skruv med flerkomponentshandtag PZ0-PZ3



B142PZ

PZ0	75 mm	10	B142.000.075
PZ1	80 mm	10	B142.001.080
PZ1	150 mm	10	B142.001.150
PZ2	100 mm	10	B142.002.100
PZ2	175 mm	10	B142.002.175
PZ3	150 mm	10	B142.003.150
PZ0	75 mm	1	SB142.000.075
PZ1	80 mm	1	SB142.001.080
PZ2	100 mm	1	SB142.002.100
PZ3	150 mm	1	SB142.003.150

BahcoFit VDE-isolerade Torx®-skruvmejslar med flerkomponentshandtag T10-T25



B150TORX

T10	100 mm	10	B150.010.100
T15	125 mm	10	B150.015.125

T20	125 mm	10	B150.020.125
T25	150 mm	10	B150.025.150
T10	100 mm	1	SB150.010.100
T15	125 mm	1	SB150.015.125
T20	125 mm	1	SB150.020.125
T25	150 mm	1	SB150.025.150

BahcoFit VDE-isolerade kombinerade skruvmejslar för spår- och Phillips-skruv med flerkomponentshandtag 5 mm-6 mm och PH1-PH2



B148

5.0mm/PH1	80 mm	10	B148.001.080
6.0mm/PH2	100 mm	10	B148.002.100
5.0mm/PH1	80 mm	1	SB148.001.080
6.0mm/PH2	100 mm	1	SB148.002.100

BahcoFit VDE-isolerade hylsskruvmejslar med flerkomponentshandtag 5,5 mm -13 mm



B199

5,5 mm	125 mm	5	B199.055.125
6 mm	125 mm	5	B199.060.125
7 mm	125 mm	5	B199.070.125
8 mm	125 mm	5	B199.080.125
9 mm	125 mm	5	B199.090.125
10 mm	125 mm	5	B199.100.125
11 mm	125 mm	5	B199.110.125
12 mm	125 mm	5	B199.120.125
13 mm	125 mm	5	B199.130.125
5,5 mm	125 mm	1	SB199.055.125
6 mm	125 mm	1	SB199.060.125
7 mm	125 mm	1	SB199.070.125
8 mm	125 mm	1	SB199.080.125
9 mm	125 mm	1	SB199.090.125
10 mm	125 mm	1	SB199.100.125
11 mm	125 mm	1	SB199.110.125
12 mm	125 mm	1	SB199.120.125
13 mm	125 mm	1	SB199.130.125

BahcoFit VDE-isolerade kombiskruvmejslar för spår- och Pozidriv-skruv med flerkomponentshandtag 5 mm-6 mm och PZ1-PZ2



B149

5.0mm/PZ1	80 mm	10	B149.001.080
6.0mm/PZ2	100 mm	10	B149.002.100
5.0mm/PZ1	80 mm	1	SB149.001.080
6.0mm/PZ2	100 mm	1	SB149.002.100

BahcoFit sats med VDE-isolerade skruvmejslar med flerkomponentshandtag, för spår- och Phillips-skruv-2 delar



B220.002

2	90 g	1	B220.002

B196.030.100

B197.001.080

BahcoFit sats med VDE-isolerade kombiskruvmejslar med flerkomponentshandtag, för spår- och Pozidriv-skruv-2 delar



B220.012

2	182 g	1	B220.012

B149.001.080, B149.002.100

BahcoFit VDE sats med isolerade skruvmejslar med flerkomponentshandtag, för spår- och Phillips®-skruv-5 delar



B220.005



1 B220.005

5

B196.030.100, B196.040.100,
B196.055.125



B197.001.080, B197.002.100



BahcoFit VDE sats med isolerade skruvmejslar med flerkomponentshandtag, för spår- och Pozidriv-skruv-5 delar

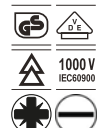

B220.015



1 B220.015

5

B196.035.100, B196.040.100,
B196.065.150



B142.001.080, B142.002.100



BahcoFit VDE sats med isolerade skruvmejslar med flerkomponentshandtag, för spår- och Phillips®-skruv-7 delar



B220.007



1 B220.007

7

B196.030.100, B196.040.100,
B196.055.125, B196.065.150



B197.000.075, B197.001.080,
B197.002.100



BahcoFit sats med VDE-isolerade skruvmejslar för spår- och Pozidriv-skruv med flerkomponentshandtag-7 delar



B220.017



1 B220.017

7

B196.025.075, B196.040.100,
B196.055.125, B196.065.150



B142.000.075, B142.001.080,
B142.002.100



BahcoFit VDE sats med isolerade skruvmejslar med flerkomponentshandtag och spanningsprovare för 150-250 V-7 delar



B220.027



1 B220.027

7

B196.030.100, B196.040.100,
B196.055.125



B197.000.075, B197.001.080,
B197.002.100



806-1-1



VDE-isolerade skruvmejslar för spårskruv, med flerkomponenthandtag 0,5 mm-1,2 mm



623

3.0 mm	100 mm	10	623-3-100
3.5 mm	100 mm	10	623-3.5-100
4.0 mm	100 mm	10	623-4-100
5.5 mm	125 mm	10	623-5.5-125
6.5 mm	150 mm	10	623-6.5-150

VDE-isolerade Phillips-skruvmejslar med flerkomponentshandtag PH0-PH2



625PH

PH 0	100 mm	10	625-0-100
PH 1	150 mm	10	625-1-150
PH 2	175 mm	10	625-2-175

Sats med skruvmejslar med tvåkomponentshandtag, för spårskruv 3, 4, 5, 5, 6, 5 mm och Phillips®-skruv PH1, PH2 - 6 st.



620-6

6	1	620-6
623-4-100, 623-3-100, 623-5.5-125, 623-6.5-150		
625-1-150, 625-2-175		



Isolerat spärrskruvmejselhandtag och utbytbara klingor för Phillips- och spärrskruv, 6 delar

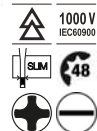

808061

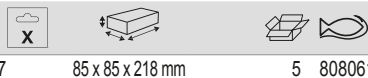

7 85 x 85 x 218 mm 5 808061

808060		
8610SL-2P, 8620SL-2P		
8010SL-2P, 8050SL-2P, 8220SL-2P, 8040SL-2P		

Isolerat spärrskruvmejselhandtag och utbytbara klingor för Pozidriv- och spärrskruv, 6 delar



808062



7 85 x 85 x 215 mm 5 808062

808060		
8820SL-2P, 8810SL-2P		
8010SL-2P, 8050SL-2P, 8220SL-2P, 8040SL-2P		

Isolerat spärrskruvmejselhandtag av tvåkomponentsmaterial



808060



36 mm 122 mm 1 808060

Isolerade utbytbara skruvmejselklingor för spärrskruv, extra smala



8010SL-2P-8050SL-2P



0.4 mm	2.5 mm	1	8010SL-2P
0.5 mm	3.0 mm	1	8220SL-2P
0.8 mm	4.0 mm	1	8040SL-2P
1.0 mm	5.5 mm	1	8050SL-2P

Isolerade smala utbytbara klingor för Phillips-skruv, PH1, PH2



8610SL-2P-8620SL-2P



1	1	8610SL-2P
2	1	8620SL-2P

Isolerade utbytbara smalsolerade utbytbara skruvmejselklingor för Pozidriv-skruv (PZ1, PZ2), extra smala



8810SL-2P-8820SL-2P



1	1	8810SL-2P
2	1	8820SL-2P

Isolerade smala skruvmejselklingor med kombispets för spår- och Phillips-skruv



8510SL-2P-8520SL-2P



5.0/PH1	1	8510SL-2P
6.0/PH2	1	8520SL-2P

Isolerade smala skruvmejselklingor med kombispets för spår- och Pozidriv-skruv



8710SL-2P-8720SL-2P

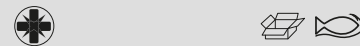

5.0/PZ1	1	8710SL-2P
6.0/PZ2	1	8720SL-2P

Isolerade smala skruvmejselklingor för Torx®-skruv



8910SL-2P-8930SL-2P



10	1	8910SL-2P
15	1	8915SL-2P
20	1	8920SL-2P
25	1	8925SL-2P
30	1	8930SL-2P

TÄNGER

ERGO™ sidavbitare med isolerade handtag och svartoxiderad yta



ergo®



2101S



Cu	Fe+		
3.7 mm	2.0 mm	3	2101S-140
3.8 mm	2.5 mm	3	2101S-160
4.0 mm	2.7 mm	3	2101S-180

ERGO™ sidavbitare med isolerade handtag och svartoxiderad yta, 200 mm



2101S-200



Cu	Fe+		
4.5 mm	3.0 mm	3	2101S-200

Isolerad kabelsax för 30 mm koppar/aluminium



2520S



L			
552 mm		1	2520 S

VDE-isolerad sidavbitare



2171V



Cu	L		
2.7 mm	160 mm	2	2171V-160
2.8 mm	180 mm	2	2171V-180
4.0 mm	200 mm	2	2171V-200

VDE-isolerad najtång



527V



Cu	L		
2 mm	160 mm	2	527V-160
2.5 mm	200 mm	2	527V-200

VDE-isolerad kabelsax



2250V



L			
170 mm	0-10 mm	2	2250V-170
230 mm	0-15 mm	2	2250V-230

Isolerad bultsax



2820VBC



L		
630 mm		1 2820VBC

Sidavbitare med isolerade handtag av cellulosaacetat och förnicklad och förkromad yta



2674 NVDE



Cu	Fe+		
3.7 mm	2.0 mm	1	2674 NVDE

ERGO™ kombinationstång med isolerade tvåkomponentshandtag och fosfaterad yta



ergo®



2628S



Fe+	Plano		
2.0 mm	1.8 mm	3	2628 S-160
2.5 mm	2.0 mm	3	2628 S-180
3.0 mm	2.5 mm	3	2628 S-200



Förstärkt kombinationstång med isolerade tvåkomponentshandtag och förkromad yta



ergo®



2630SC

180 mm	3 2630SC-180	



ERGO™ spetstång böckad i 45°, med isolerade tvåkomponentshandtag och fosfaterad yta



ergo®



2427S

3.0 mm 3.0 mm	1.8 mm 1.8 mm	3 3	2427S-160 2427 S-200



VDE-isolerad spetstång



2430V

3.0 mm 3.0 mm	160 mm 200 mm	2 2	2430V-160 2430V-200



VDE-isolerad kombinationstång



2678V

2.7 mm 3.0 mm 4.0 mm	160 mm 180 mm 200 mm	2 2 2	2678V-160 2678V-180 2678V-200



ERGO™ lång flackstång med isolerade tvåkomponentshandtag och fosfaterad yta



ergo®



2421S

140 mm 160 mm 180 mm	3 3 3	2421S-140 2421S-160 2421S-180



VDE-isolerad spetstång, böckad 45°



2427V

3.0 mm	200 mm	2	2427V-200



ERGO™ lång spetstång med isolerade tvåkomponentshandtag och fosfaterad yta



ergo®



2430S

2.5 mm 3.0 mm 3.0 mm	1.8 mm 1.8 mm 1.8 mm	3 3 3	2430S-140 2430 S-160 2430 S-200



ERGO™ rundstång med isolerade tvåkomponentshandtag och fosfaterad yta



ergo®



2521S

140 mm 160 mm	3 3	2521S-140 2521S-160



VDE-isolerad lång flackstång



2421V

160 mm	2	2421V-160



VDE-isolerad rundtång



2521V



160 mm



2 2521V-160



ERGO™ avisoleringstång med isolerade tvåkomponentshandtag och fosfaterad yta



2223S



165 mm



3 2223 S-150



VDE-isolerad avisoleringstång



2223V



160 mm



0.5-5 mm



2 2223V-160



Isolerad snabbjusterad polygrip med tvåkomponentshandtag



7224S



250 mm



4 7224S



ISO 8976, IEC 60900

DRAGVERKTYG

Isolerade skiftnycklar



8070V-8074V



165mm/6"
205mm/8"
260mm/10"
310mm/12"
390mm/15"



2 8070V
2 8071V
2 8072V
2 8073V
2 8074V



Isolerade skiftnycklar med sidoskruv



8071VLT-8073VLT



205mm/8"
255mm/10"
305mm/12"



1 8071VLT
1 8072VLT
1 8073VLT



Isolerade u-nycklar



6MV



6 mm
7 mm
8 mm
9 mm
10 mm
11 mm
12 mm
13 mm
14 mm
15 mm
16 mm
17 mm
18 mm
19 mm
20 mm
21 mm
22 mm
23 mm
24 mm
27 mm
30 mm
32 mm



5 6MV-6
5 6MV-7
5 6MV-8
5 6MV-9
5 6MV-10
5 6MV-11
5 6MV-12
5 6MV-13
5 6MV-14
5 6MV-15
5 6MV-16
3 6MV-17
3 6MV-18
3 6MV-19
3 6MV-20
3 6MV-21
3 6MV-22
3 6MV-23
3 6MV-24
2 6MV-27
2 6MV-30
2 6MV-32



Isolerade skiftnycklar med sidoskruv



8070VL-8073VL



160mm/6"
210mm/8"
260mm/10"
310mm/12"



1 8070VL
1 8071VL
1 8072VL
1 8073VL



Bockade ringnycklar med isolering



2MV



6.0 mm	5	2MV-6
7.0 mm	5	2MV-7
8.0 mm	5	2MV-8
9.0 mm	5	2MV-9
10.0 mm	5	2MV-10
11.0 mm	5	2MV-11
12.0 mm	5	2MV-12
13.0 mm	5	2MV-13
14.0 mm	5	2MV-14
15.0 mm	5	2MV-15
16.0 mm	5	2MV-16
17.0 mm	3	2MV-17
18.0 mm	3	2MV-18
19.0 mm	3	2MV-19
21.0 mm	3	2MV-21
22.0 mm	3	2MV-22
23.0 mm	3	2MV-23
24.0 mm	3	2MV-24



Isolerad hylsnyckel



2820V



7x9x11x13 mm	1	2820V13
--------------	---	---------



Isolerade hylsnycklar med T-handtag



28MV



8.0 mm	2	28MV-8
9.0 mm	2	28MV-9
10.0 mm	2	28MV-10
11.0 mm	2	28MV-11
12.0 mm	2	28MV-12
13.0 mm	2	28MV-13
14.0 mm	2	28MV-14
15.0 mm	2	28MV-15
16.0 mm	2	28MV-16
17.0 mm	2	28MV-17
18.0 mm	2	28MV-18
19.0 mm	2	28MV-19
20.0 mm	2	28MV-20
21.0 mm	2	28MV-21
22.0 mm	2	28MV-22



Isolerade insexskruvmejslar



1999MV



3 mm	5	1999MV-3
4 mm	5	1999MV-4
5 mm	5	1999MV-5
6 mm	5	1999MV-6
7 mm	5	1999MV-7
8 mm	5	1999MV-8
9 mm	5	1999MV-9
10 mm	3	1999MV-10
12 mm	3	1999MV-12



12 mm	10	7800DMV-12
13 mm	10	7800DMV-13
14 mm	10	7800DMV-14
15 mm	10	7800DMV-15
16 mm	10	7800DMV-16
17 mm	10	7800DMV-17
18 mm	10	7800DMV-18
19 mm	10	7800DMV-19
20 mm	10	7800DMV-20
21 mm	10	7800DMV-21
22 mm	10	7800DMV-22
24 mm	5	7800DMV-24
27 mm	5	7800DMV-27
30 mm	5	7800DMV-30
32 mm	5	7800DMV-32

1/2" VDE-isolerat spärrhandtag, 270 mm



8150-1/2V

270 mm	1	8150-1/2V
--------	---	-----------



ISOLERADE HYLSOR OCH SPÄRRHANDTAG



1/2" VDE-isolerade hylsor 8 mm–32 mm



7800DMV

8 mm	10	7800DMV-8
10 mm	10	7800DMV-10
11 mm	10	7800DMV-11



1/2" VDE-isolerade T-handtag, 200 mm



8154-1/2V

200 mm	190 mm	1	8154-1/2V
--------	--------	---	-----------



1/2" VDE-isolerade förlängare 125 mm–250 mm



8160-1/2V-8162-1/2V



125 mm	1	8160-1/2V
250 mm	1	8162-1/2V

Isolerade raka knivar



2820VP



50 mm	180 mm	2
		2820VP

Isolerade kabelknivar med eggskydd av plast



2820VDE



55.5 mm	180 mm	10
		2820VDE

SAXAR OCH KNIVAR

Isolerad elektrikersax med fingerskydd



SC127V



50 mm	130 mm	5
		SC127V

VDE-isolerade böjda knivar



2820VPC



50 mm	180 mm	2
		2820VPC

PINCETTER

Isolerad universalpincett 150 mm



2820VTEE



145 mm		1
		2820VTEE

Isolerad elektrikersax



SC150NGV



38 mm	150 mm	5
		SC150NGV

Isolerade böjda knivar med guide



2820VHELP



38 mm	180 mm	1
		2820VHELP

SKYDSSUTRUSTNING

Handske för NH-säkringar, storlek NH 00-3



2820VFP



458 g		1
		2820VFP



Isoleringsmattor för 1000 V AC



2820VM

1000 mm	1000 mm	1	2820VM



Isolerande skyddshandskar, 550 VAC-1000 VAC



2820VG

500 V	1 2820VG05
1000 V	1 2820VG10



Bomullshandskar att ha inuti isolerade handskar



2820VGCOT

50 g	1 2820VGCOT

Bomullshandskar att ha inuti isolerade handskar

VERKTYGSSATSER

ERGO™ verktygssats med allroundtänger – 3 delar



ergo®



9897S/3

3	50 x 180 x 400 mm	1	9897S/3

2628 S-180



2101S-160



2430 S-200



Sats med isolerade u-nycklar–8 delar



6MV/

8 mm	1	6MV/8T	



6MV-10, 6MV-11, 6MV-12, 6MV-13,
6MV-14, 6MV-17, 6MV-18, 6MV-19



Sats med isolerade u-nycklar–10 delar



6MV/10T_1

10 mm	1	6MV/10T	



6MV-10, 6MV-11, 6MV-12, 6MV-13,
6MV-14, 6MV-16, 6MV-17, 6MV-18,
6MV-19, 6MV-22



1/2" VDE-isolerad hyllsats–11 delar



7811DMV

11	270 x 79 x 350 mm	1	7811DMV



7800DMV-13, 7800DMV-10, 7800DMV-11,
7800DMV-22, 7800DMV-17,
7800DMV-19, 7800DMV-20



8150-1/2V



8154-1/2V



8160-1/2V



BE-8050S



BAHCO

Sats med elektrikerverktyg i vikbar, isolerad väska – 10 delar



3045/1VDE

10 225 x 70 x 300 mm 1 3045/1VDE

BE-8010S, BE-8040S, BE-8050S, BE-8220S, BE-8230S, BE-8255S		
BE-8620S		
2171V-160		
2430V-160		
2678V-180		

Sats med elektrikerverktyg i isolerad läderväska – 10 delar



3045V-1

10 60 x 240 x 330 mm 1 3045V-1

2171V-160		
2678V-180		
2223V-160		
BE-8220S, BE-8040S, BE-8050S		
BE-8610S, BE-8620S		
2820VP		
SC127V		

Isolerad verktygssats i läderväska–19 delar



3045V-2

19 200 x 285 x 445 mm 1 3045V-2

2171V-160		
2678V-180		
2430V-160		
2223V-160		
BE-8220S, BE-8040S, BE-8050S, BE-8255S		
BE-8610S, BE-8620S		
6MV-10, 6MV-11, 6MV-13, 6MV-12, 6MV-14, 6MV-17, 6MV-19		
2820VP		
SC150NGV		





BAHCO



Gnistfria verktyg



DRAGVERKTYG

Gnistfri skiftnyckel av aluminium-brons



NS001

Öppningsstorlek	Längd	Antal	Modell
18 mm	150mm/6"	5	NS001-150
24 mm	200mm/8"	5	NS001-200
30 mm	250mm/10"	5	NS001-250
36 mm	300mm/12"	5	NS001-300
46 mm	375mm/15"	5	NS001-375
55 mm	450mm/18"	3	NS001-450
65 mm	600mm/24"	1	NS001-600
75 mm	900mm/36"	1	NS001-900

Gnistfri skiftnyckel i koppar-beryllium



NSB001

Öppningsstorlek	Längd	Antal	Modell
18 mm	150mm/6"	5	NSB001-150
24 mm	200mm/8"	5	NSB001-200
30 mm	250mm/10"	5	NSB001-250
36 mm	300mm/12"	5	NSB001-300
48 mm	375mm/15"	5	NSB001-375
55 mm	450mm/18"	3	NSB001-450
65 mm	600mm/24"	3	NSB001-600
75 mm	900mm/36"	1	NSB001-900

BAM/ZBF/003/21

Gnistfria, metrisk u-nycklar av aluminium-brons



NS002

Öppningsstorlek	Antal	Modell
6 mm	5	NS002-6
7 mm	5	NS002-7
8 mm	5	NS002-8
9 mm	5	NS002-9



10 mm	10	NS002-10
11 mm	5	NS002-11
12 mm	5	NS002-12
13 mm	10	NS002-13
14 mm	5	NS002-14
15 mm	5	NS002-15
16 mm	5	NS002-16
17 mm	10	NS002-17
18 mm	5	NS002-18
19 mm	10	NS002-19
20 mm	5	NS002-20
21 mm	5	NS002-21
22 mm	10	NS002-22
23 mm	5	NS002-23
24 mm	10	NS002-24
25 mm	5	NS002-25
26 mm	5	NS002-26
27 mm	5	NS002-27
28 mm	5	NS002-28
29 mm	10	NS002-29
30 mm	10	NS002-30
31 mm	5	NS002-31
32 mm	5	NS002-32
33 mm	5	NS002-33
34 mm	5	NS002-34
35 mm	5	NS002-35
36 mm	5	NS002-36
38 mm	5	NS002-38
40 mm	5	NS002-40
41 mm	5	NS002-41
42 mm	5	NS002-42
46 mm	5	NS002-46
50 mm	5	NS002-50
52 mm	5	NS002-52
55 mm	5	NS002-55
60 mm	1	NS002-60
65 mm	1	NS002-65
70 mm	1	NS002-70
75 mm	1	NS002-75
80 mm	1	NS002-80

BAM/ZBF/002/21

Gnistfri u-ringnyckel med metrisk dimensioner i koppar-beryllium



NSB002

Öppningsstorlek	Antal	Modell
6 mm	5	NSB002-6
7 mm	5	NSB002-7
8 mm	5	NSB002-8
9 mm	5	NSB002-9
10 mm	5	NSB002-10
11 mm	5	NSB002-11
12 mm	5	NSB002-12
13 mm	5	NSB002-13
17 mm	5	NSB002-17
14 mm	5	NSB002-14
15 mm	5	NSB002-15
16 mm	5	NSB002-16
18 mm	5	NSB002-18
19 mm	5	NSB002-19
20 mm	5	NSB002-20
21 mm	5	NSB002-21
22 mm	5	NSB002-22
25 mm	5	NSB002-25
23 mm	5	NSB002-23
26 mm	5	NSB002-26



24 mm	5	NSB002-24
27 mm	5	NSB002-27
28 mm	5	NSB002-28
29 mm	5	NSB002-29
30 mm	5	NSB002-30
31 mm	1	NSB002-31
32 mm	10	NSB002-32
33 mm	1	NSB002-33
34 mm	1	NSB002-34
35 mm	1	NSB002-35
36 mm	5	NSB002-36
38 mm	1	NSB002-38
40 mm	1	NSB002-40
41 mm	5	NSB002-41
42 mm	1	NSB002-42
46 mm	1	NSB002-46
50 mm	1	NSB002-50
52 mm	1	NSB002-52
55 mm	1	NSB002-55
60 mm	1	NSB002-60
65 mm	1	NSB002-65
70 mm	1	NSB002-70
75 mm	1	NSB002-75
80 mm	1	NSB002-80

BAM/ZBF/003/21

Gnistfri u-ringnyckel i aluminium-brons, i tum-storlekar



NS003



Öppningsstorlek	Antal	Modell
1/4 in	1	NS003-8
11/32 in	1	NS003-11
3/8 in	1	NS003-12
7/16 in	1	NS003-14
1/2 in	1	NS003-16
9/16 in	1	NS003-18
5/8 in	1	NS003-20
3/4 in	1	NS003-24
7/8 in	1	NS003-28
15/16 in	1	NS003-30

Gnistfri u-ringnyckel i koppar-beryllium, i tum-storlekar



NSB003

Öppningsstorlek	Antal	Modell
1/4 in	1	NSB003-8
5/16 in	1	NSB003-10
11/32 in	1	NSB003-11
3/8 in	5	NSB003-12



	 	
13/32 in	1	NSB003-13
7/16 in	1	NSB003-14
1/2 in	5	NSB003-16
9/16 in	1	NSB003-18
19/32 in	1	NSB003-19
5/8 in	1	NSB003-20
11/16 in	5	NSB003-22
3/4 in	5	NSB003-24
25/32 in	1	NSB003-25
13/16 in	1	NSB003-26
7/8 in	5	NSB003-28
15/16 in	1	NSB003-30
31/32 in	1	NSB003-31
1 in	1	NSB003-32
1.1/16 in	1	NSB003-34
1.1/8 in	1	NSB003-36
1.3/16 in	1	NSB003-38
1.1/4 in	1	NSB003-40
1.5/16 in	1	NSB003-42
1.3/8 in	5	NSB003-44
1.7/16 in	1	NSB003-46
1.1/2 in	1	NSB003-48
1.9/16 in	1	NSB003-50
1.5/8 in	1	NSB003-52
1.11/16 in	1	NSB003-54
1.3/4 in	1	NSB003-56
1.13/16 in	1	NSB003-58
1.7/8 in	1	NSB003-60
1.15/16 in	1	NSB003-62
2 in	5	NSB003-64
2.1/8 in	1	NSB003-68
2.1/4 in	1	NSB003-72
2.1/2 in	1	NSB003-80
2.5/8 in	1	NSB003-84
2.3/4 in	1	NSB003-88



BAM/ZBF/003/21

Gnistfria, metriska dubbla u-nycklar av aluminium-brons



NS006

	 	
6x7 mm	1	NS006-0607
6x8 mm	1	NS006-0608
7x8 mm	1	NS006-0708
7x9 mm	1	NS006-0709
8x9 mm	1	NS006-0809
8x10 mm	1	NS006-0810
9x10 mm	1	NS006-0910
9x11 mm	1	NS006-0911
10x11 mm	1	NS006-1011
10x12 mm	1	NS006-1012
10x13 mm	1	NS006-1013
10x14 mm	1	NS006-1014
11x13 mm	1	NS006-1113
11x14 mm	1	NS006-1114
12x13 mm	1	NS006-1213
12x14 mm	1	NS006-1214
13x15 mm	1	NS006-1315
14x15 mm	1	NS006-1415
14x16 mm	1	NS006-1416



	 	
14x17 mm	1	NS006-1417
16x17 mm	1	NS006-1617
16x18 mm	1	NS006-1618
17x19 mm	1	NS006-1719
17x22 mm	1	NS006-1722
18x19 mm	1	NS006-1819
18x20 mm	1	NS006-1820
19x20 mm	1	NS006-1920
19x22 mm	1	NS006-1922
19x24 mm	1	NS006-1924
20x22 mm	1	NS006-2022
21x22 mm	1	NS006-2122
21x23 mm	1	NS006-2123
22x23 mm	1	NS006-2223
22x24 mm	1	NS006-2224
22x27 mm	1	NS006-2227
23x26 mm	1	NS006-2326
24x25 mm	1	NS006-2425
24x26 mm	1	NS006-2426
24x27 mm	1	NS006-2427
24x30 mm	1	NS006-2430
25x28 mm	1	NS006-2528
26x29 mm	1	NS006-2629
27x29 mm	1	NS006-2729
27x30 mm	1	NS006-2730
27x32 mm	1	NS006-2732
28x30 mm	1	NS006-2830
30x31 mm	1	NS006-3031
30x32 mm	1	NS006-3032
30x34 mm	1	NS006-3034
30x36 mm	1	NS006-3036
32x34 mm	1	NS006-3234
32x35 mm	1	NS006-3235
32x36 mm	1	NS006-3236
33x35 mm	1	NS006-3335
34x36 mm	1	NS006-3436
35x36 mm	1	NS006-3536
36x38 mm	1	NS006-3638
36x41 mm	1	NS006-3641
38x42 mm	1	NS006-3642
41x46 mm	1	NS006-4146
46x50 mm	1	NS006-4650
50x52 mm	1	NS006-5052
50x55 mm	1	NS006-5055
50x60 mm	1	NS006-5060
50x62 mm	1	NS006-5062
55x60 mm	1	NS006-5560
60x65 mm	1	NS006-6065
65x70 mm	1	NS006-6570



BAM/ZBF/002/21

Gnistfria metriska dubbla u-nycklar i koppar-beryllium



NSB006

	 	
6X7 mm	1	NSB006-0607
6X8 mm	1	NSB006-0608
7X8 mm	1	NSB006-0708
7X9 mm	1	NSB006-0709

	 	
8X9 mm	1	NSB006-0809
8X10 mm	1	NSB006-0810
9X10 mm	1	NSB006-0910
9X11 mm	1	NSB006-0911
10X11 mm	1	NSB006-1011
10X12 mm	1	NSB006-1012
10X13 mm	1	NSB006-1013
10X14 mm	1	NSB006-1014
11X13 mm	1	NSB006-1113
11X14 mm	1	NSB006-1114
12X13 mm	1	NSB006-1213
12X14 mm	1	NSB006-1214
13X15 mm	1	NSB006-1315
14X15 mm	1	NSB006-1415
14X16 mm	1	NSB006-1416
14X17 mm	1	NSB006-1417
16X17 mm	1	NSB006-1617
16X18 mm	1	NSB006-1618
17X19 mm	1	NSB006-1719
17X22 mm	1	NSB006-1722
18X19 mm	1	NSB006-1819
18X20 mm	1	NSB006-1820
19X20 mm	1	NSB006-1920
19X22 mm	1	NSB006-1922
19X24 mm	1	NSB006-1924
20X22 mm	1	NSB006-2022
21X22 mm	1	NSB006-2122
21X23 mm	1	NSB006-2123
22X23 mm	1	NSB006-2223
22X24 mm	1	NSB006-2224
22X27 mm	1	NSB006-2227
23X26 mm	1	NSB006-2326
24X25 mm	1	NSB006-2425
24X26 mm	1	NSB006-2426
24X27 mm	1	NSB006-2427
24x30 mm	1	NSB006-2430
25x28 mm	1	NSB006-2528
26x29 mm	1	NSB006-2629
27-29 mm	1	NSB006-2729
27x30 mm	1	NSB006-2730
27x32 mm	1	NSB006-2732
28x30 mm	1	NSB006-2830
30x31 mm	1	NSB006-3031
30x32 mm	1	NSB006-3032
30x34 mm	1	NSB006-3034
30x36 mm	1	NSB006-3036
32x34 mm	1	NSB006-3234
32x35 mm	1	NSB006-3235
32x36 mm	1	NSB006-3236
33x35 mm	1	NSB006-3335
34x36 mm	1	NSB006-3436
35x36 mm	1	NSB006-3536
36x38 mm	1	NSB006-3638
36x41 mm	1	NSB006-3641
38x42 mm	1	NSB006-3642
41x46 mm	1	NSB006-4146
46x50 mm	1	NSB006-4650
50x52 mm	1	NSB006-5052
50x55 mm	1	NSB006-5055
50x60 mm	1	NSB006-5060
50x62 mm	1	NSB006-5062
55x60 mm	1	NSB006-5560
60X65 mm	1	NSB006-6065
65X70 mm	1	NSB006-6570

BAM/ZBF/003/21



Gnistfria, metriska dubbla ringnycklar av aluminium-brons



NS10

Size	Quantity	Part Number
6x7 mm	1	NS010-0607
7x9 mm	1	NS010-0709
8x9 mm	1	NS010-0809
9x11 mm	1	NS010-0911
10x11 mm	1	NS010-1011
10x12 mm	1	NS010-1012
12x14 mm	1	NS010-1214
13x15 mm	1	NS010-1315
14x17 mm	1	NS010-1417
16x18 mm	1	NS010-1618
17x19 mm	1	NS010-1719
17x22 mm	1	NS010-1722
18x19 mm	1	NS010-1819
19x21 mm	1	NS010-1921
19x22 mm	1	NS010-1922
20x22 mm	1	NS010-2022
21x23 mm	1	NS010-2123
22x24 mm	1	NS010-2224
24x27 mm	1	NS010-2427
25x28 mm	1	NS010-2528
26x28 mm	1	NS010-2628
27x30 mm	1	NS010-2730
27x32 mm	1	NS010-2732
30x32 mm	1	NS010-3032
30x36 mm	1	NS010-3036
32x36 mm	1	NS010-3236
36x41 mm	1	NS010-3641
41x46 mm	1	NS010-4146
46x50 mm	1	NS010-4650

BAM/ZBF/002/21

Gnistfria metriska dubbla ringnycklar i koppar-beryllium



NSB010

Size	Quantity	Part Number
6x7 mm	1	NSB010-0607
7x9 mm	1	NSB010-0709
8x9 mm	1	NSB010-0809
9x11 mm	1	NSB010-0911

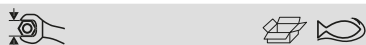

Size	Quantity	Part Number
10X11 mm	1	NSB010-1011
10X12 mm	1	NSB010-1012
12X14 mm	1	NSB010-1214
13X15 mm	1	NSB010-1315
14X17 mm	1	NSB010-1417
16X18 mm	1	NSB010-1618
17X19 mm	1	NSB010-1719
17X22 mm	1	NSB010-1722
18X19 mm	1	NSB010-1819
19X21 mm	1	NSB010-1921
19X22 mm	1	NSB010-1922
20X22 mm	1	NSB010-2022
21X23 mm	1	NSB010-2123
22X24 mm	1	NSB010-2224
24X27 mm	1	NSB010-2427
25X28 mm	1	NSB010-2528
26X28 mm	1	NSB010-2628
27X30 mm	1	NSB010-2730
27X32 mm	1	NSB010-2732
30X32 mm	1	NSB010-3032
30X36 mm	1	NSB010-3036
32X36 mm	1	NSB010-3236
36X41 mm	1	NSB010-3641
41X46 mm	1	NSB010-4146
46X50 mm	1	NSB010-4650

BAM/ZBF/003/21

Gnistfria, metriska dubbla bockade ringnycklar av aluminium-brons



NS011

Size	Quantity	Part Number
6x7 mm	1	NS011-0607
8x9 mm	1	NS011-0809
10x11 mm	1	NS011-1011
12x13 mm	1	NS011-1213
14x15 mm	1	NS011-1415
16x17 mm	1	NS011-1617
18x19 mm	1	NS011-1819
20x22 mm	1	NS011-2022
21x23 mm	1	NS011-2123
24x26 mm	1	NS011-2426
25x28 mm	1	NS011-2528
27x29 mm	1	NS011-2729
30x32 mm	1	NS011-3032

BAM/ZBF/002/21

Gnistfri metrisk bockad dubbel ringnyckel i koppar-beryllium



NSB011

Size	Quantity	Part Number
6x7 mm	1	NSB011-0607
8x9 mm	1	NSB011-0809
10x11 mm	1	NSB011-1011
12x13 mm	1	NSB011-1213
14x15 mm	1	NSB011-1415
16x17 mm	1	NSB011-1617
18x19 mm	1	NSB011-1819
20x22 mm	1	NSB011-2022
21x23 mm	1	NSB011-2123
24x26 mm	1	NSB011-2426
25x28 mm	1	NSB011-2528
27x29 mm	1	NSB011-2729
30x32 mm	1	NSB011-3032



BAM/ZBF/003/21

Gnistfri u-slagnyckel med metriska dimensioner i aluminium-brons



NS100

Size	Quantity	Part Number
17 mm	1	NS100-17
19 mm	1	NS100-19
22 mm	1	NS100-22
24 mm	1	NS100-24
25 mm	1	NS100-25
27 mm	1	NS100-27
28 mm	1	NS100-28
29 mm	1	NS100-29
30 mm	1	NS100-30
32 mm	1	NS100-32
33 mm	1	NS100-33
34 mm	1	NS100-34
35 mm	1	NS100-35
36 mm	1	NS100-36
37 mm	1	NS100-37
38 mm	1	NS100-38
41 mm	1	NS100-41
42 mm	1	NS100-42
45 mm	1	NS100-45



	 
46 mm	1 NS100-46
47 mm	1 NS100-47
50 mm	1 NS100-50
52 mm	1 NS100-52
54 mm	1 NS100-54
55 mm	1 NS100-55
56 mm	1 NS100-56
58 mm	1 NS100-58
60 mm	1 NS100-60
63 mm	1 NS100-63
65 mm	1 NS100-65
67 mm	1 NS100-67
70 mm	1 NS100-70
71 mm	1 NS100-71
75 mm	1 NS100-75
77 mm	1 NS100-77
80 mm	1 NS100-80
82 mm	1 NS100-82
85 mm	1 NS100-85
88 mm	1 NS100-88
90 mm	1 NS100-90
94 mm	1 NS100-94
95 mm	1 NS100-95
100 mm	1 NS100-100
105 mm	1 NS100-105
110 mm	1 NS100-110
115 mm	1 NS100-115
120 mm	1 NS100-120

BAM/ZBF/002/21

Gnistfri metrisk u-slagnyckel i kopparberyllium



NSB100

	 
17 mm	1 NSB100-17
19 mm	1 NSB100-19
22 mm	1 NSB100-22
24 mm	1 NSB100-24
25 mm	1 NSB100-25
27 mm	1 NSB100-27
28 mm	1 NSB100-28
29 mm	1 NSB100-29
30 mm	1 NSB100-30
32 mm	1 NSB100-32
33 mm	1 NSB100-33
34 mm	1 NSB100-34
35 mm	1 NSB100-35
36 mm	1 NSB100-36
37 mm	1 NSB100-37
38 mm	1 NSB100-38
41 mm	1 NSB100-41



	 
42 mm	1 NSB100-42
45 mm	1 NSB100-45
46 mm	1 NSB100-46
47 mm	1 NSB100-47
50 mm	1 NSB100-50
52 mm	1 NSB100-52
54 mm	1 NSB100-54
55 mm	1 NSB100-55
56 mm	1 NSB100-56
58 mm	1 NSB100-58
60 mm	1 NSB100-60
63 mm	1 NSB100-63
65 mm	1 NSB100-65
67 mm	1 NSB100-67
70 mm	1 NSB100-70
71 mm	1 NSB100-71
75 mm	1 NSB100-75
77 mm	1 NSB100-77
80 mm	1 NSB100-80
82 mm	1 NSB100-82
85 mm	1 NSB100-85
88 mm	1 NSB100-88
90 mm	1 NSB100-90
94 mm	1 NSB100-94
95 mm	1 NSB100-95
100 mm	1 NSB100-100
105 mm	1 NSB100-105
110 mm	1 NSB100-110
115 mm	1 NSB100-115
120 mm	1 NSB100-120



BAM/ZBF/003/21

Gnistfri ring-slagnyckel med metriska dimensioner i aluminium-brons



NS104

	 
17 mm	1 NS104-17
19 mm	1 NS104-19
20 mm	1 NS104-20
22 mm	1 NS104-22
24 mm	1 NS104-24
25 mm	1 NS104-25
26 mm	1 NS104-26
27 mm	1 NS104-27
28 mm	1 NS104-28
29 mm	1 NS104-29
30 mm	1 NS104-30

	 
31 mm	1 NS104-31
32 mm	1 NS104-32
33 mm	1 NS104-33
34 mm	1 NS104-34
35 mm	1 NS104-35
36 mm	1 NS104-36
37 mm	1 NS104-37
38 mm	1 NS104-38
39 mm	1 NS104-39
40 mm	1 NS104-40
41 mm	1 NS104-41
42 mm	1 NS104-42
43 mm	1 NS104-43
44 mm	1 NS104-44
45 mm	1 NS104-45
46 mm	1 NS104-46
47 mm	1 NS104-47
48 mm	1 NS104-48
49 mm	1 NS104-49
50 mm	1 NS104-50
51 mm	1 NS104-51
52 mm	1 NS104-52
53 mm	1 NS104-53
54 mm	1 NS104-54
55 mm	1 NS104-55
56 mm	1 NS104-56
57 mm	1 NS104-57
58 mm	1 NS104-58
59 mm	1 NS104-59
60 mm	1 NS104-60
61 mm	1 NS104-61
62 mm	1 NS104-62
63 mm	1 NS104-63
64 mm	1 NS104-64
65 mm	1 NS104-65
66 mm	1 NS104-66
67 mm	1 NS104-67
68 mm	1 NS104-68
69 mm	1 NS104-69
70 mm	1 NS104-70
71 mm	1 NS104-71
72 mm	1 NS104-72
73 mm	1 NS104-73
74 mm	1 NS104-74
75 mm	1 NS104-75
76 mm	1 NS104-76
77 mm	1 NS104-77
78 mm	1 NS104-78
79 mm	1 NS104-79
80 mm	1 NS104-80
81 mm	1 NS104-81
82 mm	1 NS104-82
83 mm	1 NS104-83
84 mm	1 NS104-84
85 mm	1 NS104-85
86 mm	1 NS104-86
87 mm	1 NS104-87
88 mm	1 NS104-88
89 mm	1 NS104-89
90 mm	1 NS104-90
92 mm	1 NS104-92
94 mm	1 NS104-94
95 mm	1 NS104-95
98 mm	1 NS104-98
100 mm	1 NS104-100
105 mm	1 NS104-105
110 mm	1 NS104-110
115 mm	1 NS104-115
120 mm	1 NS104-120

BAM/ZBF/002/21



Gnistfri metrisk slagringnyckel i koppar-beryllium



NSB104



17 mm	1	NSB104-17
19 mm	1	NSB104-19
20 mm	1	NSB104-20
22 mm	1	NSB104-22
24 mm	1	NSB104-24
25 mm	1	NSB104-25
26 mm	1	NSB104-26
27 mm	1	NSB104-27
28 mm	1	NSB104-28
29 mm	1	NSB104-29
30 mm	1	NSB104-30
31 mm	1	NSB104-31
32 mm	1	NSB104-32
33 mm	1	NSB104-33
34 mm	1	NSB104-34
35 mm	1	NSB104-35
36 mm	1	NSB104-36
37 mm	1	NSB104-37
38 mm	1	NSB104-38
39 mm	1	NSB104-39
40 mm	1	NSB104-40
41 mm	1	NSB104-41
42 mm	1	NSB104-42
43 mm	1	NSB104-43
44 mm	1	NSB104-44
45 mm	1	NSB104-45
46 mm	1	NSB104-46
47 mm	1	NSB104-47
48 mm	1	NSB104-48
49 mm	1	NSB104-49
50 mm	1	NSB104-50
51 mm	1	NSB104-51
52 mm	1	NSB104-52
53 mm	1	NSB104-53
54 mm	1	NSB104-54
55 mm	1	NSB104-55
56 mm	1	NSB104-56
57 mm	1	NSB104-57
58 mm	1	NSB104-58
59 mm	1	NSB104-59
60 mm	1	NSB104-60
61 mm	1	NSB104-61
62 mm	1	NSB104-62
63 mm	1	NSB104-63
64 mm	1	NSB104-64
65 mm	1	NSB104-65
66 mm	1	NSB104-66
67 mm	1	NSB104-67
68 mm	1	NSB104-68
69 mm	1	NSB104-69
70 mm	1	NSB104-70
71 mm	1	NSB104-71
72 mm	1	NSB104-72
73 mm	1	NSB104-73
74 mm	1	NSB104-74
75 mm	1	NSB104-75
76 mm	1	NSB104-76
77 mm	1	NSB104-77



78 mm	1	NSB104-78
79 mm	1	NSB104-79
80 mm	1	NSB104-80
81 mm	1	NSB104-81
82 mm	1	NSB104-82
83 mm	1	NSB104-83
84 mm	1	NSB104-84
85 mm	1	NSB104-85
86 mm	1	NSB104-86
87 mm	1	NSB104-87
88 mm	1	NSB104-88
89 mm	1	NSB104-89
90 mm	1	NSB104-90
92 mm	1	NSB104-92
94 mm	1	NSB104-94
95 mm	1	NSB104-95
98 mm	1	NSB104-98
100 mm	1	NSB104-100
105 mm	1	NSB104-105
110 mm	1	NSB104-110
115 mm	1	NSB104-115
120 mm	1	NSB104-120

BAM/ZBF/003/21

Gnistfri ring-slagnyckel i aluminium-brons



NS106



5/8 in	1	NS106-20
11/16 in	1	NS106-22
3/4 in	1	NS106-24
25/32 in	1	NS106-25
13/16 in	1	NS106-26
7/8 in	1	NS106-28
15/16 in	1	NS106-30
1 in	1	NS106-32
1 1/16 in	1	NS106-34
1 1/8 in	1	NS106-36
1 3/16 in	1	NS106-38
1 1/4 in	1	NS106-40
1 5/16 in	1	NS106-42
1 3/8 in	1	NS106-44
1 13/32 in	1	NS106-45
1 7/16 in	1	NS106-46
1 1/2 in	1	NS106-48
1 9/16 in	1	NS106-50
1 5/8 in	1	NS106-52
1 11/16 in	1	NS106-54
1 3/4 in	1	NS106-56
1 13/16 in	1	NS106-58
1 7/8 in	1	NS106-60
1 15/16 in	1	NS106-62
2 in	1	NS106-64
2 1/16 in	1	NS106-66
2 1/8 in	1	NS106-68
2 3/16 in	1	NS106-70
2 13/64 in	1	NS106-71
2 1/4 in	1	NS106-72
2 5/16 in	1	NS106-74



2 3/8 in	1	NS106-76
2 7/16 in	1	NS106-78
2 1/2 in	1	NS106-80
2 9/16 in	1	NS106-82
2 5/8 in	1	NS106-84
2 3/4 in	1	NS106-88
2 13/16 in	1	NS106-90
2 7/8 in	1	NS106-92
2 15/16 in	1	NS106-94
3 in	1	NS106-96
3 1/16 in	1	NS106-98
3 1/8 in	1	NS106-100
3 1/4 in	1	NS106-104
3 3/8 in	1	NS106-108
3 1/2 in	1	NS106-112
3 9/16 in	1	NS106-114
3 5/8 in	1	NS106-116
3 3/4 in	1	NS106-120
3 7/8 in	1	NS106-124
3 15/16 in	1	NS106-126
4 in	1	NS106-128
4 1/8 in	1	NS106-132
4 1/4 in	1	NS106-136
4 5/16 in	1	NS106-138
4 1/2 in	1	NS106-144
4 9/16 in	1	NS106-146
4 11/16 in	1	NS106-150
4 7/8 in	1	NS106-156
4 15/16 in	1	NS106-158

BAM/ZBF/002/21



Gnistfri slagringnyckel med tum-skala i koppar-beryllium



NSB106



5/8 in	1	NSB106-20
11/16 in	1	NSB106-22
3/4 in	1	NSB106-24
25/32 in	1	NSB106-25
13/16 in	1	NSB106-26
7/8 in	1	NSB106-28
15/16 in	1	NSB106-30
1 in	1	NSB106-32
1.1/16 in	1	NSB106-34
1.1/8 in	1	NSB106-36
1.3/16 in	1	NSB106-38
1.1/4 in	1	NSB106-40
1.5/16 in	1	NSB106-42
1.3/8 in	1	NSB106-44
1.13/32 in	1	NSB106-45
1.7/16 in	1	NSB106-46
1.1/2 in	1	NSB106-48
1.9/16 in	1	NSB106-50
1.5/8 in	1	NSB106-52
1.11/16 in	1	NSB106-54
1.3/4 in	1	NSB106-56
1.13/16 in	1	NSB106-58
1.7/8 in	1	NSB106-60
1.15/16 in	1	NSB106-62

		
2 in	1	NSB106-64
2.1/16 in	1	NSB106-66
2.1/8 in	1	NSB106-68
2.3/16 in	1	NSB106-70
2.13/64 in	1	NSB106-71
2.1/4 in	1	NSB106-72
2.5/16 in	1	NSB106-74
2.3/8 in	1	NSB106-76
2.7/16 in	1	NSB106-78
2.1/2 in	1	NSB106-80
2.9/16 in	1	NSB106-82
2.5/8 in	1	NSB106-84
2.3/4 in	1	NSB106-88
2.13/16 in	1	NSB106-90
2.7/8 in	1	NSB106-92
2.15/16 in	1	NSB106-94
3 in	1	NSB106-96
3.1/16 in	1	NSB106-98
3.1/8 in	1	NSB106-100
3.1/4 in	1	NSB106-104
3.3/8 in	1	NSB106-108
3.1/2 in	1	NSB106-112
3.9/16 in	1	NSB106-114
3.5/8 in	1	NSB106-116
3.3/4 in	1	NSB106-120
3.7/8 in	1	NSB106-124
3.15/16 in	1	NSB106-126
4 in	1	NSB106-128
4.1/8 in	1	NSB106-132
4.1/4 in	1	NSB106-136
4.5/16 in	1	NSB106-138
4.1/2 in	1	NSB106-144
4.9/16 in	1	NSB106-146
4.11/16 in	1	NSB106-150
4.7/8 in	1	NSB106-156
4.15/16 in	1	NSB106-158





BAM/ZBF/003/21

RÖRVERKTYG OCH VENTILVERKTYG

Gnistfri extra kraftig rörtång i aluminium-brons



NS200





			
25 mm	200 mm	1	NS200-200
30 mm	250 mm	1	NS200-250
40 mm	300 mm	1	NS200-300
50 mm	350 mm	1	NS200-350
60 mm	450 mm	1	NS200-450
75 mm	600 mm	1	NS200-600
85 mm	900 mm	1	NS200-900
110 mm	1200 mm	1	NS200-1200

BAM/ZBF/002/21

Gnistfri extra kraftig rörtång i koppar-beryllium



NSB200

			
25 mm	200 mm	1	NSB200-200
30 mm	250 mm	1	NSB200-250
40 mm	300 mm	1	NSB200-300
50 mm	350 mm	1	NSB200-350
60 mm	450 mm	1	NSB200-450
75 mm	600 mm	1	NSB200-600
85 mm	900 mm	1	NSB200-900
110 mm	1200 mm	1	NSB200-1200

BAM/ZBF/003/21

Gnistfri lång ventilnyckel i aluminium-brons



NS202

			
370 mm		1	NS202-350

BAM/ZBF/002/21

Gnistfri lång ventilnyckel i koppar-beryllium



NSB202

			
375 mm		1	NSB202-350





BAM/ZBF/003/21

Gnistfri ventilnyckel i aluminium-brons



NS203

				
215 mm	24 mm		1	NS203-200
215 mm	32 mm		1	NS203-215





			
290 mm	36 mm	1	NS203-290
400 mm	48 mm	1	NS203-400
490 mm	60 mm	1	NS203-490
800 mm	60 mm	1	NS203-800

BAM/ZBF/002/21

Gnistfri ventilnyckel i koppar-beryllium



NSB203



			
215 mm	24 mm	1	NSB203-200
215 mm	32 mm	1	NSB203-215
290 mm	36 mm	1	NSB203-290
400 mm	48 mm	1	NSB203-400
490 mm	60 mm	1	NSB203-490
800 mm	60 mm	1	NSB203-800

BAM/ZBF/003/21

Gnistfri ventilnyckel i aluminium-brons



NS204

		
200 mm	1	NS204-30
300 mm	1	NS204-32
250 mm	1	NS204-35
300 mm	1	NS204-40
350 mm	1	NS204-45
375 mm	1	NS204-48
400 mm	1	NS204-50
450 mm	1	NS204-55
500 mm	1	NS204-60
550 mm	1	NS204-65
600 mm	1	NS204-70
650 mm	1	NS204-75
700 mm	1	NS204-80
750 mm	1	NS204-85
800 mm	1	NS204-90

BAM/ZBF/002/21



Gnistfria ventilycklar i koppar-beryllium



NSB204



200 mm	1	NSB204-30
300 mm	1	NSB204-32
250 mm	1	NSB204-35
300 mm	1	NSB204-40
350 mm	1	NSB204-45
375 mm	1	NSB204-48
400 mm	1	NSB204-50
450 mm	1	NSB204-55
500 mm	1	NSB204-60
550 mm	1	NSB204-65
600 mm	1	NSB204-70
650 mm	1	NSB204-75
700 mm	1	NSB204-80
750 mm	1	NSB204-85
800 mm	1	NSB204-90

BAM/ZBF/003/21

HYLSOR OCH SPÄRRHANDTAG

1/2" gnistfria hylsor med sexkantsprofil och aluminium-brons



NS220



6 mm	1	NS220-06
7 mm	1	NS220-07
8 mm	1	NS220-08
9 mm	1	NS220-09
10 mm	1	NS220-10
11 mm	1	NS220-11
12 mm	1	NS220-12
13 mm	1	NS220-13
14 mm	1	NS220-14
15 mm	1	NS220-15
16 mm	1	NS220-16
17 mm	1	NS220-17

NSB220



6 mm	1	NSB220-06
7 mm	1	NSB220-07
8 mm	1	NSB220-08
9 mm	1	NSB220-09
10 mm	1	NSB220-10
11 mm	1	NSB220-11
12 mm	1	NSB220-12
13 mm	1	NSB220-13
14 mm	1	NSB220-14
15 mm	1	NSB220-15
16 mm	1	NSB220-16
17 mm	1	NSB220-17
18 mm	1	NSB220-18
19 mm	1	NSB220-19
20 mm	1	NSB220-20
21 mm	1	NSB220-21
22 mm	1	NSB220-22
23 mm	1	NSB220-23
24 mm	1	NSB220-24
25 mm	1	NSB220-25
26 mm	1	NSB220-26
27 mm	1	NSB220-27
28 mm	1	NSB220-28
29 mm	1	NSB220-29
30 mm	1	NSB220-30
32 mm	1	NSB220-32

BAM/ZBF/003/21

3/4" gnistfria hylsor med sexkantsprofil och aluminium-brons



NS224



17 mm	1	NS224-17
18 mm	1	NS224-18
19 mm	1	NS224-19
21 mm	1	NS224-21
22 mm	1	NS224-22
23 mm	1	NS224-23
24 mm	1	NS224-24
26 mm	1	NS224-26
27 mm	1	NS224-27
28 mm	1	NS224-28
29 mm	1	NS224-29
30 mm	1	NS224-30
32 mm	1	NS224-32
34 mm	1	NS224-34
36 mm	1	NS224-36
38 mm	1	NS224-38
41 mm	1	NS224-41
46 mm	1	NS224-46
50 mm	1	NS224-50

BAM/ZBF/002/21

3/4" gnistfria hylsor med sexkantsprofil och koppar-beryllium



NSB224



17 mm	1	NSB224-17
18 mm	1	NSB224-18
19 mm	1	NSB224-19
21 mm	1	NSB224-21
22 mm	1	NSB224-22
23 mm	1	NSB224-23
24 mm	1	NSB224-24
26 mm	1	NSB224-26
27 mm	1	NSB224-27
28 mm	1	NSB224-28
29 mm	1	NSB224-29
30 mm	1	NSB224-30
32 mm	1	NSB224-32
34 mm	1	NSB224-34

Ø			
36 mm	1	NSB224-36	
38 mm	1	NSB224-38	
41 mm	1	NSB224-41	
46 mm	1	NSB224-46	
50 mm	1	NSB224-50	

BAM/ZBF/003/21

1" gnistfria hylsor med sexkantsprofil och aluminium-brons



NS228

Ø	L		
22 mm	55 mm	1	NS228-22
24 mm	55 mm	1	NS228-24
26 mm	55 mm	1	NS228-26
27 mm	55 mm	1	NS228-27
28 mm	55 mm	1	NS228-28
29 mm	55 mm	1	NS228-29
30 mm	60 mm	1	NS228-30
31 mm	60 mm	1	NS228-31
32 mm	60 mm	1	NS228-32
34 mm	60 mm	1	NS228-34
36 mm	65 mm	1	NS228-36
38 mm	65 mm	1	NS228-38
41 mm	70 mm	1	NS228-41
46 mm	75 mm	1	NS228-46
50 mm	75 mm	1	NS228-50
55 mm	80 mm	1	NS228-55
60 mm	85 mm	1	NS228-60
65 mm	90 mm	1	NS228-65
70 mm	90 mm	1	NS228-70
75 mm	95 mm	1	NS228-75
80 mm		1	NS228-80

BAM/ZBF/002/21

1" gnistfria hylsor med sexkantsprofil och koppar-beryllium



NSB228

Ø	g		
22 mm	370 g	1	NSB228-22
24 mm	430 g	1	NSB228-24
26 mm	396 g	1	NSB228-26
27 mm	440 g	1	NSB228-27

Ø	g		
28 mm	411 g	1	NSB228-28
29 mm	460 g	1	NSB228-29
30 mm	462 g	1	NSB228-30
31 mm	520 g	1	NSB228-31
32 mm	497 g	1	NSB228-32
34 mm	506 g	1	NSB228-34
36 mm	610 g	1	NSB228-36
38 mm	600 g	1	NSB228-38
41 mm	740 g	1	NSB228-41
46 mm	832 g	1	NSB228-46
50 mm	960 g	1	NSB228-50
55 mm	1130 g	1	NSB228-55
60 mm	1570 g	1	NSB228-60
65 mm	1698 g	1	NSB228-65
70 mm	2350 g	1	NSB228-70
75 mm	3010 g	1	NSB228-75
80 mm	2818 g	1	NSB228-80

BAM/ZBF/003/21

Gnistfria adaptrar i aluminium-brons



NS232

Ø	Ø		
1/2"	3/4"	1	NS232-16-24
3/4"	1/2"	1	NS232-24-16
3/4"	1"	1	NS232-24-32
1"	3/4"	1	NS232-32-24

BAM/ZBF/002/21

Gnistfria adaptrar i koppar-beryllium



NSB232

Ø	Ø		
1/2"	3/4"	1	NSB232-16-24
3/4"	1/2"	1	NSB232-24-16
3/4"	1"	1	NSB232-24-32
1"	3/4"	1	NSB232-32-24

BAM/ZBF/003/21

Gnistfria förlängningar i aluminium-brons



NS234

Ø	Ø		
1/2"	1/2"	1	NS234-16-100
1/2"	1/2"	1	NS234-16-200
1/2"	1/2"	1	NS234-16-250
3/4"	3/4"	1	NS234-24-200
1"	1"	1	NS234-32-250

BAM/ZBF/002/21

Gnistfria förlängare i koppar-beryllium



NSB234

L	Ø		
100 mm	16,4 mm	1	NSB234-16-100
200 mm	16,4 mm	1	NSB234-16-200
250 mm	16,4 mm	1	NSB234-16-250
200 mm	25 mm	1	NSB234-24-200
250 mm	34 mm	1	NSB234-32-250

BAM/ZBF/003/21

Gnistfri universalknut i aluminium-brons



NS236

Ø	Ø		
1/2"	1/2"	1	NS236-16
3/4"	3/4"	1	NS236-24
1"	1"	1	NS236-32

BAM/ZBF/002/21



Gnistfri universalknut i koppar-beryllium



NSB236

1/2"	1/2"	1	NSB236-16
3/4"	3/4"	1	NSB236-24
1"	1"	1	NSB236-32

BAM/ZBF/003/21

Gnistfri l-stångshandtag i aluminium-brons



NS240

1/2"	230 mm	1	NS240-16-230

BAM/ZBF/002/21

Gnistfritt spärrhandtag i koppar-beryllium



NSB242

245 mm	710 g	1	NSB242-16
320 mm	1660 g	1	NSB242-24
550 mm	3680 g	1	NSB242-32

BAM/ZBF/003/21

Gnistfritt t-stångshandtag i aluminium-brons



NS238

1/2"	250 mm	1	NS238-16-250
3/4"	260 mm	1	NS238-24-250
1"	300 mm	1	NS238-32-300

BAM/ZBF/002/21

Gnistfritt vinklat L-handtag i koppar-beryllium



NSB240

1/2"	370 g	1	NSB240-16-230

BAM/ZBF/003/21

Gnistfritt svänghandtag i aluminium-brons



NS243

1/2"	390 mm	1	NS243-16-400

BAM/ZBF/002/21

Gnistfritt t-stångshandtag i koppar-beryllium



NSB238

1/2"	250 mm	1	NSB238-16-250
3/4"	250 mm	1	NSB238-24-250
1"	300 mm	1	NSB238-32-300

BAM/ZBF/003/21

Gnistfritt spärrhandtag i aluminium-brons



NS242

245 mm	630 g	1	NS242-16
320 mm	1460 g	1	NS242-24
550 mm	3190 g	1	NS242-32

BAM/ZBF/002/21

Gnistfritt svänghandtag i koppar-beryllium



NSB243

1/2"	395 mm	1	NSB243-16-400

BAM/ZBF/003/21

Gnistfri tändstiftshylsa med sexkantsprofil och i aluminium-brons



NS247



1/2" 13 mm 1 NS247-26

BAM/ZBF/002/21

Gnistfria tändstiftshylsor med sexkantsprofil och koppar-beryllium



NSB247



1/2" 13 mm 1 NSB247-26

BAM/ZBF/003/21

Gnistfri bitshylsa i aluminium-brons



NS248



13 mm 1 NS248-16-52

BAM/ZBF/002/21

Gnistfri bitshylsa i koppar-beryllium



NSB248



13 mm 1 NSB248-16-52

BAM/ZBF/003/21

SKRUVMEJSLAR

Gnistfri skruvmejsel för spårskruv ERGO™ i aluminium-brons



ergo



NS300



3 mm	50 mm	1	NS300-3-50
3 mm	75 mm	1	NS300-3-75
4 mm	75 mm	1	NS300-4-75
4.5 mm	50 mm	1	NS300-4.5-50
4.5 mm	100 mm	1	NS300-4.5-100
5 mm	75 mm	1	NS300-5-75
5 mm	100 mm	1	NS300-5-100
6 mm	100 mm	1	NS300-6-100
6 mm	125 mm	1	NS300-6-125
6 mm	150 mm	1	NS300-6-150
7 mm	150 mm	1	NS300-7-150
8 mm	150 mm	1	NS300-8-150
8 mm	200 mm	1	NS300-8-200
9 mm	250 mm	1	NS300-9-250
10 mm	200 mm	1	NS300-10-200
10 mm	300 mm	1	NS300-10-300
11 mm	250 mm	1	NS300-11-250
11 mm	300 mm	1	NS300-11-300
11 mm	350 mm	1	NS300-11-350
12 mm	400 mm	1	NS300-12-400
13 mm	450 mm	1	NS300-13-450

BAM/ZBF/002/21

Gnistfri skruvmejsel för spårskruv ERGO™ i koppar-beryllium



ergo



NSB300

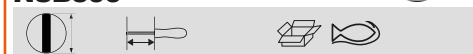

3 mm	50 mm	1	NSB300-3-50
3 mm	75 mm	1	NSB300-3-75
4 mm	75 mm	1	NSB300-4-75
4.5 mm	60 mm	1	NSB300-4.5-50
4.5 mm	95 mm	1	NSB300-4.5-100
5 mm	75 mm	1	NSB300-5-75
5 mm	100 mm	1	NSB300-5-100
6 mm	105 mm	1	NSB300-6-100
6 mm	125 mm	1	NSB300-6-125
6 mm	160 mm	1	NSB300-6-150
7 mm	150 mm	1	NSB300-7-150
8 mm	150 mm	1	NSB300-8-150
8 mm	200 mm	1	NSB300-8-200
9 mm	250 mm	1	NSB300-9-250
9 mm	200 mm	1	NSB300-10-200
10 mm	318 mm	1	NSB300-10-300
11 mm	250 mm	1	NSB300-11-250
11 mm	300 mm	1	NSB300-11-300
11 mm	350 mm	1	NSB300-11-350
12 mm	400 mm	1	NSB300-12-400
13 mm	450 mm	1	NSB300-13-450

BAM/ZBF/003/21

Gnistfri spårskruvmejsel med rak spets i aluminium-brons



ergo



NS301



3 mm	50 mm	1	NS301-3-50
4 mm	100 mm	1	NS301-4-100
4 mm	150 mm	1	NS301-4-150
5 mm	100 mm	1	NS301-5-100
5 mm	200 mm	1	NS301-5-200
6 mm	100 mm	1	NS301-6-100
8 mm	150 mm	1	NS301-8-150
10 mm	200 mm	1	NS301-10-200
10 mm	300 mm	1	NS301-10-300

BAM/ZBF/002/21



Gnistfri spårskruvmejsel med rak spets
ERGO™ i koppar-beryllium



ergo



NSB301

Spår	Längd	Antal	Modell
3 mm	50 mm	1	NSB301-3-50
4 mm	100 mm	1	NSB301-4-100
4 mm	150 mm	1	NSB301-4-150
5 mm	100 mm	1	NSB301-5-100
5 mm	210 mm	1	NSB301-5-200
6 mm	100 mm	1	NSB301-6-100
8 mm	155 mm	1	NSB301-8-150
10 mm	200 mm	1	NSB301-10-200
10 mm	300 mm	1	NSB301-10-300

BAM/ZBF/003/21

ERGO™ gnistfri skruvmejsel för Phillips-
skruv i aluminium-brons



ergo



NS302

Spår	Längd	Antal	Modell
PH0	50 mm	1	NS302-0-50
PH1	100 mm	1	NS302-1-100
PH2	125 mm	1	NS302-2-125
PH3	150 mm	1	NS302-3-150
PH4	300 mm	1	NS302-4-300

BAM/ZBF/002/21

Gnistfri skruvmejsel för Phillips-skruv
ERGO™ i koppar-beryllium



ergo



NSB302

Spår	Längd	Antal	Modell
PH0	65 mm	1	NSB302-0-50
PH1	120 mm	1	NSB302-1-100
PH2	125 mm	1	NSB302-2-125
PH3	150 mm	1	NSB302-3-150
PH4	300 mm	1	NSB302-4-300

BAM/ZBF/003/21

ERGO™ gnistfri skruvmejsel för Pozidriv-
skruv i aluminium-brons



ergo



NS304

Spår	Längd	Antal	Modell
PZ0	50 mm	1	NS304-0-50
PZ1	100 mm	1	NS304-1-100
PZ2	125 mm	1	NS304-2-125
PZ3	150 mm	1	NS304-3-150
PZ4	300 mm	1	NS304-4-300

BAM/ZBF/002/21

Gnistfri skruvmejsel för Pozidriv-skruv
ERGO™ i koppar-beryllium



ergo



NSB304

Spår	Längd	Antal	Modell
PZ0	50 mm	1	NSB304-0-50
PZ1	100 mm	1	NSB304-1-100
PZ2	125 mm	1	NSB304-2-125
PZ3	150 mm	1	NSB304-3-150
PZ4	300 mm	1	NSB304-4-300

BAM/ZBF/003/21

Gnistfri insexnyckel i aluminium-brons



NS320

Spår	Antal	Modell
2 mm	1	NS320-2
3 mm	1	NS320-3
4 mm	1	NS320-4
5 mm	1	NS320-5
6 mm	1	NS320-6
7 mm	1	NS320-7
8 mm	1	NS320-8
9 mm	1	NS320-9
10 mm	1	NS320-10

BAM/ZBF/002/21

Gnistfri insexnyckel i koppar-beryllium



NSB320

Spår	Antal	Modell
2 mm	1	NSB320-2
3 mm	1	NSB320-3
4 mm	1	NSB320-4
5 mm	1	NSB320-5
6 mm	1	NSB320-6
7 mm	1	NSB320-7
8 mm	1	NSB320-8
9 mm	1	NSB320-9
10 mm	1	NSB320-10

BAM/ZBF/003/21

TÄNGER

Gnistfri kombinationstång i aluminium-
brons



NS400

Längd	Antal	Modell
155 mm	1	NS400-160
175 mm	1	NS400-180
200 mm	1	NS400-200

BAM/ZBF/002/21

Gnistfri kombinationstång i koppar-
beryllium



NSB400

Längd	Antal	Modell
157 mm	1	NSB400-160
175 mm	1	NSB400-180
200 mm	1	NSB400-200

BAM/ZBF/003/21

Gnistfri sidavbitare i aluminium-brons

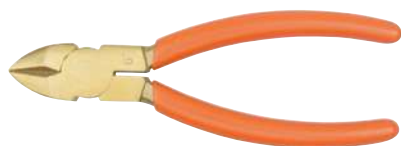

NS402



150 mm	1 NS402-160
200 mm	1 NS402-200

BAM/ZBF/002/21

Gnistfri sidavbitare i koppar-beryllium



NSB402



155 mm	1 NSB402-160
200 mm	1 NSB402-200

BAM/ZBF/003/21

Extra kraftig gnistfri sidavbitare i aluminium-brons



NS403



150 mm	1 NS403-160
180 mm	1 NS403-180

BAM/ZBF/002/21

Gnistfri extra kraftig sidavbitare i koppar-beryllium



NSB403



155 mm	1 NSB403-160
180 mm	1 NSB403-180

BAM/ZBF/003/21

Gnistfri, lång, flackstång i aluminium-brons



NS404



150 mm	1 NS404-160
--------	-------------

BAM/ZBF/002/21

Gnistfri, lång, flackstång i koppar-beryllium



NSB404



155 mm	1 NSB404-160
--------	--------------

BAM/ZBF/003/21

Gnistfri rundstång i aluminium-brons



NS405



160 mm	1 NS405-160
--------	-------------

BAM/ZBF/002/21

Gnistfri rundstång i koppar-beryllium



NSB405



155 mm	1 NSB405-160
--------	--------------

BAM/ZBF/003/21

Gnistfri, lång, spetstång i aluminium-brons



NS406



160 mm	1 NS406-160
180 mm	1 NS406-180
200 mm	1 NS406-200

BAM/ZBF/002/21

Gnistfri, lång, flackstång i koppar-beryllium



NSB406



155 mm	1 NSB406-160
180 mm	1 NSB406-180
200 mm	1 NSB406-200

BAM/ZBF/003/21

Gnistfri skalstång i aluminium-brons



NS407



170 mm	1 NS407-160
--------	-------------

BAM/ZBF/002/21



Gnistfri skaltång i koppar-beryllium



NSB407



170 mm



1 NSB407-160

BAM/ZBF/003/21

Gnistfri polygrip i aluminium-brons



NS408



260 mm

300 mm



1 NS408-250

1 NS408-300

BAM/ZBF/002/21

Gnistfri polygrip i koppar-beryllium



NSB408



255 mm

300 mm



1 NSB408-250

1 NSB408-300

BAM/ZBF/003/21

Gnistfri polygriptång i aluminium-brons



NS412



200 mm



1 NS412-200

BAM/ZBF/002/21

Gnistfri polygriptång i koppar-beryllium



NSB412



200 mm



1 NSB412-200

BAM/ZBF/003/21

Gnistfri gastång i aluminium-brons



NS411



200 mm



1 NS411-200

BAM/ZBF/002/21

Gnistfri gastång i koppar-beryllium



NSB411



205 mm



1 NSB411-200

BAM/ZBF/003/21

Gnistfri hovtång i aluminium-brons



NS413



180 mm

195 mm



1 NS413-180

1 NS413-200

BAM/ZBF/002/21

Gnistfri hovtång i koppar-beryllium



NSB413



185 mm

195 mm



1 NSB413-180

1 NSB413-200

BAM/ZBF/003/21

HAMMARE, BRÄCKJÄRN OCH STÄMJÄRN

Gnistfri slägga med huvud i aluminium-brons och träskaft



NS500



2000 g

2500 g

3000 g

4000 g



1 NS500-2000

1 NS500-2500

1 NS500-3000

1 NS500-4000

BAM/ZBF/002/21

Gnistfri slägga med huvud i koppar-beryllium och träskaft



NSB500



2000 g

2500 g

3000 g

4000 g



1 NSB500-2000

1 NSB500-2500

1 NSB500-3000

1 NSB500-4000

BAM/ZBF/003/21

Gnistfri slägga med huvud i aluminium-brons och tvåkomponentsskaft



NS500-FB

g	Antal	Modell
1000	1	NS500-1000-FB
1500	1	NS500-1500-FB
2000	1	NS500-2000-FB
2500	1	NS500-2500-FB
3000	1	NS500-3000-FB
3500	1	NS500-3500-FB

BAM/ZBF/002/21

Gnistfri slägga med huvud i koppar-beryllium och tvåkomponentsskaft



NSB500-FB

g	Antal	Modell
1000	1	NSB500-1000-FB
1500	1	NSB500-1500-FB
2000	1	NSB500-2000-FB
2500	1	NSB500-2500-FB
3000	1	NSB500-3000-FB
3500	1	NSB500-3500-FB

BAM/ZBF/003/21

Gnistfri slägga med huvud i aluminium-brons och tvåkomponentsskaft



NS502-FB

g	Antal	Modell
450	1	NS502-450-FB
1000	1	NS502-1000-FB
1500	1	NS502-1500-FB
2000	1	NS502-2000-FB
2500	1	NS502-2500-FB
3000	1	NS502-3000-FB
4500	1	NS502-4500-FB
5000	1	NS502-5000-FB

g	Antal	Modell
6800	1	NS502-6800-FB
8000	1	NS502-8000-FB
10000	1	NS502-10000-FB
12000	1	NS502-12000-FB

BAM/ZBF/002/21

Gnistfri slägga med huvud i koppar-beryllium och tvåkomponentsskaft



NSB502-FB

g	Antal	Modell
450	1	NSB502-450-FB
1000	1	NSB502-1000-FB
1500	1	NSB502-1500-FB
2000	1	NSB502-2000-FB
2500	1	NSB502-2500-FB
3000	1	NSB502-3000-FB
4500	1	NSB502-4500-FB
5000	1	NSB502-5000-FB
6800	1	NSB502-6800-FB
8000	1	NSB502-8000-FB
10000	1	NSB502-10000-FB
12000	1	NSB502-12000-FB

BAM/ZBF/003/21

Gnistfri montörshammare med huvud i aluminium-brons och tvåkomponentsskaft



NS504-FB

g	Antal	Modell
100	1	NS504-100-FB
200	1	NS504-200-FB
300	1	NS504-300-FB
500	1	NS504-500-FB
800	1	NS504-800-FB
1000	1	NS504-1000-FB
1500	1	NS504-1500-FB
2000	1	NS504-2000-FB

BAM/ZBF/002/21

Gnistfri montörshammare med huvud i koppar-beryllium och glasfiberskaft



NSB504-FB

g	Antal	Modell
100	1	NSB504-100-FB
200	1	NSB504-200-FB
300	1	NSB504-300-FB
500	1	NSB504-500-FB
800	1	NSB504-800-FB
1000	1	NSB504-1000-FB
1500	1	NSB504-1500-FB
2000	1	NSB504-2000-FB

BAM/ZBF/003/21

Gnistfri kulhammare med huvud i aluminium-brons och träskaft



NS506

g	Antal	Modell
340	1	NS506-300
450	1	NS506-450
670	1	NS506-700
910	1	NS506-900

BAM/ZBF/002/21

Gnistfri kulhammare med huvud i koppar-beryllium och träskaft



NSB506

g	Antal	Modell
300	1	NSB506-300
450	1	NSB506-450
680	1	NSB506-700
910	1	NSB506-900

BAM/ZBF/003/21



Gnistfri kulhammare med huvud i aluminium-brons och tvåkomponentsskaft



NS506-FB

310 g	1	NS506-300-FB
470 g	1	NS506-450-FB
700 g	1	NS506-700-FB
910 g	1	NS506-900-FB

BAM/ZBF/002/21

Gnistfri kulhammare med huvud i koppar-beryllium och tvåkomponentsskaft



NSB506-FB

300 g	1	NSB506-300-FB
450 g	1	NSB506-450-FB
680 g	1	NSB506-700-FB
900 g	1	NSB506-900-FB

BAM/ZBF/003/21

Gnistfri klohammare med huvud i aluminium-brons och tvåkomponentsskaft



NS508-FB

500 g	1	NS508-500-FB
700 g	1	NS508-700-FB

BAM/ZBF/002/21

Gnistfri klohammare med huvud i koppar-beryllium och tvåkomponentsskaft



NSB508-FB

500 g	1	NSB508-500-FB
700 g	1	NSB508-700-FB

BAM/ZBF/003/21

Gnistfri rost- och svetshammare med huvud i aluminium-brons och tvåkomponentsskaft



NS512-FB

230 g	1	NS512-200-FB
400 g	1	NS512-400-FB
640 g	1	NS512-600-FB
970 g	1	NS512-900-FB

BAM/ZBF/002/21

Gnistfri rost- och svetshammare med huvud i koppar-beryllium och tvåkomponentsskaft



NSB512-FB

200 g	1	NSB512-200-FB
400 g	1	NSB512-400-FB
600 g	1	NSB512-600-FB
900 g	1	NSB512-900-FB

BAM/ZBF/003/21

Gnistfria kilar i aluminium-brons



NS600

80 mm	1	NS600-80-13
100 mm	1	NS600-100-50
135 mm	1	NS600-135-50
150 mm	1	NS600-150-25
150 mm	1	NS600-150-30
150 mm	1	NS600-150-40
150 mm	1	NS600-150-50
180 mm	1	NS600-180-13
180 mm	1	NS600-180-32
180 mm	1	NS600-180-50
200 mm	1	NS600-200-20
200 mm	1	NS600-200-30
200 mm	1	NS600-200-40
200 mm	1	NS600-200-50
230 mm	1	NS600-230-40
250 mm	1	NS600-250-40
300 mm	1	NS600-300-50

BAM/ZBF/002/21

Gnistfria kilar i koppar-beryllium



NSB600

80 mm	1	NSB600-80-13
100 mm	1	NSB600-100-50
135 mm	1	NSB600-135-50
150 mm	1	NSB600-150-25
150 mm	1	NSB600-150-30
150 mm	1	NSB600-150-40
150 mm	1	NSB600-150-50
180 mm	1	NSB600-180-13
180 mm	1	NSB600-180-32
180 mm	1	NSB600-180-50
200 mm	1	NSB600-200-20
200 mm	1	NSB600-200-30
200 mm	1	NSB600-200-40
200 mm	1	NSB600-200-50
230 mm	1	NSB600-230-40
250 mm	1	NSB600-250-40
300 mm	1	NSB600-300-50

BAM/ZBF/003/21

Gnistfri kofot i aluminium-brons



NS602

Ø	L		
16 mm	460 mm	1	NS602-460
20 mm	600 mm	1	NS602-600
22 mm	760 mm	1	NS602-760
22 mm	935 mm	1	NS602-900

BAM/ZBF/002/21

Gnistfri kryssmejsel i koppar-beryllium



NSB604

L		
140 mm	1	NSB604-150
200 mm	1	NSB604-200
300 mm	1	NSB604-300

BAM/ZBF/003/21

Gnistfri körnare i aluminium-brons



NS608

L		
100 mm	1	NS608-100

BAM/ZBF/002/21

Gnistfri kofot i koppar-beryllium



NSB6028

Ø	L		
16 mm	460 mm	1	NSB602-460
20 mm	600 mm	1	NSB602-600
22 mm	760 mm	1	NSB602-760
22 mm	920 mm	1	NSB602-900

BAM/ZBF/003/21

Gnistfri huggmejsel i aluminium-brons



NS606

L		
150 mm	1	NS606-150
200 mm	1	NS606-200
250 mm	1	NS606-250
300 mm	1	NS606-300
400 mm	1	NS606-400

BAM/ZBF/002/21

Gnistfritt körnare i koppar-beryllium



NSB608

L		
100 mm	1	NSB608-100

BAM/ZBF/003/21

Gnistfri kryssmejsel i aluminium-brons



NS604

L		
140 mm	1	NS604-150
200 mm	1	NS604-200
300 mm	1	NS604-300

BAM/ZBF/002/21

Gnistfri huggmejsel i koppar-beryllium



NSB606

L		
150 mm	1	NSB606-150
200 mm	1	NSB606-200
250 mm	1	NSB606-250
300 mm	1	NSB606-300
400 mm	1	NSB606-400

BAM/ZBF/003/21

FÄRGSKRAPA

Gnistfri vinklad skrapa i aluminium-brons



NS700

Ø	L		
45 mm	300 mm	1	NS700-300

BAM/ZBF/002/21



Gnistfri vinklad skrapa i koppar-beryllium



NSB700

45 mm	310 mm	1	NSB700-300

BAM/ZBF/003/21

Gnistfri skrapa med långt blad i aluminium-brons



NS704

100 mm	720 mm	1	NS704-225

BAM/ZBF/002/21

Gnistfri flexibel skrapa i koppar-beryllium



NSB706

50 mm	200 mm	1	NSB706-50
80 mm	200 mm	1	NSB706-80

BAM/ZBF/003/21

Gnistfri rak skrapa i aluminium-brons



NS702

30 mm	325 mm	1	NS702-200

BAM/ZBF/002/21

Gnistfri skrapa med långt blad i koppar-beryllium



NSB704

100 mm	720 mm	1	NSB704-225

BAM/ZBF/003/21

Gnistfri trekantskrapa i aluminium-brons



NS708

440 mm		1	NS708-360

BAM/ZBF/002/21

Gnistfri rak skrapa i koppar-beryllium



NSB702

30 mm	325 mm	1	NSB702-200

BAM/ZBF/003/21

Gnistfri rak skrapa i aluminium-brons



NS706

50 mm	200 mm	1	NS706-50
80 mm	200 mm	1	NS706-80

BAM/ZBF/002/21

Gnistfri trekantskrapa i koppar-beryllium



NSB708

450 mm		1	NSB708-360

BAM/ZBF/003/21

Gnistfri trekantskrapa i aluminium-brons



NS710

470 mm	1	NS710-450

BAM/ZBF/002/21

Gnistfri trekantskrapa i koppar-beryllium



NSB710

470 mm	1	NSB710-450

BAM/ZBF/003/21

PLANTERINGSREDSKAP M.M.

Gnistfria korpar i aluminium-brons



NS800

910 mm	1	NS800-1100
910 mm	1	NS800-1700
965 mm	1	NS800-2000

BAM/ZBF/002/21

Gnistfri korp i koppar-beryllium



NSB800

910 mm	2000 g	1	NSB800-1100
910 mm	2800 g	1	NSB800-1700
910 mm	3200 g	1	NSB800-2000

BAM/ZBF/003/21

Gnistfri skyffel i aluminium-brons



NS802

1370 mm	1	NS802-290

BAM/ZBF/002/21

Gnistfri skyffel i koppar-beryllium



NSB802

1450 mm	1	NSB802-290

BAM/ZBF/003/21

Gnistfri handborste i mässing



NS804

290 mm	1	NS804-290

BAM/ZBF/002/21

AVDRAGARE OCH BRÄCKJÄRN

Gnistfri avdragare med 3 vändbara armar i aluminium-brons



NS810

50-100 mm	105 mm	1	NS810-100
60-150 mm	175 mm	1	NS810-150
70-200 mm	250 mm	1	NS810-200
80-350 mm	320 mm	1	NS810-350

BAM/ZBF/002/21

Gnistfri avdragare med 3 vändbara armar i koppar-beryllium



NSB810

50-100 mm	105 mm	1	NSB810-100
60-150 mm	175 mm	1	NSB810-150
70-200 mm	250 mm	1	NSB810-200
80-350 mm	320 mm	1	NSB810-350

BAM/ZBF/003/21



MOMENTVERKTYG

Gnistfri mekanisk justerbar momentklicknyckel med fönsterskala och fast spärrhuvud i aluminium-brons



NS041

Size	Range (Nm)	Quantity	Part Number
1/4"	5-25 Nm	1	NS041-8-25
3/8"	10-50 Nm	1	NS041-12-50
1/2"	20-100 Nm	1	NS041-16-100
1/2"	40-200 Nm	1	NS041-16-200
1/2"	60-260 Nm	1	NS041-16-260
3/4"	150-670 Nm	1	NS041-24-670
1"	200-900 Nm	1	NS041-32-900

BAM/ZBF/002/21

Gnistfri mekanisk justerbar momentklicknyckel med fönsterskala och fast spärrhuvud i koppar-beryllium



NSB041

Size	Range (Nm)	Quantity	Part Number
1/4"	5-25 Nm	1	NSB041-8-25
3/8"	10-50 Nm	1	NSB041-12-50
1/2"	20-100 Nm	1	NSB041-16-100
1/2"	40-200 Nm	1	NSB041-16-200
1/2"	60-260 Nm	1	NSB041-16-260
3/4"	150-670 Nm	1	NSB041-24-670
1"	200-900 Nm	1	NSB041-32-900

BAM/ZBF/003/21



Verktyg i rostfritt stål



VERKTYGSVAGN

26" verktygsvagn i rostfritt stål med 7 lådor



1470K7SS



956 x 500 x 762 mm

1 1470K7SS

40" verktygsvagn i rostfritt stål med 7 lådor



1475KXL7SS



986 x 501 x 1100 mm

1 1475KXL7SS

DRAGVERKTYG

Skiftnyckel i rostfritt stål



SS001



100mm/4"	13 mm	1	SS001-100
150mm/6"	18 mm	1	SS001-150
200mm/8"	24 mm	1	SS001-200
250mm/10"	30 mm	1	SS001-250
300mm/12"	36 mm	1	SS001-300
375mm/15"	46 mm	1	SS001-375
450mm/18"	55 mm	1	SS001-450
600mm/24"	60 mm	1	SS001-600

U-ringnyckel i rostfritt stål, metrisk



SS002



6 mm	1	SS002-6
8 mm	1	SS002-8
10 mm	1	SS002-10
11 mm	1	SS002-11
12 mm	1	SS002-12
13 mm	1	SS002-13
14 mm	1	SS002-14
15 mm	1	SS002-15
16 mm	1	SS002-16
17 mm	1	SS002-17
19 mm	1	SS002-19
21 mm	1	SS002-21
22 mm	1	SS002-22
24 mm	1	SS002-24
27 mm	1	SS002-27
32 mm	1	SS002-32

Sats med bockade u-ringnycklar i rostfritt stål, metrisk dimensioner – 6 delar



SS002-6-2



6	710 g	1	SS002-6-2
---	-------	---	-----------

SS002-8, SS002-10, SS002-12, SS002-14, SS002-17, SS002-19

Sats med u-ringnycklar i rostfritt stål, metrisk dimensioner – 9 delar



SS002-9-2



9	924 g	1	SS002-9-2
---	-------	---	-----------

SS002-8, SS002-10, SS002-11, SS002-12, SS002-13, SS002-14, SS002-15, SS002-17, SS002-19



U-ringnyckel i rostfritt stål, tum-skala



SS003



1/4 in	105 mm	1	SS003-8
5/16 in	120 mm	1	SS003-10
11/32 in	135 mm	1	SS003-11
3/8 in	135 mm	1	SS003-12
7/16 in	150 mm	1	SS003-14
1/2 in	175 mm	1	SS003-16
9/16 in	175 mm	1	SS003-18
5/8 in	195 mm	1	SS003-20
11/16 in	195 mm	1	SS003-22
3/4 in	215 mm	1	SS003-24
25/32 in	215 mm	1	SS003-25
13/16 in	245 mm	1	SS003-26
7/8 in	245 mm	1	SS003-28
15/16 in	265 mm	1	SS003-30

Dubbel ringnyckel i rostfritt stål, metrisk



SS011



5.5*7 mm	180 mm	1	SS011-0507
6*7 mm	180 mm	1	SS011-0607
8*9 mm	190 mm	1	SS011-0809
8*10 mm	190 mm	1	SS011-0810
9*11 mm	215 mm	1	SS011-0911
10*12 mm	215 mm	1	SS011-1012
12*14 mm	225 mm	1	SS011-1214
14*17 mm	255 mm	1	SS011-1417
16*18 mm	280 mm	1	SS011-1618
17*19 mm	280 mm	1	SS011-1719
17*22 mm	300 mm	1	SS011-1722
22*24 mm	330 mm	1	SS011-2224
24*27 mm	340 mm	1	SS011-2427
24*30 mm	350 mm	1	SS011-2430
30*32 mm	370 mm	1	SS011-3032

Sats med bockade dubbla ringnycklar i rostfritt stål, mm. 9 delar



SS011-9-3

g	SS011-9-3
2470 g	1

SS011-0810, SS011-1012, SS011-1214, SS011-1417, SS011-1719, SS011-1722, SS011-2224, SS011-2427, SS011-3032

Sats med bockade dubbla ringnycklar i rostfritt stål, mm. 11 delar



SS011-11-3

g	SS011-11-3
3100 g	1

SS011-0810, SS011-0911, SS011-1012, SS011-1214, SS011-1417, SS011-1719, SS011-1722, SS011-2224, SS011-2427, SS011-2430, SS011-3032

HYLSOR OCH SPÄRRHANDTAG

1/4" hylsnyckel med fyrkantfäste och metrisk sexkantprofil



SS210

Ø	L	SS210-4
4 mm	25 mm	1
4.5 mm	25 mm	1

Ø	L	SS210-5
5 mm	25 mm	1
5.5 mm	25 mm	1
6 mm	25 mm	1
7 mm	25 mm	1
8 mm	25 mm	1
9 mm	25 mm	1
10 mm	25 mm	1
11 mm	25 mm	1
12 mm	26 mm	1
13 mm	26 mm	1
14 mm	26 mm	1

1/2" hylsa med fyrkantfäste och metrisk sexkantprofil



SS220

Ø	L	SS220-8
8 mm	40 mm	1
9 mm	40 mm	1
10 mm	40 mm	1
11 mm	40 mm	1
12 mm	40 mm	1
13 mm	40 mm	1
14 mm	40 mm	1
15 mm	40 mm	1
16 mm	40 mm	1
17 mm	40 mm	1
18 mm	42 mm	1
19 mm	42 mm	1
20 mm	42 mm	1
21 mm	43 mm	1
22 mm	43 mm	1
23 mm	43 mm	1
24 mm	43 mm	1
25 mm	43 mm	1
26 mm	43 mm	1
27 mm	46 mm	1
28 mm	46 mm	1
29 mm	46 mm	1
30 mm	46 mm	1
31 mm	46 mm	1
32 mm	46 mm	1

3/4" hylsnyckel med fyrkantfäste och metrisk sexkantprofil



SS224

Ø	L	SS224-17
17 mm	50 mm	1
19 mm	50 mm	1
22 mm	55 mm	1
24 mm	55 mm	1
27 mm	55 mm	1
30 mm	60 mm	1
32 mm	60 mm	1
34 mm	60 mm	1
36 mm	60 mm	1
41 mm	65 mm	1
46 mm	65 mm	1
50 mm	70 mm	1
55 mm	75 mm	1
60 mm	75 mm	1
65 mm	80 mm	1

Förlängare i rostfritt stål



SS234

L	SS234-16-100
100 mm	1
200 mm	1
250 mm	1
100 mm	1
200 mm	1
250 mm	1

Universalknut i rostfritt stål



SS236

L	SS236-08-80
56 mm	1
80 mm	1
110 mm	1



T-stångshandtag i rostfritt stål



SS238

250 mm	1 SS238-08-250
250 mm	1 SS238-16-250
350 mm	1 SS238-24-350

Svänghandtag i rostfritt stål



SS243

300 mm	1 SS243-08
390 mm	1 SS243-16
450 mm	1 SS243-24

Spärrhandtag i rostfritt stål



SS242

200 mm	1 SS242-08-200
245 mm	1 SS242-16-245
320 mm	1 SS242-24-320

SKRUVMEJSLAR

ERGO™ skruvmejsel med trekomponentshandtag, med rak spets för spårskruv, 0,5 mm–1,2 mm



BE-8020i-BE-8252i

3.0 mm	60 mm	5	BE-8020i
3.5 mm	75 mm	5	BE-8030i

4.0 mm	100 mm	5	BE-8040i
5.5 mm	125 mm	5	BE-8241i
6.5 mm	150 mm	5	BE-8252i

ERGO™ skruvmejslar i rostfritt stål med trekomponentshandtag, för Phillips®-skruv PH0-PH4



BE-8600i-BE-8623i

PH 0	60 mm	5	BE-8600i
PH 1	75 mm	5	BE-8610i
PH 2	100 mm	5	BE-8620i
PH 3	150 mm	5	BE-8623i

ERGO™ skruvmejsel i rostfritt stål med trekomponentshandtag, för Pozidriv®-skruv PZ0-PZ4



BE-8800i-BE-8823i

PZ 0	60 mm	5	BE-8800i
PZ 1	75 mm	5	BE-8810i
PZ 2	100 mm	5	BE-8820i
PZ 3	150 mm	5	BE-8823i

ERGO™ skruvmejsel i rostfritt stål med trekomponentshandtag, för Torx®-skruv T10-T25



BE-8910i-BE-8925i

T 10	75 mm	5	BE-8910i
T 15	100 mm	5	BE-8915i
T 20	100 mm	5	BE-8920i
T 25	125 mm	5	BE-8925i

ERGO™ sats med rostfria skruvmejslar för spår- och Phillips®-skruv – 6 delar



BE-9881i

6	1	BE-9881i

BE-8020i, BE-8040i, BE-8241i, BE-8252i

BE-8610i, BE-8620i

Sats med skruvmejslar ERGO™ för spår-/Pozidriv®-skruv med rostfria klingor – 6 st



BE-9882i

6	1	BE-9882i

BE-8020i, BE-8040i, BE-8241i, BE-8252i

BE-8810i, BE-8820i

VINKELSKRUVMEJSLAR

Sats med långa insexnycklar med kula, tum-dimensioner – 13 delar



BE-9785i

13	0.05; 1/16; 5/64; 3/32; 7/64; 1/8; 9/64; 5/32; 3/16; 7/32; 1/4; 5/16; 3/8; in	1	BE-9785i

0.05; 1/16; 5/64; 3/32; 7/64; 1/8; 9/64; 5/32; 3/16; 7/32; 1/4; 5/16; 3/8;

Sats med långa metrisk insexnycklar med kula



SS324

1,5 mm	2	SS324-1.5
2 mm	2	SS324-2
2,5 mm	2	SS324-2.5
3 mm	1	SS324-3
4 mm	1	SS324-4
5 mm	1	SS324-5
6 mm	1	SS324-6
8 mm	1	SS324-8
10 mm	1	SS324-10

Sats med långa metrisk insexnycklar med kula – 9 delar



BE-9770i

9	1.5; 2; 2.5; 3; 4; 5; 6; 8; 10 mm	20	BE-9770i
---	-----------------------------------	----	----------

1.5; 2; 2.5; 3; 4; 5; 6; 8; 10

SS324-1.5, SS324-2, SS324-2.5, SS324-3, SS324-4, SS324-5, SS324-6, SS324-8, SS324-10

Sats med långa insexnycklar med kula, rostfritt stål, tum-dimensioner



SS325

5/64" in	2	SS325-2.5
7/64" in	2	SS325-3.5
1/8" in	1	SS325-4
9/64" in	1	SS325-4.5
5/32" in	1	SS325-5
3/16" in	1	SS325-6
7/32" in	1	SS325-7
1/4" in	1	SS325-8
5/16" in	1	SS325-10
3/8" in	1	SS325-12
3/32" in	2	SS325-3

Sats med långa insexnycklar med kula, tum-dimensioner – 13 delar



BE-9786i

13	0.05; 1/16; 5/64; 3/32; 7/64; 1/8; 9/64; 5/32; 3/16; 7/32; 1/4; 5/16; 3/8; in	1	BE-9786i
----	---	---	----------

0.05; 1/16; 5/64; 3/32; 7/64; 1/8; 9/64; 5/32; 3/16; 7/32; 1/4; 5/16; 3/8;

SS325-2.5, SS325-3, SS325-3.5, SS325-4, SS325-4.5, SS325-5, SS325-6, SS325-7, SS325-8, SS325-10, SS325-12

BITS

1/4" torsionsbits i rostfritt stål för Phillips®-skruvar, 25 mm



65I/PH

10	1	1	65I/PH1
10	2	1	65I/PH2
10	3	1	65I/PH3

1/4" torsionsbits i rostfritt stål för Pozidriv®-skruvar, 25 mm



65I/PZ

10	1	1	65I/PZ1
10	2	1	65I/PZ2
10	3	1	65I/PZ3

1/4" torsionsbits i rostfritt stål för Torx®-skruv, 25 mm



65I/T

5	T15	1	65I/T15
5	T40	1	65I/T40

1/4" universalbitshållare med låsring för sexkantsbits, längd 75 mm



KSR753

1	1/4 in	1	KSR753-1P
5	1/4 in	1	KSR753

1/4" bitsats i rostfritt stål för Phillips®-/Pozidriv-/Torx®-skruv – 7 delar



65I/7

22 x 65 x 75 mm	1	65I/7-1
-----------------	---	---------

+ 1 bilholder

65I/PH2	
65I/PZ2	
65I/T15, 65I/T20, 65I/T25, 65I/T30	



TÄNGER

Kombinationstång i rostfritt stål med PVC-överdragna handtag



SS400



155 mm	1	SS400-160
175 mm	1	SS400-180
200 mm	1	SS400-200

Sidavbitare i rostfritt stål med PVC-överdragna handtag



SS402



150 mm	1	SS402-160
195 mm	1	SS402-200

Polygriptång i rostfritt stål, 2 lägen, PVC-överdragna handtag



SS412



200 mm	1	SS412-200
--------	---	-----------

Spetstång i rostfritt stål med PVC-överdragna handtag



SS406

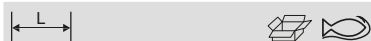

150 mm	1	SS406-160
175 mm	1	SS406-200

Polygriptång i rostfritt stål med PVC-överdragna handtag



SS410



250 mm	1	SS410-250
300 mm	1	SS410-300

Låstång i rostfritt stål



SS415

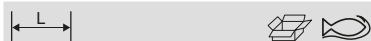

255 mm	1	SS415-225
--------	---	-----------

HAMMARE

Kulhammare i rostfritt stål med glasfiberskaft



SS506



200 g	1	SS506-200-FB
300 g	1	SS506-300-FB

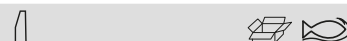

450 g	1	SS506-500-FB
680 g	1	SS506-700-FB
900 g	1	SS506-900-FB
1100 g	1	SS506-1100-FB

Slägga i rostfritt stål med glasfiberskaft



SS502



1000 g	1	SS502-1000-FB
1500 g	1	SS502-1500-FB
2000 g	1	SS502-2000-FB
2500 g	1	SS502-2500-FB
3000 g	1	SS502-3000-FB
3600 g	1	SS502-3600-FB

DORN OCH HUGGMEJSLAR

Bräckjärn i rostfritt stål, avsmalnande



SS603



500 mm	1	SS603-15-500
500 mm	1	SS603-19-500
500 mm	1	SS603-20-500
500 mm	1	SS603-23-500
800 mm	1	SS603-23-800
600 mm	1	SS603-25-600
1000 mm	1	SS603-30-1000

Huggmejsel 55°, i rostfritt stål, oval form



SS610



160 mm	1	SS610-16-160
200 mm	1	SS610-18-200
300 mm	1	SS610-24-300
400 mm	1	SS610-25-400
500 mm	1	SS610-30-500

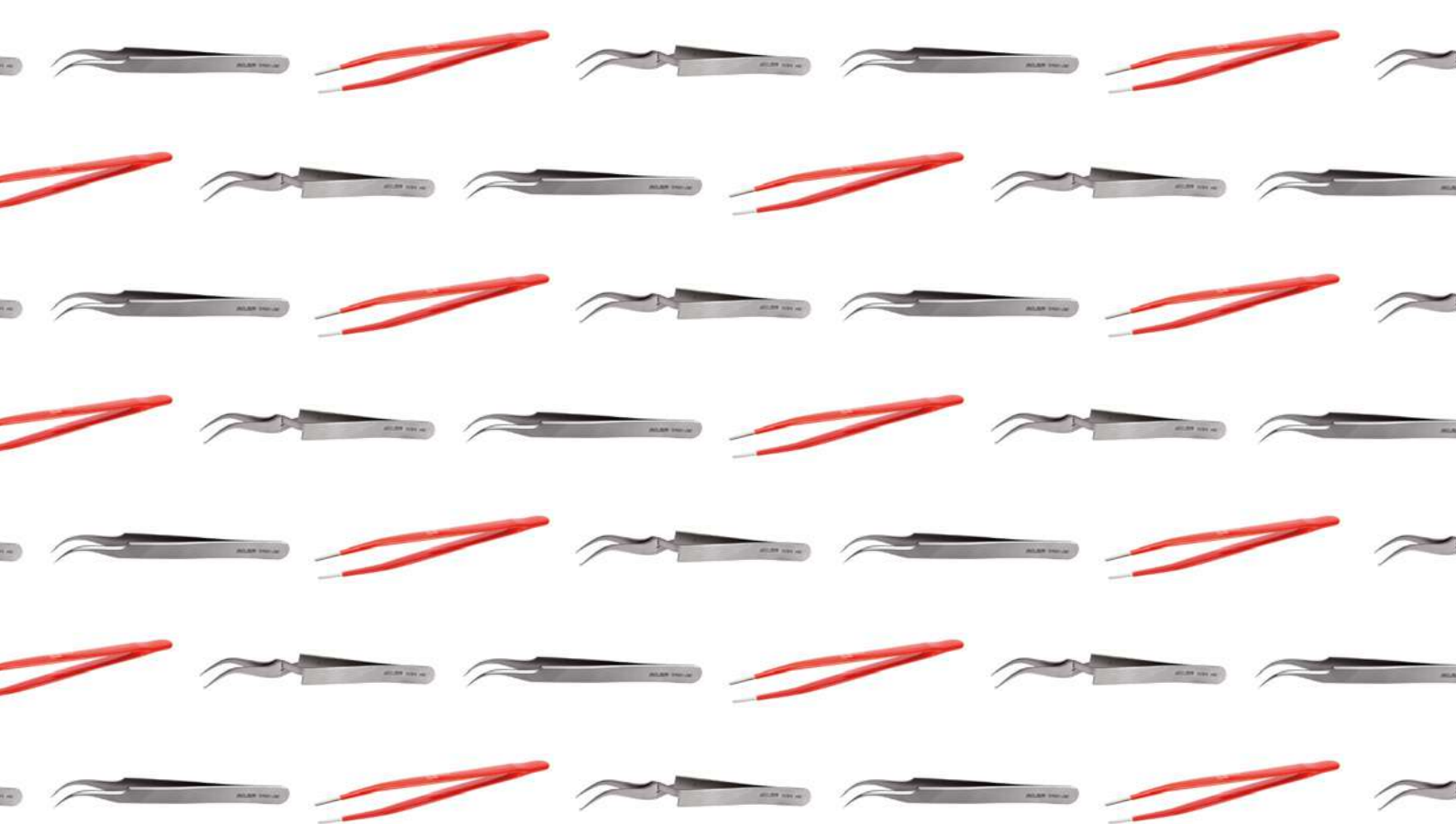

Pincetter och specialverktyg för elektronik



PINCETTER

Pincett med tandade spetsar



5468



112 mm



5 5468-112

Universalpincett, höglanspolerad med PVC-överdrag, 127 mm



5469



127 mm
127 mm
127 mm



5 5469-127
5 5469 R
5 5469 I

Universalpincett med höglans eller PVC-överdrag-120 mm



5469B



120 mm
120 mm



5 5469 B
5 5469 BI

Universalpincett, polerad och förnicklad



5479



130 mm



5 5479-130

Universalpincett, polerad och förnicklad eller polerad, PVC-belagd



5471F



120 mm
145 mm
200 mm
250 mm
300 mm
120 mm
200 mm
120 mm
145 mm



5 5471 F-120
5 5471 F-145
5 5471 F-200
5 5471 F-250
5 5471 F-300
5 5471 FI-120
5 5471 FI-200
5 5471 FR-120
5 5471 FR-145

Universalpincett polerad eller förnicklad och polerad



5475R/5475K



150 mm
100 mm



5 5475 R
5 5475 K

Universalpincett polerad och förnicklad, polerad, PVC-belagd



5516



150 mm
150 mm



5 5516
5 5516 I

Ikke magnetisk pincett i titan, för fina och ytterst fina detaljarbeten-110 mm



5465AMT



110 mm



5 5465 AMT

Ikke magnetisk pincett i rostfri stål, för fina och ytterst fina detaljarbeten-130 mm



5469AMI



130 mm



1 5469 AMI

Spetsig universalpincett, polerad och förnicklad/polerad/PVC-belagd



5517



155 mm
155 mm



5 5517
5 5517 I

Universalpincett med omvänd funktion, polerad och förnicklad yta



5518



155 mm



5 5518

SMD-pincett för SOT-komponenter



5540AM



120 mm



5 5540 AM

SMD-pincett för placering och lödning av 1 mm-komponenter



5546AM



120 mm



5 5546 AM

Elektronikpincett för upplockning av liggande komponenter



5489AM



115 mm



5 5489 AM

SMD-pincett för arbete med SOT-komponenter, vertikalt



5541AM



120 mm



5 5541 AM

SMD-pincett för placering och lödning av 1 mm-komponenter vid 45° vinkel



5547AM



120 mm



5 5547 AM

Elektronikpincett för arbeten i trånga utrymmen



5490AM



115 mm



5 5490 AM

SMD-pincett för hantering och placering av 2 och 3 ledare, SOT-komponenter vid 45° vinkel



5544AM



115 mm



5 5544 AM

SMD-pincett för placering av 5 mm chipkondensatorer



5549AM



120 mm



5 5549 AM

Hållande pincett för in- och urtagning av detaljer mellan olika kretskortsnivåer, med 6 mm spets



5573



145 mm



5 5573-145

SMD pincett för placering detaljer med plan bas i 60° vinkel



5545AM



120 mm



5 5545 AM

Elektronikpincett för små komponenter



5488AM



115 mm



5 5488 AM

Hållande pincett för in- och urtagning av komponenter, med 4 mm spets



5578



122 mm



5 5578-115



Hållande pincett för in- och uttagning av komponenter



5579



115 mm 5 5579-115

SMD-pincett för placering av 5 mm chipkondensatorer vid 60° vinkel



5588AM



120 mm 5 5588 AM

SMD-pincett med skålförmade spetsar, böjda 30°



5589AM



120 mm 5 5589 AM

SMD pincett för vertikal placering av cylindriska detaljer Ø1 mm eller mer



5590AM



120 mm 5 5590 AM

Sats med rostfria SMD-pincetter, 5 st



5568/5



100 g 1 5568/5

5489 AM	
5583 AM	
5589 AM	
5584 AM	
5546 AM	

Rak, polerad urmakarpincett 120 mm



5463



120 mm 5 5463-120
120 mm 5 5463 R

Juvelerarpincett med polerad och förnicklad eller PVC-överdragen yta



5470



120 mm 5 5470-120
160 mm 5 5470 I-160

Värmeabsorberande pincett för lödning av halvledare



5577



145 mm 5 5577-145

Rak, polerad urmakarpincett-110 mm



5464



110 mm 5 5464-105

Rak, polerad urmakarpincett-105 mm



5465



105 mm 5 5465 R

Avbitarpincett för koppartråd



5493



115 mm 5 5493-115

Lödpincett med skyddsgrepp



5476H



160 mm



5 5476 H

Avlödningspincett för borttagning av hårt fastsatta runda eller kubiska komponenter



5574



145 mm



5 5574-145

LÖDVERKTYG

Lödpistol, snabbuppvärmd och dubbelisolerad



3250



100 W

400 °C



1 325001000
1 3250010SH

3250010SH: Spare tip

Robust lödkolv med EU-kontakt och lödställ 30 W/40 W/80 W



322500



30 W

370 °C



1 322500300

40 W

375 °C

1 322500500

80 W

380 °C

1 322500800

Elektronisk lödkolv med jordad kontakt 18 W/25 W



32600



18 W

390 °C



1 326000200

25 W

420 °C

1 326000300

Lödkolv med justerbar temperatur, jordad kontakt och lödställ



3270



50 W

200-500 °C



1 327020500

Elektronisk lödkolv med jordad kontakt 30 W/40 W



329500



30 W

380 °C



1 329500300

40 W

420 °C

1 329500400

Robust lödkolv med jordad kontakt och lödställ 50 W/80 W



329600



50 W

400 °C



1 329600500

80 W

410 °C

1 329600800

Spetsar för extra kraftig lödkolv, raka och vinklade



3225



1.5 x 2.5 mm



1 322510300

1.5 x 2.5 mm

1 322510400

2 x 3 mm

1 322510500

2 x 3 mm

1 322510600

2.5 x 5 mm

1 322510700

2.5 x 5 mm

1 322510800

Spetsar för elektroniska lödkolvar



326010



5 g



1 326010200

5 g

1 326020200

5 g

1 326030200



Spetsar för lödkolv med justerbar temperatur, 3270



327020500-SH

Spets	Antal	Varuslag
0,5mm	1	327020500-SH1
2mm	1	327020500-SH2
3mm	1	327020500-SH3
4mm	1	327020500-SH4

Blyfritt lödtenn 0,8 mm



3290

Längd	Antal	Varuslag
2000 mm	1	329000330
4000 mm	1	329000500

Sats med krokar 105 mm, 6 st



5419/6T

Storlek	Antal	Varuslag
5 x 78 x 110 mm	1	5419/6T

SPECIALVERKTYG FÖR FINMEKANIK

Spetsar för elektroniska lödkolvar med mejselform och pennform



3295

Antal	Varuslag
5 g	1 329500350
5 g	1 329500450

Sats med minisylar och krokverktyg, 150-250 mm



2633/

Storlek	Antal	Varuslag
17 x 80 x 150 mm	12	2633/S4
12 x 12 x 275 mm	12	2633L/S4

ERGO™ O-ringsverktyg för avlödning



ergo



BE-3529

Längd	Antal	Varuslag
197 mm	5	BE-3529

Spetsar för extra kraftig lödkolv



3296

Antal	Varuslag
10 g	1 329600100
10 g	1 329600200

Fjäderkrok, dubbel med räfflat sexkantshandtag



5418

Längd	Antal	Varuslag
145 mm	1	5418

Justerskruvmejsel med styrhylsa och plasthandtag



5550

Längd	Antal	Varuslag
140 mm	10	5550-3.2
140 mm	10	5550-4.5

Avstämnings- och trimverktyg 180 mm-220 mm



5551-5554

L		
220 mm	1	5551
205 mm	1	5552
195 mm	1	5553
180 mm	1	5554

Sats med avstämnings- och trimverktyg, med tryckknapp



5600/4

g		
75 g	1	5600/4

5551, 5552, 5553, 5554

Avisoleringspincett, lackerad, med plastgrepp



2530-32/2530-40

L		
130 mm	5	2530-40

Packningskrapa med plasthandtag



2487

L		
210 mm	12	2487

Trekantskavstål med förnicklat handtag



3524

g		
24 g	1	3524
5 g	1	3524L-K

Trekantskavstål med plasthandtag



3525HB

L		
168 mm	5	3525HB

Förstoringsglas 90 mm x 30 mm



3046-OP

L		
105 mm	12	3046-OP



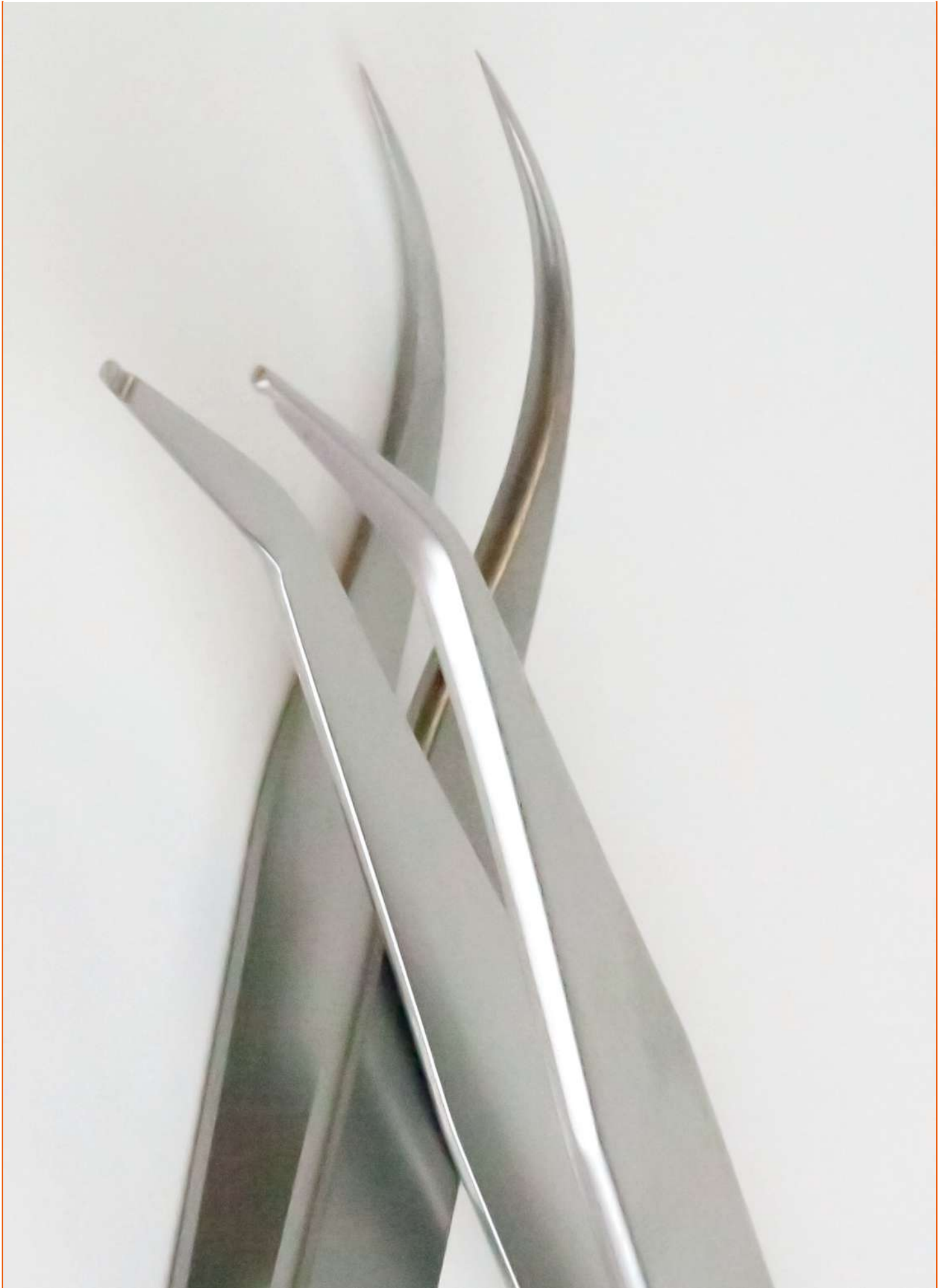

BAHCO



Mätning och märkning



MÅTTBAND

Dubbelsidiga måttband med gummigrepp



MTS

L	mm	Q	Q
5 m	25 mm	6	MTS-5-25
5 m	25 mm	6	MTS-5-25-E
8 m	25 mm	6	MTS-8-25
8 m	25 mm	6	MTS-8-25-E

Korta måttband med gummigrepp



MTB

L	mm	Q	Q
3 m	16 mm	6	MTB-3-16
3 m	16 mm	6	MTB-3-16-M
3 m	16 mm	6	MTB-3-16-M-E
5 m	25 mm	6	MTB-5-25
5 m	25 mm	6	MTB-5-25-M
5 m	25 mm	6	MTB-5-25-M-E
8 m	25 mm	6	MTB-8-25
8 m	25 mm	6	MTB-8-25-M
8 m	25 mm	6	MTB-8-25-M-E

Måttband med gummigrepp, klass I



MTB_C1

L	mm	Q	Q
5 m	25 mm	6	MTB-5-25-C1

Korta måttband med manuell vridlåsknapp



MTG

L	mm	Q	Q
3 m	16 mm	12	MTG-3-16
3 m	16 mm	12	MTG-3-16-E
5 m	19 mm	12	MTG-5-19
5 m	19 mm	12	MTG-5-19-E
8 m	25 mm	4	MTG-8-25
8 m	25 mm	4	MTG-8-25-E

Måttband med grepp av ABS-plast och noggrannhet klass I



MTC_C1

L	mm	Q	Q
3 m	13 mm	6	MTC-3-13-C1
5 m	16 mm	6	MTC-5-16-C1

Måttband med hus av ABS-plast, noggrannhet klass II



MTC_C2

L	mm	Q	Q
3 m	13 mm	6	MTC-3-13
5 m	16 mm	6	MTC-5-16

Måttband, 3 m



MT-TS-3

L	mm	Q	Q
3 m	13 mm	12	MT-TS-3

Kort måttband av stål



1162N

L	mm	Q	Q
3 m	13 mm	1	1162N-1/2

Bänkmåttband av självhäftande stål



BT

L	mm	Q	Q
3 m	13 mm	12	BTR-3-13
6 m	13 mm	12	BTR-6-13
3 m	13 mm	12	BTL-3-13
6 m	13 mm	12	BTL-6-13

Långa måttband av stål



LTG

L	mm	Stapel	Fisk
10 m	10 mm	6	LTG-10
20 m	10 mm	6	LTG-20
30 m	10 mm	6	LTG-30

Långa måttband med nylonöverdraget band



LTB

L	mm	Stapel	Fisk
10 m	13 mm	6	LTB-10
20 m	13 mm	6	LTB-20
30 m	13 mm	6	LTB-30

Långa måttband av stål med öppen hållare



LT-STEEL

L	mm	Stapel	Fisk
30 m	13 mm	5	LT-STEEL-30
50 m	13 mm	5	LT-STEEL-50

Långa måttband med nylonöverdraget band och öppen hållare



LTS

L	mm	Stapel	Fisk
30 m	13 mm	5	LTS-30
30 m	13 mm	5	LTS-30-E
50 m	13 mm	5	LTS-50
50 m	13 mm	5	LTS-50-E
100 m	13 mm	5	LTS-100
100 m	13 mm	5	LTS-100-E

MÄTHJUL

Metrisk gummiklädda mätjul 150 mm



MW-150

L	Stapel	Fisk
150 mm	2	MW-150

Metriskt mätjul, gummibelagd, 250 mm



MW-250

L	Stapel	Fisk
250 mm	2	MW-250

VATTENPASS

Vattenpass av kraftig aluminium



466

L	Stapel	Fisk
400 mm	4	466-400
400 mm	4	466-400-M
600 mm	4	466-600
600 mm	4	466-600-M
800 mm	4	466-800
800 mm	4	466-800-M
1000 mm	4	466-1000
1000 mm	4	466-1000-M
1200 mm	4	466-1200
1200 mm	4	466-1200-M
1800 mm	4	466-1800
2000 mm	4	466-2000

Rektangulära vattenpass av aluminium



426

L	Bredd	Stapel	Fisk
400 mm	49x22 mm	1	426-400
600 mm	49x22 mm	1	426-600
800 mm	49x22 mm	1	426-800
1000 mm	49x22 mm	1	426-1000
1200 mm	49x22 mm	1	426-1200

426-400 och 426-600 med 2 libeller. 426-600-3 och längre vattenpass, med 3 libeller



Lätt vattenpass av aluminium



416

416	416	416
400 mm	10	416-400
600 mm	10	416-600
800 mm	10	416-800
1000 mm	10	416-1000
1200 mm	10	416-1200
1500 mm	10	416-1500
1800 mm	10	416-1800
2000 mm	10	416-2000

Lätt vattenpass av solitt formgjutet aluminium



405L

405L	405L	405L
400 mm	10	405L-400
600 mm	10	405L-600

Lätt magnetiskt vattenpass i solitt formgjutet aluminium



405L_M

405L_M	405L_M	405L_M
400 mm	5	405L-400-M
600 mm	5	405L-600-M

Vattenpass av formgjutet aluminium



405

405	405	405
400 mm	5	405-400
600 mm	5	405-600
800 mm	10	405-800
1000 mm	5	405-1000

Magnetiskt vattenpass av kraftigt aluminium



405_M

405_M	405_M	405_M
400 mm	5	405-400-M
600 mm	5	405-600-M
800 mm	5	405-800-M
1000 mm	5	405-1000-M

Vattenpass av kraftigt aluminium, magnetiskt



406_M

406_M	406_M	406_M	406_M
300 mm	1	5	406-300-M
400 mm	1	5	406-400-M
500 mm	1	5	406-500-M
600 mm	1	5	406-600-M

Vattenpass av polystyren



406P

406P	406P	406P	406P
400 mm		10	406P-400
600 mm		10	406P-600

Sats med vattenpass 600/1200/1800 mm-3 st/väska



416-SET+BAG

416-SET+BAG	416-SET+BAG	416-SET+BAG
3		1 416-SET+BAG

416-SET-1

4750-LV-1

BAHCO



Vattenpass, sats med 3 st, 600/1 200/1 800 mm



416-SET-1



3 5 416-SET-1

416-600, 416-1200, 416-1800



Vattenpass, sats med 3 st, 600/1 200/2 000 mm



416-SET-2



3 5 416-SET-2

416-600, 416-1200, 416-2000



Magnetiska Torpedo vattenpass i plast



406T-225



228 mm 10 406T-225

DISP är en bordsdisplay med 12 vattenpass

Torpedo vattenpass i aluminium



426TOR9



230 mm 10 426TOR9

Torpedo vattenpass i aluminium



466-250



250 mm 10 466-250

Aluminiumvattenpass 75 mm



466-LINE



75 mm 12 466-LINE

Vattenpass med slät yta för både vertikal och horisontell användning



Magnetiska vattenpass för t ex stolpar



466-POST



120 x 75 x 80 mm 6 466-POST

Vattenpass, rätskiva, av aluminium



486



1800 mm 5 486-1800
2000 mm 5 486-2000
2400 mm 5 486-2400

Aluminiumvattenpass, rätskiva, utan grepphål



486-xxxWH



1800 mm 5 486-1800WH
2000 mm 5 486-2000WH
2400 mm 5 486-2400WH

Precisionsvattenpass med dubbel t-profil



496



1500 mm 5 496-1500
1800 mm 5 496-1800



Reservlibell för vattenpass 496



496-SPARE

496-1500, 496-1800	1	496-SPARE

MÄRKNING

Snörslå 5 x återspolning



CL-1441

185 mm	36	CL-1441

Snörslå 1 x återspolning



CL-1331

185 mm	48	CL-1331

Snörslå 3 x återspolning



CL-1221

130 mm	6	CL-1221

Märkkrita 227 g/flaska



CHALK

227 g	6	CHALK-BLUE
227 g	6	CHALK-WHITE
227 g	6	CHALK-RED
227 g	6	CHALK-YELLOW

Sats med snörslå 3 x återspolning-3 st.



CL-1221-SET

180 g	4	CL-1221-SET

CHALK-BLUE

466-LINE

CL-1221



Lod med 5 m lina



PBS

5 m	6	PBS-700

Lod med spets av härdat stål



PBB

185 mm	227 g	8	PBB-8

Snickarpennor hårdhet HB-25 st./låda



P-HB

175 mm	25	25	P-HB

FSC certifikat: QMI-COC-001417 File No: 1627439

Snickarpennor hårdhet HB-200 st. i display



PENCIL-200

180 mm	200	1	PENCIL-200-DISP

Stiftpenna med hårdhet HB



P-MEC

150 mm	1	24	P-MEC
100 mm	5	12	P-MEC-LEAD

Ritsar med utbytbar spets av hårdmetall



1179-SCRIBE

150 mm	5	1179-SCRIBE	
	1	1179-TIPS	

Ritsar av hårdmetall



1178-SCRIBE

150 mm	5	1178-SCRIBE	

Rits av högkvalitativ stålgering



1177-SCRIBE

230 mm	5	1177-SCRIBE	

LINJALER

Tumstockar i trä, 1 m, 5 sektioner



WR1

1 m	17 mm	50	WR1
1 m	17 mm	50	WR1-MM

Tumstockar i trä, 2 m, 10 sektioner



WR2

2 m	17 mm	25	WR2
2 m	17 mm	25	WR2-MM

Tumstockar i trä, 2 m, 12 sektioner



WR2-12

2 m	17 mm	25	WR2-12

Linjal i rostfritt stål med både metrisk skala och tum-skala



1179-FLX

160 mm	12 mm	25	1179-FLX

Metrisk linjaler i rostfritt stål



SR MM

150 mm	19 mm	12	SR150-MM
200 mm	19 mm	12	SR200-MM
300 mm	25 mm	12	SR300-MM
600 mm	30 mm	20	SR600-MM
1000 mm	35 mm	20	SR1000-MM



Linjaler av rostfritt stål med tum-skala



SR IN

SR	IN	QTY	Part No.
6 in	6 in	12	SR150-E
8 in	8 in	12	SR200-E
12 in	12 in	12	SR300-E
24 in	24 in	20	SR600-E
39 in	40 in	20	SR1000-E

VINKELHAKAR

Snickarvinklar med stålklina



9045-B

SR	IN	QTY	Part No.
220 mm	170 mm	6	9045-B-200
250 mm	170 mm	6	9045-B-250
300 mm	170 mm	6	9045-B-300
400 mm	170 mm	1	9045-B-400

Snickarvinklar med blad av rostfritt stål och flyttbar markör



9048

SR	IN	QTY	Part No.
200 mm	165 mm	10	9048-200
250 mm	165 mm	10	9048-250
300 mm	180 mm	10	9048-300
350 mm	180 mm	10	9048-350
400 mm	180 mm	10	9048-400

Vinkelhakar för planering och montering

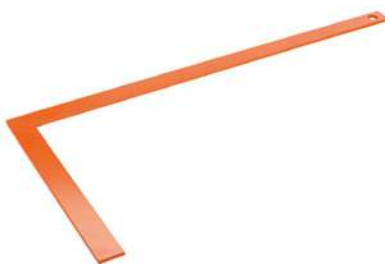

3085

SR	IN	QTY	Part No.
400 mm	200 mm	1	308504000
500 mm	250 mm	1	308505000
600 mm	300 mm	1	308506000
800 mm	400 mm	1	308508000
1000 mm	500 mm	1	308510000

Skjutbara kombinationsvinkelhakar med rits i metall



CS

SR	IN	QTY	Part No.
152 mm	90 mm	12	CS150
305 mm	125 mm	12	CS300
407 mm	125 mm	12	CS400

Spare parts, 4 pcs set.

Reservdelssats till CS kombinationsvinkelhake – 4 delar

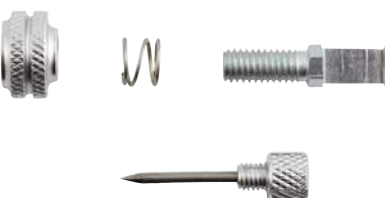

CS-SPARE

SR	IN	QTY	Part No.
CS150, CS300, CS400		1	CS-SPARE

Smygvinklar med klinga i kallvalsat stål



9572

SR	IN	QTY	Part No.
235 mm	115 mm	20	9572-200
250 mm	150 mm	20	9572-250

Smygvinklar med stålklina



9574

SR	IN	QTY	Part No.
215 mm	165 mm	10	9574-200
285 mm	170 mm	10	9574-250
300 mm	170 mm	10	9574-300

Smygvinklar med blad av rostfritt stål



9575

SR	IN	QTY	Part No.
250 mm	110 mm	6	9575-250

Snickarvinklar med stålblad



FCS-600/FCS-1000

600 mm	300 mm	6	FCS-600
800 mm	300 mm	6	FCS-800
1000 mm	360 mm	6	FCS-1000

Justerbara gipsvinklar



AS-1200

1265 mm	560 mm	3	AS-1200

PRECISIONSMÄTNING

Digitala skjutmått med LCD-skärm för precisionsmätning



1150D

150 mm	25 x 90 x 245 mm	1	1150D

Mekaniska skjutmått



1150

150 mm	9 x 75 x 235 mm	1	1150-1/2H/P

Professionella bladmått med 26 blad



1544

26	100 mm	1	1544

(0,03-0,10) x 0,01mm (0,10-1,00) x 0,05 mm Carbon steel

Professionella bladmått med 13 blad



1546

100 mm		1	1546

(0,05-0,30) x 0,05mm (0,30-1,00) x 0,10 mm Carbon steel

Professionella bladmått med 20 blad



1547

20	100 mm	20	1547

0,05 mm intervall Carbon steel

Gängmått, metrisk 60°



1535

24	67 mm	1	1535

Stainless steel

Metriska gängmått 60° och Whitworth 55°



1537

0.25-6.0 / 4-62	70 mm	1	1537

0,25-6,00 mm, 4 to 62 TPI Stainless steel





BAHCO



Väggverktyg



FÄRGSKRAPA

ERGO™ precisionsfärgskrapor med tvåkomponentshandtag



ergo



625



25 mm



5 625

ERGO™ universalfärgskrapor med tvåkomponentshandtag



ergo



650



50 mm



5 650

ERGO™ robusta färgskrapor med tvåkomponentshandtag



ergo



665



65 mm



5 665

Reservskär för färgskrapa 625 ERGO™



449



25 mm



10 449

Reservskär för färgskrapa 650 ERGO™



442



50 mm

50 mm



10 442-3P

10 442

442-3P: set of 3 blades of 442

Reservskär för färgskrapa 665 ERGO™



451



65 mm



10 451

Reservskär för 625 ERGO™ skrapor



625-

g



3 g

3 g

3 g

10 625-DROP

10 625-PEAR

10 625-ROUND

Reservskär för 650 och 665 ERGO™ färgskrapor



850 / 865



50 mm

65 mm



10 850-1

10 865-1

ERGO™ färgskrapasats med tvåkomponentshandtag



ergo



SCRAPER-SET2



50 x 145 x 265 mm



1 SCRAPER-SET2

625

625-DROP, 625-PEAR, 625-ROUND

650



Sicklingar med eggskydd av plast



474

Bladbredd	Antal	Artikelnummer
130 mm	10	474-125-0.60
130 mm	10	474-125-0.80
150 mm	10	474-150-0.60
150 mm	10	474-150-0.80

Stålspackel med skär i kolstål och trähandtag



2155

Bladbredd	Bladlängd	Antal	Artikelnummer
30 mm	195 mm	12	215500300
40 mm	195 mm	12	215500400
50 mm	195 mm	12	215500500
60 mm	215 mm	12	215500600
70 mm	220 mm	12	215500700
80 mm	225 mm	12	215500800
90 mm	230 mm	12	215500900
100 mm	234 mm	12	215501000

Stålspackel med skär i kolstål och plasthandtag



216

Bladbredd	Bladlängd	Antal	Artikelnummer
30 mm	215 mm	12	216000300
40 mm	215 mm	12	216000400
50 mm	215 mm	12	216000500
60 mm	215 mm	12	216000600
70 mm	215 mm	12	216000700
80 mm	215 mm	12	216000800
90 mm	215 mm	12	216000900
100 mm	215 mm	12	216001000
120 mm	215 mm	12	216001200

Stålspackel med skär i kolstål och tvåkomponentshandtag



2150

Bladbredd	Bladlängd	Antal	Artikelnummer
30 mm	225 mm	12	215000030
40 mm	225 mm	12	215000040
50 mm	225 mm	12	215000050
60 mm	225 mm	12	215000060
70 mm	225 mm	12	215000070
80 mm	225 mm	12	215000080
90 mm	220 mm	12	215000090
100 mm	220 mm	12	215000100
120 mm	220 mm	12	215000120

Stålspackel med skär i rostfritt stål och tvåkomponentshandtag



2161

Bladbredd	Bladlängd	Antal	Artikelnummer
40 mm	215 mm	12	216100040
60 mm	215 mm	12	216100060
80 mm	215 mm	12	216100080
100 mm	215 mm	12	216100100
120 mm	215 mm	12	216100120

Styv stålspackel med plasthandtag



2165

Bladbredd	Bladlängd	Antal	Artikelnummer
30 mm	180 mm	12	216500300
50 mm	180 mm	12	216500500
75 mm	200 mm	12	216500750
100 mm	200 mm	12	216501000

Bredspackel med blad av kolstål och trähandtag



2190

Bladbredd	Bladlängd	Antal	Artikelnummer
100 mm	235 mm	5	219001000
120 mm	230 mm	5	219001200
140 mm	245 mm	5	219001400
160 mm	235 mm	5	219001600
200 mm	245 mm	5	219002000

Bredspackel med blad av rostfritt stål och trähandtag



2192

Bladbredd	Bladlängd	Antal	Artikelnummer
100 mm	235 mm	5	219201000
120 mm	230 mm	5	219201200
140 mm	235 mm	5	219201400
160 mm	245 mm	5	219201600
200 mm	235 mm	5	219202000

Bredspackel med blad av förstärkt rostfritt stål och trähandtag



2193

Bladbredd	Antal	Artikelnummer
250 mm	10	219302500
300 mm	10	219303000
350 mm	10	219303500



Limskrapa med trekantständer



2212

	L		
130 mm	120 mm	5	221201200
130 mm	200 mm	5	221202000
130 mm	300 mm	5	221203000

Limskrapa med fyrkantständer



2213

	L		
130 mm	120 mm	5	221301200
130 mm	200 mm	5	221302000
130 mm	300 mm	5	221303000

Universalkniv med böjt blad av rostfritt stål och tvåkomponentshandtag



2488



12 2488

Kittkniv med blad av rostfritt stål och tvåkomponentshandtag



2489



12 2489

MURARVERKTYG

Murslev, katalansk modell, med trähandtag



2301

175 mm	125 mm	6	2301C0000

Murslev, Sevilla-modell, med trähandtag



2304

115 mm	200 mm	6	2304C0000

Murslev med spetsigt blad och trähandtag



2308

120 mm	70 mm	6	2308A0000
150 mm	100 mm	6	2308B0000

Murslev, Madrid-modell, med trähandtag



2303

70 mm	110 mm	6	2303B0000
80 mm	135 mm	6	2303D0000

Spackelslev med blad av kolstål och trähandtag



204

300 mm	150 mm	12	204030150
300 mm	160 mm	12	204030160
300 mm	180 mm	12	204030180
500 mm	130 mm	6	204050130

Spackelslev med trekantstandat blad av kolstål och trähandtag



209



270 mm 115 mm 12 209027040

Spackelslev med blad av rostfritt stål och lätt handtag i poppelträ



2045A

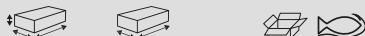

140 mm 300 mm 12 2045A3000

Spetsig rivbräda i plast med handtag av polystyren



213



265 mm 140 mm 5 213026140

Spackelslev med blad av kolstål, med fyrkantständer och trähandtag



2092



275 mm 115 mm 12 209227060
280 mm 130 mm 12 209228100
500 mm 130 mm 6 209250100

Rivbräda av plast med handtag av polystyren



211

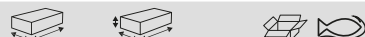

350 mm 180 mm 5 211035180
420 mm 210 mm 5 211042210

Spackelrits av aluminium med långt handtag



2127



90 mm 435 mm 6 212704350

Spackelslev med blad av rostfritt stål och långt handtag i poppelträ



2045



300 mm 140 mm 12 204530140
500 mm 130 mm 6 204550130

Rivbräda med handtag av polystyren



2120



270 mm 180 mm 5 212027180
330 mm 220 mm 8 212033220

Plan och räfflad gipsrits med trähandtag



2145xxxD

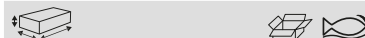

45 x 20 x 275 mm 1 2145020D0
45 x 25 x 275 mm 1 2145025D0
45 x 30 x 275 mm 1 2145030D0
45 x 35 x 275 mm 1 2145035D0



Plan gipsrits med trähandtag



2145xxxL



45 x 20 x 275 mm	1	2145020L0
45 x 25 x 275 mm	1	2145025L0
45 x 30 x 275 mm	1	2145030L0
45 x 35 x 275 mm	1	2145035L0

Kakeltvättbräda med stöttåligt handtag av polystyren och upphängningsclips



2123



140 mm	280 mm	10	212302900
--------	--------	----	-----------



Gipsrits, bågform, med träskaft



2145xxxC



45 x 25 x 225 mm	1	2145025C0
45 x 35 x 210 mm	1	2145039C0

Hård fogbräda av gummi med stöttåligt handtag av polystyren



2125



220 mm	135 mm	10	212502150
--------	--------	----	-----------



Fogbräda med stöttåligt handtag av polystyren



2122



250 mm	100 mm	10	212202500
--------	--------	----	-----------



2126



140 mm	220 mm	10	212602150
140 mm	280 mm	1	212602800



VERKTYG FÖR GIPSVÄGGAR

Lyft för gipsskivor



2504



300 x 750 x 1400 mm	1	250400000
---------------------	---	-----------

Reservdelsats med 2 fjädrar och bromsar



250400010



80 g	1	250400010
------	---	-----------

Spånfilterkabel



250400020



180 g	1	250400020
-------	---	-----------

Spånfilter, sats med delar



250400030

g	
80 g	1 250400030

Monteringsverktyg för gipsankare



250501800

L	
185 mm	50 250501800

Monteringsverktyg för gipsankare, handtag med fjäder



250502450

L	
245 mm	1 250502450

Tång för plastdetaljer med justerbar vinkel



8640

L	
230 mm	50 864002450

Blad för 8640 tång för plastdetaljer



864000010

g	
20 g	1 864000010

Guide för 864 tång för plastdetaljer



864000020

g	
20 g	1 864000020

Justerbar tång för plastdetaljer



8641

L	
245 mm	1 864102400

Blad för 8641 tång för plastdetaljer



864100010

g	
5 g	1 864100010

Stansverktyg för plåtreglar



671002600

L	
260 mm	50 671002600

Stansverktyg med böjligt huvud för plåtreglar



671002850

L	
295 mm	1 671002850





BAHCO



Bågfilar



BÅGFILAR

ERGO™ bågfil för professionellt bruk, 300 mm



ergo



325



300 mm



5 325

Bågfil med aluminiumhandtag för professionellt bruk, 300 mm



225-PLUS



300 mm



5 225-PLUS

Bågfil med mjukt grepp, för professionellt bruk, 300 mm



319



300 mm



5 319

Bågfil, 432 mm



317



432 mm



10 317

Kompakt bågfil, 470 mm



306



440 mm



10 306

Traditionella bågfilar 504 mm



320



504 mm



10 320

Traditionella bågfilar 517 mm



304



517 mm



10 304

Minibågfil med Sandflex® bimetallblad



208



330 mm



5 208

Sticksåg, 8 bladpositioner



321



330 g



5 321

Sticksåg med 4 bladpositioner



210



360 g



10 210

Minibågfilar med stålram och glasfiberhandtag 150 mm



268

150 mm	5	268

Minibågfilar med stålram och handtag 290 mm



239

260 mm	150	239

Minibågfilar med stålram och trähandtag, 150 mm



238

150 mm	60	238

Minibågfilar med stålram och trähandtag 150 mm



228

150 mm	80	228
150 mm	5	228-BULK

Minibågfilar med stålram och trähandtag 291 mm



219

291 mm	120	219

Minibågfilar med stålram och handtag 235 mm



218

235 mm	10	218
235 mm	150	218-BULK

BÅGFILSBLAD

Sandflex® bågfilsblad i bimetall för bågfil



3806-SPIRO

600 mm	32	10	3806-600-32

Sandflex® sågblad i bimetall för bågfil



3906

250 mm	18	100	3906-250-18-100
250 mm	24	100	3906-250-24-100
250 mm	32	100	3906-250-32-100
300 mm	14	100	3906-300-14-100
300 mm	18	100	3906-300-18-100
300 mm	24	100	3906-300-24-100
300 mm	32	100	3906-300-32-100
300 mm	18-28	100	3818-300-PROG-100
300 mm	14	10	3906-300-14-10P
300 mm	18	10	3906-300-18-10P
300 mm	24	10	3906-300-24-10P
300 mm	32	10	3906-300-32-10P
250 mm	18	10	3906-250-18-5P
250 mm	24	10	3906-250-24-5P
250 mm	32	10	3906-250-32-5P
300 mm	14	10	3906-300-14-5P
300 mm	18	10	3906-300-18-5P
300 mm	24	10	3906-300-24-5P
300 mm	32	10	3906-300-32-5P
300 mm	18-28	10	3818-300-PROG-5P
300 mm	18/24/32	10	3906-300-3P
300 mm	18	10	3906-300-18-2P
300 mm	24	10	3906-300-24-2P
300 mm	32	10	3906-300-32-2P



Sandcut® bågfilssblad av högkvalitativt snabbstål-HSS



3905

L	Tecken	Antal	Modell
250 mm		100	3905-250-24-100
300 mm		100	3905-300-14-100
300 mm		100	3905-300-18-100
300 mm		100	3905-300-24-100
300 mm		100	3905-300-32-100
300 mm		10	3905-300-24-2P

Reservblad minibågfil



228-P

L	Tecken	Antal	Modell
150 mm		10	228-15-5P
150 mm		10	228-32-5P
150 mm		10	228-32-10P
150 mm		1	228-32-100P

Bågfilssblad med hårdmetallbestyckning



3816

L	Tecken	Antal	Modell
300 mm		50	3816-300

Sågblad för minibågfil, 150-300 mm



216-R

L	Tecken	Antal	Modell
150 mm		1	216-150-R
300 mm		1	216-300-R

Sågblad för minibågfil, 150 mm



215

L	Tecken	Antal	Modell
150 mm		1	215-150

Sandflex® reservbågfilssblad



321-SB

L	Tecken	Antal	Modell
310 mm		10	321-7-SB
310 mm		10	321-18-SB
310 mm		10	321-24-SB



Handsågar



HANDSÅGAR FÖR BYGGMATERIAL

ProfCut™ allroundsåg



PC-GNP

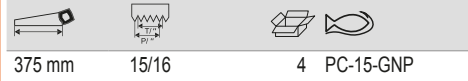

375 mm 15/16 4 PC-15-GNP

Superior™ allroundsågklinga, passar ERGO™ EX-handtag



EX-16-GNP-C

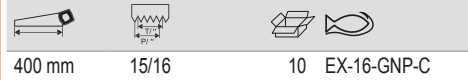

400 mm 15/16 10 EX-16-GNP-C

Superior™ sticksåg för trä och plast



3150



300 mm 9/10 4 3150-12-XT9-HP

PrizeCut™ sticksåg för trä och plast



NP-COM

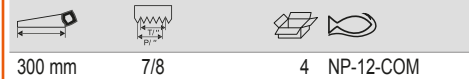

300 mm 7/8 4 NP-12-COM

ProfCut™ sticksåg för trä/plast



PC-COM



300 mm 9/10 4 PC-12-COM

Sticksågar för gipsskivor och byggskivor av träbaserat material



PC-6-DRY



160 mm 8 6 PC-6-DRY

ProfCut™ handsågar för gipsskivor och träfiberskivor



PC-PLS

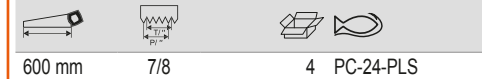

600 mm 7/8 4 PC-24-PLS

Superior™ sågklinga för gips- och spånskivor, passar ERGO™ EX-handtag



EX-22-PLS-C



550 mm 7/8 10 EX-22-PLS-C

ProfCut™ handsåg för hårda plaströr/profiler



PC-22-PLC



550 mm 11/12 4 PC-22-PLC

ProfCut™ handsåg för polystyren, stuccaturprofiler, skummaterial



PC-DECO

400 mm	18/19	4	PC-16-DECO

ProfCut™ handsågar för lättbetong/Leca®/tegelstenar



256

650 mm	2	4	256-26

Handsåg för allroundbruk, lämpad för plast, laminat, trä och mjuk metall



300

350 mm	15/16	4	300-14-F15/16-HP

ProfCut™ handsågar för lättbetong/Leca®/tegelstenar 1,3 tdr/tum



255-34

620 mm	1,3	2	255-34

Isoleringsågar för mineralull, stenull, ekoull och Styrex®



PC-22-INS

550 mm	WT	4	PC-22-INS

Reservsågblad för allroundbruk



369

360 mm	13/14	20	369-BLADE

ProfCut™ handsågar för lättbetong/Leca®/tegelsten 0,6 tdr/tum



255-17/34

620 mm	0.6	2	255-17/34

Hopfällbar såg utvecklad för sågning av isoleringsmaterial av mineralull och liknande



396-INS

190 mm	WT	10	396-INS

HANDSÅGAR FÖR TRÄ

PrizeCut™ universalhandsåg för trä, laminat, plast och mjuk metall



NP

400 mm	7/8	4	NP-16-U7/8-HP
475 mm	7/8	10	NP-19-U7/8-HP
550 mm	7/8	10	NP-22-U7/8-HP



PrizeCut™ sågklinga för fina och medelgrova material, passar ERGO™ EX-handtag



EX-NPP-22

550 mm	7/8	10	EX-NPP-22



PrizeCut™ sågklinga för alla typer av trä, passar ERGO™ EX-handtag



EX-22-U7

550 mm	7/8	10	EX-22-U7



ERGO™ Superior™ sågar för trä och träbaserade byggsivor



2600-16

400 mm	11/12	4	2600-16-XT11-HP



Superior™ sågklingor för medelgrova till grova material, används med ERGO™ EX-handtag



EX-XT9

475 mm	9/10	10	EX-19-XT9-C
550 mm	9/10	10	EX-22-XT9-C



ProfCut™ tandspetshärdade handsågar för gipsskivor/byggskivor av träbaserat material



PC-GT7

475 mm	7/8	4	PC-19-GT7
550 mm	7/8	4	PC-22-GT7



ERGO™ Superior™ ryggsåg för trä, laminat, plast och mjuk metall



3180

350 mm	11/12	4	3180-14-XT11-HP



PrizeCut™ handsåg för grova och medelgrova trämaterial



NP-FLEEM

550 mm	7	10	NP-22-F7/8-HP



Filbar universalhandsåg för trä, plast, laminat och mjuk metall



PC-FILE

400 mm	7/8	4	PC-16-FILE-U7
475 mm	7/8	4	PC-19-FILE-U7
550 mm	7/8	4	PC-22-FILE-U7
600 mm	7/8	4	PC-24-FILE-U7



ERGO™ Superior™ fanersåg för plywood och plast



3240

350 mm	11/12	4	3240-14-XT11-HP



ERGO™ Superior™ sågar för trä och träbaserade byggskivor



ergo



2600



475 mm	9/10	4	2600-19-XT-HP
550 mm	9/10	4	2600-22-XT-HP

Superior™ sågklinga för laminat- och trägolv, passar ERGO™ EX-handtag



EX-20-LAM-C

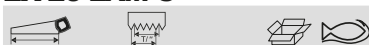

500 mm	11/12	10	EX-20-LAM-C
--------	-------	----	-------------

Superior™ sågklinga för fina och medelgrova material, passar ERGO™ EX-handtag



EX-20-XT11-C

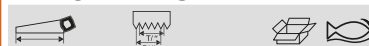

500 mm	11/12	10	EX-20-XT11-C
--------	-------	----	--------------

ERGO™ Superior™ såg för laminat, trä, plast och mjuk metall



ergo



3090



500 mm	11/12	4	3090-20-XT11-HP
--------	-------	---	-----------------

ProfCut™ laminatsåg för laminat- och trägolv



PC-LAM

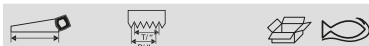

500 mm	11/12	4	PC-20-LAM
--------	-------	---	-----------

Superior™ ryggsågs klinga för plast, laminat, trä och mjuk metall, passar ERGO™ EX-handtag



EX-14-TEN-C



350 mm	11/12	10	EX-14-TEN-C
--------	-------	----	-------------

Handsågar för plast/laminat/trä/mjuk metall



ERGO™ Superior™ laminatsåg för laminat- och trägolv



ergo



244



500 mm	7/8	10	244-20-U7/8-HP
550 mm	7/8	10	244-22-U7/8-HP

SUP-LAM

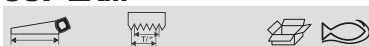

500 mm	11/12	4	SUP-20-LAM
--------	-------	---	------------

Superior™ fanersågs klinga för plywood och plast, passar ERGO™ EX-handtag



EX-14-VEN-C



350 mm	11/12	10	EX-14-VEN-C
--------	-------	----	-------------



ProfCut™ tandspetshärdad handsåg för lövträ, plywood och tunna profiler



PC-GT9

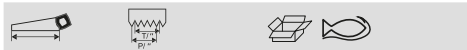

475 mm	9/10	4	PC-19-GT9
550 mm	9/10	4	PC-22-GT9

PrizeCut™ tandspetshärdad handsåg för fina och medelgrova material



PC-VEN

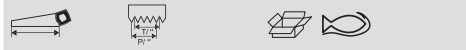

300 mm	11/12	4	PC-12-VEN
--------	-------	---	-----------

PrizeCut™ fanersåg för fina och medelgrova material



NP-VEN



300 mm	13/14	10	NP-12-VEN
--------	-------	----	-----------

ProfCut™ Kort handsåg för fina till medelgrova material



PC-TBX



375 mm	11/12	4	PC-15-TBX
--------	-------	---	-----------

ProfCut™ sågblad för fint eller medelgrovt material



PC-PRC

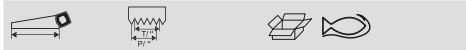

500 mm	9/10	4	PC-20-PRC
--------	------	---	-----------

Superior™ sågklingor för grova/kraftiga material, används med ERGO™™ EX-handtag



EX-XT7

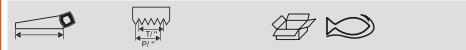

550 mm	7/8	10	EX-22-XT7-C
600 mm	7/8	10	EX-24-XT7-C

ProfCut™ ryggsåg för medelgrova material



PC-TEN



300 mm	11/12	4	PC-12-TEN
--------	-------	---	-----------

PrizeCut™ ryggsåg för fina och medelgrova material



NP-TEN

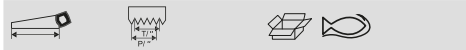

300 mm	13/14	10	NP-12-TEN
--------	-------	----	-----------

Barracuda sågklingor för medelgrova till grova material, används med ERGO™™ EX-handtag



EX-244P-22

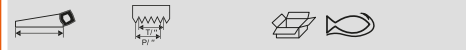

550 mm	7/8	10	EX-244P-22
--------	-----	----	------------

Handsågar för medelgrovt till grovt trä



244P

500 mm	7/8	4	244P-20-U7-HP
550 mm	7/8	10	244P-22-U7-HP

ERGO™ Superior handsåg för virke, färskt och tryckimpregnerat trä



2700

550 mm	7/8	4	2700-22-XT7-HP
600 mm	7/8	4	2700-24-XT7-HP

ProfCut™ sågar för timmer, färskt trä och tryckimpregnerat trä



PC-TIM

600 mm	3.5/4.5	4	PC-24-TIM

Geringslåda med löstagbar sidovägg



233

65 x 135 x 300 mm	5 233-300
75 x 135 x 300 mm	5 233-300-A
65 x 135 x 400 mm	5 233-400

Laminerade geringslådor



234-W

53 x 77 x 245 mm	10 234-W1
63 x 95 x 300 mm	10 234-W2
80 x 100 x 300 mm	10 234-W3

Geringslåda i aluminium



234-A

55 x 65 x 245 mm	1 234-A1
40 x 106 x 245 mm	1 234-A2

PRECISIONSHANDSÅGAR

ProfCut™ japansåg för sågning i fint material



PC-12-PS

305 mm	13.5	4	PC-12-14-PS
305 mm	13.5	10	PC-12-14-PS-B

ProfCut™ ryggsågar, sk. japansågar för trä och plast



PC-11-PS

270 mm	18.5	4	PC-11-19-PS
270 mm	18.5	10	PC-11-19-PS-B

ProfCut™ dubbla japansågar för trä och plast



PC-9-PS

240 mm	6-8.5 / 17	4	PC-9-9/17-PS
240 mm	6-8.5 / 17	10	PC-9-9/17-PS-B



ProfCut™ specialsåg med vinklat trähandtag



PC-DTF

250 mm	15/16	10	PC-10-DTF



ProfCut™ specialsågar med rakt trähandtag



PC-DTR

250 mm	15/16	10	PC-10-DTR



ProfCut™ specialsågar med vinklat trähandtag



PC-DTL

250 mm	15/16	10	PC-10-DTL



HANDTAG OCH SKÄRPVERKTYG

ERGO™ BHS-handtag för EX-sågblad stl. Large



ergo



EX-

120 x 330 x 60 mm	4	EX-LL
120 x 330 x 60 mm	4	EX-RM
120 x 330 x 60 mm	4	EX-RL



Lövsågar med båge och trähandtag



502

130 mm	25	502



Lövsågsseter, 2 delar



502-SET2

2	130 g	35	502-SET2



Professionellt skärpstål i hårdmetall



SHARP-INS

206 mm	100	SHARP-INS



LÖVSÅGAR OCH SÅGBLAD

Lövsågar med trähandtag



302

130 mm	30	302



Lövsågsseter, 6 delar



502-SET6

6	500 g	10	502-SET6

Sats med reservblad för lövsåg 302 och 502



302-6X4P



130 mm



1 302-6X4P

Reservblad för lövsåg, för sågning i trä och plast



302W



1	130 mm	1	302-51W-12P
3	130 mm	1	302-53W-12P
5	130 mm	1	302-55W-12P
7	130 mm	1	302-57W-12P
9	130 mm	1	302-59W-12P
11	130 mm	1	302-511W-12P

MUSIKSÅG

Musiksåg med trähandtag



296



750 mm



1 296

Reservblad för lövsåg, för metallsågning



302M



1	130 mm	1	302-71M-12P
3	130 mm	1	302-73M-12P
5	130 mm	1	302-75M-12P
7	130 mm	1	302-77M-12P

FIGURSÅGAR OCH SÅGBLAD

Figursågar med trähandtag



301



165 mm



50 301

Reservspiralblad för lövsåg, för sågning i trä och plast



302S



1	130 mm	1	302-81S-12P
3	130 mm	1	302-83S-12P
5	130 mm	1	302-85S-12P

Blad till figursåg 301

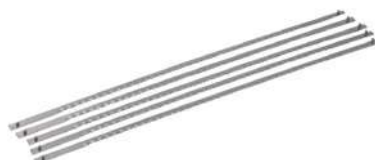

303



165 mm



10 303-5P



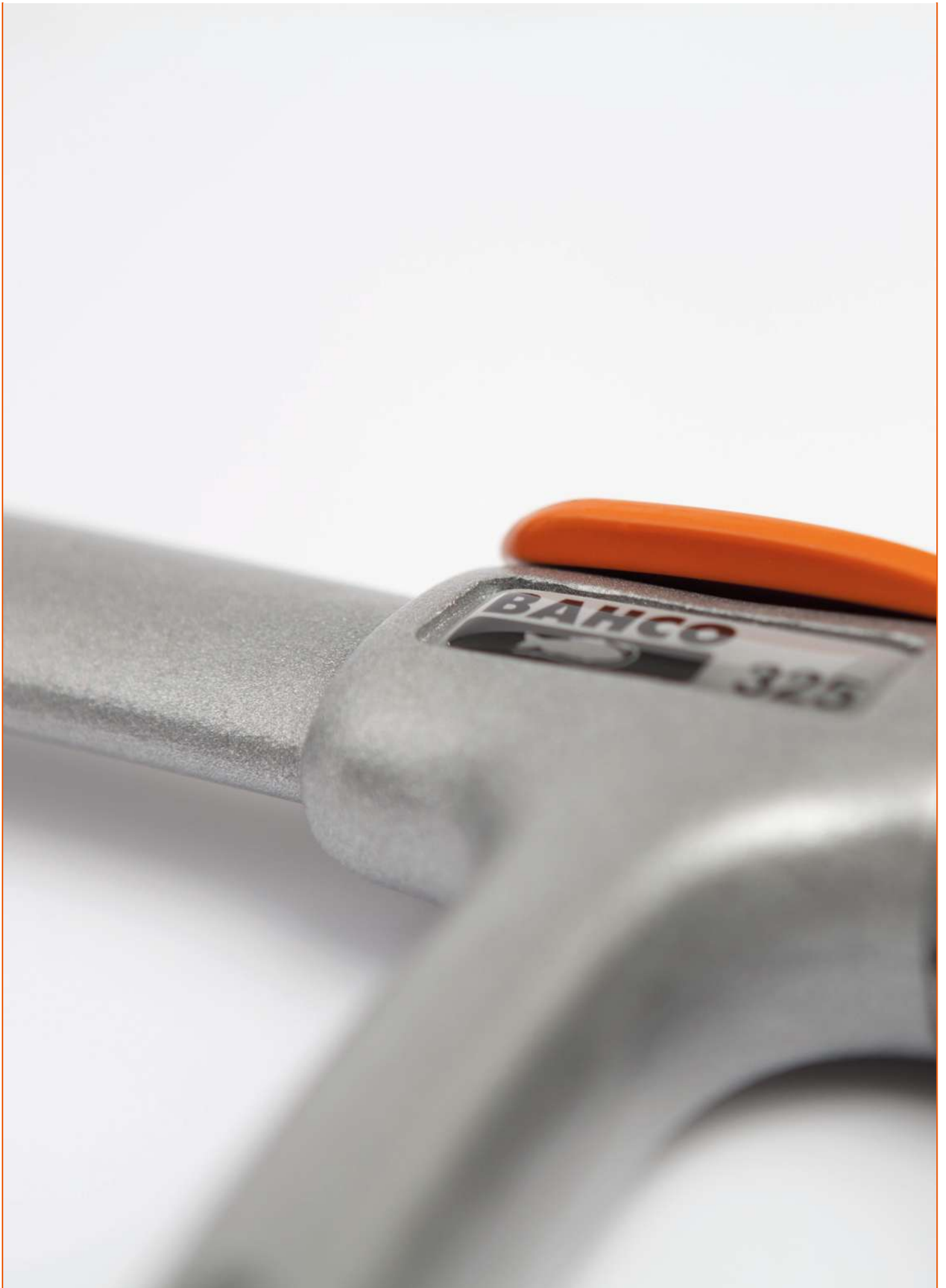

BAHCO



Stämjärn



STÄMJÄRN FÖR TRÄBEARBETNING

ERGO™ slagtåliga stämjärn för trä



ergo



434

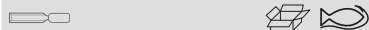

6 mm	4	434-6
8 mm	4	434-8
10 mm	4	434-10
12 mm	4	434-12
14 mm	4	434-14
15 mm	4	434-15
16 mm	4	434-16
18 mm	4	434-18
20 mm	4	434-20
22 mm	4	434-22
25 mm	4	434-25
28 mm	4	434-28
30 mm	4	434-30
32 mm	4	434-32
35 mm	4	434-35
38 mm	4	434-38
50 mm	4	434-50

Kan användas för hårt arbete tillsammans med stålhammare

ERGO™ sats med slagtåliga stämjärn-3 delar/kartong



ergo



434-S3-EUR

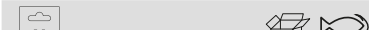

3 1 434-S3-EUR

Kan användas för hårt arbete tillsammans med stålhammare

434-12, 434-18, 434-25

ERGO™ sats med slagtåliga stämjärn i läderbindel, 6 delar



ergo



434-S6-LR

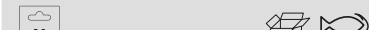

6 1 434-S6-LR

Passar för hårt arbete med metallhammare

434-6, 434-10, 434-12, 434-18, 434-25, 434-32

ERGO™ sats med slagtåliga stämjärn-6 delar/trälåda



ergo



434-S6-EUR

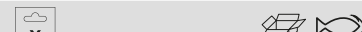

6 1 434-S6-EUR

Kan användas för hårt arbete tillsammans med stålhammare

434-6, 434-10, 434-12, 434-18, 434-25, 434-32

ERGO™ sats med slagtåliga stämjärn-8 delar



ergo



434-S8-EUR

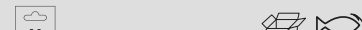

8 1 434-S8-EUR

Kan användas för hårt arbete tillsammans med stålhammare

434-6, 434-10, 434-12, 434-16, 434-18, 434-25, 434-32, 434-38

ERGO™ sats med slagtåliga stämjärn-6 delar/polyesteretui



ergo



434-S6-PP

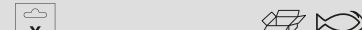

6 1 434-S6-PP

Kan användas för hårt arbete tillsammans med stålhammare

434-6, 434-10, 434-12, 434-18, 434-25, 434-32

Stämjärn för träbearbetning med gummerat handtag



424P

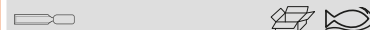

4 mm	4	424P-4
6 mm	4	424P-6
8 mm	4	424P-8
10 mm	4	424P-10
12 mm	4	424P-12
14 mm	4	424P-14
15 mm	4	424P-15
16 mm	4	424P-16
18 mm	4	424P-18
20 mm	4	424P-20
22 mm	4	424P-22
24 mm	4	424P-24
25 mm	4	424P-25
26 mm	4	424P-26
28 mm	4	424P-28
30 mm	4	424P-30
32 mm	4	424P-32
35 mm	4	424P-35
38 mm	4	424P-38
40 mm	4	424P-40

Sats med stämjärn med gummerade handtag-3 delar/kartong



424P-S3-EUR

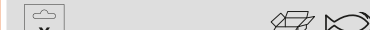

3 1 424P-S3-EUR

424P-12, 424P-18, 424P-25

Sats med huggmejslar för professionellt bruk med tvåkomponentshandtag i läderbindel, 6 delar



424P-S6-LR

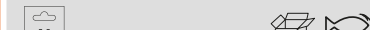

6 1 424P-S6-LR

424P-6, 424P-10, 424P-12, 424P-18, 424P-25, 424P-32

Stämjärnssats med gummerat handtag-6 delar/trälåda



424P-S6-EUR



6 1 424P-S6-EUR

424P-6, 424P-10, 424P-12, 424P-18, 424P-25, 424P-32



Stämjärnssats med gummerat handtag-6 delar/trälåda



424P-S6-GER



6 1 424P-S6-GER

424P-6, 424P-10, 424P-12, 424P-16, 424P-20, 424P-26



Stämjärnssats med gummerat handtag-8 delar/trälåda



424P-S8-EUR



8 1 424P-S8-EUR

424P-6, 424P-10, 424P-12, 424P-16, 424P-18, 424P-25, 424P-32, 424P-38



Stämjärnssats med tvåkomponentshandtag-6 delar i polyesteretui



424P-S6-PP



6 1 424P-S6-PP

424P-6, 424P-10, 424P-12, 424P-18, 424P-25, 424P-32



Stämjärn för träbearbetning, med orange polypropenhandtag



414



6 mm	4	414-6
8 mm	4	414-8
10 mm	4	414-10
12 mm	4	414-12
14 mm	4	414-14
15 mm	4	414-15
16 mm	4	414-16
18 mm	4	414-18
20 mm	4	414-20
22 mm	4	414-22
25 mm	4	414-25
28 mm	4	414-28
30 mm	4	414-30
32 mm	4	414-32
35 mm	4	414-35
38 mm	4	414-38

Stämjärn för träbearbetning med rött polypropenhandtag



1031



4 mm	5	1031-4
6 mm	5	1031-6
8 mm	5	1031-8

10 mm	5 1031-10
12 mm	5 1031-12
14 mm	5 1031-14
16 mm	5 1031-16
18 mm	5 1031-18
20 mm	5 1031-20
22 mm	5 1031-22
25 mm	5 1031-25
28 mm	5 1031-28
30 mm	5 1031-30
32 mm	5 1031-32
40 mm	5 1031-40

Stämjärnssats med polypropenhandtag-3 delar/kartong



414-S3-EUR



3 1 414-S3-EUR

414-12, 414-18, 414-25



Stämjärnssats med polypropenhandtag-5 delar/blisterpack



9883



5 1 9883

1031-6, 1031-12, 1031-16, 1031-20, 1031-25



Stämjärn för träbearbetning, med trähandtag



425

Stämjärn	Antal	Varuslag
4 mm	4	425-4
6 mm	4	425-6
8 mm	4	425-8
10 mm	4	425-10
12 mm	4	425-12
14 mm	4	425-14
15 mm	4	425-15
16 mm	4	425-16
18 mm	4	425-18
20 mm	4	425-20
22 mm	4	425-22
24 mm	4	425-24
25 mm	4	425-25
26 mm	4	425-26
28 mm	4	425-28
30 mm	4	425-30
32 mm	4	425-32
35 mm	4	425-35
38 mm	4	425-38
40 mm	4	425-40

Stämjärnssats med trähandtag-5 delar



425-082

Varuslag	Antal	Varuslag
X	5	1 425-082

425-6, 425-10, 425-12, 425-18, 425-25

Stämjärnssats med trähandtag-6 delar/ trälåda



425-083

Varuslag	Antal	Varuslag
X	6	1 425-083

425-6, 425-10, 425-12, 425-18, 425-25, 425-32

Sats med 3 st stämjärn med trähandtag. Levereras i en pappkartong



425-081

Varuslag	Antal	Varuslag
X	3	1 425-081

425-12, 425-18, 425-25

Handtag till stämjärn 1031



956

Varuslag	Antal	Varuslag
L	108 mm	50 g
X	1	956

SKÖLPAR

Skölpar med tvåkomponentshandtag



422P

Stämjärn	Antal	Varuslag
6 mm	4	422P-6
10 mm	4	422P-10
12 mm	4	422P-12
16 mm	4	422P-16
20 mm	4	422P-20
25 mm	4	422P-25

STÄMJÄRN FÖR GROVARBETE

Robusta stämjärnknivar med gummerade handtag



2448

Stämjärn	Längd (L)	Antal	Varuslag
25 mm	231 mm	12	2448
25 mm	240 mm	12	SB-2448

Robusta grovknivar med gummerade handtag



2449

Stämjärn	Längd (L)	Antal	Varuslag
25 mm	240 mm	12	2449
25 mm	231 mm	10	SB-2449

TILLBEHÖR TILL STÄMJÄRN

Bryne i naturmaterial



528-700



150 mm



1 528-700

Bryne med två kornstorlekar



528-COM



150 mm



1 528-COM

Hyvel



BP-40



160 mm



1 BP-40

Slipkloss



SBC110



30 x 65 x 110 mm



67 g



1 SBC110-65

Hyvelstål



BP-40-95



112 mm



55 g



12 BP-40-95

Plasthölster



WC-HOL



292 mm



1 WC-HOL





BAHCO



Saxar och knivar



PLÅTSAXAR

Rakklippande plåtsax med utväxling för ökad kraft och gult handtag



MA421



250 mm



10 MA421

Högerklippande plåtsax med utväxling för ökad kraft samt färgkod, grönt handtag, för plåt på upp till 1,8 mm



MA321



260 mm



10 MA321

8697M0260: Reservdelssats

Rakklippande plåtsax med utväxling för ökad kraft



MA225



250 mm



4 MA225

Lång, rakklippande fasonsax med utväxling, orange handtag



MA431



290 mm



1 MA431

8698M0250: Reservdelssats

Vänsterklippande plåtsax med utväxling för ökad kraft samt rött färgkodat handtag, för plåt på upp till 1,5 mm



MA401



250 mm



10 MA401

8698M0250: Reservdelssats

Högerklippande plåtsax med utväxling för ökad kraft



MA225R



250 mm



4 MA225R

Högerklippande plåtsax med utväxling för ökad kraft och grönt handtag



MA411



250 mm



10 MA411

8698M0250: Reservdelssats

Vänsterklippande plåtsax med utväxling för ökad kraft samt färgkod, rött handtag, för plåt på upp till 1,8 mm



MA311



260 mm



1 MA311

8697M0260: Reservdelssats

Vänsterklippande plåtsax med utväxling för ökad kraft



MA225L



250 mm



4 MA225L

Högerklippande plåtsax med utväxling för ökad kraft samt färgkod, grönt handtag



MA361



260 mm



10 MA361

8697M0260: Reservdelssats

Lång rakkippande plåtsax



MR340



340 mm



2 MR340

Höger- och rakkippande plåtsax för mjuka till medelhårda material



585D



280 mm



4 585D

Vänsterklippande plåtsax med utväxling för ökad kraft samt färgkod, rött handtag



MA351



250 mm



10 MA351

8697M0260: Reservdelssats

Höger- och rakkippande plåtsax för medelhårda till hårda material



583D



280 mm



4 583D

Vinklad vänster- och rakkippande plåtsax för mjuka/medelhårda material



586D



280 mm



4 586D

Rakkippande plåtsax med utväxling för ökad kraft



MA325



250 mm



4 MA325

Vinklad vänster- och rakkippande plåtsax för medelhårda/hårda material



584D



280 mm



4 584D

Vänster- och rakkippande traditionell industriplåtsax med tunna skär



M227L



270 mm



4 M227L



Höger- och rakklippande traditionell industriplåtsax med tunna skär



M227R



270 mm



4 M227R

Högerklippande industriplåtsax



8691



255 mm
300 mm



6 869102500
6 869103000

Höger- och rakklippande traditionell industriplåtsax med tunna skär och retur fjäder



MR227R



270 mm

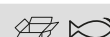

4 MR227R

Lång vinklad rakklippande traditionell industriplåtsax



M330



11 3/4 mm



4 M330

Traditionell industriplåtsax



8692



300 mm



6 869203000

Vinklad rakklippande tvåhandsplåtsax med utväxling



M6376



760 mm



1 M6376
1 M6376-SH

Rakkippande traditionell industriplåtsax med kraftiga skär



M526



260 mm



4 M526

Vänster- och rakkippande traditionell industriplåtsax med tunna skär och retur fjäder



MR227L



270 mm



4 MR227L

Rakkippande tvåhandsplåtsax med utväxling



M676



760 mm



1 M676
1 M676-SH

Nibblingsax med skärm som skyddar ögonen



M926

250 mm	1 M926	1 M926-SH

Extra kraftig elektrikersax med uttag för kabelskalning



SCB140G

43 mm	140 mm	10	SCB140G

Elektrikersax med extra långa handtag



SC150NG

38 mm	155 mm	10	SC150NG

Kraftig universalsax



2744

190 mm	6	2744

Elektrikersax med sågtandat blad som tillval



SC127/SC127S

45 mm	130 mm	10	SC127
45 mm	127 mm	10	SC127S

Specialsax med böjda skär



2704

110 mm	1	2704A

SAXAR

Extra kraftig elektrikersax



SCB140

90 mm	140 mm	10	SCB140

Elektrikersax med böjt blad som tillval



SC140/SC140C

50 mm	145 mm	10	SC140
50 mm	145 mm	10	SC140C

Specialtång med fint räfflade skär



2705R

160 mm	1	2705R



KNIVAR

ERGO™ universalkniv med skjutbart blad



ergo



KERU01



170 mm 26 mm 5 KERU-01

ERGO™ universalkniv med fast blad



ergo



KEFU-01



170 mm 26 mm 5 KEFU-01

ERGO™ universalkniv med 18 mm brytblad



ergo



KE18-01

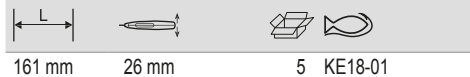

161 mm 26 mm 5 KE18-01

Universalkniv med indragbart blad med grepp i termoplastgummi



KBRU-01



170 mm 26 mm 5 KBRU-01

Universalkniv med skjutbart blad



KGRU-01

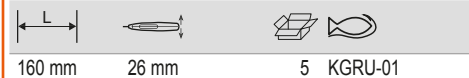

160 mm 26 mm 5 KGRU-01

Universalkniv med skjutbart blad



KGRU-02



145 mm 26 mm 5 KGRU-02

Miniuniversalkniv med skjutbart blad



KMU-01



90 mm 26 mm 5 KMU-01

Universalkniv med indragbart blad med gummigrepp



SQZ150003

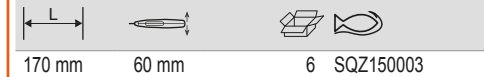

170 mm 60 mm 6 SQZ150003

Universalkniv med fast blad och handtag av termoplastgummi



KBFU-01

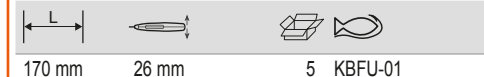

170 mm 26 mm 5 KBFU-01

Universalkniv med fast blad



KGFU-01



160 mm 26 mm 5 KGFU-01

Knivblad för universalkniv – 100 st.



KBGU



0,635 x 19 x 60 mm



1 KBGU-100P

Knivblad med krok för universalkniv – 5 st. i behållare



KBGH-5P-DISPEN



0,635 x 19 x 51 mm



20 KBGH-5P-DISPEN

Krokformade blad för SQZ150003 universalknivar



SQZ150003-HSBL



51 mm



6 SQZ150003-HSBL

Knivblad för universalkniv – 5 st. i behållare



KBGU-5P-DISPEN



0,635 x 19 x 60 mm



20 KBGU-5P-DISPEN

Säkerhetsknivblad för universalkniv – 5 st. i behållare



KBGR-5P-DISPEN



0,635 x 19 x 55 mm



20 KBGR-5P-DISPEN

Brytbladskniv med handtag av termoplastgummi och 9 mm brytblad



KB09-01



140 mm



5 KB09-01

Knivblad för universalkniv – 10 st. i behållare



KBGU-10P-DISPEN



0,635 x 19 x 60 mm



20 KBGU-10P-DISPEN

Fasade säkerhetsblad för SQZ150003 universalknivar



SQZ150003-SBL



60 mm



1 SQZ150003-SBL

Brytbladskniv med handtag av termoplastgummi och 18 mm brytblad



KB18-01



160 mm



5 KB18-01



Brytbladskniv med 9 mm blad



KG09-01



140 mm
140 mm



5 KG09-01
10 KG09-01-3P

Blad för knivar med utskjutbart blad-5 st/
hängförpackning



KUBG



0.7 x 85 x 9 mm
1 x 110 x 18 mm



20 KUBG09-5P
20 KUBG18-5P

Universalkniv med skjutbart blad



KGAU-01



160 mm



5 KGAU-01

Brytbladskniv med 18 mm blad



KG18-01



160 mm



5 KG18-01

Blad för knivar med utskjutbart blad 18
mm-5 st/behållare



KUBG18-5DISPEN



15 x 30 x 130 mm



20 KUBG18-5DISPEN

Hölster för universalknivar



KHU-01



90 g

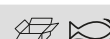

4 KHU-01

Brytblad för knivar med utskjutbart blad 9
mm-10 st/behållare



KSBG09-10DISPEN



1 x 9 x 85 mm



20 KSBG09-10DISPEN

Brytblad för knivar med utskjutbart blad 18
mm-10 st/behållare



KSBG18-10DISPEN



15 x 30 x 130 mm



20 KSBG18-10DISPEN

Liten universalkniv med indragbart blad
och gummigrepp



SQZ-MINI



160 mm



24 SQZ-MINI

Små indragbara blad för SQZ-MINI universalkniv



SQZ-MINI-BLADE



28 mm



1 SQZ-MINI-BLADE

Universalkniv med fällbart blad och aluminiumhandtag



KBSU-01



5 KBSU-01

Kniv Laplander med grönt och svart tvåkomponentshandtag



2446-LAP



218 mm



102 mm



15 2446-LAP

Universalkniv med dubbla fällbara blad och aluminiumhandtag



KBTU-01



5 KBTU-01

Universalkniv med fällbart blad och polyamidhandtag



KGSU-01



5 KGSU-01

Robusta allroundknivar – hängförpackade



SB-2444



220 mm



100 mm



1 SB-2444

Fällknivar för att kapa rep



KBSK-01



5 KBSK-01

Allroundknivar med tvåkomponentshandtag – 15 st./bordsdisplay



2444



15 2444

Allroundknivar med tvåkomponentshandtag och hölster med knapp för en andra kniv



2446



225 mm



100 mm



15 2446



Allroundknivar med rostfritt blad och tvåkomponentshandtag – 15 st./bordsdisplay



2446-BL



218 mm 102 mm 15 2446-BL

Elektrikerkniv som kan användas både med vänster och höger hand



2446-EL

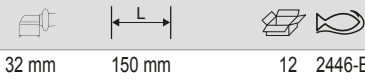

32 mm 150 mm 12 2446-EL

Elektrikerkniv för högerhänta



2446-ELR



34 mm 145 mm 12 2446-ELR

Allroundkniv med tvåkomponentshandtag och trubbig säkerhetsspets



2446-SAFE

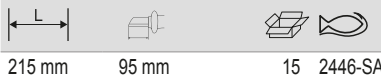

215 mm 95 mm 15 2446-SAFE

Elektrikerkniv för både vänster- och högerhänta, hängförpackad



SB2446-EL



150 mm 32 mm 10 SB2446-EL

Allroundkniv med tvåkomponentshandtag och specialhölster



2446-OV



220 mm 100 mm 15 2446-OV

Allroundkniv för linoleummattor – 12 st./bordsdisplay



2446-LINO

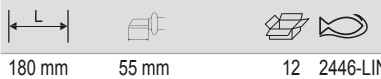

180 mm 55 mm 12 2446-LINO

Elektrikerkniv för vänsterhänta



2446-ELL

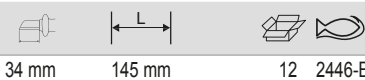

34 mm 145 mm 12 2446-ELL

Elektrikerkniv med böjd spets



2446-EL-HELP



43 mm 12 2446-EL-HELP

Allroundknivar med enkomponentshandtag
– 15 st./bordsdisplay



1446

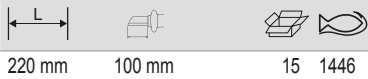

220 mm 100 mm 15 1446

Allroundknivar med kolst lsblad
och enkomponentshandtag – 15 st./
bordsdisplay



1446-CS



218 mm 102 mm 15 1446-CS

Flytande r ddningskniv med
fluorescerande handtag



1446-FLOAT

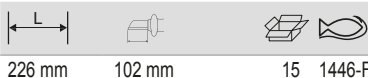

226 mm 102 mm 15 1446-FLOAT

Hink f r 1446-knivar



BUCKET 1446

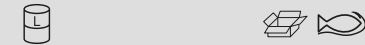

30 l 75 BUCKET 1446

Allroundkniv med enkomponentshandtag
och specialh lster



1446-OV



225 mm 100 mm 15 1446-OV

Doskniv med tr ehandtag



2820EK-01

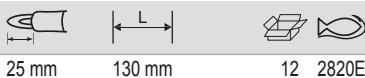

25 mm 130 mm 12 2820EK-01

Elektrikerkniv med 70 mm tandat blad



2820EK

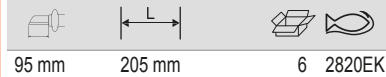

95 mm 205 mm 6 2820EK

F llkniv f r elektriker med 60 mm blad



2820EF1



90 mm 200 mm 12 2820EF1

F llkniv f r elektriker med 65 mm blad



2820EF2

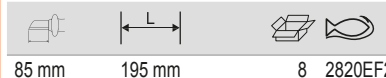

85 mm 195 mm 8 2820EF2



Fällkniv för elektriker med 70 mm blad



2820EF3



80 mm 170 mm 1 2820EF3

18-i-1-multiverktyg i aluminium



MTT121



110 mm 8 MTT121

Klickskrapa med handtag i tvåkomponentsplast



KBWS-01



70 g 10 KBWS-01

Fällkniv för elektriker med dubbla blad på 70/85 mm



2820EF4



75-85 mm 170 mm 1 2820EF4

12-i-1-multiverktyg i aluminium



MTT051



165 mm 6 MTT051

18-i-1-multiverktyg i aluminium



MTT151



150 mm 6 MTT151

Klickskrapa i metall med utbytbart blad



KRSS-01



80 g 10 KRSS-01



Tvingar och skruvstycken



TVINGAR

Snabbtvingar med 200 kg tryckkraft



QCB

L	QCB
456 mm	6 QCB-150
606 mm	6 QCB-300
756 mm	6 QCB-450
906 mm	4 QCB-600
1206 mm	4 QCB-900
1556 mm	8 QCB-1250

Snabbtvingar med 125 kg tryckkraft



QCG

L	QCG
380 mm	6 QCG-150
530 mm	6 QCG-300

Tåliga snabbtvingar



QC

X	L	QC
1	230 mm	12 QC-115A
2	230 mm	6 QC-115A-2P
1	305 mm	6 QC-150A
2	305 mm	6 QC-150A-2P
1	475 mm	6 QC-300A
2	475 mm	4 QC-300A-2P

-2P: Twin Pack

Skruvting i stål, 90 mm



3066

L	3066
250 mm	90 mm 5 306601500
300 mm	90 mm 5 306602000
400 mm	90 mm 5 306603000
510 mm	90 mm 5 306604000

Skruvting i stål, 120 mm



3067

L	3067
415 mm	125 mm 5 306703000
510 mm	125 mm 5 306704000
610 mm	125 mm 5 306705000
710 mm	125 mm 5 306706000
910 mm	125 mm 5 306708000
1115 mm	125 mm 5 306710000
1310 mm	125 mm 2 306712000
1610 mm	125 mm 2 306715000

Skruvting i stål, 150 mm



3068

L	3068
430 mm	155 mm 5 306803000
535 mm	155 mm 5 306804000
640 mm	155 mm 2 306805000
730 mm	155 mm 2 306806000
820 mm	155 mm 2 306808000
1135 mm	155 mm 2 306810000
1335 mm	155 mm 2 306812000
1630 mm	155 mm 1 306815000
2130 mm	155 mm 1 306820000

Skruvting i stål, 220 mm



3069

L	3069
430 mm	225 mm 2 306903000
540 mm	225 mm 2 306904000
638 mm	225 mm 2 306905000
730 mm	225 mm 2 306906000
932 mm	225 mm 2 306908000
1130 mm	225 mm 2 306910000

Tving med gummihandtag



420SH

L	420SH
100 mm	50 mm 10 420SH-50-100
200 mm	50 mm 10 420SH-50-200
120 mm	60 mm 12 420SH-60-120
300 mm	60 mm 12 420SH-60-300
160 mm	80 mm 12 420SH-80-160
200 mm	100 mm 10 420SH-100-200
250 mm	120 mm 8 420SH-120-250
300 mm	120 mm 8 420SH-120-300
400 mm	120 mm 6 420SH-120-400
500 mm	120 mm 6 420SH-120-500
600 mm	120 mm 6 420SH-120-600
800 mm	120 mm 6 420SH-120-800
1000 mm	120 mm 6 420SH-120-1000
1250 mm	120 mm 6 420SH-120-1250
1500 mm	120 mm 6 420SH-120-1500
400 mm	140 mm 6 420SH-140-400
400 mm	175 mm 6 420SH-175-400

Praktisk fjädertving med rörliga grepppylor



420SC

g	g	10	420SC-25
25 mm	60 g	5	420SC-50
50 mm	120 g		

Kraftfullt skruvstycke med rund guide med utbytbara backar, passar för vridbar bas



6010

g	g	1	601000800
80 mm		1	601001000
100 mm		1	601001250
125 mm		1	601001500
150 mm			

Par med reservrörbackar för skruvstycke 834V-4, 834V-7 och 6072



833P

g	g	1	833PJ-4
100 mm		1	833PJ-5
125 mm		1	833PJ-67
150 / 175 mm			

SKRUVSTYCKEN, BÄNKMODELL

Kraftfullt skruvstycke med fyrkantig guide med utbytbara backar



834V

g	g	1	834V-4
100 mm		1	834V-5
125 mm		1	834V-6
150 mm		1	834V-7
175 mm			

Skjutreglerad skruv Med backar för rör

Flyttbart skruvstycke med rund guide och utbytbara backar



834V-2

g	g	1	834V-2
63 mm			

Reservspindlar och muttrar för skruvstyckena 6072 och 834V



6070H

g	g	1	6070H1000
100 mm		1	6070H1250
125 mm		1	6070H1500
150 mm		1	6070H1750
175 mm			

Kraftfullt skruvstycke med fyrkantig guide med utbytbara backar, passar för vridbar bas



6072

g	g	1	607201000
100 mm		1	607201250
125 mm		1	607201500
150 mm		1	607201750
175 mm			

Par med reservbackar och skruvar för skruvstyckena 6072 och 834V



6072M

g	g	1	6072M1000
100 mm	834V-4, 607201000	1	6072M1500
150 mm	834V-6, 607201500	1	6072M1750
175 mm	834V-7, 607201750		

125 mm size jaw common for round & square models

Par med reservbackar och skruvar för skruvstycke 6010



6010M

g	g	1	6010M0800
80 mm	601000800	1	6010M1000
100 mm	601001000	1	6010M1250
125 mm	834V-5, 607201250, 601001250	1	6010M1500
150 mm	601001500		

125 mm size jaw common for round & square models



Reservspindel och bult för skruvstycke
6010



6010H

↓ ↑	↓ ↑	↓ ↑
80 mm	1	6010H0800
100 mm	1	6010H1000
125 mm	1	6010H1250
150 mm	1	6010H1500

Par med reservbackar i aluminium med
magnetremsa



833AJ

↓ ↑	↓ ↑	↓ ↑
100 mm	1	833AJ-4
125 mm	1	833AJ-5
150 mm	1	833AJ-6

Par med reservbackar för skruvstycke
834V-2



6040M/H

↓ ↑	↓ ↑	↓ ↑
63 mm	1	6040M0630

Par med reservbackar i polyuretan med
magnetremsa



833FJ

↓ ↑	↓ ↑	↓ ↑
100 mm	1	833FJ-4
125 mm	1	833FJ-5
150 mm	1	833FJ-6

TILLBEHÖR TILL BÄNKSkrUVSTYCKEN

Vridplatta för skruvstyckena 6010/6072
och 834V



833SB

↓ ↑	↓ ↑	↓ ↑
80 mm	100 mm	1 833SB-4
100 mm	125 mm	1 833SB-5
125 mm	150 mm	1 833SB-6
150 mm	175 mm	1 833SB-7



Hammare



KLOHAMMARE

ERGO™ klohammare med gummigrepp



ergo



529

g	
450 g	4 529-16-L
450 g	4 529-16-XL
570 g	4 529-20-L
570 g	4 529-20-XL

ERGO™ rak klohammare med tvåkomponents gummigrepp



ergo



529S

g	
450 g	4 529S-16-XL
570 g	4 529S-20-XL

Klohammare med stål rörshandtag med gummigrepp



429

g	
230 g	4 429-8
370 g	4 429-13
450 g	4 429-16
570 g	4 429-20

Klohammare med glasfiberhandtag med gummigrepp



428

g	
450 g	4 428-16

Hammare med böjd klo och gummigrepp



428F

g	
230 g	4 428F-8
370 g	4 428F-13
454 g	4 428F-16
567 g	4 428F-20
680 g	4 428F-24

Hammare med rak klo och gummigrepp



428S

g	
454 g	4 428S-16
567 g	4 428S-20

Klohammare med slinfritt träskaft



427

g	
370 g	4 427-13
680 g	4 427-24
230 g	4 427-8
450 g	4 427-16
570 g	4 427-20

Klohammare med rak klo och polerat huvud



427S

g	
454 g	4 427S-16
567 g	4 427S-20

Snickarhammare av spansk modell med räfflat hickoryskaft



427

g	
700 g	6 427-700

Snickarhammare av spansk modell med glasfiberskaft och trekomponentsgrepp



428

700 g	6	428-700

SPIKUTDRAGARE

Kompakt spikutdragare med handtag av termoplastisk elastomer



36

220 mm	5	36

VERKSTADSHAMMARE

Kulhammare med hickoryskaft



479

230 g	6	479-08
340 g	6	479-12
450 g	6	479-16
570 g	6	479-20
800 g	6	479-24
900 g	6	479-32

Kulhammare med glasfiberskaft



479F

230 g	6	479F-08
340 g	6	479F-12
450 g	6	479F-16
570 g	6	479F-20
680 g	6	479F-24
900 g	6	479F-32

Plåtslagarhammare



481

100 g	6	481-100
200 g	6	481-200
300 g	6	481-300
400 g	6	481-400
500 g	6	481-500
800 g	6	481-800
1000 g	6	481-1000
1500 g	6	481-1500
2000 g	6	481-2000

Plåtslagarhammare med glasfiberskaft



481F

100 g	6	481F-100
200 g	4	481F-200

300 g	6	481F-300
400 g	6	481F-400
500 g	6	481F-500
800 g	6	481F-800
1000 g	6	481F-1000
1500 g	4	481F-1500
2000 g	4	481F-2000

Verkstadshammare av fransk modell med slintfritt skaft



482

300 g	6	482-25
400 g	6	482-28
500 g	6	482-30
800 g	6	482-35
1000 g	6	482-40
1500 g	6	482-45

Verkstadshammare med glasfiberskaft



482F

300 g	4	482F-25
400 g	4	482F-28
470 g	6	482F-30
800 g	4	482F-35
1000 g	2	482F-40
1500 g	4	482F-45



Penhammare, traditionell engelsk modell



480

Weight	Quantity	Model
230 g	4	480-08
280 g	6	480-10
340 g	6	480-12
400 g	4	480-14
570 g	4	480-20

Snickarhammare med pik och smitt huvud



485W

Weight	Quantity	Model
650 g	6	485W-650
750 g	6	485W-750
	1	SH-485W
	1	SH-485W-PLATES

Penhammare med hickoryskaft



490

Weight	Quantity	Model
100 g	4	490-3.5

Kulhammare med pen och hickoryskaft



492

Weight	Quantity	Model
100 g	4	492-3.5

Snickarhammare av fransk modell



483

Weight	Quantity	Model
100 g	6	483-16
160 g	6	483-20
200 g	6	483-22
300 g	6	483-25
400 g	6	483-28
500 g	6	483-30

Mejselhammare med skaft av hickory



484

Weight	Quantity	Model
1000 g	6	484-1000
1250 g	6	484-1250
1500 g	6	484-1500
2000 g	4	484-2000

SPECIALHAMMARE

Snickarhammare med pik och rörformigt stålskaft



485

Weight	Quantity	Model
600 g	6	485

Snickerihammare med glasfiberskaft



483F

Weight	Quantity	Model
100 g	6	483F-16
160 g	6	483F-20
200 g	6	483F-22
300 g	6	483F-25
400 g	6	483F-28
500 g	4	483F-30

Mejselhammare med glasfiberskaft



484F

Weight	Quantity	Model
1000 g	6	484F-1000
1250 g	6	484F-1250
1500 g	6	484F-1500
2000 g	4	484F-2000

Slägghammare av spansk typ med ovalt öga



407

700 g	5	407-700
1000 g	6	407-1000
1400 g	6	407-1400

Slägga med fyrkantigt huvud och trekomponentsskaft



488F

2000 g	2	488F-2000
3000 g	2	488F-3000
4000 g	2	488F-4000
5000 g	4	488F-5000
6000 g	2	488F-6000

Murarhammare av spansk typ med glasfiberskaft



486F

700 g	6	486F-700

Mejselhammare med glasfiberskaft



407F

700 g	6	407F-700
1000 g	6	407F-1000
1400 g	6	407F-1400

Murarhammare med hickoryskaft



486W

500 g	4	486W-500
600 g	4	486W-600
	1	SH-486W

Murarhammare med gummigrepp



486

600 g	4	486

Slägga med fyrkantigt huvud och hickoryskaft



488

2000 g	2	488-2000
3000 g	2	488-3000
4000 g	2	488-4000
5000 g	2	488-5000
6000 g	1	488-6000

Murarhammare av spansk typ med hickoryskaft



486-700

700 g	6	486-700

Putshake med spets



4401

255 mm	10	440102500
300 mm	10	440103000



Reservskaft i trä för hammare



WSH

WSH	SH	SH
407	1	SH-407
491-3000 & 491-4000	12	SH-491-34
491-5000 & 491-6000	12	SH-491-56
488-2000	10	SH-488-2000
488-3000, 488-4000	10	SH-488-34
488-5000, 488-6000	10	SH-488-56
427-700	10	SH-427-700
486-700, 495-500, 495-600, 493-500, 493-600	10	SH-486-493-495

Hacka av spansk modell med glasfiberskaft



493F

493F	SH	SH
500 g	6	493F-500
600 g	1	493F-600

Gipshammare med rörformigt stålskaft



494

494	SH	SH
600 g	4	494-600

Reservskaft i glasfiber



FSH

FSH	SH	SH
488f-2000	10	SH-488F-2000
488F-3000 & 488F-4000	1	SH-488F-34
488F-5000 & 488F-6000	1	SH-488F-56
428-700	10	SH-428-700
486F-700, 495F-500, 495F-600, 493F-500, 493F-600	10	SH-486F493F495F

Hacka av spansk modell med hickoryskaft



495

495	SH	SH
500 g	6	495-500
600 g	6	495-600

SLÄGGOR

Studsfri hammare med träskaft



3625AR

3625AR	SH	SH
550 g	34	3625AR-35
1430 g	18	3625AR-50
1550 g	12	3625AR-60

SPECIALHAMMARE

Hacka av spansk modell med träskaft



493

493	SH	SH
500 g	6	493-500
600 g	6	493-600

Hacka av spansk modell med glasfiberskaft



495F

495F	SH	SH
500 g	6	495F-500
600 g	1	495F-600

Reservslagytor till hammare 3625AR



3625ARL

3625ARL	SH	SH
35 mm	6	3625ARL-35
50 mm	6	3625ARL-50
60 mm	6	3625ARL-60

Reservskaft till hammare 3625AR



3625ARLH

	L		
3625AR-35	290 mm	80	3625ARLH-35
3625AR-60	300 mm	50	3625ARLH-50
3625AR-60	390 mm	16	3625ARLH-60

Smidesslägga med hickoryskaft



491

3000 g		4	491-3000
4000 g		4	491-4000
5000 g		4	491-5000
6000 g		4	491-6000

HAMMARE MED MJUK SLAGYTA OCH GUMMIHAMMARE

Polyuretanelastomerhammare med träskaft



3625Y

g			
120 g		6	3625Y-22
225 g		6	3625Y-32
372 g		6	3625Y-40
484 g		6	3625Y-50

Studsfri slägga med slintfritt handtag



3625PU

300 g		12	3625PU-30
790 g		6	3625PU-50
1080 g		6	3625PU-60

Säkerhetsslägga 99/105 mm med gummihandtag



489-1100/489-1800

1100 g		8	489-1100
1800 g		8	489-1800

Två slagtytor för 3625Y Polyflex-hammare med slagtytor av plast



3625YL

3625Y-22	22 mm	20	3625YL-22
3625Y-32	32 mm	20	3625YL-32
3625Y-40	40 mm	20	3625YL-40
3625Y-50	50 mm	20	3625YL-50

Studsfri slägga med slintfritt skaft, 105 mm



3625PU-105

	g		
5000 g	5600 g	4	3625PU-105

Säkerhetsslägga 150/190 mm med gummihandtag



489-2700/489-5400

2700 g		4	489-2700
3600 g		4	489-3600
4500 g		4	489-4500
5400 g		4	489-5400

Cellulosaacetathammare med träskaft



3625N

g			
120 g		6	3625N-22
225 g		6	3625N-32
372 g		6	3625N-40
484 g		6	3625N-50



Två slagytor för 3625N SUPERFLEX hammare med slagytor av plast



3625NL



3625N-22	22 mm	20	3625NL-22
3625N-32	32 mm	20	3625NL-32
3625N-40	40 mm	20	3625NL-40
3625N-50	50 mm	20	3625NL-50

Hammare med slagytor av nylon och trähandtag



3625W



150 g	120	3625W-22
250 g	72	3625W-28
490 g	40	3625W-35
1050 g	1	3625W-44
1470 g	12	3625W-55

Ett par slagytor för 3625W och 3625S, hammare med slagytor av nylon



3625WL



3625W-22	22 mm	10	3625WL-22
3625W-28, 3625S-28	28 mm	10	3625WL-28
3625W-35, 3625S-35	35 mm	10	3625WL-35
3625W-44, 3625S-44	44 mm	10	3625WL-44
3625W-55	55 mm	6	3625WL-55

Reservskaft till hammare 3625W



3625WLH



3625W-22	50	3625WLH-22
3625W-28	50	3625WLH-28
3625W-35	80	3625WLH-35
3625W-44	50	3625WLH-44
3625W-55	16	3625WLH-55

Hammare med slagytor av nylon och gummigrepp



3625S



350 g	50	3625S-28
610 g	30	3625S-35
1100 g	18	3625S-44

Gummihammare med träskaft



3625RM



290 g	50	3625RM-55
460 g	40	3625RM-65
660 g	30	3625RM-75
850 g	20	3625RM-90

Kopparslägga med mjuk slagyta



4130

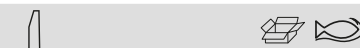

500 g	12	413005000
1000 g	12	413010000
1500 g	12	413015000
2000 g	6	413020000
3000 g	1	413030000
4000 g	1	413040000



Skogshandverktyg



YXOR, RÖJYXOR OCH SLÄGGOR

Campingyxor med svängt skaft i askträ, amerikansk modell, 380 mm–500 mm



HUS

mm	g	Styck	Modell
380 mm	830 g	4	HUS-0.6-380
500 mm	1030 g	4	HUS-0.8-500

Campingyxor med svängt skaft i askträ



HGPS

mm	g	Styck	Modell
380 mm	944 g	4	HGPS-0.8-380-WB
400 mm	1130 g	4	HGPS-1.0-400-WB
360 mm	810 g	10	HGPS-0.6-360
380 mm	930 g	4	HGPS-0.8-380
400 mm	1180 g	4	HGPS-1.0-400

Campingyxor med kompositthandtag



CUC

mm	g	Styck	Modell
360 mm	640 g	4	CUC-0.4-360

Campingyxor med svängt skaft i askträ och Yankeemodell, 650 mm



HUS-1.0-650

mm	g	Styck	Modell
650 mm	1610 g	4	HUS-1.0-650

60 cm yxor med fiberglashandtag



CUC-0.8-600

mm	g	Styck	Modell
600 mm	1220 g	4	CUC-0.8-600

Campingyxor med glasfiberhandtag



HFGPS

mm	g	Styck	Modell
380 mm	1010 g	4	HFGPS-0,7-400FG

Fällyxa med svängt skaft i askträ 800



FGS-810

mm	g	Styck	Modell
800 mm	2230 g	4	FGS-1.6-810
800 mm	2480 g	4	FGS-1.8-810

Fällyxor i Kanadamodell med handtag av hickoryträ



FCP

mm	g	Styck	Modell
800 mm	2540 g	4	FCP-1.8-810
850 mm	3000 g	2	FCP-2.3-860

Fällyxa med svängt skaft i askträ 600 mm–700 mm



FGS

mm	g	Styck	Modell
700 mm	1730 g	4	FGS-1.25-700-WB
810 mm	2210 g	4	FGS-1.6-810-WB
600 mm	1330 g	4	FGS-1.0-600
700 mm	1850 g	4	FGS-1.25-700

Fällyxor med fiberglashandtag



FFSS

mm	g	Styck	Modell
900 mm	2400 g	4	FFSS-1.5-900FG

Klyvvyxor med svängt skaft av askträ



SUS

mm	g	Styck	Modell
800 mm	2660 g	4	SUS-2.0-800

Klyvvyxor med skaft av hickoryträ



MCP

L	g	Icon	Icon	Product
800 mm	3300 g			2 MCP-2.5-810

Klyvvyxor med kompositskaft



SUC

L	g	Icon	Icon	Product
450 mm	980 g			4 SUC-0.7-450
600 mm	1310 g			4 SUC-0.9-600
710 mm	1550 g			4 SUC-1.0-710
780 mm	2300 g			4 SUC-1.7-800

Släggor med ask- eller 3-komponentshandtag och två plana ytor



LS-MASSE

L	g	Icon	Icon	Product
900 mm	4800 g			2 LS-MASSE-4FG
900 mm	4450 g			2 LS-MASSE-4

Släggyxa med trekomponentsskaft och en plan yta



LS-MASSE-TR

L	g	Icon	Icon	Product
900 mm	4840 g			2 LS-MASSE-TR-4FG

Skaft i trä för yxor



SH

L	Icon	Icon	Product
800 mm			1 SH-FCS-810
900 mm			1 SH-FCS-860
600 mm			1 SH-FGS-600
700 mm			12 SH-FGS-700
800 mm			1 SH-FGS-800
900 mm			1 SH-FGS-1.8-810
375 mm			1 SH-HGFS-400FG
400 mm			1 SH-HGFS-400
900 mm			12 SH-MES-F-900
360 mm			12 SH-HGFS-360
380 mm			1 SH-HGFS-380
380 mm			1 SH-HUS-380
500 mm			1 SH-HUS-500
650 mm			1 SH-HUS-650
900 mm			12 SH-MES-900
915 mm			12 SH-MES-900FG
800 mm			12 SH-SUS-800
800 mm			1 SH-MCS-800
905 mm			1 SH-FCP-860

Klyvvyxor med ask-/3-komponentshandtag och en plan yta



LS/MES

L	g	Icon	Icon	Product
900 mm	3270 g			2 LS-MERLIN-2.5
900 mm	3330 g			2 LS-MERLIN-2.5FG
900 mm	3620 g			2 MES-3.0-900

Klyvvyxor med skaft av ask eller 3-komponentshandtag och en plan yta



MES

L	g	Icon	Icon	Product
900 mm	3880 g			2 MES-3.5-900
900 mm	4310 g			2 MES-3.5-900FG

Korp för byggnadsarbete, med glasfiberskaft



PAGS-2.0-900FG

L	g	Icon	Icon	Product
900 mm	3000 g			1 PAGS-2.0-900FG

Korp med runt öga för byggnadsarbete



PAGS

L	g	Icon	Icon	Product
450 mm	2000 g			1 PAGS-2.0

Skaft i askträ eller glasfiber för korpar med runt öga



SH-PAGS

L	g	Icon	Icon	Product
900 mm	690 g			1 SH-PAGS-900
920 mm	1030 g			1 SH-PAGS-900FG



KILAR

Fällkilar i syntet



LS-COIN

↔ L	g	📦	🐟
260 mm	295 g	2	LS-COIN 26 CM
190 mm	170 g	4	LS-COIN 19 CM

Vriden klyvkil i stål



WT

↔ L	g	📦	🐟
220 mm	2000 g	4	W-T-2.0

Traditionell, rak klyvkil i stål



WS

↔ L	g	📦	🐟
220 mm	1500 g	4	W-S-1.5
250 mm	2000 g	4	W-S-2.0
260 mm	2500 g	4	W-S-2.5



Huggmejslar och dornar



HUGGMEJSLAR

Plan huggmejsel med plastöverdragen åttkantig kropp



3656

L	h	Q	Q
129 mm	12 mm	50	3656-125
155 mm	16 mm	50	3656-150
178 mm	19,5 mm	1	3656-175

Huggmejsel med platt oval kropp och svartoxiderad yta



3640

L	h	Q	Q
150 mm	18 mm	25	3640-150-C
175 mm	21 mm	6	3640-175-C
200 mm	22 mm	25	3640-200-C
250 mm	28 mm	20	3640-250-C
300 mm	26 mm	25	3640-300-C

Kryssmejsel med platt oval kropp och kopparfärgad lackerad yta



3745

L	Ø	Q	Q
150 mm	6 mm	50	3745-150
175 mm	7 mm	25	3745-175
200 mm	8 mm	20	3745-200
250 mm	9 mm	10	3745-250

Huggmejsel med platt oval kropp och kopparfärgad lackerad yta



3740

L	Q	Q
100 mm	50	3740-100
125 mm	50	3740-125
150 mm	50	3740-150
175 mm	25	3740-175
200 mm	25	3740-200
250 mm	10	3740-250
300 mm	10	3740-300

Huggmejsel med åttkantig kropp och kopparfärgad lackerad yta



3756

L	h	Q	Q
125 mm	10 mm	50	3756-125
150 mm	12 mm	50	3756-150

Kryssmejsel med åttkantig kropp och kopparfärgad lackerad yta



3749

L	Ø	Q	Q
125 mm	10 mm	50	3749-125

Huggmejsel med platt ovalt skaft och kopparfärgad lackerad yta, hängförpackad



SB-3740

L	Q	Q
125 mm	87	SB-3740-125
150 mm	25	SB-3740-150
175 mm	25	SB-3740-175
200 mm	25	SB-3740-200
250 mm	25	SB-3740-250
300 mm	25	SB-3740-300

Kryssmejsel med plan plastöverdragen åttkantig kropp



3649

L	Ø	Q	Q
128 mm	12 mm	50	3649-125

Slitsmejsel med platt oval kropp och kopparfärgad lackerad yta



3750

L	h	Q	Q
240 mm	26 mm	25	3750

Betongmejsel med åttkantig kropp och kopparfärgad lackerad yta



3736M

L	Q	Q	Q
200 mm	30	3736M-200	
250 mm	25	3736M-250	
300 mm	10	3736M-300	
400 mm	10	3736M-400	

Huggmejsel med långt platt skaft



8740

L	Q	Q	Q
200 mm	5	874002000	
250 mm	5	874002500	
300 mm	5	874003000	
350 mm	5	874003500	
400 mm	5	874004000	
500 mm	5	874005000	

Huggmejselsats med kopparfärgad lackerad yta – 6 st./låda



3736S/6

g	Q	Q	Q
840 g	5	3736S/6	

3735-4-120, 3735-5-150

3733-3

3749-125

3756-125, 3756-150

Kryssmejsel med åttkantig kropp och kopparfärgad lackerad yta



3739-250 / -400

L	Q	Q	Q
250 mm	16 mm	25	3739-250
300 mm	18 mm	10	3739-300
400 mm	18 mm	10	3739-400

HUGGMEJSLAR MED SKYDD

Slitsmejsel med platt oval kropp och handskydd



3750H

L	Q	Q	Q
240 mm		25	3750H

Betongmejsel med åttkantig kropp och handskydd



3736MH

L	Q	Q	Q
250 mm		10	3736MH-250
300 mm		10	3736MH-300
400 mm		5	3736MH-400

Kryssmejsel med åttkantig kropp och handskydd



3739H

L	Q	Q	Q
250 mm	16 mm	15	3739H-250
300 mm	18 mm	10	3739H-300
400 mm	18 mm	10	3739H-400

HUGGMEJSLAR, OMSLIPNINGSBARA

Omslipningsbar huggmejsel med platt skaft och handskydd



8741

L	Q	Q	Q
200 mm		6	874102000
250 mm		5	874102500
300 mm		5	874103000
350 mm		4	874103500
400 mm		5	874104000

Omslipningsbar körnare med åttkantig kropp



8746

L	Q	Q	Q
200 mm	14 mm	5	874602000
250 mm	14 mm	5	874602500
300 mm	16 mm	5	874603000
350 mm	16 mm	5	874603500
400 mm	18 mm	5	874604000



Omslipningsbar huggmejsel för elektriker med åttkantig kropp



8760



200 mm	10	876002000
250 mm	5	876002500

Omslipningsbar huggmejsel med extra platt skaft



8770



240 mm	25	877002400
--------	----	-----------

HUGGMEJSLAR-TILLBEHÖR

Handskydd för huggmejsel



8749



1	874916X16
1	874918X18
1	874923X13
1	874926X7

DORN

Körnare med åttkantig kropp och handskydd



3643

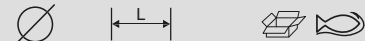

3 mm	100 mm	50	3643-100
4 mm	120 mm	50	3643-120
5 mm	120 mm	50	3643-150

Körnare med åttkantig kropp och kopparfärgad lackerad yta



3735

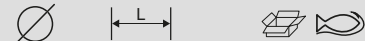

4 mm	120 mm	50	3735-4-120
5 mm	120 mm	50	3735-5-120
5 mm	150 mm	50	3735-5-150

Körnare med sexkantig kropp och förkromad yta



3735N

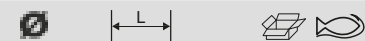

2 mm	100 mm	10	3735N-2-100
4 mm	120 mm	10	3735N-4-120
5 mm	120 mm	10	3735N-5-120
6 mm	150 mm	10	3735N-6-150
8 mm	150 mm	10	3735N-8-150
2 mm	100 mm	1	SB-3735N-2-100
4 mm	120 mm	60	SB-3735N-4-120
5 mm	120 mm	1	SB-3735N-5-120
6 mm	150 mm	1	SB-3735N-6-150
8 mm	150 mm	1	SB-3735N-8-150

SB – levereras hängförpackad på blisterkort

Körnarsats med förkromad yta – 4 st/ficka



3735NS/4



340 g	25	3735NS/4
-------	----	----------

3735N-6-150, 3735N-8-150, 3735N-2-100, 3735N-4-120

Automatkörnare med spets i härdat stål



1157



2 mm	130 mm	60	1157
------	--------	----	------

Dorn med åttkantig kropp och handskydd



3644



2 mm	120 mm	50	3644-120
3 mm	125 mm	50	3644-125
4 mm	130 mm	50	3644-130
4 mm	150 mm	50	3644-150
5 mm	165 mm	50	3644-165
6 mm	180 mm	50	3644-180
8 mm	200 mm	50	3644-200

Runda dorn med räfflade styrhylsor



3659

Ø	L	Stycketal	Varuslag
0.9 mm	70 mm	5	3659-0.9
1.4 mm	81 mm	5	3659-1.4
1.8 mm	84 mm	5	3659-1.8
2.4 mm	92 mm	5	3659-2.4
2.8 mm	95 mm	5	3659-2.8
3.4 mm	97 mm	5	3659-3.4
3.9 mm	100 mm	5	3659-3.9
5.9 mm	100 mm	5	3659-6.0

Runda dorn med åttkantig kropp och handskydd



3658A

Ø	L	Stycketal	Varuslag
2 mm	150 mm	125	3658A-2
2 mm	150 mm	125	3658A-3
4 mm	150 mm	125	3658A-4
4 mm	150 mm	125	3658A-5
6 mm	150 mm	125	3658A-6
7 mm	150 mm	50	3658A-8

Ø	L	Stycketal	Varuslag
8 mm	150 mm	10	3734N-8-150
9 mm	150 mm	10	3734N-9-150
10 mm	150 mm	10	3734N-10-150
2 mm	150 mm	1	SB-3734N-2-150
3 mm	150 mm	1	SB-3734N-3-150
4 mm	150 mm	60	SB-3734N-4-150
5 mm	150 mm	1	SB-3734N-5-150
6 mm	150 mm	60	SB-3734N-6-150
7 mm	150 mm	1	SB-3734N-7-150
8 mm	150 mm	1	SB-3734N-8-150
10 mm	150 mm	1	SB-3734N-10-150

Koniskt dorn med åttkantig kropp och kopparfärgad lackerad yta



3733

Ø	L	Stycketal	Varuslag
2 mm	120 mm	50	3733-2
3 mm	120 mm	50	3733-3
4 mm	120 mm	50	3733-4
5 mm	120 mm	50	3733-5
6 mm	120 mm	50	3733-6

Rund sprintutdrivare med åttkantig kropp och kopparfärgad lackerad yta



3734

Ø	L	Stycketal	Varuslag
2 mm	150 mm	50	3734-2
3 mm	150 mm	50	3734-3
4 mm	150 mm	50	3734-4
5 mm	150 mm	50	3734-5
6 mm	150 mm	50	3734-6
8 mm	150 mm	50	3734-8

Dornsats med finslipad spets och handskydd – 6 st./tråståll



3646/6

g	Stycketal	Varuslag
730 g	25	3646/6

3646-115, 3646-125, 3646-150, 3646-165, 3646-180, 3646-200

Runda dorn med finslipad spets, åttkantig kropp och handskydd



3646

Ø	L	Stycketal	Varuslag
2 mm	115 mm	250	3646-115
3 mm	125 mm	250	3646-125
4 mm	150 mm	125	3646-150
5 mm	165 mm	125	3646-165
6 mm	180 mm	50	3646-180
8 mm	200 mm	50	3646-200

Rund sprintutdrivare med sexkantig kropp



3734N

Ø	L	Stycketal	Varuslag
2 mm	150 mm	10	3734N-2-150
3 mm	150 mm	10	3734N-3-150
4 mm	150 mm	10	3734N-4-150
5 mm	150 mm	10	3734N-5-150
6 mm	150 mm	10	3734N-6-150
7 mm	150 mm	10	3734N-7-150

Sats med huggmejslar och dorn – 6 delar/ plastficka



3654R

g	Stycketal	Varuslag
870 g	1	3654R

2 x 3656, 1 x 3649, 2 x 3644, 1 x 3643



Dornsats med räfflade handtag – 8 st./
plastställ



3659/8

270 g	1	3659/8

3659-0.9, 3659-1.4, 3659-1.8, 3659-2.4, 3659-2.8, 3659-3.4, 3659-3.9, 3659-6.0

Sats med runda dorn med handskydd –
6 st./träställ



3658A/6

560 g	30	3658A/6

3658A-2, 3658A-3, 3658A-4, 3658A-5, 3658A-6, 3658A-8

Set med runda dorn med sexkantklinga–9
st./förp.



3734NS/9

750 g	10	3734NS/9

3734N-10-150, 3734N-9-150, 3734N-8-150, 3734N-7-150, 3734N-6-150, 3734N-5-150, 3734N-4-150, 3734N-3-150, 3734N-2-150

Set med runda dorn med åttkantig kropp–6
st./förp.



3734S/6

720 g	5	3734S/6

3734-2, 3734-3, 3734-4, 3734-5, 3734-6, 3734-8

Dornsats med räfflade handtag – 8 st./
plastficka



3659/8T

170 g	1	3659/8T

3659-0.9, 3659-2.8, 3659-2.4, 3659-1.8, 3659-6.0, 3659-3.9, 3659-3.4, 3659-1.4

Spikutdrivardorn med plasthandtag,
hängförpackad



3732

2 mm	125 mm	60	SB-3732-2-125
2,5 mm	125 mm	60	SB-3732-2.5-125
3,2 mm	125 mm	60	SB-3732-3.2-125
4 mm	125 mm	1	SB-3732-4-125

Sats med huggmejslar och dorn – 10
delar/plastficka



3656/10

1260 g	1	3656/10

3 x 3656, 1 x 3644, 1 x 3649, 1 x 3643 en 3 x 3646

Sats med konformade dorn med åttkantig
kropp – 5 st./ficka



3733S/5

410 g	25	3733S/5

3733-4, 3733-2, 3733-6

3733-8, 3733-10

Hålstansar



B400

2 mm	1	B400.002
3 mm	1	B400.003
4 mm	1	B400.004
5 mm	1	B400.005
6 mm	1	B400.006
7 mm	1	B400.007



8 mm	1	B400.008
9 mm	1	B400.009
10 mm	1	B400.010
11 mm	1	B400.011
12 mm	1	B400.012
13 mm	1	B400.013
14 mm	1	B400.014
15 mm	1	B400.015
16 mm	1	B400.016
17 mm	1	B400.017
18 mm	1	B400.018
19 mm	1	B400.019
20 mm	1	B400.020
21 mm	1	B400.021
22 mm	1	B400.022
23 mm	1	B400.023
24 mm	1	B400.024
25 mm	1	B400.025
26 mm	1	B400.026
27 mm	1	B400.027
28 mm	1	B400.028
29 mm	1	B400.029
30 mm	1	B400.030
31 mm	1	B400.031
32 mm	1	B400.032
33 mm	1	B400.033
34 mm	1	B400.034
35 mm	1	B400.035
36 mm	1	B400.036
37 mm	1	B400.037
38 mm	1	B400.038
39 mm	1	B400.039
40 mm	1	B400.040
41 mm	1	B400.041
42 mm	1	B400.042
43 mm	1	B400.043
44 mm	1	B400.044
45 mm	1	B400.045
46 mm	1	B400.046
47 mm	1	B400.047
48 mm	1	B400.048
49 mm	1	B400.049
50 mm	1	B400.050

Handtag för hålstansar på 2 till 30 mm



WPH3-30



160 mm



530 g



1 WPH 3-30

Handtag för hålstansar på 2 till 50 mm



WPH2-50



170 mm



780 g



1 WPH 2-50

Handtag för hålstansar på 2 till 20 mm



WPH3-20



95 mm



320 g



1 WPH 3-20

Sats med hålstansar – 11 delar/plastväska



400.003.020



3-20 mm



1 400.003.020

Hålverktygssats-16 st./plastförpackning



400.003.030



3-30 mm



1 400.003.030

Sats med hålstansar – 32 delar/plastväska



400.002.050



2-50 mm



1 400.002.050

Håltång med plasthandtag för hål med dia. 2-4,5 mm



2635



245 mm



1 2635



Håltång för hål med dia. 2–4,5 mm



4630



220 mm



1 4630

Håltång



6900



16 mm
20 mm
22 mm
25 mm
30 mm
32 mm
35 mm
40 mm
50 mm
63 mm



1 690000160
1 690000200
1 690000220
1 690000250
1 690000300
1 690000320
1 690000350
1 690000400
1 690000500
1 690000630

Hålverktygssats – 7 delar/plastväska



6907



4080 g



1 69079019P

690000160, 690000250, 690000200, 690000320,
690000500, 690000400, 690000630



690900120, 690900080, 690900100, 690900200,
690900140



Reservskruvar för håltagare ur 6900-serien



6909



16 mm
20-25 mm
30-35 mm
40-50 mm
63 mm



4 690900080
4 690900100
2 690900120
2 690900140
1 690900200

DORN MED TVÅKOMONENTSHANDTAG

Körnare med tvåkomponentshandtag och handskydd



SB3755BM



4 mm 165 mm
6 mm 185 mm



1 SB3755BM-4
5 SB3755BM-6

SB: Hängförpackade

Cylindrisk parallellt dorn med tvåkomponentshandtag



SB3734BM



10 mm 180 mm
3 mm 155 mm
4 mm 165 mm
5 mm 165 mm
6 mm 185 mm
8 mm 185 mm



5 SB3734BM-10
5 SB3734BM-3
5 SB3734BM-4
5 SB3734BM-5
5 SB3734BM-6
5 SB3734BM-8

SB: Hängförpackade

Sats med runda dornar med tvåkomponentshandtag – 7 delar/plastbricka



3734BMS/7



900 g



1 3734BMS/7

3734BM-2, 3734BM-3, 3734BM-4, 3734BM-5, 3734BM-6, 3734BM-8, 3734BM-10

HUGGMEJSLAR MED TVÅKOMONENTSHANDTAG

Huggmejsel med tvåkomponentshandtag



SB3654BM



155 mm
185 mm



5 SB3654BM-15
5 SB3654BM-20

SB: Hängförpackade

Betongmejselsats med tvåkomponentshandtag – 7 delar/plastbricka



3654BMS/7



920 g



1 3654BMS/7

3734BM-2, 3734BM-4, 3734BM-5, 3734BM-6, 3654BM-15, 3654BM-20, 3755BM-6



Brytjärn



BRÄCKJÄRN

Justerbart bräckjärn med klys, 260 mm



APB260

260 mm	410 g	10	APB260

Justerbart bräckjärn med klys, 360 mm



APB360

360 mm	543 g	10	APB360

Bräckjärn med klys i båda ändar



CFP250

250 mm	6	CFP250

Bräckjärn med precisionsklys, 330 mm – 12 st./displayförpackning



CFP250-DISP

12	50 x 280 x 330 mm	12	CFP250-DISP

12x CFP250

CFP250x 12

Bräckjärn med bred ände



CFW250

250 mm	6	CFW250

Bräckjärn med brett klys, 330 mm – 12 st./displayförpackning



CFW250-DISP

12	50 x 280 x 330 mm	12	CFW250-DISP

CFW250x 12

Högkvalitativt kofot med en böjd och en flat ände



WBP

14 mm	346 mm	20	WBP300
16 mm	487 mm	12	WBP500
17 mm	625 mm	12	WBP625
17 mm	704 mm	10	WBP710
20 mm	890 mm	6	WBP900

Kofot med en böjd och en flat ände



WBB

391 mm	14 mm	10	WBB400
500 mm	16 mm	10	WBB500
595 mm	18 mm	10	WBB600
680 mm	18 mm	6	WBB700
810 mm	18 mm	6	WBB800
1000 mm	20 mm	4	WBB1000
1200 mm	20 mm	4	WBB1200
1500 mm	22 mm	1	WBB1500

Platt kofot med en böjd och en flat ände



WBF380

374 mm	35 mm	12	WBF380

Platt minikofot med en böjd och en flat ände



WBMF190

18 mm	188 mm	24	WBMF190

Sats med bräckjärn, premium WBP300, WBF380 & WBMF190, 346 mm



WBP-3P-3FMF

1600 g	1	WBP-3P-3FMF

Display med 15 st minibräckjärn WBMF190 med en böjd och en flat ände



WBMF190IP

39 g	15	WBMF190IP

WBP300	
WBF380	
WBMF190	

Bräckjärnssats, premium



WBP-3P-963

4740 g	1	WBP-3P-963

WBMF190x 15	
-------------	--

WBP900, WBP625, WBP300	
------------------------	--





BAHCO



Planterings- och odlingsverktyg



SKYFFLAR

Snöskyfflar med tvåkomponentshandtag - liten storlek



LST-72324



780 mm

5 LST-72324

Skyffel för tunga lyft med stort blad och tvåkomponentshandtag



LST-70120



1295 mm

5 LST-70120

SPADAR

Kantspade för gräsmatta med T-handtag



LST-63102



1045 mm

5 LST-63102

GREPAR

Grep med tvåkomponents D-handtag - medelstorlek



LST-51121



1030 mm

5 LST-51121

Grep med tvåkomponents D-handtag - storlek



LST-52121



1200 mm

5 LST-52121

KRATTOR

Liten trädgårdskratta med 12 pinnar



LST-30111



1470 mm

5 LST-30111

SMÅ TRÄDGÅRDSVERKTYG

Renshacka med tvåkomponentshandtag



P262



315 mm

10 P262

Renshacka med tvåkomponentshandtag



P272



450 mm

5 P272

Renshacka med tvåkomponentshandtag



P268



320 mm



10 P268

Renshackor med två spetsar med tvåkomponentshandtag och lång metallstång



P277



455 mm



5 P277

Rensklo med tvåkomponentshandtag



P274



470 mm



5 P274

Renshackor med en spets med tvåkomponentshandtag och lång metallstång



P278



455 mm



5 P278

Planteringspade med tvåkomponentshandtag



P263



370 mm



10 P263

Handkratta med tvåkomponentshandtag



P276



450 mm



5 P276

Renshacka med tvåkomponentshandtag



P267



320 mm



10 P267

Rensklo med tvåkomponentshandtag



P264



315 mm



10 P264

Handkratta med tvåkomponentshandtag



P266



335 mm



10 P266



Maskrosj rn med tv komponentshandtag



P269



315 mm



10 P269

Rensgaffel med tv komponentshandtag



P270



305 mm



10 P270

L kj rn med handtag i solitt tr 



P241



340 g



5 P241





Beskärningsverktyg



SEKATÖRER

ERGO™-sekatör med elastomeröverdraget fast handtag



ergo



PX

Bladdjup	Antal	Modell
15 mm	2	PX-S1
20 mm	2	PX-S2
15 mm	2	PX-M1
20 mm	2	PX-M2
20 mm	2	PX-M2-L
30 mm	2	PX-M3
20 mm	2	PX-L2
30 mm	2	PX-L3

ERGO™-sekatör med elastomeröverdraget roterande handtag



ergo



PXR

Bladdjup	Antal	Modell
20 mm	2	PXR-S2-L
15 mm	2	PXR-S1
20 mm	2	PXR-S2
15 mm	2	PXR-M1
20 mm	2	PXR-M2
20 mm	2	PXR-M2-L
30 mm	2	PXR-M3
20 mm	2	PXR-L2

Komplett skärhuvud för sekatörerna PX och PXR ERGO™



R801P-R804P

Antal	Modell
1	R801P
1	R802P
1	R803P
2	R804P

Reservskär för ERGO™-sekatörer



R211P/R300P/R500P/R600P

Modell	Antal
Px/PxR N° 2, P1-20, P2-20	1 R211P
Px/PxR N° 2, P1-20, P2-20	80 R211P-BULK80
Px/PxR N° 1	1 R300P
Px/PxR N° 3	40 R500P
Px-M2-L & PxR-M2-L	1 R600P

Motskär för sekatörerna PX och PXR ERGO™



R303P-R603P

Modell	Antal
Px-S1, Px-M1, Px-L1, PxR-M1, PxR-L1	1 R303P
Px-S2, Px-M2, Px-L2, PxR-M2, PxR-L2	1 R403P
Px-S3, Px-M3, Px-L3, PxR-M3, PxR-L3	1 R503P
Px-M2-L, PxR-M2-L	1 R603P

Handtag för sekatörerna PX och PXR ERGO™



ergo



R811P-RT825P

Modell	Antal
Px-S	1 R811P
Px-M	1 R812P
Px-L	1 R813P
Px-M2-L	1 R815P
PxR-S	1 RT821P
PxR-M	1 RT822P
PxR-L	6 RT823P
PxR-M2-L	1 RT824P
PxR-S2-L	6 RT825P

Centrumbult för ERGO™-sekatörer



R900P

Modell	Antal	Nettovikt
PX & PXR	1 R900P	20 g

Låssystem med centrumbult för ERGO™-sekatörer



R901P

Modell	Antal	Nettovikt
PX & PXR	30 R901P	10 g

Reservdelssats med fyra handtagsskruvar
och insatser för sekatorerna PX och PXR
ERGO™



R902P

Handtag	g	Insatser	Partnummer
PX & PXR	20 g	24	R902P

Fjädrar för sekatorerna P64 och ERGO™



R905P-R907P

Handtag	g	Insatser	Partnummer
PX & PXR, P64	10 g	1	R905P
PX & PXR, P64	164 g	50	R905P-BULK50
PX & PXR	10 g	1	R906P
PX & PXR	220 g	50	R906P-BULK50
PX & PXR	10 g	1	R907P

Sekatorer med komposithandtag och
vinklat huvud



P1

Bladdiameter	Längd	Insatser	Partnummer
20 mm	200 mm	5	P1-20
30 mm	230 mm	5	P1-23

Två buffertar för ERGO™-sekatorerna PX/
PXR, P1/P2 och P64



R903P/R1269P

Handtag	g	Insatser	Partnummer
PX & PXR, P1 & P2, P64	10 g	1	R903P
PX & PXR, P1 & P2, P64	486 g	50	R1269P-BULK50

Sekator med smitt stålhandtag och stort
skärhuvud



P3

Bladdiameter	Insatser	Partnummer
20 mm	2	P3-20-F
25 mm	2	P3-23-F

Sekator med mjukt komposithandtag och
smalt skärhuvud



P108

Bladdiameter	Längd	Insatser	Partnummer
20 mm	200 mm	2	P108-20-F
25 mm	230 mm	2	P108-23-F

Läs för ERGO™-sekatorerna PX och PXR



R904P

Handtag	g	Insatser	Partnummer
Px & Pxr	10 g	1	R904P

Sekator med handtag av formpressad plåt
och smalt skärhuvud



P110

Bladdiameter	Insatser	Partnummer
20 mm	2	P110-20-F
25 mm	2	P110-23-F

Sekator med smitt stålhandtag och smalt
skärhuvud



P5

Bladdiameter	Längd	Insatser	Partnummer
25 mm	230 mm	2	P5-23-F



Sekatör med mothåll och handtag av formpressad plåt



P138

20 mm	220 mm	6	P138-22-F



Sekatör med handtag av formpressad plåt och vinklat skärhuvud



P121

15 mm	180 mm	6	P121-18-F
20 mm	200 mm	6	P121-20-F
25 mm	230 mm	6	P121-23-F



Reservmothåll med nitar



R221P/R222P

P138-22	1	R221P
P138-22	50	R221P-BULK50

Sekatör med hållare och komposithandtag



P64

12 mm	210 mm	6	P64-20
12 mm	210 mm	12	P64-20-BULK12



Sekatör med handtag av formpressad plåt och rakt skärhuvud



P126

15 mm	190 mm	6	P126-19-F
20 mm	220 mm	6	P126-22-F



Skär för sekatorerna P1-22, P2-22 och P6 samt modell P7 för vänsterhänta



R201P/R171P

P1-22, P2-22	1	R201P
P1-22, P2-22	80	R201P-BULK80

Sekatör med glasfiberhandtag, passar både vänster- och högerhänta



PG-01-F/PG-03-L

12-20 mm	6	PG-01-F
12-20 mm	2	PG-03-L



Sekatör med komposithandtag, passar både vänster- och högerhänta



PG-12-F

20 mm	210 mm	10	PG-12-F
20 mm	210 mm	15	PG-12-BULK15



Reservskär till sekator P4



R301P

P4-20, P4R-20	41 g	30	R301P

Reservskär för sekatorer och grensaxar



R112PG-R124PG/R224P

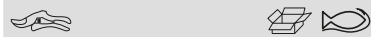

P3-20, P5-20	1	R112PG
P108-20, P110-20	1	R114PG
P3-23, P5-23	30	R122PG
P108-23, P110-23, P34-27A	30	R124PG
P138-22	1	R223P
P138-22	80	R223P-BULK80

Motskär för sekatorerna P1-22 och P2-22 samt modell P6 och P7 för vänsterhänta



R202P/R271P



P1-22, P2-22	1	R202P
--------------	---	-------

Reservmotskär till sekator P4



R304P

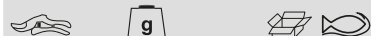

P4-20, P4R-20	45 g	1	R304P
---------------	------	---	-------

Resevcentrumbultar till sekator P4



R900P-Z



P4-20, P4-23, P4R-20, P4R-23	21 g	24	R900P-Z
------------------------------	------	----	---------

Reservfjädrar till sekator P4

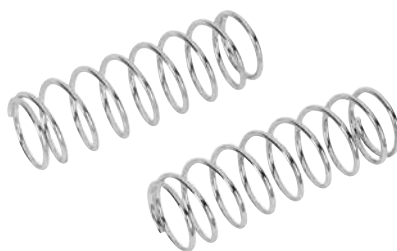

R906P-Z

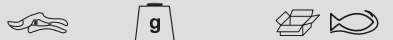

P4-20, P4-23, P4R-20, P4R-23	8 g	12	R906P-Z
------------------------------	-----	----	---------

Reservdelssats med centrumskruv, mutter och bricka för sekatorer



R239P/R141P/R142P/R157H



P34-27A, P3-20, P3-23, P5-20, P5-23, P108-20, P108-23, P110-20, P110-23	24	R142P
P1-20, P1-22, P2-20, P2-22, P6-20, P7-20	1	R239P

Reservdelssats med motskär och sprint för sekatorer



R113PG/R123PG

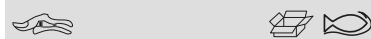

P108-20, P110-20	30	R113PG
P108-23, P110-23	30	R123PG

Låsfjädrar



R341P/R474P

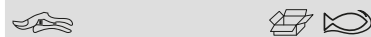

P3-20, P3-23	12	R341P
P5-20, P5-23, P108-20, P108-23, P110-20, P110-23	1	R474P

Fjädrar för sekatorer



R438P/R463P

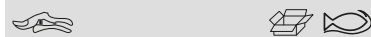

P121-23	1	R463P
P138-22	1	R438P
P138-22	50	R438P-BULK50



Reservdelssats med fjäder och buffertar för sekatorer



R1069P



P1-20, P2-20, P6-20, P7-20

12 R1069P

Reservdelssats med fjädrar, buffertar och buffertkoppar för sekatorer



R1068



P3-20, P3-23, P5-20, P5-23, P108-20, P108-23, P110-20, P110-23

1 R1068

Reservdelssats för sekatorerna P5-20 och P5-23



R1080P



P5-20, P5-23

1 R1080P

Reservdelssats med handtagsskruv, mutter och låsknapp med plattfjäder för sekatorer



R1601



P1-20, P1-22, P2-20, P6-20, P7-20

1 R1601

Reservdelssats med lås, skruv och mutter för sekatorerna P108 och P5



R478P/R480P



P108
P5

1 R478P
1 R480P

FRUKTPLOCKNINGSVERKTYG

Blomstersax med glasfiberhandtag



P123



10 mm

30 P123-19-BULK30

Rak, lång blomstersax med glasfiberhandtag



P127



6 mm

30 P127-19-BULK30

Rak, kort blomstersax med glasfiberhandtag



P128



6 mm
6 mm

6 P128-19
30 P128-19-BULK30

Blomstersax med lätt böjda (11°) stålskär och glasfiberhandtag



P129



6 mm

30 P129-19-BULK30

Reservdelssats med fjädrar och buffertar för sekatorer



R1071/R1075

	g		
P123, P127, P128, P129	20 g	14	R1071
P123, P127, P128, P129	130 g	50	R1075-BULK50

Gren sax på 30 mm med trähandtag och smitt motskär för professionellt bruk



P16-40W

	L		
30 mm	400 mm	2	P16-40W

Gren sax med aluminiumskänklar för professionellt bruk. Klippkapacitet 50 mm



P19

	L		
50 mm	800 mm	1	P19-80-F

GREN- OCH RÖJSAXAR

Lätta grensaxar med aluminiumskänklar för professionellt bruk. Klippkapacitet 30 mm



P114-SL

	L		
30 mm	400 mm	2	P114-SL-40
30 mm	500 mm	2	P114-SL-50
30 mm	600 mm	2	P114-SL-60

Lätt gren sax med aluminiumskänklar för professionellt bruk. Klippkapacitet 35 mm



P116-SL

	L		
35 mm	400 mm	2	P116-SL-40
35 mm	500 mm	2	P116-SL-50
35 mm	600 mm	2	P116-SL-60
35 mm	700 mm	2	P116-SL-70

Lätta och långa grensaxar med aluminiumskänklar för professionellt bruk. Klippkapacitet 55 mm



P280-SL

	L		
55 mm	600 mm	2	P280-SL-60
55 mm	800 mm	2	P280-SL-80

Gren sax med stålhandtag och smitt motskär för professionellt bruk. Klippkapacitet 30 mm



P16

	L		
30 mm	400 mm	2	P16-40
30 mm	500 mm	2	P16-50-F
30 mm	600 mm	2	P16-60-F

Lätta och långa grensaxar med aluminiumskänklar och smitt motskär för professionellt bruk, klippkapacitet: 45 mm



P160-SL

	L		
45 mm	600 mm	2	P160-SL-60
45 mm	750 mm	1	P160-SL-75
45 mm	900 mm	1	P160-SL-90

Röjsax med utväxling och aluminiumskänklar för professionellt bruk



P173-SL

	L		
45 mm	850 mm	1	P173-SL-85



Gren sax med stålhandtag. Klippkapacitet 35 mm



P130-P140

Bladdjup	Längd	Antal	Modell
40 mm	450 mm	6	P130-F
40 mm	660 mm	6	P140-F

Gren sax med tvåkomponentshandtag för proffsbruk, klippkapacitet: 40 mm



PG-18

Bladdjup	Längd	Antal	Modell
40 mm	450 mm	2	PG-18-45-F
40 mm	610 mm	2	PG-18-60-F

Teleskopisk gren sax med tvåkomponentshandtag för proffsbruk, klippkapacitet: 40 mm



PG-19

Bladdjup	Längd	Antal	Modell
40 mm	700-900 mm	2	PG-19-F

Reservskär för grensaxar



R114V/R373A

Bladdjup	Längd	Antal	Modell
P160-SL	28	28	R160A-BULK28
P280-SL-80	25	25	R185V
P14	25	25	R114V
P14	28	28	R114V-BULK28
P280	1	1	R181P
P-SL2, P116-SL	1	1	R16V
P-SL2, P116-SL	14	14	R16V-BULK14
P-SL, P114-SL	8	8	R115V
P-SL, P114-SL	14	14	R115V-BULK14
P172-85, P172-65	1	1	R172A
P16-40W	25	25	R116VP
P16	1	1	R116V
P16	36	36	R116V-BULK36
P19-80	1	1	R119V
P160	1	1	R160A
P173-SL-85	25	25	R373A

Reservmotskär för grensaxar



R214V/R26V/R260A...

Bladdjup	Längd	Antal	Modell
P14	1	1	R214V
P14	28	28	R214V-BULK28
P116-SL	8	8	R216SL
P-SL-40/45/60	1	1	R215V
P114-SL	1	1	R214SL
P160	16	16	R260A
P16*	40	40	R716VCB
P180-70	1	1	R680V
P19-80	1	1	R619V

Buffertar för grensaxar och häcksaxar



R430V-R516V

Bladdjup	Längd	Antal	Modell
P-SL, P-SL2, P114, P116, P52-SL, P54-SL	22	22	R440V

Reservdelssats med mothåll och skruvar för röjsax



R372H

Bladdjup	Längd	Antal	Modell
P172-65 /-85, P172-SL	1	1	R372H

Reservdelssats med centrumbult och mutter för grensax



R312V-R318V/R143PV/R144PV/R146

Bladdjup	Längd	Antal	Modell
P280-SL	12	12	R335V
P16	1	1	R143PV
P16*	1	1	R143PVCB
P160	24	24	R144PV
P14, P174, P176-75	24	24	R146VS
P14, P174, P176-75	50	50	R146VS-BULK50
P114-SL, P116-SL	22	22	R166V
P172-65 /-85	1	1	R312V
P-SL-40 /-45 /-60	1	1	R315V
P280-(SL)	22	22	R328V
P180-70, P19-80, P172	1	1	R318V

Reservdelssats med handtagsbultar och muttrar för grensax



R415V-R775V

Handgrip	Box	Fish
P280-SL	1	R775V
P173-SL-85	1	R776V
P-SL, P-SL2, P114, P116	1	R415V
P19-80	1	R519V
P14, P16	1	R615V
P160	24	R660V
P172-SL	14	R772V
P280-SL-80	1	R773V

Sexkantsskruv för justering av skär/motskär



R272H

Handgrip	Box	Fish
P173-SL-85	30	R472H
P172-65/-85, P172-SL-85	1	R272H

TOPPSAXAR OCH SÅGAR FÖR TELESKOPSKAFT

Teleskopskaft i aluminium



ATP-200

Length (L)	Box	Fish
2000-3520 mm	1	ATP-200-350
2070-5040 mm	1	ATP-200-500

Teleskopskaft i aluminium eller glasfiber



AP-/FP-

Length (L)	Box	Fish
2000-5000 mm	1	AP-5M
2000-3500 mm	1	AP-3M
1800-3200 mm	1	FP-3M

Kompakt teleskopskaft i aluminium



ATP-110-210

Length (L)	Box	Fish
1100-2100 mm	1	ATP-110-210

Sektionsskaft i aluminium



ASP-1850G

Length (L)	Box	Fish
1870 mm	1	ASP-1850G

Förlängningskaft i aluminium



ASP-1850

Length (L)	Box	Fish
1870 mm	1	ASP-1850

Adapter för grensåg



ASP-AS

Length (L)	Box	Fish
135 mm	6	ASP-AS

Adapter för toppsax P34-37/P134/P34-27A-F



ASP-ATP

Length (L)	Weight (g)	Box	Fish
160 mm	100 g	6	ASP-ATP

Adapter för sektions- och teleskopskaft



RAUNI

Length (L)	Weight (g)	Box	Fish
ATP-110-210	82 g	6	RAUNI



Krok med adapter för ASP- och ATP-skaft



ASP-AS-HOOK



325 g



4 ASP-AS-HOOK

Topsaxar på teleskopskaft



ATP-230-410



32 mm 2370-4110 mm 2 ATP-230-410

Reservskär för topsax P34-37



R137E



P34-37



30 R137E

Topsax med trestegsutväxling



P34-37



40 mm



2 P34-37

Topsax med draglina



AP-234

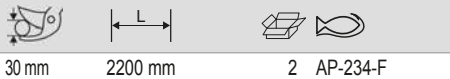

30 mm 2200 mm 2 AP-234-F

Sats med reservblad för teleskopisk topsax ATP-230-410

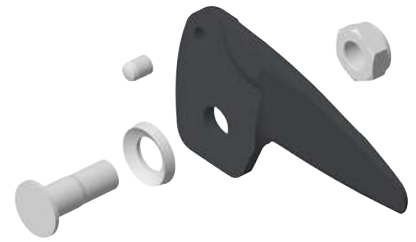

R230P



ATP-230-410



62 g



10 R230P

Topsax med utväxling



P34-27A



30 mm



2 P34-27A-F

Topsaxsats



ASP3740-P

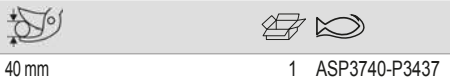

40 mm 1 ASP3740-P3437

Reservfjäder för teleskopisk topsax ATP-230-410



R4230



ATP-230-410



7 g



10 R4230

ASP-1850G	
ASP-1850	
P34-37	
ASP-ATP	
4750-PSTB-1	

Reservgummibuffertar för kort teleskopskaft



RBCP

ATP-110-210	30 g	10	RBCP

Sats med gummibuffert och innerhandtag för teleskopisk toppsax



RBCP230

ATP-230-410	66 g	12	RBCP230

Reservhävarm för ATP-teleskopskaft



RCAM

ATP-200-350 ; ATP-200-500 ; ATP-110-210	29 g	20	RCAM30
ATP-200-500 ; ATP-110-210	37 g	20	RCAM36

Reservlina för skärhuvud



RD1M

ATP-230-410	5 g	15	RD1M

Reservdelssats med centrumskruv och mutter för toppsax P34-37



R142P/R337E

P34-37	1	R337E

Reservlina för skärhuvud till teleskopisk toppsax ATP-230-410



RD7M

ATP-230-410	19 g	20	RD7M

Motskär för toppsaxar



R133PG

P34-27A	1	R133PG

Reservspak för skärhuvud till teleskopisk toppsax ATP-230-410



RPL230G

ATP-230-410	72 g	8	RPL230G

Fjädrar för toppsax P34-27A



R427AE/R427E/R437E

P134, P34-27A P34-37	18 18	R427AE R437E



Beskärningssåg med fin tandning för förlängningskaft



ASP-AS-C F

330 mm	7	5	ASP-AS-C33-JT-F

Beskärningssåg med medelgrov tandning för förlängningskaft



ASP-AS-C M

360 mm	6.2	5	ASP-AS-C36-JT-M

Beskärningssåg med grov tandning för förlängningskaft



ASP-AS-C C

390 mm	5.4	5	ASP-AS-C39-JT-C
450 mm	5.4	2	ASP-AS-C45-JT-C

Beskärningssåg med härdade och filbara tandspetsar med plasthandtag, för förlängningskaft



339-/340-

360 mm	6	4	339-6T
360 mm	6	4	340-6T

Beskärningssåg med härdade och filbara tandspetsar med stålrorshandtag



383-/384-

360 mm	6	4	383-6T
360 mm	6	4	384-6T
360 mm	5	4	384-5T

Beskärningssåg med härdade och filbara tandspetsar med stålrorshandtag och förlängd krokformad spets



385-/386-

360 mm	6	4	385-6T
360 mm	6	4	386-6T

Grensåg med 360 mm medelgrovt tandat blad



ASP3740-C39JTC

1950 mm	2819 g	1	ASP3740-C39JTC

ASP-1850G

ASP-1850

ASP-AS-C36-JT-M

4750-PSTB-1

Grensåg med 390 mm medelgrovt tandat blad



ASP3740-C39JTC

1950 mm	2838 g	1	ASP3740-C39JTC

ASP-1850G

ASP-1850

ASP-AS-C39-JT-C

4750-PSTB-1

Grensåg med 450 mm medelgrovt tandat blad



ASP3740-C45JTC

1950 mm	2863 g	1	ASP3740-C45JTC

ASP-1850G

ASP-1850

ASP-AS-C45-JT-C

4750-PSTB-1

HÄCKSAXAR

Extra kraftig häcksax med stålhandtag



P51

570 mm	25 cm	2	P51-F

Extra kraftig och lätt häcksax med aluminiumskänklar



P51-SL

570 mm	25 cm	2	P51-SL

Lätt precisionshäcksax med aluminiumskänklar



P54-SL

500 mm	18 cm	2	P54-SL-20
550 mm	22,5 cm	2	P54-SL-25

Precisionshäcksax med aluminiumskänklar



PG-56

540 mm	23 cm	2	PG-56-F

Extra kraftig, lång och lätt häcksax med aluminiumskänklar



P51H-SL

730 mm	25 cm	2	P51H-SL

Lång och lätt precisionshäcksax med aluminiumskänklar



P54H-SL

600 mm	18 cm	2	P54H-SL-20
650 mm	22,5 cm	2	P54H-SL-25

Teleskopisk häcksax med aluminiumskänklar för proffsbruk



PG-57-F

800-1050 mm	20 cm	2	PG-57-F

Extra kraftig häcksax med trähandtag



P57-25

540 mm	23 cm	4	P57-25-F
540 mm	23 cm	4	P57-25-W-F

Häcksax med extra hög precision och låg vikt, med handtag av aluminium



P52-SL-20

590 mm	18 cm	2	P52-SL-20

Universalhäcksax med stålhandtag



P59

580 mm	21 cm	6	P59-25-F



Reservbuffertar för häcksaxar



R440V-R516V

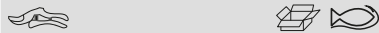

P14, P16, P180-70, P19-80, P160-60, P51	22	R515VS
P160, P160-SL, P280-SL	22	R516V
P53-SL, P54H-SL, P52-SL-20	22	R444V

Reservdelssats med centrumskruv, mutter och låsring för häcksax



R146VC/R147V

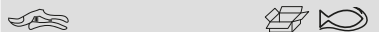

P51, P51H, P52, P53, P54, P52-SL-20	22	R146VC
P55, P57	24	R147V

GRÄSSAXAR

Grässax med plasthandtag, ställbart i tre lägen



GS-76

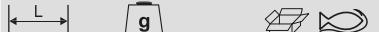

355 mm	435 g	8	GS-76
--------	-------	---	-------

Grässax med vridbart huvud



GS-180

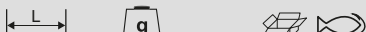

375 mm	317 g	6	GS-180-F
--------	-------	---	----------

Lång grässax med plasthandtag, 1 100 mm



P74

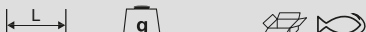

1100 mm	2000 g	1	P74
---------	--------	---	-----

Grässax med plasthandtag.



P75



1000 mm	1900 g	1	P75
---------	--------	---	-----

TRÄDGÅRDSKNIVAR

Hopfällbar okulerkniv med plasthandtag



P11

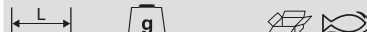

180 mm	70 g	6	P11
--------	------	---	-----

Hopfällbar beskärningskniv med plasthandtag



P20

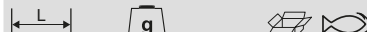

190 mm	100 g	6	P20
--------	-------	---	-----

Hopfällbar beskärningskniv med handtag i rostfritt stål



K-AP-1

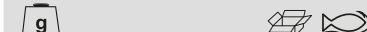

90 g	10	K-AP-1
------	----	--------

Krokformad hopfällbar beskärningskniv med handtag i rostfritt stål



K-GP-1

90 g	10	K-GP-1

SAXAR

Blomstersax med mjukt greppvänligt handtag – liten



FS-5

10	FS-5

Blomstersax med mjukt greppvänligt handtag – medium



FS-8

10	FS-8

Blomstersax med mjukt greppvänligt handtag – stor



FS-7.5

10	FS-7.5

BÅGSÅGAR

ERGO™ kraftiga bågsågar för proffs 21–30"



10

530 mm	21 in	5	10-21-51
607 mm	24 in	5	10-24-23
607 mm	24 in	5	10-24-51
759 mm	30 in	5	10-30-23
759 mm	30 in	5	10-30-51

ERGO™ extra kraftiga bågsågar för proffs 21" med spetsig framdel



332

530 mm	21 in	5	332-21-51

Bågsågar, 21 till 36 tum



SE -15/-16

530 mm	21 in	5	SE-16-21
530 mm	21 in	5	SE-16-21-23
607 mm	24 in	5	SE-15-24
759 mm	30 in	5	SE-15-30
759 mm	30 in	5	SE-15-30-23
810 mm	32 in	5	SE-15-32
912 mm	36 in	5	SE-15-36
912 mm	36 in	5	SE-15-36-23

Små bågsågar på 21" för torrt trä



331-21

530 mm	21 in	5	331-21-51-KP

Spetsig bågsåg för levande trä, 15"



331-15

378 mm	15 in	5	331-15-23



Universalbågsågar med vändbart blad, 24"



3-24-51



607 mm 24 in 5 3-24-51

Universalbågsågar med vändbart blad, 21"



2-21-51



530 mm 21 in 5 2-21-51

Bågsåg med vändbart blad, 14"



333



350 mm 14 in 5 333

Bågsåg för ventilationsrör, 24"



14-24



607 mm 24 in 5 14-24-3810

Liten bågsåg för verktyglådan



9-12



320 mm 12 in 5 9-12-51/3806-KP

Reservblad för bågsåg 12-36" för torrt trä



51

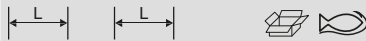

320 mm	12-1/2 in	10	51-12
530 mm	20.75 in	10	51-21
607 mm	24 in	10	51-24
759 mm	30 in	10	51-30
810 mm	28.57 in	10	51-32
912 mm	36 in	10	51-36

Reservblad för bågsåg 15-36" för färskt trä



23

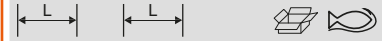

378 mm	13.33 in	10	23-15
530 mm	20.75 in	10	23-21
607 mm	24 in	10	23-24
759 mm	30 in	10	23-30
810 mm	28.57 in	10	23-32
912 mm	36 in	10	23-36

Fint peg-tandat blad för bågsåg, 14"



333-5

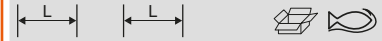

350 mm 13-3/4 in 10 333-5

BESKÄRNINGSSÅGAR

Tandade beskärningssågar med lågfriktionsblad



349



300 mm 7 4 349

Hopfällbar grensåg med lågfriktionsblad



PG-72

190 mm	7	4	PG-72

Hopfällbar grensåg med tvåkomponentshandtag för vinterbeskäring



396-JT

190 mm	7	4	396-JT

Beskärningsåg med tvåkomponentshandtag och hölster för sågning av färska grenar



51-JS

240 mm	5	4	5124-JS-H
280 mm	5	4	5128-JS-H

Hopfällbar grensåg med tvåkomponentshandtag för sågning av torrt trä, plast eller ben



396-LAP

190 mm	200 g	10	396-LAP
190 mm	44 g	100	396-BLADE
190 mm	44 g	1	396-BLADE-1P

Hopfällbar grensåg med tvåkomponentshandtag för sågning av hårt/torrt trä



396-HP

190 mm	7	4	396-HP

Grensåg med tvåkomponentshandtag och hölster för vinterbeskäring



41-JT

240 mm	7	4	4124-JT-H
280 mm	7	4	4128-JT-H

Hopfällbar grensåg med tvåkomponentshandtag för sågning av färska grenar



396-JS

190 mm	5	4	396-JS

4211 med tandspetsjärdat blad och 4212 med filbart tandat blad, med trähandtag



4211-4212-

280 mm	6	4	4211-11-6T
360 mm	6	4	4211-14-6T
280 mm	6	4	4212-11-6T
360 mm	6	4	4212-14-6T

Sats med hopfällbar såg och kniv med tvåkomponentshandtag



LAP-KNIFE

329 g	10	LAP-KNIFE

396-LAP

2444-LAP



Blad för grensåg 51-JS



5724-JS/5728-JS

240 mm	5	1	5724-JS
280 mm	5	1	5728-JS

Blad för grensåg 41-JT



4724-JT/4728-JT

240 mm	7	1	4724-JT
280 mm	7	1	4728-JT

Blad för grensåg 396-JS



396-JS-BLADE

190 mm	5	300	396-JS-BLADE

Reservblad för grensåg 396-JT



396-JT-BLADE

190 mm	7	300	396-JT-BLADE

Reservblad för grensåg 396-HP



396-HP-BLADE

190 mm	7	300	396-HP-BLADE

Blad för grensåg 4211/4212/339/340



4400-/4420-

280 mm	6	10	4400-11
360 mm	6	10	4400-14
280 mm	6	10	4420-11
360 mm	6	10	4420-14
280 mm	6	10	4400-11-BULK
360 mm	6	10	4400-14-BULK
280 mm	6	10	4420-11-BULK
360 mm	6	10	4420-14-BULK

RESERVDELAR OCH TILLBEHÖR

Böjt fintandat blad för grensågar



AS-F-BLADE

330 mm	7	15	AS-C33-JT-F

Böjt medelgrovt tandat blad för grensågar



AS-M-BLADE

360 mm	6.2	15	AS-C36-JT-M

Böjt grovtandat blad för grensågar



AS-C-C-BLADE

390 mm	5.4	15	AS-C39-JT-C
450 mm	5.4	15	AS-C45-JT-C

Förvaringsväska för förlängningskaft



4750-PSTB-1

1910 mm	1040 g	1	4750-PSTB-1

TILLBEHÖR OCH UNDERHÅLL

Syntetiskt bryne, grovlek 180/400



LS-COMBINESS



100 mm



1 LS-COMBINESS

Syntetiskt bryne, grovlek 320



LS-CORINDON



100 mm



1 LS-PIERRE CORINDON

Skärpstål av hårdmetall och tvåkomponentshandtag



SHARP-X



100 mm

100 mm



10 SHARP-X
1 SHARP-X-DISP

Syntetiskt bryne, kornstorlek 180



LS-PIERRE-FAUX



230 mm



1 LS-PIERRE-FAUX

Syntetiskt bryne av Carbor-typ, kornstorlek 220



LS-6160-23



230 mm



1 LS-6160-23

Smörjmedel, 50 ml sprayflaska



LUB-2015



60 g



6 LUB-2015

Sekatörhölster i läder



PROF-H



86 g



2 PROF-H

Nylonhölster för grensax



PROF-LOPP



390 g



1 PROF-LOPP

Sekatörhölster i nylon



PROF-SEC



150 g



1 PROF-SEC



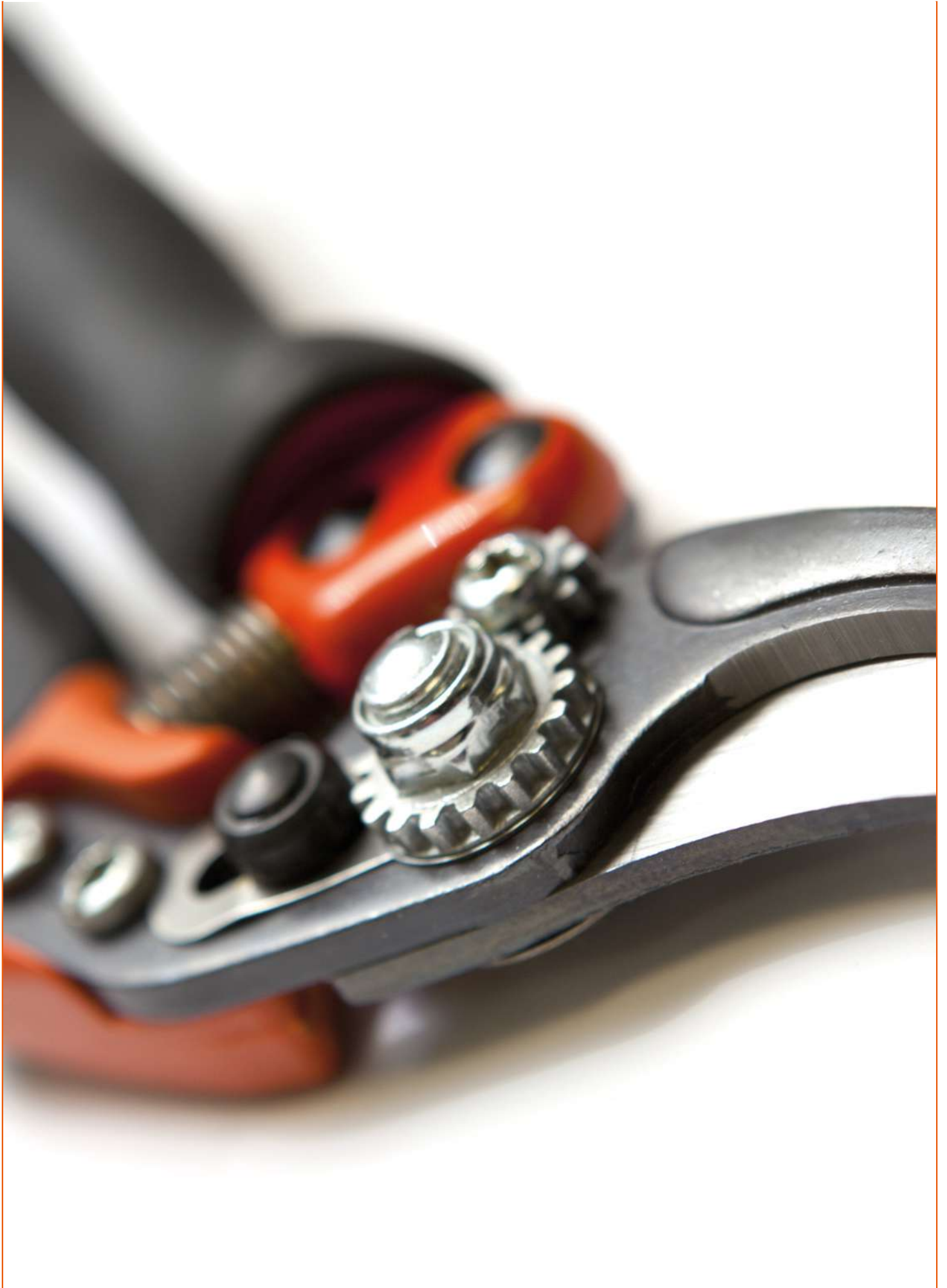

BAHCO



Tryckluftsverktyg för utomhusbruk



SEKATÖRER

Tryckluftsdreven sekator med ett skär och motskär för professionell användning



9210



30 mm



1 9210

Förpackning med olika O-ringar för 9210 tryckluftsdreven sekator



9210-20



9210

28 g



1 9210-20

Kolvskivor för 9210 tryckluftsdreven sekator



9210-1690148



9210

22 g

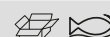

1 9210-1690148

Reservskär och nitar för 9210 tryckluftsdreven sekator



9210-1



9210



82 g



1 9210-1

Mässingshylsor för 9210 tryckluftsdreven sekator – 10 st.



9210-1720100



9210

55.3 g



1 9210-1720100

Stötdämpare för 9210 tryckluftsdreven sekator



9210-1730107



9210

176 g



10 9210-1730107

Kompleta hopmonterade skärhuvuden för 9210 tryckluftsdreven sekator



9210-10



9210



212 g



1 9210-10

Kolvförsegling för 9210 tryckluftsdreven sekator



9210-1230235



9210

6.7 g



1 9210-1230235

Returfjädrar för 9210 tryckluftsdreven sekator



9210-1640142



9210

26.6 g



1 9210-1640142

Kopplingsstänger för 9210 tryckluftdriven sekator



9210-1700118

9210	41 g	1	9210-1700118

TSP 2,2 mm x 6,5 mm självdragande skruvar för 9210 tryckluftdriven sekator



9210-1060238

9210	10 g	20	9210-1060238

TCCE M6 x 20 mm skruvar för 9210 tryckluftdriven sekator



9210-1060177

9210	7 g	1	9210-1060177

Specialnitar för 9210 tryckluftdriven sekator



9210-1770106

9210	1000 g	10	9210-1770106

Frontskydd för 9210 tryckluftdriven sekator



9210-1830137

9210	9.5 g	1	9210-1830137

Handskydd för 9210 tryckluftdriven sekator



9210-1320281

9210	35 g	10	9210-1320281

Dammskyddsförseglingar för 9210 tryckluftdriven sekator



9210-1230219

9210	8.6 g	20	9210-1230219

Maskinhus med mässingscylinder för 9210 tryckluftdriven sekator



9210-1710266

9210	193 g	1	9210-1710266





BAHCO



1-100-04-1-0	7311518019006	10	22
1-100-04-1-2	7311518244125	5	22
1-100-04-2-0	7311518019013	10	22
1-100-04-2-2	7311518244132	5	22
1-100-04-3-0	7311518019020	10	22
1-100-06-1-0	7311518019037	10	22
1-100-06-1-2	7311518000233	5	22
1-100-06-2-0	7311518019044	10	22
1-100-06-2-2	7311518003593	5	22
1-100-06-3-0	7311518019051	10	22
1-100-06-3-2	7311518293581	5	22
1-100-08-1-0	7311518019068	10	22
1-100-08-1-2	7311518000264	5	22
1-100-08-2-0	7311518019075	10	22
1-100-08-2-2	7311518003609	5	22
1-100-08-3-0	7311518019082	10	22
1-100-08-3-2	7311518295585	5	22
1-100-10-1-0	7311518019099	10	22
1-100-10-1-2	7311518000295	5	22
1-100-10-2-0	7311518019105	10	22
1-100-10-2-2	7311518003616	5	22
1-100-10-3-0	7311518019112	10	22
1-100-10-3-2	7311518295592	5	22
1-100-12-1-0	7311518019129	5	22
1-100-12-1-2	7311518028053	5	22
1-100-12-2-0	7311518019136	5	22
1-100-12-2-2	7311518244118	5	22
1-100-12-3-0	7311518019143	5	22
1-100-12-3-2	7311518295608	5	22
1-100-14-1-0	7311518019150	5	22
1-100-14-2-0	7311518019167	5	22
1-102-06-2-0	7311518019198	10	22
1-102-06-3-0	7311518019204	10	22
1-102-08-1-0	7311518019211	10	22
1-102-08-2-0	7311518019228	10	22
1-102-08-3-0	7311518019235	10	22
1-104-10-2-0	7311518019242	10	22
1-104-10-3-0	7311518019259	10	22
1-104-12-2-0	7311518019266	5	22
1-104-12-3-0	7311518019273	5	22
1-104-14-3-0	7311518019297	5	22
1-106-08-1-0	7311518019303	10	22
1-106-08-1-2	7311518000301	5	22
1-106-10-1-0	7311518019310	10	22
1-106-10-1-2	7311518000325	5	22
1-106-12-1-0	7311518019327	5	22
1-106-12-1-2	7311518295615	5	22
1-110-04-1-0	7311518019334	10	22
1-110-04-2-0	7311518019341	10	22
1-110-04-3-0	7311518044046	10	22
1-110-06-1-0	7311518019358	10	22
1-110-06-1-2	7311518295622	5	23
1-110-06-2-0	7311518019365	10	22
1-110-06-2-2	7311518003623	5	23
1-110-06-3-0	7311518019372	10	22
1-110-06-3-2	7311518295639	5	23
1-110-08-1-0	7311518019389	10	22
1-110-08-1-2	7311518000332	5	23
1-110-08-2-0	7311518019396	10	22
1-110-08-2-2	7311518003630	5	23
1-110-08-3-0	7311518019402	10	22
1-110-08-3-2	7311518295646	5	23
1-110-10-1-0	7311518019419	10	22
1-110-10-1-2	7311518000349	5	23
1-110-10-2-0	7311518019426	10	22
1-110-10-2-2	7311518003647	5	23
1-110-10-3-0	7311518019433	10	22
1-110-10-3-2	7311518295653	5	23
1-110-12-1-0	7311518019440	5	22
1-110-12-1-2	7311518295660	5	23
1-110-12-2-0	7311518019457	5	22
1-110-12-2-2	7311518295677	5	23
1-110-12-3-0	7311518019464	5	22
1-110-12-3-2	7311518295684	5	23
1-110-14-1-0	7311518019488	5	22
1-111-04-1-0	7311518044053	10	23
1-111-04-2-0	7311518019518	10	23
1-111-04-3-0	7311518019525	10	23
1-111-06-1-0	7311518019549	10	23
1-111-06-2-0	7311518019556	10	23
1-111-06-2-2	7311518000363	5	23
1-111-06-3-0	7311518019563	10	23
1-111-08-1-0	7311518019570	10	23
1-111-08-2-0	7311518019587	10	23
1-115-11-3-1	7311518003791	10	23
1-143-04-1-0	7311518105983	10	23
1-143-06-1-0	7311518019631	10	23
1-143-06-1-2	7311518022341	5	23
1-143-08-1-0	7311518019662	10	23
1-143-08-1-2	7311518028077	5	23
1-143-10-1-0	7311518019693	10	23
1-143-10-1-2	7311518022358	5	23
1-143-12-1-0	7311518019723	5	23
1-143-12-1-2	7311518295691	5	23
1-160-04-1-0	7311518019785	10	25
1-160-04-1-2	7311518244057	5	25



1-160-04-2-0	7311518019792	10	25
1-160-04-2-2	7311518244095	5	25
1-160-04-3-0	7311518019808	10	25
1-160-06-1-0	7311518019815	10	25
1-160-06-1-2	7311518000370	5	25
1-160-06-2-0	7311518019822	10	25
1-160-06-2-2	7311518003685	5	25
1-160-06-3-0	7311518019839	10	25
1-160-06-3-2	7311518295707	5	25
1-160-08-1-0	7311518019846	10	25
1-160-08-1-2	7311518000394	5	25
1-160-08-2-0	7311518019853	10	25
1-160-08-2-2	7311518003692	5	25
1-160-08-3-0	7311518019860	10	25
1-160-08-3-2	7311518295714	5	25
1-160-10-1-0	7311518019877	10	25
1-160-10-1-2	7311518000400	5	25
1-160-10-2-0	7311518019884	10	25
1-160-10-2-2	7311518295721	5	25
1-160-10-3-0	7311518019891	10	25
1-160-10-3-2	7311518295738	5	25
1-160-12-1-0	7311518019907	5	25
1-160-12-1-2	7311518295745	5	25
1-160-12-2-0	7311518019914	5	25
1-160-12-2-2	7311518295752	5	25
1-160-12-3-0	7314150292059	5	25
1-160-12-3-2	7311518298005	5	25
1-170-04-1-0	7311518044060	10	24
1-170-04-2-0	7311518019945	10	24
1-170-04-2-2	7311518244088	5	24
1-170-04-3-0	7311518019952	10	24
1-170-06-1-0	7311518019969	10	24
1-170-06-1-2	7311518244071	5	24
1-170-06-2-0	7311518019976	10	24
1-170-06-2-2	7311518003715	5	24
1-170-06-3-0	7311518019983	10	24
1-170-06-3-2	7311518295769	5	24
1-170-08-1-0	7311518019990	10	24
1-170-08-1-2	7311518000417	5	24
1-170-08-2-0	7311518020002	10	24
1-170-08-2-2	7311518003722	5	24
1-170-08-3-0	7311518020019	10	24
1-170-08-3-2	7311518295783	5	24
1-170-10-1-0	7311518020026	10	24
1-170-10-1-2	7311518028107	5	24
1-170-10-2-0	7311518020033	10	24
1-170-10-2-2	7311518244064	5	24
1-170-10-3-0	7311518020040	10	24
1-170-10-3-2	7311518295806	5	24
1-170-12-1-0	7311518020057	5	24
1-170-12-2-0	7311518020064	5	24
1-210-04-1-0	7311518020071	10	24
1-210-04-1-2	7311518243944	5	24
1-210-04-2-0	7311518020088	10	24
1-210-04-2-2	7311518244040	5	24
1-210-04-3-0	7311518020095	10	24
1-210-06-1-0	7311518020101	10	24
1-210-06-1-2	7311518000424	5	24
1-210-06-2-0	7311518020118	10	24
1-210-06-2-2	7311518003654	5	24
1-210-06-3-0	7311518020125	10	24
1-210-06-3-2	7311518293574	5	24
1-210-08-1-0	7311518020132	10	24
1-210-08-1-2	7311518000455	5	24
1-210-08-2-0	7311518020149	10	24
1-210-08-2-2	7311518000479	5	24
1-210-08-3-0	7311518020156	10	24
1-210-08-3-2	7311518295837	5	24
1-210-10-1-0	7311518020163	10	24
1-210-10-1-2	7311518000493	5	24
1-210-10-2-0	7311518020170	10	24
1-210-10-2-2	7311518003661	5	24
1-210-10-3-0	7311518020187	10	24
1-210-10-3-2	7311518295844	5	24
1-210-12-1-0	7311518020194	5	24
1-210-12-1-2	7311518028121	5	24
1-210-12-2-0	7311518020200	5	24
1-210-12-2-2	7311518244149	5	24
1-210-12-3-0	7311518020217	5	24
1-210-12-3-2	7311518295851	5	24
1-210-14-1-0	7311518020224	5	24
1-230-04-1-0	7311518020248	10	24
1-230-04-1-2	7311518244163	5	24
1-230-04-2-0	7311518020255	10	24
1-230-04-2-2	7311518244156	5	24
1-230-04-3-0	7311518020262	10	24
1-230-06-1-0	7311518020279	10	24
1-230-06-1-2	7311518000509	5	24
1-230-06-2-0	7311518020286	10	24
1-230-06-2-2	7311518000523	5	24
1-230-06-3-0	7311518020293	10	24
1-230-06-3-2	7311518293567	5	24
1-230-08-1-0	7311518020309	10	24
1-230-08-1-2	7311518000547	5	24
1-230-08-2-0	7311518020316	10	24
1-230-08-2-2	7311518000554	5	24













1-230-08-3-0	7311518020323	10	24
1-230-08-3-2	7311518295882	5	24
1-230-10-1-0	7311518020330	10	24
1-230-10-1-2	7311518000578	5	24
1-230-10-2-0	7311518020347	10	24
1-230-10-2-2	7311518003678	5	24
1-230-10-3-0	7311518020354	10	24
1-230-10-3-2	7311518295899	5	24
1-230-12-1-0	7311518020361	5	24
1-230-12-1-2	7311518295912	5	24
1-230-12-2-0	7311518020378	5	24
1-230-12-2-2	7311518295929	5	24
1-230-12-3-0	7311518020385	5	24
1-230-12-3-2	7311518295905	5	24
1-320-08-2-0	7311518191276	10	23
1-320-08-2-2	7311518270865	5	23
1-320-10-2-0	7311518020477	10	23
1-320-10-2-2	7311518270872	5	23
1-320-12-2-0	7311518020484	5	23
1-320-12-2-2	7311518270889	5	23
1-473-06-2-2	7311518201098	5	25
1-473-08-2-2	7311518201104	5	25
1-473-10-2-2	7311518201111	5	25
1-476-04-3-2	7311518010928	1	25
1-477-08-2-2	7311518037994	5	25
1-477-10-2-2	7311518201074	5	26
1-478-08-1-2	7311518141127	5	26
1-478-10-1-2	7311518241995	5	26
1-479-08-1-2	7311518176747	5	26
1-479-08-2-2	7311518180607	5	26
10-21-51	7311518229344	5	647
10-24-23	7311518229368	5	647
10-24-51	7311518229351	5	647
10-30-23	7311518229382	5	647
10-30-51	7311518229375	5	647
1016	7314150218189	10	217
1019	8412814010199	10	217
1031-10	7314150025442	5	585
1031-12	7314150025459	5	585
1031-14	7314150025466	5	585
1031-16	7314150025473	5	585
1031-18	7314150025480	5	585
1031-20	7314150025497	5	585
1031-22	7314150025503	5	585
1031-25	7314150025510	5	585
1031-28	7314150025527	5	585
1031-30	7314150025534	5	585
1031-32	7314150025541	5	585
1031-4	7314150025411	5	585
1031-40	7314150025558	5	585
1031-6	7314150025428	5	585
1031-8	7314150025435	5	585
1067	8412814010670	10	217
1084	7311518277291	5	270
1084-KIT	7314150336944	1	271
10RM-10	7314153014351	1	45
10RM-13	7314153014368	1	45
10RM-14	7314150221677	1	45
10RM-17	7314153014375	1	45
10RM-19	7314153014382	1	45
10RM-8	7314153014344	1	45
10RM/SH6	7314150222971	1	46
10RZ-1/2	7314150358786	1	45
10RZ-11/16	7314150358816	1	45
10RZ-3/4	7314150358823	1	45
10RZ-3/8	7314150358762	1	45
10RZ-5/16	7314150358748	1	45
10RZ-5/8	7314150358809	1	45
10RZ-7/16	7314150358779	1	45
10RZ-9/16	7314150358793	1	45
111M-10	7314151828653	10	40
111M-100	7314150401499	1	40
111M-11	7314151828660	10	40
111M-12	7314151828677	10	40
111M-13	7314151828684	10	40
111M-14	7314151828691	10	40
111M-15	7314151828707	10	40
111M-16	7314151828714	10	40
111M-17	7314151828721	10	40
111M-18	7314151828738	10	40
111M-19	7314151828745	10	40
111M-20	7314151828752	10	40
111M-21	7314151828769	10	40
111M-22	7314151828776	5	40
111M-23	7314151828783	5	40
111M-24	7314151828790	5	40
111M-25	7314151828806	5	40
111M-26	7314151828813	5	40
111M-27	7314151828820	5	40
111M-28	7314151828837	5	40
111M-29	7314151828844	5	40
111M-30	7314151828851	5	40
111M-32	7314151828868	5	40
111M-33	7314150222223	5	40
111M-34	7314151828875	5	40
111M-36	7314150135516	1	40



111M-38	7314150222230	1	40
111M-41	7314150135523	1	40
111M-46	7314150135530	1	40
111M-5.5	7314151828608	10	40
111M-50	7314150135547	1	40
111M-55	7314150135554	1	40
111M-6	7314151828615	10	40
111M-60	7314150135561	1	40
111M-65	7314150135578	1	40
111M-7	7314151828622	10	40
111M-70	7314150135585	1	40
111M-75	7314150135592	1	40
111M-8	7314151828639	10	40
111M-80	7314150135608	1	40
111M-85	7314150352999	1	40
111M-9	7314151828646	10	40
111M-90	7314150401475	1	40
111M-95	7314150401482	1	40
111M/11T	7314151828899	1	42
111M/14T	7314151828905	1	42
111M/17T	7314151828912	1	42
111M/17TL	7314150197859	1	42
111M/24T	7314150197866	1	42
111M/26T	7314151828929	1	42
111M/S10	7314150212965	1	42
111M/SH12	7314153013347	1	41
111M/SH5	7314150325252	1	41
111M/SH8	7314150197873	1	41
111Z-1	7314151829063	3	41
111Z-1.1/16	7314151829070	5	41
111Z-1.1/2	7314150135752	1	41
111Z-1.1/4	7314151829094	5	41
111Z-1.1/8	7314151829087	5	41
111Z-1.11/16	7314150135615	1	41
111Z-1.13/16	7314150135639	1	41
111Z-1.3/4	7314150135622	1	41
111Z-1.3/8	7314150135738	1	41
111Z-1.5/16	7314151829100	5	41
111Z-1.5/8	7314150135769	1	41
111Z-1.7/16	7314150135745	1	41
111Z-1.7/8	7314150135646	1	41
111Z-1/2	7314151828981	5	41
111Z-1/4	7314151828943	5	41
111Z-11/16	7314151829018	5	41
111Z-13/16	7314151829032	5	41
111Z-15/16	7314151829056	3	41
111Z-2	7314150135653	1	41
111Z-2.1/2	7314150135721	1	41
111Z-2.1/4	7314150135691	1	41
111Z-2.1/8	7314150135677	1	41
111Z-2.3/4	7314150135783	1	41
111Z-2.3/8	7314150135707	1	41
111Z-2.5/8	7314150135776	1	41
111Z-2.7/8	7314150135790	1	41
111Z-3	7314150135806	1	41
111Z-3/4	7314151829025	5	41
111Z-3/8	7314151828967	5	41
111Z-5/16	7314151828950	5	41
111Z-5/8	7314151829001	5	41
111Z-7/16	7314151828974	5	41
111Z-7/8	7314151829049	5	41
111Z-9/16	7314151828998	5	41
111Z/11T	7314151829124	1	43
111Z/8T	7314151829117	1	42
1150-1/2H/P	7314150129263	1	559
1150D	7311518276614	1	559
1154	7314150249831	1	326
1154-DG	7314150249800	1	326
1154-MB	7314150249817	1	326
1157	7311518277031	60	620
1162N-1/2	7314151847241	1	552
1177-SCRIBE	7314150120550	5	557
1178-SCRIBE	7314150120567	5	557
1179-FLX	7311518276997	25	557
1179-SCRIBE	7314150120574	5	557
1179-TIPS	7314150120581	1	557
11M-10	7314151829155	5	43
11M-11	7314151829162	5	43
11M-12	7314151829179	5	43
11M-13	7314151829186	5	43
11M-14	7314151829193	5	43
11M-15	7314151829209	5	43
11M-16	7314151829216	5	43
11M-17	7314151829223	5	43
11M-18	7314151829230	5	43
11M-19	7314151829247	5	43
11M-21	7314151829254	5	43
11M-22	7314151829261	5	43
11M-24	7314151829278	5	43
11M-27	7314151829285	1	43
11M-30	7314151829292	1	43
11M-32	7314151829308	1	43
11M-36	7314151829315	1	43
11M-38	7314151829322	1	43
11M-8	7314151829131	5	43
11M-9	7314151829148	5	43

   			
11Z-1	7314150355303	5	43
11Z-1/2	7314150355235	5	43
11Z-11/16	7314150355266	5	43
11Z-13/16	7314150355280	5	43
11Z-3/4	7314150355273	5	43
11Z-3/8	7314150355211	5	43
11Z-5/8	7314150355259	5	43
11Z-7/16	7314150355228	5	43
11Z-9/16	7314150355242	5	43
1300Z-1-1.1/8	7314153000989	1	52
1300Z-1/4-5/16	7314153000965	1	52
1300Z-15/16-1	7314153005656	1	52
1300Z-19/32-11/16	7314151040000	1	52
1300Z-25/32-13/16	7314153000972	1	52
1300Z-3/8-7/16	7314151039981	1	52
1300Z-5/8-3/4	7314151040017	1	52
1300Z-7/8-15/16	7314153005649	1	52
1320RM-10-11	7314153014511	1	47
1320RM-12-13	7314153014528	1	47
1320RM-14-15	7314153014535	1	47
1320RM-16-17	7314153014542	1	47
1320RM-17-19	7314150359196	1	47
1320RM-18-19	7314153014559	1	47
1320RM-22-24	7314150221646	1	47
1320RM-6-7	7314153014498	1	47
1320RM-8-9	7314153014504	1	47
1320RM/SH8	7314150222988	1	47
1320RZ-1/2-9/16	7314153014580	1	47
1320RZ-1/4-5/16	7314153014566	1	47
1320RZ-3/4-13/16	7314150359264	1	47
1320RZ-3/4-7/8	7314150359271	1	47
1320RZ-3/8-7/16	7314153014573	1	47
1320RZ-5/16-11/32	7314153015235	60	47
1320RZ-5/8-11/16	7314150359257	1	47
1320RZ-7/8-15/16	7314150359288	1	47
1320SRM-14-19	7314150190355	1	47
1320SRM/S29	7314150188673	1	47
1321RZ-1/2-9/16	7314150359349	1	47
1321RZ-3/4-7/8	7314150359363	1	47
1321RZ-3/8-7/16	7314150359332	1	47
1321RZ-5/8-11/16	7314150359356	1	47
133SGM-100	7314151828523	1	55
133SGM-105	7314151828530	1	55
133SGM-110	7314151828547	1	55
133SGM-115	7314151828554	1	55
133SGM-120	7314151828561	1	55
133SGM-27	7314151828363	1	55
133SGM-30	7314151828370	1	55
133SGM-32	7314151828387	1	55
133SGM-36	7314151828394	1	55
133SGM-41	7314151828400	1	55
133SGM-46	7314151828417	1	55
133SGM-50	7314151828424	1	55
133SGM-55	7314151828431	1	55
133SGM-60	7314151828448	1	55
133SGM-65	7314151828455	1	55
133SGM-70	7314151828462	1	55
133SGM-75	7314151828479	1	55
133SGM-80	7314151828486	1	55
133SGM-85	7314151828493	1	55
133SGM-90	7314151828509	1	55
133SGM-95	7314151828516	1	55
14-24-3810	7311518002879	5	648
140	7314150008797	1	266
141	7314150008827	1	266
1410	7314150106332	1	266
1410D	7314150452842	1	266
1418-4	7314150510863	1	372
1418-5	7314150510870	1	372
1418-6	7314150510887	1	372
1418-7.5	7314150510894	1	372
1418-8.5	7314150510900	1	372
1418S	7314151040604	1	372
1419-M12	7314150257423	1	371
1419-M16	7314150358045	1	371
1419-M5	7314150257409	1	371
1419-M8	7314150257416	1	371
1419-MD	7311518277352	1	343
1419/4	7314150125036	1	371
142	7314150008841	1	266
1420	7314150103744	1	266
1420-1.4	7314151696337	1	371
1420D	7314150452859	1	266
1421-2.1	7314151696412	1	371
1422-3.1	7314151696689	1	371
1423-4.8	7314151696764	1	371
1424-6.2	7314151696849	1	371
143	7314150008872	1	266
1430FT120	7314150342006	1	384
1435/5	7314151040734	1	371
1435/8	7314151040741	1	371
144	7314150008902	1	266
1446	7314150128631	15	599
1446-CS	7314150508266	15	599
1446-FLOAT	7314150438464	15	599
1446-OV	7314150313679	15	599

   			
1450D-ISO	7314151040970	1	374
1450D-VVV	7314151040987	1	374
1450D/2	7314151040963	1	374
1460M/1	7314151041090	1	373
1460M/2	7314151041106	1	374
1460Z/2	7314151041120	1	374
1467-250	7314150124268	1	263
1467-320-850	7314150178636	1	263
1467-520	7314150124275	1	263
1467-B14	7314150301645	1	263
1467-L3.2	7314150209071	1	263
1467-L4	7314150209057	1	263
1467-L5	7314150209040	1	263
1467-L6	7314150209064	1	263
1467-L6.4	7314150209088	1	263
1467-LJ	7314150209033	1	263
1467-S2.4	7314150209026	1	263
1467-S3.2	7314150209019	1	263
1467-S4	7314150209002	1	263
1467-S5	7314150208999	1	263
1467-SJ	7314150208982	1	263
1468-10-1	7314150342471	1	350
1468-10M10	7314150243457	1	349
1468-10M4	7314150243419	1	349
1468-10M5	7314150243426	1	349
1468-10M6	7314150243433	1	349
1468-10M8	7314150243440	1	349
1468-6M3	7314150243372	1	349
1468-6M4	7314150243389	1	349
1468-6M5	7314150243396	1	349
1468-6M6	7314150243402	1	349
1468-M10	7314150243228	1	349
1468-M6	7314150243211	1	349
147	7314150008933	1	266
147-1	7314150367047	1	119
147-1.1/4	7314150367061	1	119
147-1.1/8	7314150367054	1	119
147-1/2	7314150366965	1	119
147-11/16	7314150366996	1	119
147-13	7314150366644	1	118
147-13/16	7314150367016	1	119
147-14	7314150366651	1	118
147-15	7314150366668	1	118
147-15/16	7314150367030	1	119
147-16	7314150366675	1	118
147-17	7314150366682	1	118
147-18	7314150366699	1	118
147-19	7314150366705	1	118
147-21	7314150366712	1	118
147-22	7314150366729	1	118
147-24	7314150366736	1	118
147-25	7314150366743	1	118
147-27	7314150366750	1	118
147-3/4	7314150367009	1	119
147-30	7314150366767	1	118
147-32	7314150366774	1	118
147-33	7314150366781	1	118
147-34	7314150366798	1	118
147-35	7314150366804	1	118
147-36	7314150366811	1	118
147-37	7314150366828	1	118
147-38	7314150366835	1	118
147-39	7314150366842	1	118
147-41	7314150366859	1	118
147-45	7314150366866	1	118
147-46	7314150366873	1	119
147-5/8	7314150366989	1	119
147-50	7314150366880	1	119
147-55	7314150366897	1	119
147-60	7314150366903	1	119
147-68	7314150366910	1	119
147-7/16	7314150366958	1	119
147-7/8	7314150367023	1	119
147-70	7314150366927	1	119
147-75	7314150366934	1	119
147-9/16	7314150366972	1	119
147-90	7314150366941	1	119
1470K-AC1	7314150226498	1	382
1470K-AC2	7314150226504	1	382
1470K-AC3	7314150226511	1	382
1470K-AC4	7314150226528	1	382
1470K-AC7	7314150271320	1	382
1470K-AC8	7314150328581	1	383
1470K-AC8GR	7314150328598	1	383
1470K-ACSIDE	7314150226535	1	382
1470K-ACTD	7314150297269	1	383
1470K-ACTSS	7314150297283	1	383
1470K-ACTW	7314150297276	1	383
1470K7LH	7314150360444	1	380
1470K7LHBLUE	7314150407491	1	380
1470K7LHGREY	7314150407767	1	380
1470K7LHRED	7314150407507	1	380
1470K7SS	7314150343287	1	538
1470KAC01	7314150165124	1	383
1470KC2	7314150226696	1	384
1470KC3A	7314150506354	1	384



1470KC5



1470KC5	7314150226665	1	384
1470KC5PC	7314150226672	1	384
1470KCTRAY	7314150226702	1	384
1470KXL-ACTD	7314150297290	1	383
1470KXL-ACTSS	7314150297313	1	383
1470KXL-ACTW	7314150297306	1	383
1470KXLC-TRAY	7314150285549	1	383
1471KXXL12BKTSS	7314150365432	1	381
1472K-ACTD	7314150399345	1	380
1472K-ACTSS	7314150399338	1	380
1472K-ACTW	73141503993152	1	380
1472K5	7314150349463	1	376
1472K5BLACK	7314150349500	1	376
1472K5BLUE	7314150349616	1	376
1472K5GREY	7314150403813	1	376
1472K5RED	7314150349562	1	376
1472K5WHITE	7314150403707	1	376
1472K6	7314150349470	1	376
1472K6BLACK	7314150349531	1	376
1472K6BLUE	7314150349623	1	376
1472K6GREY	7314150403820	1	376
1472K6RED	7314150349579	1	376
1472K6WHITE	7314150399888	1	376
1472K7	7314150349487	1	376
1472K7BLACK	7314150349548	1	376
1472K7BLUE	7314150349630	1	376
1472K7GREY	7314150403837	1	376
1472K7RED	7314150349586	1	376
1472K7WHITE	7314150403714	1	376
1472K8	7314150349494	1	376
1472K8BLACK	7314150349555	1	376
1472K8BLUE	7314150349647	1	377
1472K8GREY	7314150404018	1	377
1472K8RED	7314150349593	1	377
1472K8WHITE	7314150403721	1	377
1475K-ACSIDE	7314150419968	1	383
1475K6	7314150349654	1	380
1475K6BLACK	7314150349685	1	380
1475K6BLUE	7314150349760	1	380
1475K6RED	7314150349715	1	380
1475K7	7314150349661	1	381
1475K7BLACK	7314150349692	1	381
1475K7BLUE	7314150349814	1	381
1475K7RED	7314150349746	1	381
1475K8	7314150349678	1	381
1475K8BLACK	7314150349708	1	381
1475K8BLUE	7314150349821	1	381
1475K8RED	7314150349753	1	381
1475KXL-AC20BK	7314150353903	1	383
1475KXL12	7314150350223	1	381
1475KXL12BLACK	7314150350230	1	381
1475KXL12RED	7314150402731	1	381
1475KXL6	7314150349968	1	381
1475KXL6BLACK	7314150349999	1	381
1475KXL6BLUE	7314150350162	1	381
1475KXL6C	7314150350193	1	381
1475KXL6CBK-FF5	7314150437467	1	435
1475KXL6CBK-FF6	7314150437474	1	435
1475KXL6CBLACK	7314150350209	1	381
1475KXL6RED	7314150350124	1	381
1475KXL7	7314150349975	1	381
1475KXL7BLACK	7314150350070	1	381
1475KXL7BLUE	7314150350179	1	381
1475KXL7RED	7314150350148	1	381
1475KXL7SS	7314150349517	1	538
1475KXL8	7314150349982	1	381
1475KXL8BLACK	7314150350094	1	381
1475KXL8BLUE	7314150350186	1	381
1475KXL8RED	7314150350155	1	381
1475KXXL-ACTSS	7314150459896	1	383
1475KXXL-ACTW	7314150465330	1	383
1475KXXL8CWTSS	7314150400157	1	381
1476KXXL7BK	7314150439935	1	382
1477K-AC10	7314150353163	1	379
1477K-AC11	7314150369874	1	378
1477K-AC12	7314150369195	1	377
1477K-AC13	7314150369218	1	377
1477K-AC14	7314150369225	1	377
1477K-AC15	7314150369249	1	378
1477K-AC16	7314150369256	1	378
1477K-AC17	7314150369270	1	378
1477K-AC18	7314150369287	1	378
1477K-AC19	7314150369676	1	378
1477K-AC20	7314150369683	1	378
1477K-AC21	7314150370412	1	379
1477K-AC22	7314150369706	1	379
1477K-AC23	7314150369867	1	380
1477K-AC24	7314150370429	1	379
1477K-AC25	7314150370436	1	379
1477K-AC26	7314150414864	1	379
1477K-AC28	7314150370481	1	378
1477K-AC29	7314150370498	1	378
1477K-AC30	7314150469949	1	379
1477K-ACTD	7314150370474	1	380
1477K-ACTP	7314150383764	1	380
1477K-ACTSS	7314150370450	1	379



1477K-ACTW	7314150370467	1	379
1477K6	7314150350391	1	376
1477K6BLACK	7314150351091	1	376
1477K6GREY	7314150351138	1	376
1477K6RED	7314150403653	1	376
1477K6WHITE	7314150358137	1	376
1477K7	7314150350407	1	376
1477K7BLACK	7314150351107	1	376
1477K7GREY	7314150351145	1	376
1477K7RED	7314150403660	1	376
1477K7WHITE	7314150358144	1	376
1477K8	7314150350414	1	376
1477K8BLACK	7314150351114	1	376
1477K8GREY	7314150351183	1	376
1477K8RED	7314150403677	1	376
1477K8WHITE	7314150358151	1	376
1477K9	7314150350940	1	376
1477K9BLACK	7314150351121	1	376
1477K9GREY	7314150351190	1	376
1477K9RED	7314150403684	1	376
1477K9WHITE	7314150403691	1	376
148-1	7314150367801	1	120
148-1/2	7314150367726	1	120
148-11/16	7314150367757	1	120
148-13	7314150367559	1	119
148-13/16	7314150367771	1	120
148-14	7314150367566	1	119
148-15	7314150367573	1	119
148-15/16	7314150367795	1	120
148-16	7314150367580	1	119
148-17	7314150367597	1	119
148-18	7314150367603	1	119
148-19	7314150367610	1	119
148-21	7314150367627	1	119
148-22	7314150367634	1	119
148-24	7314150367641	1	119
148-27	7314150367658	1	119
148-28	7314150367665	1	119
148-3/4	7314150367764	1	120
148-30	7314150367672	1	119
148-32	7314150367689	1	119
148-34	7314150367696	1	119
148-36	7314150367702	1	119
148-41	7314150367719	1	119
148-5/8	7314150367740	1	120
148-7/8	7314150367788	1	120
148-9/16	7314150367733	1	120
1482K4	7314150415779	1	377
1482K4BKW	7314150426126	1	377
1482K4BLACK	7314150415786	1	377
1482K4BLUE	7314150415793	1	377
1482K4GREY	7314150415809	1	377
1482K4RED	7314150415816	1	377
1482K4W	7314150425174	1	377
1482K4WHITE	7314150415823	1	377
1482K5W	7314150431274	1	377
1483CART	7314150273256	1	470
1483K2RB	7314150230013	1	470
1483K3RB	7314150230037	1	470
1483KHD3RB	7314150230099	1	470
1483KHD3RB-FF1	7314150233564	1	452
1483KHD3RB-FF2	7314150233571	1	452
1483KHD3RB-FF3	7314150233588	1	437
1483KHD3RB-FF4	7314150233595	1	437
1483KHD3RB-FF5	7314150233601	1	452
1483KHD3RB-FF7	7314150336050	1	452
1483KHD4RB	7314150230105	1	470
1484THD3RB	7314150265435	1	470
1485K4	7314150349838	1	382
1485K4BLACK	7314150349920	1	382
1485K4BLUE	7314150349944	1	382
1485K4RED	7314150349937	1	382
1485KXL4	7314150350247	1	382
1485KXL4BLACK	7314150350346	1	382
1485KXL4BLUE	7314150350360	1	382
1485KXL4RED	7314150350353	1	382
1487K4	7314150351206	1	377
1487K4BKW	7314150426133	1	377
1487K4BLACK	7314150351213	1	377
1487K4GREY	7314150351237	1	377
1487K4W	7314150425181	1	377
1495CD-AC1	7314150296965	1	468
1495CD60	7314150296927	1	468
1495CD60BK	7314150326952	1	468
1495CD60BL	7314150326969	1	468
1495CD60RED	7314150326976	1	468
1495CD60TS1	7314150325627	1	436
1495CD60W	7314150303656	1	468
1495CD60WBK	7314150327713	1	468
1495CD60WBL	7314150327720	1	468
1495CD60WRED	7314150327744	1	468
1495CS-AC1	7314150296910	1	468
1495CS15	7314150296934	1	467
1495CS15BK	7314150326853	1	467
1495CS15BL	7314150326860	1	467
1495CS15RED	7314150326877	1	467



1495CS15TS1	7314150325610	1	436
1495CS18	7314150296941	1	467
1495CS18BK	7314150326884	1	467
1495CS18BL	7314150326891	1	467
1495CS18BLHK	7314150407620	1	467
1495CS18HK	7314150407613	1	467
1495CS18RED	7314150326907	1	467
1495CS18TS1	7314150325603	1	436
1495FWB097TD	7314150296675	1	467
1495FWB097TS	7314150296651	1	467
1495FWB120TD	7314150296682	1	467
1495FWB120TS	7314150296668	1	467
1495K6CBKWB15TD	7314150369072	1	464
1495K6CBKWB15TS	7314150368990	1	463
1495K6CBKWB15TW	7314150369034	1	464
1495K6CBKWB18TD	7314150369690	1	464
1495K6CBKWB18TS	7314150369591	1	463
1495K6CBKWB18TW	7314150369638	1	464
1495K6CBLWB15TD	7314150369317	1	464
1495K6CBLWB15TS	7314150369119	1	463
1495K6CBLWB15TW	7314150369232	1	464
1495K6CBLWB18TD	7314150369829	1	464
1495K6CBLWB18TS	7314150369744	1	463
1495K6CBLWB18TW	7314150369782	1	464
1495K6CRDWB15TD	7314150368969	1	464
1495K6CRDWB15TS	7314150368600	1	463
1495K6CRDWB15TW	7314150368655	1	464
1495K6CRDWB18TD	7314150369553	1	464
1495K6CRDWB18TS	7314150369478	1	463
1495K6CRDWB18TW	7314150369515	1	464
1495K6CWB15TD	7314150368563	1	464
1495K6CWB15TS	7314150368440	1	463
1495K6CWB15TW	7314150368501	1	464
1495K6CWB18TD	7314150369430	1	464
1495K6CWB18TS	7314150369355	1	463
1495K6CWB18TW	7314150369393	1	464
1495K7CBKWB15TD	7314150369089	1	464
1495K7CBKWB15TS	7314150369003	1	463
1495K7CBKWB15TW	7314150369041	1	464
1495K7CBKWB18TD	7314150369713	1	464
1495K7CBKWB18TS	7314150369607	1	463
1495K7CBKWB18TW	7314150369645	1	464
1495K7CBLWB15TD	7314150369324	1	464
1495K7CBLWB15TS	7314150369164	1	463
1495K7CBLWB15TW	7314150369263	1	464
1495K7CBLWB18TD	7314150369836	1	464
1495K7CBLWB18TS	7314150369751	1	463
1495K7CBLWB18TW	7314150369799	1	464
1495K7CRDWB15TD	7314150368976	1	464
1495K7CRDWB15TS	7314150368624	1	463
1495K7CRDWB15TW	7314150368662	1	464
1495K7CRDWB18TD	7314150369560	1	464
1495K7CRDWB18TS	7314150369485	1	463
1495K7CRDWB18TW	7314150369522	1	464
1495K7CWB15TD	7314150368570	1	464
1495K7CWB15TS	7314150368464	1	463
1495K7CWB15TW	7314150368518	1	464
1495K7CWB18TD	7314150369447	1	464
1495K7CWB18TS	7314150369362	1	463
1495K7CWB18TW	7314150369409	1	464
1495K8CBKWB15TD	7314150369096	1	464
1495K8CBKWB15TS	7314150369010	1	463
1495K8CBKWB15TW	7314150369058	1	464
1495K8CBKWB18TD	7314150369720	1	464
1495K8CBKWB18TS	7314150369614	1	463
1495K8CBKWB18TW	7314150369652	1	464
1495K8CBLWB15TD	7314150369331	1	464
1495K8CBLWB15TS	7314150369188	1	463
1495K8CBLWB15TW	7314150369294	1	464
1495K8CBLWB18TD	7314150369843	1	464
1495K8CBLWB18TS	7314150369768	1	463
1495K8CBLWB18TW	7314150369805	1	464
1495K8CRDWB15TD	7314150368945	1	464
1495K8CRDWB15TS	7314150368631	1	463
1495K8CRDWB15TW	7314150368693	1	464
1495K8CRDWB18TD	7314150369577	1	464
1495K8CRDWB18TS	7314150369492	1	463
1495K8CRDWB18TW	7314150369539	1	464
1495K8CWB15TD	7314150368587	1	464
1495K8CWB15TS	7314150368471	1	463
1495K8CWB15TW	7314150368525	1	464
1495K8CWB18TD	7314150369454	1	464
1495K8CWB18TS	7314150370061	1	463
1495K8CWB18TW	7314150369416	1	464
1495KH6BKWB15TD	7314150418954	1	465
1495KH6BKWB15TS	7314150420063	1	464
1495KH6BKWB15TW	7314150417704	1	465
1495KH6BKWB18TD	7314150420575	1	465
1495KH6BKWB18TS	7314150420728	1	464
1495KH6BKWB18TW	7314150420452	1	465
1495KH6BLWB15TD	7314150418961	1	465
1495KH6BLWB15TS	7314150420216	1	464
1495KH6BLWB15TW	7314150417803	1	465
1495KH6BLWB18TD	7314150420629	1	465
1495KH6BLWB18TS	7314150420759	1	464
1495KH6BLWB18TW	7314150420483	1	465



1495KH6RDWB15TD	7314150418947	1	465
1495KH6RDWB15TS	7314150420032	1	464
1495KH6RDWB15TW	7314150417575	1	465
1495KH6RDWB18TD	7314150420544	1	465
1495KH6RDWB18TS	7314150420698	1	464
1495KH6RDWB18TW	7314150420421	1	465
1495KH6WB15TD	7314150418923	1	465
1495KH6WB15TS	7314150420001	1	464
1495KH6WB15TW	7314150417407	1	465
1495KH6WB18TD	7314150420513	1	465
1495KH6WB18TS	7314150420650	1	464
1495KH6WB18TW	7314150420377	1	465
1495KH7BKWB15TD	7314150419951	1	465
1495KH7BKWB15TS	7314150420193	1	464
1495KH7BKWB15TW	7314150418282	1	465
1495KH7BKWB18TD	7314150420605	1	465
1495KH7BKWB18TS	7314150420735	1	464
1495KH7BKWB18TW	7314150420469	1	465
1495KH7BLWB15TD	7314150419982	1	465
1495KH7BLWB15TS	7314150420223	1	464
1495KH7BLWB15TW	7314150418299	1	465
1495KH7BLWB18TD	7314150420636	1	465
1495KH7BLWB18TS	7314150420766	1	464
1495KH7BLWB18TW	7314150420490	1	465
1495KH7RDWB15TD	7314150419937	1	465
1495KH7RDWB15TS	7314150420049	1	464
1495KH7RDWB15TW	7314150418275	1	465
1495KH7RDWB18TD	7314150420551	1	465
1495KH7RDWB18TS	7314150420704	1	464
1495KH7RDWB18TW	7314150420438	1	465
1495KH7WB15TD	7314150418978	1	465
1495KH7WB15TS	7314150420018	1	464
1495KH7WB15TW	7314150417926	1	465
1495KH7WB18TD	7314150420520	1	465
1495KH7WB18TS	7314150420667	1	464
1495KH7WB18TW	7314150420407	1	465
1495KH8BKWB15TD	7314150419975	1	465
1495KH8BKWB15TS	7314150420209	1	465
1495KH8BKWB15TW	7314150418329	1	465
1495KH8BKWB18TD	7314150420612	1	465
1495KH8BKWB18TS	7314150420742	1	465
1495KH8BKWB18TW	7314150420476	1	465
1495KH8BLWB15TD	7314150419999	1	465
1495KH8BLWB15TS	7314150420360	1	465
1495KH8BLWB15TW	7314150418336	1	465
1495KH8BLWB18TD	7314150420643	1	465
1495KH8BLWB18TS	7314150420773	1	465
1495KH8BLWB18TW	7314150420506	1	465
1495KH8RDWB15TD	7314150419944	1	465
1495KH8RDWB15TS	7314150420056	1	465
1495KH8RDWB15TW	7314150418312	1	465
1495KH8RDWB18TD	7314150420568	1	465
1495KH8RDWB18TS	7314150420711	1	465
1495KH8RDWB18TW	7314150420445	1	465
1495KH8WB15TD	7314150418985	1	465
1495KH8WB15TS	7314150420025	1	464
1495KH8WB15TW	7314150418305	1	465
1495KH8WB18TD	7314150420537	1	465
1495KH8WB18TS	7314150420674	1	464
1495KH8WB18TW	7314150420414	1	465
1495KWB15TD	7314150296637	1	466
1495KWB15TS	7314150338115	1	465
1495KWB15TW	7314150296613	1	466
1495KWB18TD	7314150296644	1	466
1495KWB18TS	7314150338122	1	465
1495KWB18TW	7314150296620	1	466
1495TP-AC1	7314150297030	1	468
1495TP-AC10	7314150297207	1	468
1495TP-AC11	7314150297214	1	468
1495TP-AC12	7314150297221	1	468
1495TP-AC13	7314150297238	1	469
1495TP-AC2	7314150297122	1	469
1495TP-AC3	7314150297139	1	469
1495TP-AC4	7314150297146	1	469
1495TP-AC5	7314150297153	1	469
1495TP-AC6	7314150297160	1	469
1495TP-AC7	7314150297177	1	469
1495TP-AC8	7314150297184	1	469
1495TP-AC9	7314150297191	1	469
1495TP-ACHL20	7314150297047	1	470
1495TP-ACHL40	7314150297054	1	470
1495TP-ACHL65	7314150297061	1	470
1495TP-ACHL90	7314150297078	1	470
1495TP-ACHU20	7314150297085	1	470
1495TP-ACHU40	7314150297092	1	470
1495TP-ACHU65	7314150297108	1	470
1495TP-ACHU90	7314150297115	1	470
1495TP-AUTO-M1	7314150438266	1	447
1495TP-AUTO-M2	7314150438273	1	448
1495TP-AUTO-M3	7314150438280	1	448
1495TP-AUTO-M4	7314150438297	1	448
1495TP-AUTO-M5	7314150438303	1	448
1495TP-AUTO-M6	7314150438310	1	449
1495TP06	7314150296989	1	467
1495TP06GR	7314150326914	1	467
1495TP09	7314150438624	1	467



1495TP09-RAIL



1495TP09-RAIL	7314150465705	1	470
1495TP10W	7314150297023	1	468
1495TP12	7314150296996	1	467
1495TP12GR	7314150326921	1	467
1495TP15	7314150297009	1	467
1495TP15GR	7314150326938	1	467
1495TP18	7314150297016	1	467
1495TP18GR	7314150326945	1	467
1495WB-AC1	7314150296576	1	467
1495WB-AC2	7314150296583	1	467
1495WB15-AC1	7314150296590	1	467
1495WB15-AC1GR	7314150327218	1	467
1495WB15TD	7314150296521	1	466
1495WB15TDGR	7314150327133	1	466
1495WB15TS	7314150296514	1	466
1495WB15TSBK	7314150326983	1	466
1495WB15TSBL	7314150326990	1	466
1495WB15TSBT	7314150407651	1	466
1495WB15TSRED	7314150327003	1	466
1495WB15TW	7314150296538	1	466
1495WB15TWGR	7314150327140	1	466
1495WB18-AC1	7314150296606	1	467
1495WB18-AC1GR	7314150327225	1	467
1495WB18TD	7314150296552	1	466
1495WB18TDGR	7314150327157	1	466
1495WB18TS	7314150296545	1	466
1495WB18TSBK	7314150327010	1	466
1495WB18TSBL	7314150327027	1	466
1495WB18TSBLBT	7314150407644	1	466
1495WB18TSBT	7314150407637	1	466
1495WB18TSRED	7314150327034	1	466
1495WB18TW	7314150296569	1	466
1495WB18TWGR	7314150327164	1	466
1495WBAH15TD	7314150312993	1	467
1495WBAH15TS	7314150313006	1	466
1495WBAH15TSBL	7314150327058	1	466
1495WBAH15TW	7314150313013	1	466
1495WBAH18TD	7314150313037	1	467
1495WBAH18TS	7314150313044	1	466
1495WBAH18TSBK	7314150327089	1	466
1495WBAH18TSBL	7314150327119	1	466
1495WBAH18TSRED	7314150327126	1	466
1495WBAH18TW	7314150313051	1	466
1495WBAH18TWGR	7314150327201	1	466
1496MB2	7314150273478	1	470
1496MB3	7314150273485	1	471
1496MB4	7314150273492	1	471
1496MB5	7314150273508	1	471
1497MB08	7314150349869	1	471
1497MB13	7314150349876	1	471
1497MB18	7314150349913	1	471
1497MBF350	7314150321391	1	471
1497MBF550	7314150321407	1	472
1497MBF750	7314150321414	1	472
14A-32	7314150368228	1	120
14A-9	7314150368211	1	120
14F-1/2	7314150366200	1	118
14F-3/4	7314150366217	1	118
14P-1/2	7314150366064	1	118
14Q-1/2	7314150366026	1	118
14R-1/2	7314150365920	1	117
14R-3/4	7314150365937	1	117
14T-1/2	7314150366125	1	117
14T-3/4	7314150366132	1	117
14W	7314150357031	1	120
1519 D	7314150032747	3	237
1519-9	7314150026074	1	237
1520 D	7311518278922	5	233
1520 G	7311518266516	5	233
1520 G IP	7314150437740	5	233
1535	7314150214808	1	559
1537	7314150214822	1	559
1544	7311518276560	1	559
1546	7314150214792	1	559
1547	7311518276577	20	559
158-N	7311518277239	12	242
158-NB	7311518277246	12	244
1610	7314150404186	1	266
1610-NUT	7314150409594	1	266
1620	7314150404193	1	266
1620-NUT	7314150409754	1	266
166-6-16-2.5-12	7311518021979	12	26
166-6-16-2.5-2	7311518209698	5	26
167-1	7314150419067	1	121
167-1.1/16	7314150419074	1	121
167-1.1/4	7314150419104	1	121
167-1.1/8	7314150419081	1	121
167-1.3/16	7314150419098	1	121
167-1/2	7314150418930	1	121
167-10	7314150418657	1	121
167-11	7314150418664	1	121
167-11/16	7314150419364	1	121
167-12	7314150418671	1	121
167-13	7314150418688	1	121
167-13/16	7314150419036	1	121
167-14	7314150418695	1	121



167-15	7314150418701	1	121
167-15/16	7314150419050	1	121
167-16	7314150418718	1	121
167-17	7314150418725	1	121
167-18	7314150418732	1	121
167-19	7314150418749	1	121
167-20	7314150418763	1	121
167-21	7314150418770	1	121
167-22	7314150418787	1	121
167-23	7314150418794	1	121
167-24	7314150418800	1	121
167-25	7314150418817	1	121
167-26	7314150418824	1	121
167-27	7314150418831	1	121
167-28	7314150418848	1	121
167-3/4	7314150419029	1	121
167-3/8	7314150418909	1	121
167-30	7314150418855	1	121
167-32	7314150418862	1	121
167-36	7314150418886	1	121
167-5/16	7314150418893	1	121
167-5/8	7314150419012	1	121
167-7	7314150418619	1	121
167-7/16	7314150418916	1	121
167-7/8	7314150419043	1	121
167-8	7314150418626	1	121
167-8-21-3.2-12	7311518021986	12	26
167-9	7314150418640	1	121
167-9/16	7314150419005	1	121
168-1	7314150419562	1	122
168-1.1/16	7314150419579	1	122
168-1.3/16	7314150419586	1	122
168-1/2	7314150419487	1	122
168-10	7314150419272	1	122
168-11	7314150419289	1	122
168-11/16	7314150419517	1	122
168-12	7314150419296	1	122
168-13	7314150419302	1	122
168-13/16	7314150419531	1	122
168-14	7314150419319	1	122
168-15	7314150419326	1	122
168-15/16	7314150419555	1	122
168-16	7314150419333	1	122
168-17	7314150419340	1	122
168-18	7314150419357	1	122
168-19	7314150419371	1	122
168-20	7314150419388	1	122
168-21	7314150419395	1	122
168-22	7314150419401	1	122
168-23	7314150419418	1	122
168-24	7314150419425	1	122
168-26	7314150419432	1	122
168-27	7314150419449	1	122
168-3/4	7314150419524	1	122
168-3/8	7314150419463	1	122
168-5/16	7314150419456	1	122
168-5/8	7314150419500	1	122
168-6-3.2-1P	7311518152338	12	26
168-6-3.2-3P	7311518152413	12	27
168-6-3.5-1P	7311518152345	12	26
168-6-3.5-3P	7311518152420	12	27
168-7	7314150419241	1	122
168-7/16	7314150419470	1	122
168-7/8	7314150419548	1	122
168-8	7314150419258	1	122
168-8-4.0-1P	7311518152352	12	26
168-8-4.0-3P	7311518152437	12	27
168-8-4.0-6	7311518217419	6	27
168-8-4.5-1P	7311518152369	12	26
168-8-4.5-3P	7311518152444	12	27
168-8-4.5-6	7311518217426	6	27
168-8-4.8-1P	7311518152376	12	26
168-8-4.8-3P	7311518152451	12	27
168-8-4.8-6	7311518217433	6	27
168-8-5.2-1P	7311518152383	12	26
168-8-5.2-3P	7311518152468	12	27
168-8-5.2-6	7311518217440	6	27
168-8-5.5-1P	7311518152390	12	26
168-8-5.5-3P	7311518152475	12	27
168-8-5.5-6	7311518217457	6	27
168-8-6.3-1P	7311518152406	12	26
168-8-6.3-3P	7311518152482	12	27
168-9	7314150419265	1	122
168-9/16	7314150419494	1	122
168-COMBI-4.0	7311518209667	10	27
168-COMBI-4.0-6922	7311518209612	10	27
168-COMBI-4.5	7314150272860	10	27
168-COMBI-4.8	7311518209674	10	27
168-COMBI-4.8-6920	7311518209643	10	27
168-COMBI-5.5	7311518209681	10	27
168-COMBI-5.5-6924	7311518209650	10	27
169-10	7314150419630	1	122
169-11	7314150419647	1	122
169-12	7314150419654	1	122
169-13	7314150419661	1	122
169-14	7314150419678	1	122



169-15	7314150419715	1	122
169-16	7314150419722	1	122
169-17	7314150419739	1	122
169-18	7314150419746	1	122
169-19	7314150419753	1	122
169-20	7314150419760	1	122
169-21	7314150419777	1	122
169-22	7314150419784	1	122
169-23	7314150419791	1	122
169-24	7314150419807	1	122
169-27	7314150419814	1	122
169-7	7314150419609	1	122
169-8	7314150419616	1	122
169-9	7314150419623	1	122
16F-1/2	7314150418565	1	121
16F-1/4	7314150418541	1	121
16F-3/8	7314150418558	1	121
16R-1/2	7314150418602	1	121
16R-1/4	7314150418589	1	121
16R-3/8	7314150418596	1	121
1931M-10	7314151049256	5	49
1931M-11	7314151049263	5	49
1931M-12	7314151049270	5	49
1931M-13	7314151049287	5	49
1931M-14	7314151049294	5	49
1931M-17	7314151049324	5	49
1931M-4	7314151049171	5	49
1931M-4.5	7314151049188	5	49
1931M-5	7314151049195	5	49
1931M-5.5	7314151049201	5	49
1931M-6	7314151049218	5	49
1931M-7	7314151049225	5	49
1931M-8	7314151049232	5	49
1931M-9	7314151049249	5	49
1931M/10T	7314151049409	1	50
1931Z-1/2	7314151049775	5	49
1931Z-1/4	7314151049713	5	49
1931Z-1/8	7314150371563	5	49
1931Z-11/32	7314151049744	5	49
1931Z-11/32-3/8	7314150371624	5	49
1931Z-13/64	7314151049683	5	49
1931Z-15/64-1/4	7314150371570	5	49
1931Z-3/16	7314151049676	5	49
1931Z-3/8	7314151049751	5	49
1931Z-5/16	7314151049737	5	49
1931Z-5/32	7314151049669	5	49
1931Z-5/8	7314151049799	5	49
1931Z-7/16	7314151049768	5	49
1931Z-7/32	7314151049690	5	49
1931Z-9/16	7314151049782	5	49
1931Z-9/32	7314151049720	5	49
1931Z-9/32-5/16	7314150371600	5	49
1931Z/12T	7314150107674	1	50
1933M/6T	7314151821654	1	50
1936M-10-11	7314151051402	25	57
1936M-10-13	7314151344146	25	57
1936M-12-13	7314151051419	25	57
1936M-13-17	7314151830144	20	57
1936M-14-15	7314151051426	20	57
1936M-14-17	7314151051129	15	57
1936M-16-17	7314151051433	15	57
1936M-17-19	7314151051136	10	57
1936M-18-19	7314151051440	10	57
1936M-19-22	7314151051150	8	57
1936M-20-22	7314151830151	8	57
1936M-21-23	7314151830168	8	57
1936M-22-24	7314151830175	5	57
1936M-24-26	7314151830182	5	57
1936M-24-27	7314151051181	5	57
1936M-25-28	7314151830199	5	57
1936M-30-32	7314151051501	1	57
1936M-30-34	7314151838577	4	57
1936M-36-41	7314151830205	4	57
1936M-46-50	7314151830212	2	57
1936M-6-7	7314151051389	50	57
1936M-8-10	7314151830137	30	57
1936M-8-9	7314151051396	5	57
1936M/12	7314151830250	1	58
1936M/7	7314151830243	1	58
1943M-11-13	7314151052829	1	53
1943M-13-15	7314151804732	1	53
1943M-13-17	7314151804749	1	53
1943M-14-16	7314151052836	1	53
1943M-14-17	7314151052843	1	53
1943M-15-17	7314151052850	1	53
1943M-19-22	7314151052867	1	53
1943Z-11/16-13/16	7314150355174	1	53
1943Z-5/16-3/8	7314150355136	1	53
1943Z-5/8-3/4	7314150355167	1	53
1943Z-7/16-1/2	7314150355143	1	53
1943Z-9/16-5/8	7314150355150	1	53
1945W12	7314150352289	6	316
1945W14	7314150352265	8	316
1945W38	7314150352272	6	316
1949M-10-11	7314151055394	1	54
1949M-10-12	7314151055400	1	54



1949M-12-13	7314151055417	1	54
1949M-12-14	7314151055424	1	54
1949M-14-15	7314151304546	1	54
1949M-14-17	7314151055448	1	54
1949M-17-19	7314151055455	1	54
1949M-19-22	7314151055462	1	54
1949M-22-24	7314151304553	1	54
1949M-24-27	7314151055479	1	54
1949M-30-32	7314151304577	1	54
1949M-8-9	7314151304539	1	54
1949Z-1-1.1/8	7314151055547	1	54
1949Z-1/2-9/16	7314151055509	1	54
1949Z-3/4-7/8	7314151055530	1	54
1949Z-3/8-7/16	7314151055486	1	54
1949Z-5/8-3/4	7314151055523	1	54
1950MZ-3/8	7314150130207	1	55
1952M-10	7314151057213	10	43
1952M-11	7314151057220	10	43
1952M-12	7314151057237	10	43
1952M-13	7314151057244	10	43
1952M-14	7314151057251	10	43
1952M-15	7314151057268	10	43
1952M-16	7314151057275	10	43
1952M-17	7314151057282	10	43
1952M-18	7314151057299	10	43
1952M-19	7314151057305	10	43
1952M-20	7314151057312	10	43
1952M-21	7314151057329	10	43
1952M-22	7314151057336	5	43
1952M-23	7314151057343	5	43
1952M-24	7314151057350	5	43
1952M-25	7314151057367	5	43
1952M-26	7314151057374	5	43
1952M-27	7314151057381	5	43
1952M-28	7314151057398	1	43
1952M-29	7314151325763	1	43
1952M-30	7314151057404	1	43
1952M-32	7314151057411	1	43
1952M-34	7314151838553	1	43
1952M-36	7314151057428	1	43
1952M-41	7314151057435	1	43
1952M-46	7314151840105	1	43
1952M-50	7314151840112	1	43
1952M-55	7314151840129	1	43
1952M-6	7314151057176	10	43
1952M-60	7314151840136	1	43
1952M-65	7314150135226	1	43
1952M-7	7314151057183	10	43
1952M-70	7314150135301	1	43
1952M-75	7314150135325	1	43
1952M-8	7314151057190	10	43
1952M-80	7314150135509	1	43
1952M-9	7314151057206	10	43
1952M/10	7314151057688	1	44
1952M/14T	7314151057695	1	44
1952M/17T	7314151057473	1	44
1952M/26T	7314151057701	1	44
1952M/7T	7314151806637	1	44
1952M/SH12	7314153013330	1	44
1952M/SH6	7314153013286	1	44
1952Z-1	7314151057602	1	43
1952Z-1.1/16	7314151057619	1	43
1952Z-1.1/2	7314151057756	1	43
1952Z-1.1/4	7314151057633	1	43
1952Z-1.1/8	7314151057626	1	43
1952Z-1.3/8	7314151057732	1	43
1952Z-1.5/16	7314151057718	1	43
1952Z-1.5/8	7314151057763	1	43
1952Z-1.7/16	7314151057749	1	43
1952Z-1/2	7314151057527	5	43
1952Z-1/4	7314151057480	5	43
1952Z-11/16	7314151057558	5	43
1952Z-13/16	7314150111046	5	43
1952Z-15/16	7314151057572	5	43
1952Z-3/4	7314151057596	5	43
1952Z-3/8	7314151057565	5	43
1952Z-3/8	7314151057503	5	43
1952Z-5/16	7314151057497	5	43
1952Z-5/8	7314151057541	5	43
1952Z-7/16	7314151057510	5	43
1952Z-7/8	7314151057589	5	43
1952Z-9/16	7314151057534	5	43
1952Z/11T	7314151057725	1	45
1976TORX-T10	7314150123438	5	228
1976TORX-T15	7314150123452	5	228
1976TORX-T20	7314150123469	5	228
1976TORX-T25	7314150123476	5	228
1976TORX-T27	7314150123490	5	228
1976TORX-T30	7314150123506	5	228
1976TORX-T40	7314150123513	5	228
1976TORX-T6	7314150122240	5	228
1976TORX-T7	7314150123384	5	228
1976TORX-T8	7314150123391	5	228
1976TORX-T9	7314150123414	5	228
1976TORX/5T	7314150126927	1	228
1986TORX-T10	7314150123537	5	228



1986TORX-T15



1986TORX-T15	7314150123544	5	228
1986TORX-T20	7314150123551	5	228
1986TORX-T25	7314150123568	5	228
1986TORX-T27	7314150123575	5	228
1986TORX-T30	7314150123582	5	228
1986TORX-T40	7314150123599	5	228
1986TORX-T9	7314150122233	5	228
1986TORX/7T	7314150123735	1	228
1995LM-1.5	7314150122172	10	224
1995LM-10	7314150123254	10	224
1995LM-12	7314150123261	10	224
1995LM-14	7314150123278	10	224
1995LM-2	7314150122189	10	224
1995LM-2.5	7314150123162	10	224
1995LM-3	7314150123179	10	224
1995LM-4	7314150123186	10	224
1995LM-5	7314150123209	10	224
1995LM-6	7314150123216	10	224
1995LM-7	7314150123223	10	224
1995LM-8	7314150123230	10	224
1995LM-9	7314150123247	10	224
1995M-0.9	7314150216291	10	223
1995M-1.5	7314150122158	10	223
1995M-10	7314150122912	10	223
1995M-12	7314150122943	10	223
1995M-14	7314150122967	10	223
1995M-17	7314150122974	10	223
1995M-19	7314150122981	10	223
1995M-2	7314150122745	10	223
1995M-2.5	7314150122752	10	223
1995M-22	7314150122998	10	223
1995M-3	7314150122769	10	223
1995M-4	7314150122776	10	223
1995M-5	7314150122790	10	223
1995M-6	7314150122813	10	223
1995M-7	7314150122837	10	223
1995M-8	7314150122851	10	223
1995M-9	7314150122875	10	223
1995M/10T	7314150123643	1	223
1995M/11T	7314150123650	1	223
1995M/15T	7314150123667	1	223
1995M/6T	7314150123629	1	223
1995M/8T	7314150123636	1	223
1995TORX-T10	7314150123308	5	226
1995TORX-T15	7314150123322	5	226
1995TORX-T20	7314150123339	5	226
1995TORX-T25	7314150123346	5	226
1995TORX-T27	7314150123353	5	226
1995TORX-T30	7314150123360	5	226
1995TORX-T40	7314150123377	5	226
1995TORX-T45	7314150123407	5	226
1995TORX-T50	7314150123421	5	226
1995TORX-T55	7314150216963	5	226
1995TORX-T6	7314150122196	5	226
1995TORX-T60	7314150216970	5	226
1995TORX-T7	7314150123285	5	226
1995TORX-T8	7314150123292	5	226
1995TORX-T9	7314150122219	5	226
1995TORX/11T	7314150123742	1	226
1995TORX/13T	7314150123759	1	227
1995TORX/4T	7314150123674	1	226
1995TORX/7T	7314150123711	1	226
1995Z-1/16	7314150122165	10	223
1995Z-1/2	7314150123117	10	223
1995Z-1/4	7314150123070	10	223
1995Z-1/8	7314150123025	10	223
1995Z-3/16	7314150123056	10	223
1995Z-3/32	7314150123018	10	223
1995Z-3/4	7314150123155	10	223
1995Z-3/8	7314150123094	10	223
1995Z-5/16	7314150123087	10	223
1995Z-5/32	7314150123049	10	223
1995Z-5/64	7314150123001	10	223
1995Z-5/8	7314150123131	10	223
1995Z-7/16	7314150123100	10	223
1995Z-7/32	7314150123063	10	223
1995Z/10T	7314150215980	1	224
1995Z/12T	7314150215997	1	224
1996M-1.5	7314150122202	10	225
1996M-10	7314150122721	10	225
1996M-12	7314150122738	10	225
1996M-2	7314150122653	10	225
1996M-2.5	7314150122660	10	225
1996M-3	7314150122677	10	225
1996M-4	7314150122684	10	225
1996M-5	7314150122691	10	225
1996M-6	7314150122707	10	225
1996M-8	7314150122714	10	225
1996TORX-T10	7314150122783	5	227
1996TORX-T15	7314150122806	5	227
1996TORX-T20	7314150122820	5	227
1996TORX-T25	7314150122844	5	227
1996TORX-T27	7314150122868	5	227
1996TORX-T30	7314150122882	5	227
1996TORX-T40	7314150122899	5	227
1996TORX-T45	7314150122905	5	227



1996TORX-T50	7314150122929	5	227
1996TORX-T9	7314150122226	5	227
1996TORX/5T	7314150123698	1	227
1998M-1.5	7314150185719	10	222
1998M-10	7314150185801	10	222
1998M-12	7314150185818	5	222
1998M-14	7314150185825	1	222
1998M-17	7314150185832	1	222
1998M-19	7314150185849	1	222
1998M-2	7314150185726	10	222
1998M-2.5	7314150185733	10	222
1998M-22	7314150185856	1	222
1998M-3	7314150185740	10	222
1998M-4	7314150185757	10	222
1998M-5	7314150185764	10	222
1998M-6	7314150185863	10	222
1998M-7	7314150185771	10	222
1998M-8	7314150185788	10	222
1998M-9	7314150185795	5	222
1998M/10T	7314150186228	1	222
1998M/11T	7314150186235	1	222
1998M/15T	7314150186242	1	222
1998M/6T	7314150186204	1	222
1998M/8R	7314150186266	1	222
1998M/8T	7314150186211	1	222
1999M/7H	7314151801076	1	222
1999MV-10	7314150121496	3	512
1999MV-12	7314150121502	3	512
1999MV-3	7314150121427	5	512
1999MV-4	7314150121434	5	512
1999MV-5	7314150121441	5	512
1999MV-6	7314150121458	5	512
1999MV-7	7314150121465	5	512
1999MV-8	7314150121472	5	512
1999MV-9	7314150121489	5	512
1RM-10	7314153000576	1	45
1RM-11	7314153000583	1	45
1RM-12	7314153000590	1	45
1RM-13	7314153000606	1	45
1RM-14	7314153000613	1	45
1RM-15	7314153000620	1	45
1RM-16	7314153000637	1	45
1RM-17	7314153000644	1	45
1RM-18	7314153000651	1	45
1RM-19	7314153000668	1	45
1RM-21	7314150214495	1	45
1RM-22	73141530005915	1	45
1RM-24	73141530005922	1	45
1RM-27	7314153014177	1	45
1RM-30	7314153014184	1	45
1RM-32	7314153014191	1	45
1RM-6	7314153014146	1	45
1RM-7	7314153014153	1	45
1RM-8	7314153000552	1	45
1RM-9	7314153000569	1	45
1RM/S5	7314150225514	10	46
1RM/SH12	7314150219780	10	46
1RM/SH6	7314150219773	1	46
1RM/SH8	7314150223015	1	46
1RMA-10-1/4-BIT	7314153014634	1	48
1RMA-10-1/4-SQ	7314153014603	1	48
1RMA-13-10-BIT	7314150223008	1	48
1RMA-13-3/8-SQ	7314153014610	1	48
1RMA-13-5/16-BIT	7314153014641	1	48
1RMA-19-1/2-SQ	7314153014627	1	48
1RMA-19-1/4-SQ	7314150190638	1	48
1RMA/S4	7314153014658	1	48
1RMA/S8	7314153014665	1	48
1RZ-1/2	7314153014245	1	45
1RZ-1/4	7314150153725	1	45
1RZ-11/16	7314153014269	1	45
1RZ-11/32	7314150358915	1	45
1RZ-15/16	7314150358939	1	45
1RZ-3/4	7314153014276	1	45
1RZ-3/8	7314153014214	1	45
1RZ-5/16	7314153014207	1	45
1RZ-5/8	7314153014252	1	45
1RZ-7/16	7314153014221	1	45
1RZ-7/8	7314150358922	1	45
1RZ-9/16	7314153014238	1	45
1RZ/SH8	7314150223022	1	46
1Z-1	7314150375189	10	41
1Z-1/2	7314150375103	10	41
1Z-11/16	7314150375134	10	41
1Z-11/32	7314150375073	10	41
1Z-13/16	7314150375158	10	41
1Z-15/16	7314150375172	5	41
1Z-3/16	7314150375028	20	41
1Z-3/4	7314150375141	10	41
1Z-3/8	7314150375080	10	41
1Z-5/16	7314150375066	10	41
1Z-5/8	7314150375127	10	41
1Z-7/16	7314150375097	10	41
1Z-7/32	7314150375035	20	41
1Z-7/8	7314150375165	10	41
1Z-9/16	7314150375110	10	41



1Z-9/32	7314150375059	20	41
2-21-51	7315962500011	5	648
2-300-14-0-0	7311518044138	10	31
2-300-14-2-0	7311518044145	10	31
2-300-14-4-0	7311518108786	10	31
2-300-14-D-1P	7311518189105	10	34
2-300-16-0-0	7311518020491	10	31
2-300-16-1-0	7311518020507	10	31
2-300-16-2-0	7311518020514	10	31
2-300-16-4-0	7311518020521	10	31
2-300-16-D-1P	7311518189129	10	34
2-300-18-0-0	7311518190545	10	31
2-300-18-2-0	7311518190552	10	31
2-301-14-0-0	7311518190569	10	31
2-301-14-2-0	7311518108748	10	10
2-301-14-D-1P	7311518189136	1	34
2-301-16-0-0	7311518108755	10	31
2-301-16-1-0	7311518020538	10	31
2-301-16-2-0	7311518020545	10	31
2-302-14-0-0	7311518044152	10	32
2-302-14-2-0	7311518044169	10	32
2-302-14-4-0	7311518108793	10	32
2-302-14-D-1P	7311518189150	10	34
2-302-16-0-0	7311518108762	10	32
2-302-16-1-0	7311518020552	10	32
2-302-16-2-0	7311518020569	10	32
2-302-16-4-0	7311518108809	10	32
2-302-16-D-1P	7311518189167	10	34
2-302-18-0-0	7311518190613	10	32
2-302-18-2-0	7311518190620	10	32
2-303-14-2-0	7311518044176	10	32
2-303-14-D-1P	7311518189174	10	34
2-303-16-0-0	7311518108779	10	32
2-303-16-1-0	7311518020576	10	32
2-303-16-2-0	7311518020583	10	32
2-303-16-4-0	7311518108830	10	32
2-303-16-D-1P	7311518189198	1	34
2-303-18-0-0	7311518190644	10	32
2-303-18-2-0	7311518190668	10	32
2-304-14-0-0	7311518044183	10	32
2-304-14-2-0	7311518044190	10	32
2-304-14-4-0	7311518108878	10	32
2-304-14-D-1P	7311518189204	10	34
2-304-16-0-0	7311518020590	10	32
2-304-16-1-0	7311518020606	10	32
2-304-16-2-0	7311518020613	10	32
2-304-16-4-0	7311518020620	10	32
2-304-16-D-1P	7311518189211	10	34
2-304-18-0-0	7311518190712	10	32
2-304-18-2-0	7311518190736	10	32
2-305-16-1-0	7311518020637	10	32
2-305-16-2-0	7311518108908	10	32
2-306-14-D-1P	7311518189228	1	35
2-306-16-1-0	7311518020644	10	32
2-306-16-2-0	7311518108854	10	32
2-307-14-0-0	7311518044206	10	32
2-307-14-2-0	7311518044213	10	32
2-307-14-4-0	7311518108885	10	32
2-307-14-D-1P	7311518189235	10	35
2-307-16-0-0	7311518020651	10	32
2-307-16-1-0	7311518020668	10	32
2-307-16-2-0	7311518020675	10	32
2-307-16-4-0	7311518020682	10	32
2-307-16-D-1P	7311518189242	10	35
2-307-18-0-0	7311518190965	10	32
2-307-18-2-0	7311518190972	10	32
2-308-14-2-0	7311518044220	10	32
2-308-14-D-1P	7311518189259	1	35
2-308-16-0-0	7311518108861	10	32
2-308-16-1-0	7311518020699	10	32
2-308-16-2-0	7311518020705	10	32
2-309-16-2-0	7311518108946	10	32
2-309-16-4-0	7311518191054	10	32
2-313-16-0-0	7311518191177	10	32
2-470-14-0-0	7311518191191	10	33
2-470-14-2-0	7311518109080	10	33
2-470-14-4-0	7311518191207	10	33
2-470-16-1-0	7311518010942	10	33
2-470-16-2-0	7311518109097	10	33
2-471-16-1-0	7311518010959	5	33
2-472-14-0-0	7311518191214	5	34
2-472-14-2-0	7311518109103	5	34
2-472-16-0-0	7311518191238	5	34
2-472-16-1-0	7311518010966	5	34
2-472-16-2-0	7311518108922	5	34
2010	7314151584610	1	478
204030150	8413345400855	12	564
204030160	8413345400862	12	564
204030180	8413345400879	12	564
204050130	8413345097970	6	564
204530140	8413345097918	12	565
204550130	8413345097956	6	565
2045A3000	8413345097932	12	565
2047-0.8-4	7314151060459	5	229
2047-1-5.5	7314151060473	5	229
2047-1.2-8	7314151060480	5	229



2047-1.6-10	7314151060497	1	229
2047-2-12	7314151060503	1	229
2047PR-1-2	7314151060558	5	229
2047PR-3-4	7314151060565	5	229
2047PZ-1-2	7314150216390	5	229
2058-BR	7314151849290	1	86
2058/S26	7314151849276	30	168
2058/S26-2	7314151849283	1	168
208	7311518017545	5	570
209027040	8413345400947	12	565
209227060	8413345400961	12	565
209228100	8413345099233	12	565
209250100	8413345099585	6	565
210	7315965100379	10	570
2100PD-150	7314150205691	5	234
2101D-125	7314150106387	5	232
2101D-125IP	7314150106431	5	232
2101D-140	7314150106394	5	232
2101D-140IP	7314150106325	5	232
2101D-160	7314150106400	5	232
2101D-160IP	7314150106318	5	232
2101D-180	7314150106417	5	232
2101D-180IP	7314150106448	5	232
2101G-125	7314150106462	5	232
2101G-125IP	7314150106516	5	232
2101G-125IPD	7314150335039	5	232
2101G-140	7314150106479	5	232
2101G-140IP	7314150106288	5	232
2101G-140IPD	7314150335053	5	232
2101G-160	7314150106486	5	232
2101G-160IP	7314150106295	5	232
2101G-160IPD	7314150335060	5	232
2101G-180	7314150106493	5	232
2101G-180IP	7314150106523	5	232
2101G-180IPD	7314150335077	5	232
2101GC-125IP	7314150106547	5	232
2101GC-140IP	7314150106554	5	232
2101GC-160IP	7314150106561	5	232
2101GC-180IP	7314150106578	5	232
2101PG-160	7314150113972	5	232
2101S-140	7314150106592	3	509
2101S-160	7314150106608	3	509
2101S-180	7314150106615	3	509
2101S-200	7314150106622	3	509
211035180	8413345000147	5	565
211042210	8413345000154	5	565
212027180	8413345000178	5	565
212033220	8413345129435	8	565
212202500	8413345110266	10	566
212302900	8413345110280	10	566
212502150	8413345110303	10	566
212602150	8413345110327	10	566
212602800	8413345129404	1	566
212704350	8413345122184	6	565
213026140	8413345000185	5	565
2145020D0	8413345097994	1	565
2145020L0	8413345098045	1	566
2145025C0	8413345098083	1	566
2145025D0	8413345098007	1	565
2145025L0	8413345098052	1	566
2145030D0	8413345098014	1	565
2145030L0	8413345098069	1	566
2145035D0	8413345098021	1	565
2145035L0	8413345098076	1	566
2145039C0	8413345098090	1	566
2145PD-150	7314150114009	5	236
215-150	7311518017576	1	572
215000030	8413345131971	12	563
215000040	8413345131988	12	563
215000050	8413345131995	12	563
215000060	8412243557944	12	563
215000070	8413345132008	12	563
215000080	8413345132015	12	563
215000090	8413345132022	12	563
215000100	8413345132039	12	563
215000120	8413345132046	12	563
215500300	7314150220120	12	563
215500400	8413345122627	12	563
215500500	8413345122641	12	563
215500600	8413345122665	12	563
215500700	8413345122689	12	563
215500800	8413345122702	12	563
215500900	8413345137478	12	563
215501000	8413345122726	12	563
216-150-R	7311518017583	1	572
216-300-R	7311518017798	1	572
216000300	8413345403658	12	563
216000400	8413345403665	12	563
216000500	8413345403672	12	563
216000600	8413345403689	12	563
216000700	8413345403696	12	563
216000800	8413345403702	12	563
216000900	8413345403719	12	563
216001000	8413345403726	12	563
216001200	8413345403740	12	563
216100040	8413345132053	12	563





216100060	8413345132091	12	563
216100080	8413345132060	12	563
216100100	8413345132077	12	563
216100120	8413345132084	12	563
216500300	8413345407274	12	563
216500500	8413345407281	12	563
216500750	8413345407298	12	563
216501000	8413345407304	12	563
2171G-140	7314150116232	5	234
2171G-160	7314150116133	5	234
2171G-180	7314150116140	5	234
2171V-160	7314150126798	2	509
2171V-180	7314150126804	2	509
2171V-200	7314150466009	2	509
218	7311518017521	10	571
218-BULK	7311518140946	150	571
219	7311518140953	120	571
219001000	8413345029865	5	563
219001200	8413345029872	5	563
219001400	8413345029889	5	563
219001600	8413345029896	5	563
219002000	8413345029902	5	563
2190PD-150	7314150114016	5	237
219201000	8413345029667	5	563
219201200	8413345029674	5	563
219201400	8413345029681	5	563
219201600	8413345029698	5	563
219202000	8413345029704	5	563
219302500	8413345129466	10	563
219303000	8413345129473	10	563
219303500	8413345129480	10	563
21HDD-140	7314150231256	5	233
21HDD-140IP	7314150231263	5	233
21HDD-160	7314150231270	5	233
21HDD-160IP	7314150231287	5	233
21HDD-180	7314150231294	5	233
21HDD-180IP	7314150231300	5	233
21HDD-200	7314150231317	5	233
21HDD-200IP	7314150231324	5	233
21HDG-140	7314150231331	5	232
21HDG-140A	7314150237654	5	233
21HDG-140IP	7314150231348	5	232
21HDG-160	7314150231355	5	232
21HDG-160A	7314150237661	5	233
21HDG-160IP	7314150231362	5	232
21HDG-180	7314150231379	5	232
21HDG-180A	7314150237678	5	233
21HDG-180IP	7314150231386	5	232
21HDG-200	7314150231409	5	232
21HDG-200A	7314150238439	5	233
21HDG-200IP	7314150231416	5	232
21HDGC-140IP	7314150231423	5	233
21HDGC-160IP	7314150231430	5	233
21HDGC-180IP	7314150231447	5	233
21HDGC-200IP	7314150231454	5	233
221 D	7314150037070	5	248
221201200	8413345029711	5	564
221202000	8413345029728	5	564
221203000	8413345029735	5	564
221301200	8413345029742	5	564
221302000	8413345029759	5	564
221303000	8413345029766	5	564
222 D	7314150037087	5	248
22209004B	8413345401333	1	349
2223 D-150	7314150033591	5	251
2223 G-150	7314150113651	5	251
2223 S-150	7314150032983	3	511
2223V-160	7314150134113	2	511
223 D	7314150037094	5	248
2233 D-160	7314150114023	5	238
2233 D-200	7314150114030	5	238
2233 D-240	7314150114047	5	238
2233D-160IP	7314150114054	5	238
2233D-200IP	7314150114061	5	238
2233D-240IP	7314150114078	5	238
2235-160	7314150179695	1	238
224 D	7314150037100	5	248
225 D	7314150037117	5	248
225-PLUS	7311518029708	5	570
2250V-170	7314150128730	2	509
2250V-230	7314150128747	2	509
227-22	7314150419845	1	121
227-24	7314150419852	1	121
227-27	7314150419869	1	121
227-30	7314150419876	1	121
227-32	7314150419883	1	121
227-34	7314150419890	1	121
227-36	7314150419906	1	121
227-41	7314150419913	1	121
227-46	7314150419920	1	121
228	7311518014995	80	571
228-15-5P	7311518031442	10	572
228-22	7314150420070	1	122
228-24	7314150420087	1	122
228-27	7314150420094	1	122
228-30	7314150420100	1	122



228-32	7314150420117	1	122
228-32-100P	7311518150990	1	572
228-32-10P	7311518010867	10	572
228-32-5P	7311518031459	10	572
228-34	7314150420124	1	122
228-36	7314150420131	1	122
228-41	7314150420148	1	122
228-46	7314150420155	1	122
228-BULK	7311518009069	5	571
228-SD	7311518277048	24	153
228-SET-SD	7314150217946	1	154
229-SD	7311518277055	24	154
22F-3/4	7314150419821	1	121
22R-3/4	7314150419838	1	121
23-15	7311518274665	10	648
23-21	7311518012274	10	648
23-24	7311518003852	10	648
23-30	7311518003869	10	648
23-32	7311518003876	10	648
23-36	7311518003883	10	648
230-SD	7311518280956	25	154
2301C0000	8413345091329	6	564
2303B0000	8413345091404	6	564
2303D0000	8413345091428	6	564
2304C0000	8413345091565	6	564
2308A0000	8413345091602	6	564
2308B0000	8413345091626	6	564
232-SD	7314150214839	1	154
233-300	7311518044015	5	579
233-300-A	7311518044039	5	579
233-400	7311518044022	5	579
2339 D	7314150032792	3	236
2339 DIP	7314150103508	5	236
2339-220	7314150442461	5	237
2339-220IP	7314150101061	5	237
2339-250IP	7314150101078	5	237
2339-280IP	7314150101948	5	237
2339-300IP	7314150123865	6	237
2339D-300	7314150411245	5	236
2339D-300IP	7314150411238	6	236
234-A1	7311518013653	1	579
234-A2	7311518013660	1	579
234-SD	7314150214846	25	154
234-W1	7311518013608	10	579
234-W2	7311518013615	10	579
234-W3	7311518013622	10	579
238	7311518011314	60	571
239	7311518010874	150	571
2420 G-125	7314150102525	5	244
2420G-125IP	7314150447091	5	244
2421 D-140IP	7314150101979	5	245
2421 D-160IP	7314150101986	5	245
2421 D-180IP	7314150101993	5	245
2421 G-140	7314150102532	5	244
2421 G-140IP	7314150102006	5	244
2421 G-160	7314150102549	5	244
2421 G-160 IP	7314150100576	5	244
2421 G-180	7314150102556	5	244
2421 G-180 IP	7314150100583	5	244
2421GC-140IP	7314150447107	5	244
2421GC-160IP	7314150447114	5	244
2421GC-180IP	7314150233229	5	244
2421S-140	7314150447121	3	510
2421S-160	7314150447138	3	510
2421S-180	7314150447145	3	510
2421V-160	7314150126774	2	510
2427 D-160	7314150032846	5	243
2427 D-200	7314150169030	5	243
2427 G-160	7314150100408	5	243
2427 G-160 IP	7314150100743	5	243
2427 G-200	7314150100415	5	243
2427 G-200 IP	7314150100750	5	243
2427 GC-160IP	7314150102051	5	243
2427 GC-200IP	7314150102075	5	243
2427 S-200	7314150033027	3	510
2427S-160	7314150447008	3	510
2427V-200	7314150126903	2	510
2430 D-140	7314150032853	5	241
2430 D-140 IP	7314150100774	5	241
2430 D-160	7314150032860	5	241
2430 D-160 IP	7314150100781	5	241
2430 D-200	7314150032884	5	241
2430 D-200 IP	7314150100804	5	241
2430 G-140	7314150102563	5	241
2430 G-140 IP	7314150102143	5	241
2430 G-160	7314150024070	5	241
2430 G-160 IP	7314150100811	5	241
2430 G-200	7314150100422	5	241
2430 G-200 IP	7314150100835	5	241
2430 GC-140 IP	7314150102150	5	241
2430 GC-160 IP	7314150102167	5	241
2430 GC-200 IP	7314150102174	5	241
2430 S-160	7314150206742	3	510
2430 S-200	7314150033010	3	510
2430S-140	7314150446995	3	510
2430V-160	7314150126880	2	510

Part Number	Quantity	Unit Price	Total Price
2430V-200	2	510	1020
2431G-125	5	241	1205
2431G-125IP	5	241	1205
2431G-140	5	241	1205
2431G-140IP	5	241	1205
2431G-160	5	241	1205
2431G-160IP	5	241	1205
2431G-180	5	241	1205
2431G-180IP	5	241	1205
244-20-U7/8-HP	10	577	5770
244-22-U7/8-HP	10	577	5770
2444	15	597	8955
2446	15	597	8955
2446-BL	15	598	8970
2446-EL	12	598	7176
2446-EL-HELP	12	598	7176
2446-ELL	12	598	7176
2446-ELR	12	598	7176
2446-LAP	15	597	8955
2446-LINO	12	598	7176
2446-OV	15	598	8970
2446-SAFE	15	598	8970
2448	12	586	7032
2449	12	586	7032
244P-20-U7-HP	4	579	2316
244P-22-U7-HP	10	579	5790
2460	1	250	250
2461 C19	1	249	249
2461 C40	1	249	249
2461 C8	1	249	249
2463 D19	1	249	249
2463 D40	1	249	249
2463 D8	1	249	249
2464 A10	1	250	250
2464 A19	1	250	250
2464 A3	1	250	250
2464 A40	1	250	250
2465D-200	1	250	250
2466 B10	1	250	250
2466 B19	1	250	250
2466 B3	1	250	250
2466 B40	1	250	250
247-24	1	119	119
247-27	1	119	119
247-30	1	119	119
247-32	1	119	119
247-34	1	119	119
247-36	1	119	119
247-41	1	119	119
247-46	1	119	119
247-50	1	119	119
247-55	1	119	119
247-60	1	119	119
2470 G-160	5	242	1210
2470 G-200	5	242	1210
2471 G-160	5	245	1225
2477 G-200	5	244	1220
248-24	1	119	119
248-27	1	119	119
248-30	1	119	119
248-32	1	119	119
248-34	1	119	119
248-36	1	119	119
248-41	1	119	119
248-46	1	119	119
248-50	1	119	119
248-55	1	119	119
248-60	1	119	119
2484-20	1	372	372
2484-30	1	372	372
2484-45	1	372	372
2484-60	1	372	372
2484/S4	10	372	3720
2484T-20	1	372	372
2484T-30	1	372	372
2484T-45	1	372	372
2484T-60	1	372	372
2484T/S4	1	372	372
2485	1	348	348
2487	12	549	6588
2488	12	564	6768
2489	12	564	6768
24A-14	1	120	120
24A-27	1	120	120
24F-1	1	118	118
24F-3/4	1	118	118
24R-1	1	117	117
24R-3/4	1	117	117
24T-1	1	117	117
24T-3/4	1	117	117
24W	1	120	120
250400000	1	566	566
250400010	1	566	566
250400020	1	566	566
250400030	1	567	567
250501800	50	567	28350

Part Number	Quantity	Unit Price	Total Price
250502450	1	567	567
2509	50	373	18650
2520	1	238	238
2520 S	1	509	509
2520-SH	1	238	238
2521 G-140	5	246	1230
2521 G-160 IP	5	246	1230
2521D-140IP	5	246	1230
2521D-160IP	5	246	1230
2521G-140IP	5	246	1230
2521G-160	3	246	738
2521S-140	5	510	2550
2521S-160	3	510	1530
2521V-160	2	511	1022
2530	1	373	373
2530-40	5	549	2745
2535F0	1	373	373
2535F1	1	373	373
2535F2	1	373	373
2535F3	1	373	373
2535L	12	373	4476
255-17/34	2	575	1150
255-34	2	575	1150
2555	1	309	309
256-26	4	575	2300
2600-16-XT11-HP	4	576	2304
2600-19-XT-HP	4	577	2308
2600-22-XT-HP	4	577	2308
2620-80	1	238	238
2628 D-160	5	240	1200
2628 D-180	5	240	1200
2628 D-200	5	240	1200
2628 G-160	5	239	1195
2628 G-160IP	5	239	1195
2628 G-180	5	239	1195
2628 G-180IP	5	239	1195
2628 G-200	5	239	1195
2628 GC-160IP	5	239	1195
2628 GC-180IP	5	239	1195
2628 GC-200IP	5	239	1195
2628 S-160	3	509	1527
2628 S-180	3	509	1527
2628 S-200	3	509	1527
2628G-200IP	5	239	1195
2629G-160	5	240	1200
2629G-160IP	5	240	1200
2629G-180	5	240	1200
2629G-180IP	5	240	1200
2629G-200	5	240	1200
2629G-200IP	5	240	1200
2630DC-160IP	5	240	1200
2630DC-180IP	5	240	1200
2630DC-200IP	5	240	1200
2630GC-160IP	5	240	1200
2630GC-180IP	5	240	1200
2630GC-200IP	5	240	1200
2630SC-180	3	510	1530
2632	1	372	372
2633/S4	12	548	6576
2633HD/S6	1	316	316
2633HD1	1	316	316
2633HD2	1	316	316
2633HD3	1	316	316
2633HD4	1	316	316
2633HD5	1	316	316
2633HD6	1	316	316
2633L/S4	12	548	6576
2635	1	623	623
2640D-160	10	240	2400
2640D-180	5	240	1200
2640D-200	5	240	1200
2646	1	235	235
2646 A	1	235	235
2646 AK	1	235	235
2646 K	1	235	235
2646 M	1	235	235
2646 MF	1	245	245
2646 MS	1	246	246
2646 R	1	235	235
2646 RA	1	235	235
2646 RK	1	235	235
2648	1	235	235
2648 A	1	235	235
2649	1	235	235
2650	1	248	248
2650 B	1	248	248
2656	1	237	237
2656 R	1	244	244
2656 S	1	242	242
2666	1	235	235
2666 FK	1	235	235
2674 NB	1	234	234
2674 NVDE	1	509	509
2676 B	1	235	235
2678 B	1	235	235
2678 G-160	5	241	1205



2678 G-180



2678 G-180	7314150116164	5	241
2678 G-200	7314150116171	5	241
2678V-160	7314150126835	2	510
2678V-180	7314150126842	2	510
2678V-200	7314150126859	2	510
268	7311518017538	5	571
2681	7311518276706	12	262
2681-1	7314150116980	1	263
2688D-250	7314150123520	3	240
2690	7314150411108	10	263
26S-1216	7314151830236	8	59
26S-16	7314150345588	5	59
26S-610	7314151830229	10	59
2700-22-XT7-HP	7311518191672	4	579
2700-24-XT7-HP	7311518191665	4	579
2704A	7314151066963	1	593
2705R	7314151821470	1	593
2720	7314150179701	1	238
2720-SH	7314150179718	1	238
2744	7314151809096	6	593
277-30	7314150367184	1	119
277-32	7314150367191	1	119
277-34	7314150367207	1	119
277-36	7314150367214	1	119
277-41	7314150367221	1	119
277-46	7314150367238	1	119
277-50	7314150367245	1	119
277-55	7314150367252	1	119
277-60	7314150367269	1	119
278-30	7314150367924	1	119
278-32	7314150367931	1	119
278-34	7314150367948	1	119
278-36	7314150367955	1	119
278-41	7314150367962	1	119
278-46	7314150367979	1	119
278-50	7314150367986	1	119
278-55	7314150367993	1	119
278-60	7314150368006	1	119
2784-2.5	7314150215607	1	214
2784-3.5	7314150215614	1	214
2784-4.5	7314150215621	1	214
2787 F	7314151474270	1	236
2787 G	7314150058020	1	236
27A-24	7314150368259	1	120
27F-1	7314150366248	1	118
27M-10-11	7314150180523	10	58
27M-12-13	7314150180547	10	58
27M-13-17	7314150180790	10	58
27M-14-15	7314150180554	10	58
27M-16-17	7314150180561	10	58
27M-16-18	7314150180806	10	58
27M-18-19	7314150180578	10	58
27M-20-22	7314150180585	10	58
27M-21-23	7314150180592	5	58
27M-21-24	7314150180813	5	58
27M-24-26	7314150180608	5	58
27M-24-27	7314150180820	5	58
27M-25-28	7314150180622	5	58
27M-27-29	7314150180639	5	58
27M-30-32	7314150180646	5	58
27M-6-7	7314150180509	10	58
27M-8-9	7314150180516	10	58
27M/10	7314150180677	1	58
27M/12	7314150180684	1	59
27M/12T	7314150180783	1	58
27M/6	7314150180653	1	58
27M/8	7314150180660	1	58
27M/8T	7314150180776	1	58
27R-1	7314150365968	1	117
27T-1	7314150366163	1	117
28-29/S4	7314150179688	1	251
2800 N	7314151318338	1	239
2800-140	7314150121632	3	249
2800-150	7314150034567	3	249
2800-180	7314150034581	3	249
2800-225	7314150034604	3	249
2800-300	7314150122622	1	249
2801 N	7314151318352	1	239
2804	7314151692698	1	238
2805-280	7314151826123	1	238
2820EF1	7314150122042	12	599
2820EF2	7314150122059	8	599
2820EF3	7314150122066	1	600
2820EF4	7314150122073	1	600
2820EK	7314150122035	6	599
2820EK-01	7314150270743	12	599
2820V13	7314150121823	1	512
2820VBC	7314150121915	1	509
2820VDE	7314151605476	10	513
2820VFP	7314150121922	1	513
2820VG05	7314150121953	1	514
2820VG10	7314150121960	1	514
2820VGCOT	7314150121977	1	514
2820VHELP	7314150121908	1	513
2820VMM	7314150121946	1	514
2820VVP	7314150121885	2	513



2820VPC	7314150121892	2	513
2820VTEE	7314150121939	1	513
2855	7314151825805	1	264
2855 D	7314151822569	1	264
2856-10	7314150437214	1	264
2856-8	7314150437207	1	264
2890-125	7314150122639	3	249
2890-140	7314150034550	3	249
2890-180	7314150034574	3	249
2890-210	7314150034598	3	249
2890-300	7314150122646	1	249
28M-10	7314151834678	5	56
28M-11	7314151834685	5	56
28M-12	7314151834692	5	56
28M-13	7314151834708	5	56
28M-14	7314151834715	5	56
28M-15	7314151834722	5	56
28M-16	7314151834739	5	56
28M-17	7314151834746	5	56
28M-18	7314151834753	3	56
28M-19	7314151834760	3	56
28M-20	7314150122561	3	56
28M-21	7314151834777	3	56
28M-22	7314151834784	3	56
28M-23	7314150122578	3	56
28M-24	7314151834791	3	56
28M-25	7314150122585	3	56
28M-26	7314150122592	3	56
28M-27	7314151834807	3	56
28M-28	7314150122608	1	56
28M-29	7314150122615	1	56
28M-30	7314151834814	1	56
28M-32	7314151834821	1	56
28M-6	7314151834630	5	56
28M-7	7314151834647	5	56
28M-8	7314151834654	5	56
28M-9	7314151834661	5	56
28M/11	7314151838126	1	57
28M/12	7314151838133	1	57
28M/15	7314151838140	1	57
28M/8	7314151838119	1	57
28MV-10	7314150121298	2	512
28MV-11	7314150121304	2	512
28MV-12	7314150121311	2	512
28MV-13	7314150121328	2	512
28MV-14	7314150121335	2	512
28MV-15	7314150121342	2	512
28MV-16	7314150121359	2	512
28MV-17	7314150121366	2	512
28MV-18	7314150121373	2	512
28MV-19	7314150121380	2	512
28MV-20	7314150121397	2	512
28MV-21	7314150121403	2	512
28MV-22	7314150121410	2	512
28MV-8	7314150121274	2	512
28MV-9	7314150121281	2	512
29-B	7311518277703	1	328
2900-140	7314150121045	3	249
2900-150	7314150034499	3	249
2900-180	7314150034512	3	249
2900-215	7314150034536	3	249
2900-300	7314150121076	1	249
2928-1	7314150056583	1	250
2928-160	7314150056514	1	250
2928-2	7314150056590	1	250
2928-200	7314150056521	1	250
2928-250	7314150056538	1	250
2928-3	7314150056606	1	250
2928-4	7314150056613	1	250
2949-190IP	7314150123926	1	262
2949-200IP	7314150123940	1	262
2949-240IP	7314150123957	1	262
2949-250IP	7314150123971	1	262
2949-L075	7314150440559	1	262
2949-L120	7314150440566	1	262
2949-L200	7314150440573	1	262
2950-250	7314150124039	1	261
2951-140	7314150124084	1	259
2951-180	7314150102204	1	259
2951-250	7314150102211	1	259
2951-300	7314150102228	1	259
2951-S05	7314150447299	1	262
2951-S07	7314150447305	1	262
2951-S10	7314150447312	1	262
2951-S12	7314150447329	1	262
2952-165	7314150103836	1	259
2952-235	7314150103843	1	259
2953-140	7314150124046	1	259
2953-200	7314150124053	1	259
2953-250	7314150124060	1	259
2953-300	7314150124077	1	259
2955-250	7314150102235	1	260
2956-290	7314150413690	1	261
2957-250	7314150102259	1	259
2958-140	7314150124104	1	259
2958-200	7314150124114	1	259



2958-250	7314150102242	1	259
296	7311518034146	1	581
2960-280	7314150412808	1	260
2962-8-150	7314150412815	1	261
2962-8-230	7314150413706	1	261
2962-8-300	7314150413713	1	261
2963-280	7314150102280	1	260
2963-450	7314150124138	1	260
2963-630	7314150124145	1	260
2964-160	7314150124183	1	261
2964-280	7314150102297	1	261
2964-450	7314150124190	1	261
2964-600	7314150124206	1	261
2965-200	7314150124152	1	261
2965-280	7314150102266	1	261
2966-280	7314150102273	1	261
2967-180	7314150102396	1	260
2968-190	7314150124091	1	259
2968-235	7314150103850	1	259
2970G-200	7314150134946	5	241
2971G-250	7314150117154	5	248
2979 D-180	7314150034246	5	246
2990-125	7314150121250	3	249
2990-140	7314150034482	3	249
2990-180	7314150034505	3	249
2990-200	7314150034529	3	249
2990-300	7314150121267	1	249
2997-250	7314150124237	1	262
2997-300	7314150124244	5	262
2998-250	7314150124213	1	260
2998-SHN	7314150447275	1	260
2999-250	7314150124169	1	260
2999-SHN	7314150447282	1	260
29M-10	7314150122318	5	56
29M-11	7314150122325	5	56
29M-12	7314150122332	5	56
29M-13	7314150122349	5	56
29M-14	7314150122356	5	56
29M-15	7314150122363	5	56
29M-16	7314150122370	5	56
29M-17	7314150122387	5	56
29M-18	7314150122394	3	56
29M-19	7314150122400	3	56
29M-20	7314150122417	3	56
29M-21	7314150122424	3	56
29M-22	7314150122431	3	56
29M-23	7314150122448	3	56
29M-24	7314150122455	3	56
29M-25	7314150122462	3	56
29M-26	7314150122479	3	56
29M-27	7314150122486	3	56
29M-28	7314150122493	1	56
29M-29	7314150122509	1	56
29M-30	7314150122516	1	56
29M-32	7314150122523	1	56
29M-6	7314150122271	5	56
29M-7	7314150122288	5	56
29M-8	7314150122295	5	56
29M-9	7314150122301	5	56
29M/10	7314150122547	1	57
29M/14	7314150122554	1	57
29M/8	7314150122530	1	57
2M-10-11	7314151001223	5	52
2M-10-13	7314151001513	5	52
2M-12-13	7314151001230	5	52
2M-13-17	7314151343972	5	52
2M-14-15	7314151001247	5	52
2M-16-17	7314151001254	5	52
2M-16-18	7314151001575	5	52
2M-17-19	7314151000844	5	52
2M-18-19	7314151001261	5	52
2M-19-22	7314151000868	5	52
2M-20-22	7314151001278	5	52
2M-21-23	7314151001285	5	52
2M-22-24	7314151001612	5	52
2M-24-26	7314151001292	5	52
2M-24-27	7314151000899	5	52
2M-25-28	7314151001308	5	52
2M-27-29	7314150205332	5	52
2M-27-30	7314151001636	5	52
2M-27-32	7314151001322	5	52
2M-30-32	7314151000929	5	52
2M-32-36	7314151001667	1	52
2M-36-41	7314151001681	1	52
2M-41-46	7314151001704	1	52
2M-46-50	7314151001711	1	52
2M-6-7	7314151001209	5	52
2M-8-10	7314151001506	5	52
2M-8-9	7314151001216	5	52
2M/10T	7314150212996	1	52
2M/12T	7314151001414	1	52
2M/8T	7314151001391	1	52
2M/S8	7314151827335	1	52
2MV-10	7314150121113	5	512
2MV-11	7314150121120	5	512
2MV-12	7314150121137	5	512



2MV-13	7314150121144	5	512
2MV-14	7314150121151	5	512
2MV-15	7314150121168	5	512
2MV-16	7314150121175	5	512
2MV-17	7314150121182	3	512
2MV-18	7314150121199	3	512
2MV-19	7314150121205	3	512
2MV-21	7314150121212	3	512
2MV-22	7314150121229	3	512
2MV-23	7314150121236	3	512
2MV-24	7314150121243	3	512
2MV-6	7314150121069	5	512
2MV-7	7314150121083	5	512
2MV-8	7314150121090	5	512
2MV-9	7314150121106	5	512
2Z-1-1.1/8	7314151001827	1	52
2Z-1.1/16-1.1/4	7314151001834	1	52
2Z-1/2-9/16	7314151001445	1	52
2Z-1/4-5/16	7314151001421	1	52
2Z-13/16-7/8	7314151001797	1	52
2Z-15/16-1	7314151001810	1	52
2Z-3/4-7/8	7314151001773	1	52
2Z-3/8-7/16	7314151001438	1	52
2Z-5/16-3/8	7314151001728	1	52
2Z-5/8-11/16	7314151001452	1	52
2Z-9/16-5/8	7314151001735	1	52
2Z/7T	7314150217373	1	53
3-24-51	7315962500028	5	648
3-330-12-1-0	7311518020712	5	31
3-330-12-2-0	7311518020729	5	31
3-330-14-1-0	7311518020736	5	31
3-330-14-2-0	7311518020743	5	31
3-331-14-1-0	7311518020750	5	31
300-14-F15/16-HP	7311518005955	4	575
301	7311518001384	50	581
301-16	7314150456048	12	269
301-22	7311518293673	12	269
302	7311518013349	30	580
302-15-95	7314150486632	100	269
302-35	7311518293680	6	269
302-511W-12P	7311518207786	1	581
302-51W-12P	7311518013356	1	581
302-53W-12P	7311518013363	1	581
302-55W-12P	7311518013370	1	581
302-57W-12P	7311518013387	1	581
302-59W-12P	7311518207779	1	581
302-6X4P	7311518017590	1	581
302-71M-12P	7311518013394	1	581
302-73M-12P	7311518013400	1	581
302-75M-12P	7311518013417	1	581
302-76-95	7314150188345	1	269
302-76N	7314150456307	6	269
302-77M-12P	7311518207793	1	581
302-81S-12P	7311518013677	1	581
302-83S-12P	7311518013684	1	581
302-85S-12P	7311518207809	1	581
302-95-SET	7314150456321	1	269
303-5P	7311518031435	10	581
304	7311518265533	10	570
304S/1VDE	7314151783815	1	515
304S-V1	7314150128785	1	515
304S-V2	7314150128792	1	515
3046-OP	7311518276980	12	549
3046-REF	7311518276966	1	309
3049-2	7314151848118	1	478
306	7311518265540	10	570
306-10	7314150120246	1	268
306-12	7314150120253	1	268
306-15	7311518297107	12	268
306-15-95	7311518297329	1	269
306-22	7311518297114	12	268
306601500	8413345098700	5	602
306602000	8413345098717	5	602
306603000	8413345217033	5	602
306604000	8413345217095	5	602
306703000	8413345217194	5	602
306704000	8413345098755	5	602
306705000	8413345098762	5	602
306706000	8413345098779	5	602
306708000	8413345098786	5	602
306710000	8413345098793	5	602
306712000	8413345123334	2	602
306715000	8413345123341	2	602
306803000	8413345098809	5	602
306804000	8413345098816	5	602
306805000	8413345098823	2	602
306806000	8413345098830	2	602
306808000	8413345098847	2	602
306810000	8413345098854	2	602
306812000	8413345098861	2	602
306815000	8413345098878	1	602
306820000	8413345098885	1	602
306903000	8413345123402	2	602
306904000	8413345123419	2	602
306905000	8413345123426	2	602
306906000	8413345123433	2	602





306908000	8413345123457	2	602
306910000	8413345123471	2	602
307401B	7314150254958	1	268
307411B	7314150254965	1	268
307421B	7314150254972	1	268
307431B	7314150254989	1	268
307441	7314150235933	1	268
307451	7314150235940	1	268
308504000	8413345035156	1	558
308505000	8413345035194	1	558
308506000	8413345035163	1	558
308508000	8413345035170	1	558
308510000	8413345035187	1	558
3090-20-XT11-HP	7311518181369	4	577
31	7314150004942	5	40
31 IP	7314150004959	50	40
31-T	7314150483709	5	40
31-T IP	7314150483723	50	40
3100TB	7314150125364	1	472
3100TB-DISP	7314150400300	1	473
310M-24	7314151829612	1	56
310M-27	7314151829629	1	56
310M-30	7314151829636	1	56
310M-32	7314151829643	1	56
310M-36	7314151829650	1	56
310M-38	7314151829667	1	56
310M-41	7314151829674	1	56
310M-46	7314151829681	1	56
310M-50	7314151829698	1	56
310M-55	7314151829704	1	56
310M-60	7314151829711	1	56
310M-65	7314151829728	1	56
310M-70	7314151829735	1	56
310M-75	7314151829742	1	56
310M-80	7314151829759	1	56
310M-85	7314151829766	1	56
310M-90	7314151829773	1	56
310M-95	7314151829780	1	56
311-32	7314150120215	6	270
311-42	7311518295523	6	270
3115	7314150055326	1	366
3149-OR	7311518292249	1	471
3149-ORFF1	7314150292479	1	440
3149-ORTS1	7314150292066	1	440
3150-12-XT9-HP	7311518181406	4	574
315M-27	7314150133291	1	55
315M-30	7314150133307	1	55
315M-32	7314150133314	1	55
315M-36	7314150133321	1	55
315M-41	7314150133345	1	55
315M-46	7314150133352	1	55
315M-50	7314150133369	1	55
315M-55	7314150133376	1	55
315M-60	7314150133383	1	55
315M-65	7314150133390	1	55
315M-70	7314150133406	1	55
315M-75	7314150133413	1	55
315M-80	7314150133420	1	55
315Z-1.1/16	7314150133437	1	56
315Z-1.1/2	7314150133505	1	56
315Z-1.1/4	7314150133468	1	56
315Z-1.1/8	7314150133444	1	56
315Z-1.11/16	7314150133529	1	56
315Z-1.13/16	7314150133543	1	56
315Z-1.15/16	7314150133567	1	56
315Z-1.3/16	7314150133451	1	56
315Z-1.3/4	7314150133536	1	56
315Z-1.3/8	7314150133482	1	56
315Z-1.5/16	7314150133475	1	56
315Z-1.5/8	7314150133512	1	56
315Z-1.7/16	7314150133499	1	56
315Z-1.7/8	7314150133550	1	56
315Z-2	7314150133574	1	56
315Z-2.1/16	7314150133581	1	56
315Z-2.1/2	7314150133642	1	56
315Z-2.1/4	7314150133611	1	56
315Z-2.1/8	7314150133598	1	56
315Z-2.15/16	7314150133697	1	56
315Z-2.3/16	7314150133604	1	56
315Z-2.3/4	7314150133673	1	56
315Z-2.3/8	7314150133635	1	56
315Z-2.5/16	7314150133628	1	56
315Z-2.5/8	7314150133666	1	56
315Z-2.7/8	7314150133680	1	56
315Z-2.9/16	7314150133659	1	56
315Z-3	7314150133703	1	56
315Z-3.1/8	7314150133840	1	56
316-1	7311518296216	12	271
316-2	7311518296223	12	271
316-2-95	7311518296278	1	271
317	7311518240936	10	570
317-40	7311518296230	12	271
318-38	7311518296247	1	271
318-54	7311518296254	1	271
3180-14-XT11-HP	7311518181390	4	576
319	7311518240943	5	570



320	7311518265557	10	570
321	7311518001841	5	570
321-18-SB	7311518129125	10	572
321-24-SB	7311518129132	10	572
321-7-SB	7311518129149	10	572
322500300	8413345012829	1	547
322500500	8413345012836	1	547
322500800	8413345012843	1	547
322510300	8413345015899	1	547
322510400	8413345137386	1	547
322510500	8413345015905	1	547
322510600	8413345137393	1	547
322510700	8413345137409	1	547
322510800	8413345015912	1	547
3240-14-XT11-HP	7311518243005	4	576
325	7311518214852	5	570
325001000	8413345000505	1	547
3250010SH	8413345137492	1	547
326000200	8413345000529	1	547
326000300	8413345012881	1	547
326010200	8413345016100	1	547
326020200	8413345016117	1	547
326030200	8413345016124	1	547
327020500	7314150330584	1	547
327020500-SH1	7314150361021	1	548
327020500-SH2	7314150361038	1	548
327020500-SH3	7314150361045	1	548
327020500-SH4	7314150361052	1	548
3280M	7314151071318	1	50
329000330	8413345000741	1	548
329000500	8413345000758	1	548
329500300	7314150181001	1	547
329500350	7314150181049	1	548
329500400	7314150181018	1	547
329500450	7314150181056	1	548
329600100	7314150181063	1	548
329600200	7314150181070	1	548
329600500	7314150181025	1	547
329600800	7314150181032	1	547
331-15-23	7311518274658	5	647
331-21-51-KP	7311518003814	5	647
332-21-51	7311518229337	5	647
333	7311518005832	5	648
333-5	7311518005849	10	648
339-6T	7311518128371	4	644
33H	7314150266791	5	40
340-6T	7311518002008	4	644
341	7314150113729	1	266
3416 A	7314150216260	1	252
3416 A SH	7314150410941	1	252
3416 B	7314150411160	10	251
3416 B SH	7314150411191	10	251
3417 A	7314150216277	12	253
3418 A	7314150216284	1	252
3419 B	7314151812416	1	254
3419 B SH	7314150504381	1	254
342	7314150113736	1	266
343	7314150113743	1	266
344	7314150113750	1	266
349	7311518018924	4	648
3517 A	7314150410910	1	253
3518 A	7314150216376	1	252
3518 A SH	7314150216383	1	252
3518 B	7314150410927	1	252
3520 A	7314150410934	1	252
3520 A SH	7314150410958	1	252
3520 B	7314150411177	10	252
3520 B SH	7314150411207	10	252
3524	7314151073336	1	549
3524L-K	7314151339807	1	549
3525HB	7314151073350	5	549
36	7314150223381	5	607
361-10	7311518295202	1	267
361-12	7311518295219	1	267
361-14	7311518295226	1	267
361-18	7311518295233	1	267
361-24	7311518295240	1	267
361-36	7311518295257	4	267
361-8	7311518295196	1	267
3619 A	7314150411184	10	253
3619 A SH	7314150411214	10	253
3625AR-35	7314150214723	34	610
3625AR-50	7314150214730	18	610
3625AR-60	7314150214747	12	610
3625ARL-35	7314150214754	6	610
3625ARL-50	7314150214761	6	610
3625ARL-60	7314150214778	6	610
3625ARLH-35	7314150218677	80	611
3625ARLH-50	7314150218684	50	611
3625ARLH-60	7314150218691	16	611
3625N-22	7314151073602	6	611
3625N-32	7314151073640	6	611
3625N-40	7314151073688	6	611
3625N-50	7314151073701	6	611
3625NL-22	7314151073831	20	612
3625NL-32	7314151073855	20	612



3625NL-40	7314151073879	20	612
3625NL-50	7314151073886	20	612
3625PU-105	7314150170098	4	611
3625PU-30	7311518276119	12	611
3625PU-50	7311518276126	6	611
3625PU-60	7311518276133	6	611
3625RM-55	7314150120758	50	612
3625RM-65	7314150120765	40	612
3625RM-75	7314153019820	30	612
3625RM-90	7314150120390	20	612
3625S-28	7314150183906	50	612
3625S-35	7314150183913	30	612
3625S-44	7314150183920	18	612
3625W-22	7314150120406	120	612
3625W-28	7314150120413	72	612
3625W-35	7314150120420	40	612
3625W-44	7314150120437	1	612
3625W-55	7314150120444	12	612
3625WL-22	7314150120451	10	612
3625WL-28	7314150120468	10	612
3625WL-35	7314150120475	10	612
3625WL-44	7314150120482	10	612
3625WL-55	7314150120499	6	612
3625WLH-22	7314150219025	50	612
3625WLH-28	7314150218981	50	612
3625WLH-35	7314150218998	80	612
3625WLH-44	7314150219001	50	612
3625WLH-55	7314150219018	16	612
3625Y-22	7314151074074	6	611
3625Y-32	7314151074098	6	611
3625Y-40	7314151074111	6	611
3625Y-50	7314151074128	6	611
3625YL-22	7314151074159	20	611
3625YL-32	7314151074173	20	611
3625YL-40	7314151074197	20	611
3625YL-50	7314151074203	20	611
363-32	7311518295578	1	268
3640-150-C	7314150180691	25	618
3640-175-C	7314150180707	6	618
3640-200-C	7314150180714	25	618
3640-250-C	7314150180721	20	618
3640-300-C	7314150180738	25	618
3643-100	7314151074654	50	620
3643-120	7314151074678	50	620
3643-150	7314151074685	50	620
3644-120	7314151074708	50	620
3644-125	7314151074722	50	620
3644-130	7314151074746	50	620
3644-150	7314151074760	50	620
3644-165	7314151074777	50	620
3644-180	7314151074791	50	620
3644-200	7314151074807	50	620
3646-115	7314151074937	250	621
3646-125	7314151074944	250	621
3646-150	7314151074951	125	621
3646-165	7314151074968	125	621
3646-180	7314151074975	50	621
3646-200	7314151074982	50	621
3646/6	7314151074999	25	621
3649-125	7314150472413	50	618
3654BMS/7	7314150220816	1	624
3654R	7314151075132	1	621
3656-125	7314150472352	50	618
3656-150	7314150472376	50	618
3656-175	7314150472390	1	618
3656/10	7314151075279	1	622
3658A-2	7314151075293	125	621
3658A-3	7314151075309	125	621
3658A-4	7314151075316	125	621
3658A-5	7314151075323	125	621
3658A-6	7314151075330	125	621
3658A-8	7314151075347	50	621
3658A/6	7314151075354	30	622
3659-0.9	7314151075507	5	621
3659-1.4	7314151075514	5	621
3659-1.8	7314151597351	5	621
3659-2.4	7314151075538	5	621
3659-2.8	7314151597436	5	621
3659-3.4	7314151075552	5	621
3659-3.9	7314151075569	5	621
3659-6.0	7314151075576	5	621
3659/8	7314151075583	1	622
3659/8T	7314151472573	1	622
3680	7314151075835	1	372
3681-11	7314150132980	1	373
3681-16	7314150132997	1	373
3681-20	7314150133000	1	373
3683	7314151075866	1	373
3684-16	7314150133017	1	372
3684-18	7314150133024	1	372
3684-24	7314150133031	1	372
3684-30	7314150133048	1	372
369-BLADE	7311518016531	20	575
370-4	7311518296193	1	268
3717 A	7314150489916	1	253
3718 A	7314150489930	12	253



3719 A	7314150489954	12	253
372-1.1/2	7314150133239	1	267
372-12	7314150133284	1	267
372-2.1/2	7314150133246	1	267
372-4	7314150133253	1	267
372-6	7314150133260	1	267
372-8	7314150133277	1	267
3733-2	7314151834371	50	621
3733-3	7314151834388	50	621
3733-4	7314151834395	50	621
3733-5	7314151834401	50	621
3733-6	7314151834418	50	621
3733S/5	7314150220809	25	622
3734-2	7314151834296	50	621
3734-3	7314151834319	50	621
3734-4	7314151834326	50	621
3734-5	7314151834333	50	621
3734-6	7314151834340	50	621
3734-8	7314151834357	50	621
3734BMS/7	7314150220755	1	624
3734N-10-150	7314150218110	10	621
3734N-2-150	7314150218042	10	621
3734N-3-150	7314150218059	10	621
3734N-4-150	7314150218066	10	621
3734N-5-150	7314150218073	10	621
3734N-6-150	7314150218080	10	621
3734N-7-150	7314150218097	10	621
3734N-8-150	7314150218103	10	621
3734N-9-150	7314150218127	10	621
3734NS/9	7314150218134	10	622
3734S/6	7314151834470	5	622
3735-4-120	7314151834265	50	620
3735-5-120	7314151834272	50	620
3735-5-150	7314151834289	50	620
3735N-2-100	7314150217953	10	620
3735N-4-120	7314150217960	10	620
3735N-5-120	7314150217977	10	620
3735N-6-150	7314150217984	10	620
3735N-8-150	7314150217991	10	620
3735NS/4	7314150218004	25	620
3736M-200	7314150220878	30	619
3736M-250	7314151834142	25	619
3736M-300	7314151834159	10	619
3736M-400	7314151834166	10	619
3736MH-250	7314151834173	10	619
3736MH-300	7314151834180	10	619
3736MH-400	7314151834197	5	619
3736S/6	7314151834463	5	619
3739-250	7314151834203	25	619
3739-300	7314151834210	10	619
3739-400	7314151834227	10	619
3739H-250	7314151834234	15	619
3739H-300	7314151834241	10	619
3739H-400	7314151834258	10	619
3740-100	7314151834005	50	618
3740-125	7314151834012	50	618
3740-150	7314151834029	50	618
3740-175	7314151834036	25	618
3740-200	7314151834043	25	618
3740-250	7314151834050	10	618
3740-300	7314151834067	10	618
3745-150	7314151834081	50	618
3745-175	7314151834098	25	618
3745-200	7314151834104	20	618
3745-250	7314151834111	10	618
3749-125	7314150457915	50	618
375-8	7311518296209	50	268
3750	7314151834128	25	618
3750H	7314151834135	25	619
3756-125	7314150457892	50	618
3756-150	7314150457908	50	618
38-12	7314151831264	5	331
38-16	7314151831271	5	331
38-20	7314151831288	2	331
38-24	7314151831295	1	331
38-8	7314151831257	5	331
380-10	7314150133178	1	267
380-14	7314150133185	1	267
380-18	7314150133192	1	267
380-24	7314150133208	1	267
380-36	7314150133215	1	267
380-48	7314150133222	1	267
3802-300-25-1.25-10	7311518111229	10	20
3802-300-25-1.25-14	7311518111236	10	20
3802-300-25-1.25-6	7311518143299	10	20
3802-300-32-1.60-10	7311518111274	10	20
3802-300-32-1.60-6	7311518111298	10	20
3802-350-25-1.25-10	7311518111335	10	20
3802-350-25-1.25-14	7311518111342	10	20
3802-350-25-1.25-6	7311518111359	10	20
3802-350-32-1.60-10	7311518111397	10	20
3802-350-32-1.60-14	7311518111403	10	20
3802-350-32-1.60-4	7311518111410	10	20
3802-350-32-1.60-6	7311518111427	10	20
3802-350-32-1.60-8	7311518140908	10	20
3802-400-25-1.25-10	7311518111496	10	20



3802-400-25-1.25-14



3802-400-25-1.25-14	7311518111502	10	20
3802-400-25-1.25-6	7311518111519	10	20
3802-400-32-1.60-10	7311518111557	10	20
3802-400-32-1.60-14	7311518111564	10	20
3802-400-32-1.60-4	7311518111571	10	20
3802-400-32-1.60-6	7311518111588	10	20
3802-400-32-1.60-8	7311518111595	10	20
3802-400-38-2.00-10	7311518111649	10	20
3802-400-38-2.00-4	7311518111656	10	20
3802-400-38-2.00-6	7311518111663	10	20
3802-425-32-1.60-10	7311518111694	10	20
3802-425-32-1.60-6	7311518111700	10	20
3802-450-32-1.60-10	7311518111731	10	20
3802-450-32-1.60-14	7311518111748	10	20
3802-450-32-1.60-4	7311518111755	10	20
3802-450-32-1.60-6	7311518111762	10	20
3802-450-38-2.00-10	7311518111816	10	20
3802-450-38-2.00-10-KA	7311518111823	10	20
3802-450-38-2.00-4	7311518111830	10	20
3802-450-38-2.00-4-KA	7311518111847	10	20
3802-450-38-2.00-6	7311518111854	10	20
3802-450-38-2.00-6-KA	7311518111861	10	20
3802-450-38-2.00-8	7311518111878	10	20
3802-450-38-2.00-8-KA	7311518111885	10	20
3802-475-38-2.00-8	7311518111317	10	20
3802-500-38-2.00-10	7311518111953	10	20
3802-500-38-2.00-4	7311518111960	10	20
3802-500-38-2.00-6	7311518111977	10	20
3802-500-38-2.00-8	73115181113070	10	20
3802-500-45-2.25-10	7311518111984	10	20
3802-500-50-2.50-4	7311518112028	10	20
3802-500-50-2.50-4-KA	7311518112035	10	20
3802-500-50-2.50-6	7311518112042	10	20
3802-500-50-2.50-6-KA	7311518112059	10	20
3802-525-38-2.00-10	7311518112073	10	20
3802-525-38-2.00-6	7311518112097	10	20
3802-525-38-2.00-8	7311518112103	10	20
3802-550-38-2.00-6	7311518112158	10	20
3802-550-50-2.50-10	7311518112196	10	20
3802-550-50-2.50-4	7311518112202	10	20
3802-550-50-2.50-4-KA	7311518112219	10	20
3802-550-50-2.50-6	7311518112226	10	20
3802-550-50-2.50-8	7311518112240	5	20
3802-550-50-2.50-8-KA	7311518113315	10	20
3802-575-50-2.50-3-KA	7311518112301	10	20
3802-575-50-2.50-4	7311518112318	10	20
3802-575-50-2.50-4-KA	7311518112325	10	20
3802-575-50-2.50-6	7311518112332	10	20
3802-575-50-2.50-6-KA	7311518112349	10	20
3802-600-50-2.50-4	7311518112417	10	20
3802-600-50-2.50-6	7311518112431	10	20
3802-600-50-2.50-8	7311518112455	10	20
3802-650-50-2.50-4	7311518112509	5	20
3802-650-50-2.50-4-KA	7311518112523	5	20
3802-650-50-2.50-6	7311518112530	5	20
3802-650-50-2.50-6-KA	7311518112554	5	20
3802-700-50-2.50-2-KA	7311518112578	5	20
3802-700-50-2.50-3	7311518112585	5	20
3802-700-50-2.50-4	7311518112608	5	20
3802-700-50-2.50-4-KA	7311518112615	5	20
3802-700-50-2.50-6	7311518112622	5	20
3802-700-50-2.50-6-KA	7311518112639	5	20
3802-750-50-2.50-4	7311518112660	5	20
3802-750-50-2.50-6	7311518112677	5	20
3806-600-32	7311518018092	10	57
3809-300-25-1.25-10	7311518113711	10	19
3809-300-25-1.25-14	7311518113728	10	19
3809-300-32-1.60-10	7311518113735	10	19
3809-300-32-1.60-6	7311518113742	10	19
3809-350-25-1.25-10	7311518113759	10	19
3809-350-25-1.25-14	7311518113766	10	19
3809-350-25-1.25-6	7311518113773	10	19
3809-350-32-1.60-10	7311518113780	10	19
3809-350-32-1.60-14	7311518113797	10	19
3809-350-32-1.60-4	7311518113803	10	19
3809-350-32-1.60-6	7311518113810	10	19
3809-350-32-1.60-8	7311518113827	10	19
3809-350-32-2.00-10	7311518113834	10	19
3809-350-32-2.00-4	7311518113841	10	19
3809-350-32-2.00-6	7311518113858	10	19
3809-350-38-2.00-10	7311518113865	10	19
3809-350-38-2.00-6	7311518113889	10	19
3809-400-25-1.25-10	7311518178666	10	19
3809-400-32-1.60-10	7311518113896	10	19
3809-400-32-1.60-14	7311518113902	10	19
3809-400-32-1.60-4	7311518113919	10	19
3809-400-32-1.60-6	7311518113933	10	19
3809-400-32-1.60-8	7311518113940	10	19
3809-400-32-2.00-10	7311518113957	10	19
3809-400-32-2.00-4	7311518113964	10	19
3809-400-32-2.00-6	7311518113971	10	19
3809-400-32-2.00-6-KA	7311518158248	10	20
3809-400-32-2.00-8	7311518114152	10	19
3809-400-38-2.00-10	7311518113988	10	19
3809-400-38-2.00-4	7311518113995	10	19
3809-400-38-2.00-6	7311518114008	10	19



3809-425-32-1.60-10	7311518114015	10	19
3809-425-32-1.60-6	7311518197759	10	19
3809-450-32-1.60-10	7311518114022	10	19
3809-450-32-1.60-14	7311518114039	10	19
3809-450-32-1.60-4	7311518114046	10	19
3809-450-32-1.60-6	7311518114053	10	19
3809-450-32-2.00-10	7311518114060	10	19
3809-450-32-2.00-4	7311518114077	10	19
3809-450-32-2.00-6	7311518114084	10	19
3809-450-38-2.00-10	7311518114091	10	19
3809-450-38-2.00-10-KA	7311518114107	10	20
3809-450-38-2.00-4	7311518114114	10	19
3809-450-38-2.00-4-KA	7311518114121	10	20
3809-450-38-2.00-6	7311518114138	10	19
3809-450-38-2.00-6-KA	7311518114145	10	20
3809-450-38-2.00-8	7311518114176	10	19
3809-450-45-2.25-4	7311518114206	10	19
3809-450-45-2.25-6	7311518114213	10	19
3809-475-45-2.25-6	7311518114237	10	19
3809-500-38-2.00-10	7311518114244	10	19
3809-500-38-2.00-4	7311518114251	10	19
3809-500-38-2.00-6	7311518114268	10	19
3809-500-45-2.25-4	7311518114275	10	19
3809-500-45-2.25-6	7311518114299	10	19
3809-500-45-2.25-6-KA	7311518114305	10	20
3809-500-50-2.50-4	7311518114312	10	19
3809-500-50-2.50-4-KA	7311518114329	10	20
3809-500-50-2.50-6	7311518114336	10	19
3809-500-50-2.50-6-KA	7311518114343	10	20
3809-500-50-2.50-8	7311518114350	10	19
3809-525-38-2.00-10	7311518114367	10	19
3809-525-38-2.00-6	7311518114374	10	19
3809-525-45-2.25-4	7311518114381	10	19
3809-525-45-2.25-6	7311518114398	10	19
3809-550-45-2.25-4	7311518114411	10	19
3809-550-45-2.25-6	7311518114428	10	19
3809-550-50-2.50-4	7311518114435	10	19
3809-550-50-2.50-4-KA	7311518114442	10	20
3809-550-50-2.50-6	7311518114459	10	19
3809-550-50-2.50-6-KA	7311518114466	10	20
3809-575-45-2.25-4	7311518114473	10	19
3809-575-50-2.50-10-KA	7311518114497	10	20
3809-575-50-2.50-3	7311518114602	10	19
3809-575-50-2.50-3-KA	7311518114503	10	19
3809-575-50-2.50-4	7311518114510	10	19
3809-575-50-2.50-4-KA	7311518114527	10	20
3809-575-50-2.50-6	7311518114534	10	19
3809-575-50-2.50-6-KA	7311518114541	10	20
3809-600-38-2.00-6	7311518227579	10	19
3809-600-45-2.25-4	7311518172275	10	19
3809-600-45-2.25-6	7311518114558	10	19
3809-600-50-2.50-3	7311518114565	10	19
3809-600-50-2.50-4	7311518114572	10	19
3809-600-50-2.50-4-KA	7311518114589	10	20
3809-600-50-2.50-6	7311518114596	10	19
3809-600-50-2.50-6-KA	7311518114626	10	20
3809-650-50-2.50-3-KA	7311518114640	5	20
3809-650-50-2.50-4	7311518114657	5	19
3809-650-50-2.50-4-KA	7311518114664	5	20
3809-650-50-2.50-6	7311518114671	5	19
3809-650-50-2.50-6-KA	7311518114688	5	20
3809-700-50-2.50-3-KA	7311518114695	5	20
3809-700-50-2.50-4	7311518114701	5	19
3809-700-50-2.50-4-KA	7311518114718	5	20
3809-700-50-2.50-6	7311518114725	5	19
3809-700-50-2.50-6-KA	7311518114732	5	20
3809-750-50-2.50-4	7311518114749	5	19
3809-750-50-2.50-6	7311518234009	5	19
3815-200-2.0-32-1-03BW	7311518160258	1	17
3815-200-2.0-32-1-04BW	7311518160241	1	17
3815-225-2.0-32-1-03BW	7311518160319	1	17
3815-225-2.0-32-1-04BW	7311518158347	1	17
3815-225-2.0-32-1-05BW	7311518160302	1	17
3815-225-2.0-32-1-06C	7311518160296	1	17
3815-250-2.0-32-1-03BW	7311518160586	1	17
3815-250-2.0-32-1-04BW	7311518160579	1	17
3815-250-2.0-32-1-05BW	7311518158354	1	17
3815-250-2.0-32-1-06C	7311518160562	1	17
3815-250-2.0-40-2-03BW	7311518160340	1	17
3815-250-2.0-40-2-04BW	7311518174446	1	17
3815-250-2.0-40-2-05BW	7311518160333	1	17
3815-275-2.5-32-1-04BW	7311518160593	1	17
3815-275-2.5-32-1-05BW	7311518158361	1	17
3815-275-2.5-32-1-06C	7311518174590	1	17
3815-275-2.5-32-1-08C	7311518174583	1	17
3815-275-2.5-40-2-03BW	7311518176433	1	17
3815-275-2.5-40-2-04BW	7311518160623	1	17
3815-275-2.5-40-2-05BW	7311518158378	1	17
3815-275-2.5-40-2-06C	7311518160616	1	17
3815-275-2.5-40-2-08C	7311518160609	1	17
3815-300-2.5-32-1-04BW	7311518160630	1	17
3815-300-2.5-32-1-05BW	7311518158385	1	17
3815-300-2.5-32-1-05C	7311518174699	1	17
3815-300-2.5-32-1-06C	7311518174705	1	17
3815-300-2.5-32-1-08C	7311518174712	1	17
3815-315-2.5-32-1-04BW	7311518160210	1	17

Item	Code	QTY	Unit
3815-315-2.5-32-1-05BW	7311518160203	1	17
3815-315-2.5-32-1-06C	7311518160197	1	17
3815-315-2.5-32-1-08C	7311518160401	1	17
3815-315-2.5-40-2-04BW	7311518160456	1	17
3815-315-2.5-40-2-05BW	7311518160449	1	17
3815-315-3.0-40-2-06C	7311518174842	1	17
3815-350-2.5-32-1-04BW	7311518197605	1	17
3815-350-2.5-32-1-06C	7311518197612	1	17
3815-370-3.0-50-4-08C	7311518174989	1	17
3815-370-3.0-50-4-10C	7311518174996	1	17
3815-400-3.5-50-4-10C	7311518160494	1	17
3816-300	7311518015749	50	572
3818-300-PROG-100	7311518288105	100	571
3818-300-PROG-5P	7314150265589	10	571
383-6T	7311518128876	4	644
3830-102-C	7311518225612	1	124
3830-102-VIP	7311518042035	4	124
3830-105-C	7311518225629	1	124
3830-105-VIP	7311518042042	4	124
3830-108-C	7311518228521	1	124
3830-108-VIP	7311518042059	4	124
3830-111-C	7311518228538	1	124
3830-111-VIP	7311518042066	4	124
3830-114-C	7311518225636	1	124
3830-114-VIP	7311518042073	4	124
3830-121-C	7311518225643	1	124
3830-121-VIP	7311518042080	1	124
3830-127-C	7311518225650	1	124
3830-127-VIP	7311518042097	1	124
3830-133-C	7311518228545	1	124
3830-133-VIP	7311518042103	1	124
3830-14-C	7311518228347	1	124
3830-14-VIP	7311518041618	6	124
3830-140-C	7311518228552	1	124
3830-140-VIP	7311518042110	1	124
3830-146-C	7311518228569	1	124
3830-146-VIP	7311518042127	1	124
3830-152-C	7311518225667	1	124
3830-152-VIP	7311518042134	1	124
3830-16-C	7311518225353	1	124
3830-16-VIP	7311518041625	6	124
3830-168	7311518040659	1	124
3830-17-C	7311518228354	1	124
3830-17-VIP	7311518041632	6	124
3830-177-HIGH	7311518101329	1	124
3830-19-4P	7314150428557	1	124
3830-19-C	7311518225360	1	124
3830-19-VIP	7311518041649	6	124
3830-20-4P	7314150428601	1	124
3830-20-C	7311518225377	1	124
3830-20-VIP	7311518041656	6	124
3830-21-C	7311518228361	1	124
3830-21-VIP	7311518041663	6	124
3830-210	7311518040666	1	124
3830-22-4P	7314150428649	1	124
3830-22-C	7311518225384	1	124
3830-22-VIP	7311518041670	6	124
3830-24-C	7311518228378	1	124
3830-24-VIP	7311518041687	6	124
3830-25-4P	7314150428663	1	124
3830-25-C	7311518225391	1	124
3830-25-VIP	7311518041694	6	124
3830-27-4P	7314150428670	1	124
3830-27-C	7311518225407	1	124
3830-27-VIP	7311518041700	6	124
3830-29-4P	7314150428922	1	124
3830-29-C	7311518225414	1	124
3830-29-VIP	7311518041717	6	124
3830-30-4P	7314150433483	1	124
3830-30-C	7311518225421	1	124
3830-30-VIP	7311518041724	6	124
3830-32-4P	7314150428687	1	124
3830-32-C	7311518225438	1	124
3830-32-VIP	7311518041731	6	124
3830-33-C	7311518228385	1	124
3830-33-VIP	7311518041748	6	124
3830-35-4P	7314150428700	1	124
3830-35-C	7311518225445	1	124
3830-35-VIP	7311518041755	6	124
3830-37-C	7311518228392	1	124
3830-37-VIP	7311518041762	6	124
3830-38-C	7311518225452	1	124
3830-38-VIP	7311518041779	6	124
3830-40-C	7311518228408	1	124
3830-40-VIP	7311518041786	6	124
3830-41-C	7311518225469	1	124
3830-41-VIP	7311518041793	6	124
3830-43-C	7311518228415	1	124
3830-43-VIP	7311518041809	6	124
3830-44-C	7311518225476	1	124
3830-44-VIP	7311518041816	6	124
3830-46-C	7311518228422	1	124
3830-46-VIP	7311518041823	6	124
3830-48-C	7311518225483	1	124
3830-48-VIP	7311518041830	6	124
3830-50-C	7311518260873	1	124

Item	Code	QTY	Unit
3830-50-VIP	7311518260866	6	124
3830-51-C	7311518225490	1	124
3830-51-VIP	7311518041847	6	124
3830-52-C	7311518228439	1	124
3830-52-VIP	7311518041854	4	124
3830-54-C	7311518225506	1	124
3830-54-VIP	7311518041861	4	124
3830-55-C	7311518270919	1	124
3830-55-VIP	7311518270902	4	124
3830-56-C	7311518228446	1	124
3830-56-VIP	7311518152703	4	124
3830-57-C	7311518225513	1	124
3830-57-VIP	7311518041878	4	124
3830-59-C	7311518228453	1	124
3830-59-VIP	7311518041885	4	124
3830-60-C	7311518225520	1	124
3830-60-VIP	7311518041892	4	124
3830-62-VIP	7311518234645	4	124
3830-64-C	7311518225537	1	124
3830-64-VIP	7311518041908	4	124
3830-65-C	7311518228460	1	124
3830-65-VIP	7311518041915	4	124
3830-67-C	7311518225544	1	124
3830-67-VIP	7311518041922	4	124
3830-68-C	7311518228477	1	124
3830-68-VIP	7311518196530	4	124
3830-70-C	7311518225551	1	124
3830-70-VIP	7311518041939	4	124
3830-73-C	7311518228484	1	124
3830-73-VIP	7311518041946	4	124
3830-76-C	7311518225568	1	124
3830-76-VIP	7311518041953	4	124
3830-79-C	7311518228491	1	124
3830-79-VIP	7311518041960	4	124
3830-83-C	7311518225575	1	124
3830-83-VIP	7311518041977	4	124
3830-86-C	7311518228507	1	124
3830-86-VIP	7311518041984	4	124
3830-89-C	7311518225582	1	124
3830-89-VIP	7311518041991	4	124
3830-92-C	7311518225599	1	124
3830-92-VIP	7311518042004	4	124
3830-95-C	7311518225605	1	124
3830-95-VIP	7311518042011	4	124
3830-98-C	7311518228514	1	124
3830-98-VIP	7311518042028	4	124
3832-102	7311518558567	4	131
3832-102-C	7314150474394	1	132
3832-105	7311518558581	4	131
3832-108	7311518558604	4	131
3832-111	7311518558611	4	131
3832-114	7311518558628	4	131
3832-114-C	7314150474424	1	132
3832-121	7311518558642	1	131
3832-127	7311518558666	1	131
3832-127-C	7314150474431	1	132
3832-133	7311518558673	1	131
3832-14	7311518557744	6	131
3832-140	7311518558680	1	131
3832-146	7311518558697	1	131
3832-152	7311518558703	1	131
3832-16	7311518557768	6	131
3832-16-C	7314150474448	1	132
3832-17	7311518557782	6	131
3832-19	7311518557805	6	131
3832-19-C	7314150474455	1	132
3832-20	7311518557812	6	131
3832-20-C	7314150474462	1	132
3832-21	7311518557829	6	131
3832-22	7311518557843	6	131
3832-22-C	7314150474479	1	132
3832-24	7311518557867	6	131
3832-24-C	7314150479054	1	132
3832-25	7311518557881	6	131
3832-25-C	7314150474486	1	132
3832-27	7311518557904	6	131
3832-29	7311518557928	6	131
3832-29-C	7314150474493	1	132
3832-30	7311518557942	6	131
3832-30-C	7314150479061	1	132
3832-32	7311518557966	6	131
3832-32-C	7314150474509	1	132
3832-33	7311518557980	6	131
3832-35	7311518558000	6	131
3832-35-C	7314150474516	1	132
3832-37	7311518558024	6	131
3832-38	7311518558048	6	131
3832-38-C	7314150474523	1	132
3832-40	7311518558062	6	131
3832-41	7311518558086	6	131
3832-41-C	7314150474530	1	132
3832-43	7311518558109	6	131
3832-44	7311518558123	6	131
3832-44-C	7314150474547	1	132
3832-46	7311518558147	6	131
3832-46-C	7314150479078	1	132





3832-48	7311518558161	6	131
3832-48-C	7314150474554	1	132
3832-51	7311518558185	6	131
3832-51-C	7314150474561	1	132
3832-52	7311518558208	4	131
3832-54	7311518558222	4	131
3832-54-C	7314150474578	1	132
3832-56	7311518558239	4	131
3832-57	7311518558246	4	131
3832-57-C	7314150474585	1	132
3832-59	7311518558260	4	131
3832-60	7311518558284	4	131
3832-60-C	7314150474615	1	132
3832-64	7311518558307	4	131
3832-64-C	7314150474622	1	132
3832-65	7311518558321	4	131
3832-67	7311518558345	4	131
3832-68	7311518558352	4	131
3832-70	7311518558369	4	131
3832-73	7311518558383	4	131
3832-73-C	7314150474639	1	132
3832-76	7311518558406	4	131
3832-76-C	7314150474646	1	132
3832-79	7311518558420	4	131
3832-83	7311518558444	4	131
3832-83-C	7314150474653	1	132
3832-86	7311518558468	4	131
3832-86-C	7314150474660	1	132
3832-89	7311518558482	4	131
3832-92	7311518558505	4	131
3832-92-C	7314150474677	1	132
3832-95	7311518558529	4	131
3832-98	7311518558543	4	131
3832-SET-164-ES	7314150487349	1	132
3832-SET-84-ES	7314150498932	1	132
3833-102-C	7314150263899	1	129
3833-105-C	7314150263905	1	129
3833-108-C	7314150263912	1	129
3833-109-C	7314150263929	1	129
3833-111-C	7314150263936	1	129
3833-114-C	7314150263943	1	129
3833-121-C	7314150263950	1	129
3833-127-C	7314150263967	1	129
3833-133-C	7314150401581	1	129
3833-140-C	7314150263974	1	129
3833-152-C	7314150263981	1	129
3833-159-C	7314150263998	1	129
3833-168	7314150413546	1	129
3833-177	7314150413539	1	129
3833-19-C	7314150263561	1	129
3833-20-C	7314150263578	1	129
3833-210	7314150413522	1	129
3833-22-C	7314150263585	1	129
3833-225	7314150413515	1	129
3833-25-C	7314150263592	1	129
3833-27-C	7314150263608	1	129
3833-29-C	7314150263615	1	129
3833-30-C	7314150263622	1	129
3833-32-C	7314150263639	1	129
3833-35-C	7314150263646	1	129
3833-38-C	7314150263653	1	129
3833-40-C	7314150263660	1	129
3833-41-C	7314150263677	1	129
3833-44-C	7314150263684	1	129
3833-48-C	7314150263691	1	129
3833-51-C	7314150263707	1	129
3833-54-C	7314150263714	1	129
3833-56-C	7314150314676	1	129
3833-57-C	7314150263721	1	129
3833-60-C	7314150263738	1	129
3833-62-C	7314150314683	1	129
3833-64-C	7314150263745	1	129
3833-65-C	7314150263752	1	129
3833-67-C	7314150263769	1	129
3833-68-C	7314150263776	1	129
3833-70-C	7314150263783	1	129
3833-71-C	7314150314690	1	129
3833-73-C	7314150263790	1	129
3833-74-C	7314150314706	1	129
3833-76-C	7314150263806	1	129
3833-77-C	7314150263813	1	129
3833-78-C	7314150314713	1	129
3833-79-C	7314150263820	1	129
3833-83-C	7314150263837	1	129
3833-86-C	7314150263844	1	129
3833-89-C	7314150263851	1	129
3833-92-C	7314150263868	1	129
3833-95-C	7314150263875	1	129
3833-98-C	7314150263882	1	129
3833-PROMO-42	7314150464951	1	129
3833-SET-101	7314150315383	1	129
3833-SET-201	7314150315406	1	129
3833-SET-202	7314150315420	1	129
3833-SET-203	7314150315444	1	130
3833-SET-204	7314150315468	1	130
3833-SET-205	7314150330874	1	130



3833-SET-207	7314150330898	1	130
3833-SET-208	7314150330904	1	130
3833-SET-301	7314150315376	1	130
3833-SET-302	7314150315390	1	131
3833-SET-303	7314150315413	1	131
3833-SET-304	7314150315437	1	131
3834-ADP	7311518454425	1	134
3834-ARBR-11152	7311518015596	1	133
3834-ARBR-11152-C	7311518225698	1	133
3834-ARBR-11152QC	7311518167967	1	133
3834-ARBR-11152QC-C	7311518225711	1	133
3834-ARBR-1130	7311518015572	4	133
3834-ARBR-1130-C	7311518228583	1	133
3834-ARBR-16152	7311518015602	1	133
3834-ARBR-16152QC	7311518453152	1	133
3834-ARBR-630	7311518015558	1	133
3834-ARBR-630-C	7311518228576	1	133
3834-ARBR-730	7311518167974	1	133
3834-ARBR-730-C	7311518225674	1	133
3834-ARBR-9100	7311518015589	1	133
3834-ARBR-9100-C	7311518228590	1	133
3834-ARBR-9100EL	7314150265077	1	132
3834-ARBR-9100ESM	7314150390458	1	132
3834-ARBR-9100QC	7311518249830	1	133
3834-ARBR-9100QC-C	7311518225704	1	133
3834-ARBR-930	7311518015565	1	133
3834-ARBR-930-C	7311518225681	1	133
3834-ARBR-930EL	7314150265053	1	132
3834-ARBR-930ESM	7314150390465	1	132
3834-ARBR-SD152QC	7311518203825	1	133
3834-ARBR-SD30	7311518203818	1	133
3834-CP-20/25	7314150312092	1	124
3834-DRL	7311518234638	1	133
3834-DRL-CT	7311518953201	1	133
3834-DRL-EL	7314150265114	1	132
3834-DRL-ES	7314150265091	1	133
3834-DRL-HSS-ES	7314150339396	1	133
3834-DRL-L	7314150265138	1	133
3834-ES	7311518454418	1	133
3834-EXT-1	7311518040673	1	133
3834-EXT-2	7311518168070	1	133
3834-M6X29-SET	7314150383450	1	134
3834-M8X10-SET	7314150383429	1	134
3834-M8X5-SET	7314150383443	1	134
3834-M8X6-SET	7314150383436	1	134
3834-PROMO-122	7314150432059	1	125
3834-PROMO-122-76	7314150459193	1	125
3834-PROMO-82	7314150432042	1	125
3834-SET-103	7314150134908	1	128
3834-SET-152	7314150255658	1	128
3834-SET-42	7311518241988	1	125
3834-SET-53	7314150127153	1	125
3834-SET-61	7311518266431	1	126
3834-SET-62	7311518228040	1	126
3834-SET-62-16/50	7311518258887	1	126
3834-SET-65-16/51	7311518159900	1	126
3834-SET-65-22/64	7311518159917	1	126
3834-SET-72	7311518044992	1	126
3834-SET-72-35/83	7314150444229	1	125
3834-SET-73	7311518254339	1	127
3834-SET-73-22/68	7314150134809	1	127
3834-SET-77	7314150235919	1	127
3834-SET-84-ES	7314150470587	1	127
3834-SET-86	7311518224295	1	127
3834-SET-87	7311518181772	1	127
3834-SET-92	7311518044985	1	128
3834-SET-93	7314150414741	1	128
3834-SET-94	7311518166458	1	128
3834-SET-95	7311518159894	1	128
3834-UPSIZE	7314150344567	1	133
3835-SET-64	7314150423309	1	132
3835-SET-711	7314150465835	1	132
384-5T	7311518159795	4	644
384-6T	7311518002039	4	644
3845-18-10P	7311518101602	1	135
3845-24-10P	7311518101619	1	135
3845-32-10P	7311518101626	1	135
385-6T	7311518002053	4	644
3851-10-0.6-10/14	7311518182717	1	12
3851-10-0.6-H-4	7311518282776	1	12
3851-10-0.6-H-6	7311518282806	1	12
3851-10-0.6-HA-4	7314150139309	1	12
3851-10-0.9-10/14	7311518182823	1	12
3851-10-0.9-H-4	7311518282851	1	12
3851-10-0.9-H-6	7311518282868	1	12
3851-10-0.9-R-14	7314150312399	1	12
3851-13-0.5-10/14	7311518282813	1	12
3851-13-0.5-14/18	7311518282790	1	12
3851-13-0.5-H-4	7311518292072	1	12
3851-13-0.5-R-10	7311518331306	1	12
3851-13-0.5-R-14	7311518331320	1	12
3851-13-0.5-R-18	7311518331344	1	12
3851-13-0.5-R-24	7311518282820	1	12
3851-13-0.6-10/14	7311518183271	1	12
3851-13-0.6-5/8	7311518183233	1	12
3851-13-0.6-6/10	7311518183240	1	12

Code	Code	Code	Code
3851-13-0.6-8/12	7311518185572	1	12
3851-13-0.6-H-3	7311518282769	1	12
3851-13-0.6-H-4	7311518282745	1	12
3851-13-0.6-H-6	7311518282738	1	12
3851-13-0.6-HA-4	7311518282752	1	12
3851-13-0.6-HA-6	7311518282561	1	12
3851-13-0.6-R-10	7311518183110	1	12
3851-13-0.6-R-14	7311518183158	1	12
3851-13-0.6-R-18	7311518183196	1	12
3851-13-0.9-10/14	7311518183868	1	12
3851-13-0.9-6/10	7311518183585	1	12
3851-13-0.9-H-3	7311518282936	1	12
3851-13-0.9-H-4	7311518282943	1	12
3851-13-0.9-H-6	7311518286125	1	12
3851-13-0.9-HA-4	7311518281052	1	12
3851-13-0.9-R-14	7311518182359	1	12
3851-13-0.9-R-6	7311518183301	1	12
3851-20-0.9-10/14	7311518282585	1	12
3851-20-0.9-4/6	7311518183905	1	12
3851-20-0.9-5/8	7311518183929	1	12
3851-20-0.9-6/10	7311518183936	1	12
3851-20-0.9-8/12	7311518282578	1	12
3851-20-0.9-H-3	7314150398515	1	12
3851-20-0.9-H-4	7314150398294	1	12
3851-20-0.9-HA-3	7311518282646	1	12
3851-20-0.9-HA-4	7311518282653	1	12
3851-20-0.9-R-18	7311518332587	1	12
3851-27-0.9-10/14	7311518165475	1	13
3851-27-0.9-2/3	7311518126377	1	13
3851-27-0.9-3/4	7311518126384	1	13
3851-27-0.9-4/6	7311518126391	1	13
3851-27-0.9-5/8	7311518126407	1	13
3851-27-0.9-6/10	7311518126414	1	13
3851-27-0.9-8/12	7311518160692	1	13
3851-27-0.9-HA-3	7311518282684	1	12
3851-27-0.9-HA-4	7314150398317	1	12
3851-27-0.9-P-3	7311518157135	1	12
3851-27-0.9-P-4	7311518157661	1	12
3851-27-0.9-R-6	7311518126353	1	12
3851-34-1.1-2/3	7311518126476	1	13
3851-34-1.1-3/4	7311518126483	1	13
3851-34-1.1-4/6	7311518126490	1	13
3851-34-1.1-5/8	7311518126506	1	13
3851-34-1.1-6/10	7311518165505	1	13
3851-34-1.1-P-2	7311518157715	1	12
3851-34-1.1-P-3	7311518157753	1	12
3851-41-1.3-1.4/2	7311518211837	1	13
3851-41-1.3-2/3	7311518126568	1	13
3851-41-1.3-3/4	7311518126575	1	13
3851-41-1.3-4/6	7311518126582	1	13
3851-41-1.3-5/8	7311518262488	1	13
3851-54-1.3-1.4/2	7314150459360	1	13
3851-54-1.3-2/3	7311518163716	1	13
3851-54-1.3-4/6	7311518168025	1	13
3851-54-1.6-1.4/2	7311518211431	1	13
3851-54-1.6-1/1.4	7311518188542	1	13
3851-54-1.6-2/3	7311518126636	1	13
3851-54-1.6-3/4	7311518126643	1	13
3851-54-1.6-4/6	7314150398539	1	13
3851-54-1.6-P-1.25	7311518158026	1	13
3851-6-0.6-10/14	7311518180652	1	12
3851-6-0.6-H-6	7311518282707	1	12
3851-6-0.9-10/14	7311518180768	1	12
3851-6-0.9-H-6	7311518282714	1	12
3851-67-1.6-7/1	7311518200909	1	13
3851-67-1.6-1.4/2	7314150273317	1	13
3851-67-1.6-1/1.4	7311518178840	1	13
3851-67-1.6-2/3	7311518335243	1	13
3851-67-1.6-3/4	7311518328597	1	13
3851-67-1.6-4/6	7311518194963	1	13
3851-80-1.6-7/1	7311518255367	1	13
3851-80-1.6-1.4/2	7311518255350	1	13
3851-80-1.6-1/1.4	7311518197377	1	13
3853-20-0.9-5/7-VS	7311518331689	1	14
3853-20-0.9-8/11-VS	7311518331702	1	14
3853-27-0.9-3/4	7311518285395	1	14
3853-27-0.9-4/6	7311518183998	1	14
3853-27-0.9-5/7-VS	7311518331115	1	14
3853-27-0.9-5/8	7311518202118	1	14
3853-27-0.9-8/11-VS	7311518331122	1	14
3853-34-1.1-2/3	7311518282875	1	14
3853-34-1.1-3/4	7311518184094	1	14
3853-34-1.1-4/6	7311518184087	1	14
3853-34-1.1-5/7-VS	7311518331726	1	14
3853-34-1.1-5/8	7311518202149	1	14
3853-34-1.1-8/11-VS	7311518331719	1	14
3853-41-1.3-2/3	7311518282882	1	14
3853-41-1.3-2/3-W	7314150370115	1	14
3853-41-1.3-2/3-WS	7314150415113	1	14
3853-41-1.3-3/4	7311518185770	1	14
3853-41-1.3-3/4-W	7311518338053	1	14
3853-41-1.3-3/4-WS	7314150415120	1	14
3853-41-1.3-4/6	7311518184100	1	14
3853-41-1.3-5/7-VS	7311518331733	1	14
3853-41-1.3-5/8	7311518202286	1	14
3853-54-1.3-3/4	7311518184124	1	14

Code	Code	Code	Code
3853-54-1.3-3/4-W	7314150352876	1	14
3853-54-1.3-5/8	7311518197568	1	14
3853-54-1.6-2/3	7311518282899	1	14
3853-54-1.6-2/3-W	7311518338077	1	14
3853-54-1.6-2/3-WS	7314150415151	1	14
3853-54-1.6-3/4	7311518216757	1	14
3853-54-1.6-3/4-W	7311518338091	1	14
3853-54-1.6-3/4-WS	7314150415168	1	14
3853-54-1.6-4/6	7311518222055	1	14
3853-67-1.6-2/3	7311518282905	1	14
3853-67-1.6-2/3-W	7311518338114	1	14
3853-67-1.6-2/3-WS	7314150415175	1	14
3853-67-1.6-3/4	7311518282912	1	14
3853-67-1.6-3/4-W	7311518338138	1	14
3853-67-1.6-3/4-WS	7314150415182	1	14
3853-67-1.6-5/8-W	7311518338152	1	14
3854-27-0.9-PHX-2/3	7314150440603	1	13
3854-27-0.9-PHX-3/4	7314150440610	1	13
3854-27-0.9-PHX-4/6	7314150440627	1	13
3854-27-0.9-PQ-3/4	7314150137480	1	13
3854-27-0.9-PQ-4/6	7314150197828	1	13
3854-34-1.1-PHX-1.4/2	7314150440634	1	13
3854-34-1.1-PHX-2/3	7314150440641	1	13
3854-34-1.1-PHX-3/4	7314150440658	1	13
3854-34-1.1-PHX-4/6	7314150440665	1	13
3854-34-1.1-PQ-2/3	7311518287276	1	13
3854-34-1.1-PQ-3/4	7314150135813	1	13
3854-34-1.1-PQ-4/6	7314150197835	1	13
3854-41-1.3-PHX-1.4/2	7314150440672	1	13
3854-41-1.3-PHX-2/3	7314150440689	1	13
3854-41-1.3-PHX-3/4	7314150440696	1	13
3854-41-1.3-PHX-4/6	7314150440702	1	13
3854-41-1.3-PQ-1.4/2	7314150129355	1	13
3854-41-1.3-PQ-2/3	7311518280604	1	13
3854-41-1.3-PQ-3/4	7311518282950	1	13
3854-41-1.3-PQ-4/6	7314150197842	1	13
3854-54-1.3-PHX-1.4/2	7314150440719	1	13
3854-54-1.3-PHX-2/3	7314150440733	1	13
3854-54-1.3-PHX-3/4	7314150440740	1	13
3854-54-1.6-PHX-7/1	7314150440757	1	13
3854-54-1.6-PHX-1.4/2	7314150440771	1	13
3854-54-1.6-PHX-1/1.4	7314150440764	1	13
3854-54-1.6-PHX-2/3	7314150440788	1	13
3854-54-1.6-PHX-3/4	7314150440795	1	13
3854-54-1.6-PQ-9/1.2	7314150133857	1	13
3854-54-1.6-PQ-1.4/2	7314150127092	1	13
3854-54-1.6-PQ-2/3	7311518265137	1	13
3854-54-1.6-PQ-3/4	7311518282929	1	13
3854-54-1.6-PQ-4/6	7311518330637	1	13
3854-67-1.6-PHX-7/1	7314150440801	1	13
3854-67-1.6-PHX-1.4/2	7314150440825	1	13
3854-67-1.6-PHX-1/1.4	7314150440818	1	13
3854-67-1.6-PHX-2/3	7314150440832	1	13
3854-67-1.6-PQ-9/1.2	7314150133888	1	13
3854-67-1.6-PQ-1.4/2	7314150133901	1	13
3854-67-1.6-PQ-2/3	7311518290160	1	13
3854-80-1.6-PHX-7/1	7314150440849	1	13
3854-80-1.6-PHX-1.4/2	7314150440863	1	13
3854-80-1.6-PHX-1/1.4	7314150440856	1	13
3854-80-1.6-PQ-9/1.2	7314150133959	1	13
3854-80-1.6-PQ-1.4/2	7314150215966	1	13
3857-13-0.6-EZ-L	7311518264789	1	12
3857-13-0.6-EZ-M	7311518264772	1	12
3857-13-0.6-EZ-S	7311518264765	1	12
3857-13-0.6-EZ-S-3P1140	7314150345731	1	143
3857-13-0.6-EZ-S-3P690	7314150345694	1	143
3857-13-0.6-EZ-S-3P730	7314150345700	1	143
3857-13-0.6-EZ-S-3P835	7314150345717	1	143
3857-13-0.6-EZ-S-3P900	7314150345724	1	143
3857-20-0.9-EZ-L	7311518264819	1	12
3857-20-0.9-EZ-M	7311518264802	1	12
3857-20-0.9-EZ-S	7311518264796	1	12
3857-27-0.9-EZ-L	7311518264840	1	12
3857-27-0.9-EZ-M	7311518264833	1	12
3857-27-0.9-EZ-S	7311518264826	1	12
3857-34-1.1-EZ-L	7311518264871	1	12
3857-34-1.1-EZ-M	7311518264864	1	12
3857-34-1.1-EZ-S	7311518264857	1	12
3858-34-1.1-PHX-1.4/2	7314150441198	1	14
3858-34-1.1-PHX-2/3	7314150441204	1	14
3858-34-1.1-PHX-3/4	7314150441211	1	14
3858-41-1.3-PHX-1.4/2	7314150441013	1	14
3858-41-1.3-PHX-2/3	7314150441020	1	14
3858-41-1.3-PHX-3/4	7314150441037	1	14
3858-41-1.3-PQ-1.4/2	7314150395583	1	14
3858-41-1.3-PQ-2/3	7314150395590	1	14
3858-41-1.3-PQ-3/4	7314150395606	1	14
3858-54-1.3-PHX-1.4/2	7314150441068	1	14
3858-54-1.3-PHX-2/3	7314150441044	1	14
3858-54-1.3-PHX-3/4	7314150441051	1	14
3858-54-1.6-PHX-7/1	7314150441075	1	14
3858-54-1.6-PHX-1.4/2	7314150441099	1	14
3858-54-1.6-PHX-1/1.4	7314150441082	1	14
3858-54-1.6-PHX-2/3	7314150441105	1	14
3858-54-1.6-PHX-3/4	7314150441112	1	14
3858-54-1.6-PQ-9/1.2	7314150395613	1	14





3858-54-1.6-PQ-1.4/2	7314150395620	1	14
3858-54-1.6-PQ-2/3	7314150395637	1	14
3858-67-1.6-PHX-7/1	7314150441129	1	14
3858-67-1.6-PHX-1.4/2	7314150441143	1	14
3858-67-1.6-PHX-1/1.4	7314150441136	1	14
3858-67-1.6-PHX-2/3	7314150441150	1	14
3858-67-1.6-PQ-9/1.2	7314150395644	1	14
3858-67-1.6-PQ-1.4/2	7314150395651	1	14
3858-80-1.6-PHX-7/1	7314150441167	1	14
3858-80-1.6-PHX-1.4/2	7314150441181	1	14
3858-80-1.6-PHX-1/1.4	7314150441174	1	14
3858-80-1.6-PQ-9/1.2	7314150395668	1	14
3859-27-0.9-EZX-3/4	7314150517558	1	15
3859-27-0.9-EZX-4/6	7314150517565	1	15
3859-34-1.1-EZX-2/3	7314150517572	1	15
3859-34-1.1-EZX-3/4	7314150517589	1	15
3859-34-1.1-EZX-4/6	7314150517596	1	15
3859-41-1.3-EZX-1.4/2	7314150517602	1	15
3859-41-1.3-EZX-2/3	7314150517619	1	15
3859-41-1.3-EZX-3/4	7314150517626	1	15
3859-41-1.3-EZX-4/6	7314150517633	1	15
3859-54-1.6-EZX-1.4/2	7314150517640	1	15
3859-54-1.6-EZX-1/1.25	7314150517657	1	15
3859-54-1.6-EZX-2/3	7314150517664	1	15
3859-54-1.6-EZX-3/4	7314150517671	1	15
3859-54-1.6-EZX-4/6	7314150517688	1	15
3859-67-1.6-EZX-7/1	7314150517695	1	15
3859-67-1.6-EZX-1.4/2	7314150517701	1	15
3859-67-1.6-EZX-1/1.25	7314150517718	1	15
3859-67-1.6-EZX-2/3	7314150517725	1	15
3859-80-1.6-EZX-7/1	7314150517732	1	15
3859-80-1.6-EZX-1.4/2	7314150517749	1	15
3859-80-1.6-EZX-1/1.25	7314150517756	1	15
386-6T	7311518152017	4	644
3860-100-1.1-TMC-1.4/2	7314150336968	1	16
3860-27-0.9-TC-3	7314150413010	1	16
3860-27-0.9-TC-3/4	7314150413027	1	16
3860-27-0.9-TC-3/4	7314150263493	1	16
3860-34-1.1-TC-2/3	7314150413034	1	16
3860-34-1.1-TC-3/4	7314150413041	1	16
3860-34-1.1-TC-3/4-W	7314150413058	1	16
3860-34-1.1-TC-2/3	7311518330880	1	16
3860-34-1.1-TC-3/4	7311518330897	1	16
3860-41-1.3-TC-1.4/2	7314150413065	1	16
3860-41-1.3-TC-1.9/2.1	7314150413072	1	16
3860-41-1.3-TC-2/3	7314150413089	1	16
3860-41-1.3-TC-3/4	7314150413096	1	16
3860-41-1.3-TC-2/3	7311518330903	1	16
3860-41-1.3-TC-3/4	7311518330910	1	16
3860-41-1.3-TMC-1.4/2	7314150129379	1	16
3860-41-1.3-TMC-2/3	7311518330224	1	16
3860-54-1.3-TMC-1.4/2	7314150288748	1	16
3860-54-1.3-TMC-2/3	7311518335267	1	16
3860-54-1.6-TC-1.4/2	7314150413119	1	16
3860-54-1.6-TC-1.9/2.1	7314150413133	1	16
3860-54-1.6-TC-2/3	7314150413140	1	16
3860-54-1.6-TC-3/4	7314150413157	1	16
3860-54-1.6-TMC-7/1	7314150263431	1	16
3860-54-1.6-TMC-1.4/2	7314150137978	1	16
3860-54-1.6-TMC-1.4/2S	7314150395316	1	17
3860-54-1.6-TMC-1/1.25	7314150154340	1	16
3860-54-1.6-TMC-1/1.25S	7314150395309	1	17
3860-54-1.6-TMC-2/3	7314150189366	1	16
3860-54-1.6-TMC-2/3S	7314150395323	1	17
3860-67-1.6-TC-1.4/2	7314150413164	1	16
3860-67-1.6-TC-1/1.25	7314150413171	1	16
3860-67-1.6-TMC-1.4/2	7314150137985	1	16
3860-67-1.6-TMC-1.4/2S	7314150395347	1	17
3860-67-1.6-TMC-1/1.25	7314150154364	1	16
3860-67-1.6-TMC-1/1.25S	7314150395330	1	17
3860-67-1.6-TMC-2/3	7314150189359	1	16
3860-80-1.1-TMC-1.4/2	7314150382767	1	16
3860-80-1.6-TC-5/0.8	7314150413188	1	16
3860-80-1.6-TMC-7/1	7314150154371	1	16
3860-80-1.6-TMC-1.4/2	7314150182992	1	16
3860-80-1.6-TMC-1/1.25	7314150182336	1	16
3860-80-1.6-TMC-2/3	7314150215959	1	16
3861-20-0.6-H-4	7311518331351	1	18
3861-27-0.9-H-1.33	7311518329716	1	18
3861-34-0.9-H-1.15	7311518258894	1	18
3861-34-1.1-H-1.15	7311518258900	1	18
3861-41-1.1-H-1.15	7314150129294	1	18
3861-54-1.1-H-1.15	7314150129270	1	18
3862-33-0.9-H-1.15	7314150320325	1	18
3862-33-1.1-H-1.15	7311518331269	1	18
3862-40-1.1-H-1.15	7311518331283	1	18
3868-27-0.9-TSS-3/4	7314150447633	1	15
3868-27-0.9-TSX-3/4	7311518329693	1	15
3868-34-1.1-TSS-2/3	7311518329266	1	15
3868-34-1.1-TSX-2	7311518203016	1	15
3868-34-1.1-TSX-2/3	7311518255343	1	15
3868-34-1.1-TSX-3/4	7311518232375	1	15
3868-41-1.3-TSS-1.4/2	7311518243142	1	15
3868-41-1.3-TSS-2/3	7311518270643	1	15
3868-41-1.3-TSX-1.4/2	7311518214210	1	15
3868-41-1.3-TSX-1.6	7311518203092	1	15



3868-41-1.3-TSX-2	7311518203085	1	15
3868-41-1.3-TSX-2/3	7311518232382	1	15
3868-41-1.3-TSX-3/4	7311518232399	1	15
3868-54-1.3-TSX-1.4/2	7311518214876	1	15
3868-54-1.3-TSX-2/3	7314150416394	1	15
3868-54-1.6-TSS-1.4/2	7311518243166	1	15
3868-54-1.6-TSS-1/1.25	7311518243173	1	15
3868-54-1.6-TSS-2/3	7311518280383	1	15
3868-54-1.6-TSX-1.4/2	7311518214869	1	15
3868-54-1.6-TSX-1.6	7311518203108	1	15
3868-54-1.6-TSX-1/1.25	7311518213114	1	15
3868-54-1.6-TSX-2/3	7311518232405	1	15
3868-54-1.6-TSX-3/4	7311518270360	1	15
3868-67-1.6-TSS-7/1	7311518274115	1	15
3868-67-1.6-TSS-1.4/2	7311518243197	1	15
3868-67-1.6-TSS-1/1.25	7311518243180	1	15
3868-67-1.6-TSS-2/3	7311518328825	1	15
3868-67-1.6-TSX-7/1	7311518212865	1	15
3868-67-1.6-TSX-1.4/2	7311518265496	1	15
3868-67-1.6-TSX-1/1.25	7311518213084	1	15
3868-67-1.6-TSX-2/3	7314150203536	1	15
3868-80-1.1-TSX-3/4	7311518330200	1	15
3868-80-1.6-TSS-7/1	7314150216253	1	15
3868-80-1.6-TSS-1.4/2	7314150203529	1	15
3868-80-1.6-TSS-2/3	7314150398553	1	15
3868-80-1.6-TSX-7/1	7311518212872	1	15
3868-80-1.6-TSX-1.4/2	7314150342167	1	15
3868-80-1.6-TSX-1/1.25	7314150277278	1	15
3868-80-1.6-TSX-2/3	7314150203543	1	15
3869-13-0.9-TS-3	7311518200589	1	15
3869-20-0.9-TS-3	7311518177300	1	15
3869-20-0.9-TS-4	7311518197742	1	15
3869-27-0.9-TS-3	7311518177348	1	15
3869-27-0.9-TS-4	7311518182595	1	15
3869-34-1.1-TS-2	7314150330508	1	15
3869-34-1.1-TS-3	7311518177355	1	15
3870-BRUSH-100-10	7311518269876	4	18
3870-BRUSH-100-10-HEX	7311518333935	4	18
3870-BRUSH-100-12	7311518269883	4	18
3870-BRUSH-100-13	7314150321131	1	18
3870-BRUSH-60-6	7311518279523	4	18
3870-BRUSH-80-10	7311518278311	4	18
3870-BRUSH-80-6	7311518269906	4	18
3870-BRUSH-80-8	7311518269890	4	18
3870-REFRACTOMETER	7311518192129	1	18
3870-TACHO METER	7311518145620	1	18
3870-TENSION METER	7311518145637	1	18
3870-WEDGE-3	7311518262747	1	19
3870-WHEEL	7314150398652	1	19
3875-BP1	7314150187737	8	482
3875-BP2	7314150187744	8	482
3875-GLOVE	7314150353330	5	499
3875-HB10	7314150349777	1	481
3875-HB100	7314150289783	1	482
3875-HB30	7314150187720	1	482
3875-HB60	7314150187713	8	482
3875-LY1	7314150191253	8	480
3875-LY10	7314150315062	1	481
3875-LY2	7314150191260	8	480
3875-LY3	7314150191284	8	480
3875-LY4	7314150262878	8	480
3875-LY60	7314150436521	1	480
3875-LY70	7314150442751	1	480
3875-LY8	7314150309689	1	481
3875-MHP4	7314150187805	1	482
3875-MHP6	7314150187812	1	482
3875-QL1	7314150191307	8	480
3875-QRL1	7314150194797	1	480
3875-RL1	7314150194780	1	480
3875-RL2	7314150312948	1	480
3875-SB70	7314150326839	1	482
3875-SL1	7314150220106	1	481
3875-WL1	7314150191291	8	480
3881-100-1.6-THS-7/1	7311518329617	1	16
3881-34-1.1-THQ-2/3	7311518265793	1	16
3881-41-1.3-THQ-1.4/2	7314150129447	1	16
3881-41-1.3-THQ-2/3	7314150129454	1	16
3881-41-1.3-THS-1.4/2	7311518273712	1	16
3881-54-1.6-THQ-1.4/2	7314150128860	1	16
3881-54-1.6-THQ-1/1.25	7314150342181	1	16
3881-54-1.6-THQ-2/3	7314150138739	1	16
3881-54-1.6-THS-1.4/2	7314150138784	1	16
3881-54-1.6-THS-1/1.25	7311518269050	1	16
3881-67-1.6-THQ-1.4/2	7314150120369	1	16
3881-67-1.6-THQ-1/1.25	7314150180097	1	16
3881-67-1.6-THQ-2/3	7311518328832	1	16
3881-67-1.6-THS-1.4/2	7314150138791	1	16
3881-67-1.6-THS-1/1.25	7311518269043	1	16
3881-67-1.6-THS-2/3	7311518328849	1	16
3881-80-1.6-THQ-7/1	7311518332938	1	16
3881-80-1.6-THQ-1.4/2	7311518328856	1	16
3881-80-1.6-THQ-1/1.25	7314150133918	1	16
3881-80-1.6-THQ-2/3	7311518328863	1	16
3881-80-1.6-THS-7/1	7311518279202	1	16
3881-80-1.6-THS-1.4/2	7314150195312	1	16
3881-80-1.6-THS-2/3	7314150215942	1	16



38A-08	7314150433469	25	331
38A-10	7314150431564	25	331
38A-12	7314150237944	1	331
38A-15	7314150237951	25	331
38A-21	7314150237968	1	331
38A-26	7314150237975	1	331
38C-26	7314150237982	1	331
39-24	7314151831301	1	331
3905-250-24-100	7311518299255	100	572
3905-300-14-100	7311518292201	100	572
3905-300-18-100	7311518292218	100	572
3905-300-24-100	7311518292225	100	572
3905-300-24-2P	7311518299248	10	572
3905-300-32-100	7311518292232	100	572
3906-250-18-100	7311518250997	100	571
3906-250-18-5P	7314150265534	10	571
3906-250-24-100	7311518251000	100	571
3906-250-24-5P	7314150265541	10	571
3906-250-32-100	7311518251017	100	571
3906-250-32-5P	7314150265558	10	571
3906-300-14-100	7311518233563	100	571
3906-300-14-10P	7311518233693	10	571
3906-300-14-5P	7314150265565	10	571
3906-300-18-100	7311518233570	100	571
3906-300-18-10P	7311518233723	10	571
3906-300-18-2P	7311518233617	10	571
3906-300-18-5P	7314150265572	10	571
3906-300-24-100	7311518233587	100	571
3906-300-24-10P	7311518233730	10	571
3906-300-24-2P	7311518233624	10	571
3906-300-24-5P	7311518237417	10	571
3906-300-32-100	7311518233594	100	571
3906-300-32-10P	7311518233747	10	571
3906-300-32-2P	7311518233631	10	571
3906-300-32-5P	7311518237424	10	571
3906-300-3P	7311518233754	10	571
3911-115-IM-10P	7314150485703	10	142
3911-115-T41-AL	7314150485642	25	142
3911-115-T41-I	7314150454570	25	142
3911-115-T41-IM	7314150454587	50	142
3911-115-T42-M	7314150454679	25	142
3911-115T41-IM	7314150460595	50	142
3911-125-IM-10P	7314150485680	10	142
3911-125-T41-AL	7314150485666	25	142
3911-125-T41-I	7314150454594	25	142
3911-125-T41-IM	7314150454600	50	142
3911-125-T42-M	7314150454686	25	142
3911-125T41-IM	7314150485444	25	142
3911-150-T41-I	7314150454624	50	142
3911-150-T42-M	7314150454709	25	142
3911-180-T41-I	7314150454631	50	142
3911-180-T41-IM	7314150454655	50	142
3911-180-T42-M	7314150454693	25	142
3911-180T41-IM	7314150485468	50	142
3911-230-T41-I	7314150454648	50	142
3911-230-T41-IM	7314150454662	50	142
3911-230-T42-M	7314150454716	50	142
3911-230T41-IM	7314150485482	50	142
3911-230T41-IM	7314150485628	50	142
3911-350-X2TM	7314150486366	35	142
3911-400-F2TM	7314150485963	15	142
3911-400-X2TM	7314150502967	15	142
3912-115-T41-IM	7314150454808	50	142
3912-115-T42-ST	7314150454723	25	142
3912-125-T41-IM	7314150454815	50	142
3912-125-T42-ST	7314150454730	25	142
3912-180-T42-ST	7314150454747	25	142
3912-230-T42-ST	7314150454754	50	142
3916-115-10P-CE	7314150455348	100	143
3916-115-10S-UE	7314150455270	100	143
3916-125-10P-CE	7314150455355	100	143
3916-125-10S-UE	7314150455287	100	143
3916-150-10S-UE	7314150455294	50	143
3916-180-10S-UE	7314150455300	50	143
3916-230-10L-RC	7314150455232	25	143
3916-230-10S-UE	7314150455317	25	143
3917-115-7S-C	7314150455324	100	143
3917-115-7S-U	7314150455249	100	143
3917-125-7S-C	7314150455331	100	143
3917-125-7S-U	7314150455256	100	143
3917-230-7S-U	7314150455263	25	143
3921-115-T27-IM	7314150454617	25	142
3921-125-T27-IM	7314150454761	25	142
3921-150-T27-IM	7314150454778	25	142
3921-180-T27-IM	7314150454785	25	142
3921-230-T27-IM	7314150454792	25	142
3926-115IM-C120	7314150454860	20	143
3926-115IM-C40	7314150454839	20	143
3926-115IM-C60	7314150454846	20	143
3926-115IM-C80	7314150454853	20	143
3926-125IM-C120	7314150454914	20	143
3926-125IM-C40	7314150454884	20	143
3926-125IM-C60	7314150454891	20	143
3926-125IM-C80	7314150454907	20	143
3927-115IM-P120	7314150454952	20	143
3927-115IM-P40	7314150454921	20	143



3927-115IM-P60	7314150454938	20	143
3927-115IM-P80	7314150454945	20	143
3927-125-120-3P	7314150499007	12	143
3927-125-40-3P	7314150498949	12	143
3927-125-60-3P	7314150498963	12	143
3927-125-80-3P	7314150498987	12	143
3927-125IM-P120	7314150455010	20	143
3927-125IM-P40	7314150454976	20	143
3927-125IM-P60	7314150454983	20	143
3927-125IM-P80	7314150455003	20	143
3940-100-14-SC-2P	7314150364466	10	134
3940-100-14-SC-5P	7314150364473	5	134
3940-100-14-ST-10P	7314150364336	1	134
3940-100-14-ST-2P	7314150364312	10	134
3940-100-14-ST-5P	7314150364329	5	134
3940-100-18-SC-2P	7314150364442	10	134
3940-100-18-SC-5P	7314150364459	5	134
3940-100-18-ST-10P	7314150364367	1	134
3940-100-18-ST-2P	7314150364343	10	134
3940-100-18-ST-5P	7314150364350	5	134
3940-100-24-SC-2P	7314150364558	10	134
3940-100-24-SC-5P	7314150364565	5	134
3940-100-24-ST-10P	7314150364435	1	134
3940-100-24-ST-2P	7314150364411	10	134
3940-100-24-ST-5P	7314150364428	5	134
3940-150-10-HST-10P	7314150364039	1	134
3940-150-10-HST-2P	7314150364015	10	134
3940-150-10-HST-5P	7314150364022	5	134
3940-150-10-ST-100P	7314150362196	1	134
3940-150-10-ST-10P	7314150362189	1	134
3940-150-10-ST-2P	7314150362165	10	134
3940-150-10-ST-5P	7314150362172	5	134
3940-150-14-HST-10P	7314150362370	1	134
3940-150-14-HST-2P	7314150362325	10	134
3940-150-14-HST-5P	7314150362363	5	134
3940-150-14-ST-100P	7314150364183	1	134
3940-150-14-ST-10P	7314150364176	1	134
3940-150-14-ST-2P	7314150364152	5	134
3940-150-14-ST-5P	7314150364169	5	134
3940-150-18-HST-10P	7314150364060	1	134
3940-150-18-HST-2P	7314150364046	10	134
3940-150-18-HST-5P	7314150364053	5	134
3940-150-18-ST-100P	7314150364107	1	134
3940-150-18-ST-10P	7314150364091	1	134
3940-150-18-ST-2P	7314150364077	10	134
3940-150-18-ST-5P	7314150364084	5	134
3940-150-24-ST-100P	7314150364404	1	134
3940-150-24-ST-10P	7314150364398	1	134
3940-150-24-ST-2P	7314150364374	5	134
3940-150-24-ST-5P	7314150364381	5	134
3940-150-4/6-SC-10P	7314150361847	1	135
3940-150-4/6-SC-2P	7314150361823	10	135
3940-150-4/6-SC-5P	7314150361830	5	135
3940-150-5/8-DSL-10P	7314150361991	1	135
3940-150-5/8-DSL-2P	7314150361977	10	135
3940-150-5/8-DSL-5P	7314150361984	5	135
3940-150-5/8-SL-100P	7314150361724	1	135
3940-150-5/8-SL-10P	7314150361717	1	135
3940-150-5/8-SL-2P	7314150361687	10	135
3940-150-5/8-SL-5P	7314150361700	5	135
3940-150-6-ST-10P	7314150361786	1	135
3940-150-6-ST-2P	7314150361762	10	135
3940-150-6-ST-5P	7314150361779	5	135
3940-150-8/12-ST-100P	7314150362158	1	134
3940-150-8/12-ST-10P	7314150362141	1	134
3940-150-8/12-ST-2P	7314150362127	10	134
3940-150-8/12-ST-5P	7314150362134	5	134
3940-228-10-DSL-100P	7314150362035	1	135
3940-228-10-DSL-10P	7314150362028	1	135
3940-228-10-DSL-2P	7314150362004	10	135
3940-228-10-DSL-5P	7314150362011	5	135
3940-228-10-HST-100P	7314150362417	1	134
3940-228-10-HST-10P	7314150362400	1	134
3940-228-10-HST-2P	7314150362387	10	134
3940-228-10-HST-5P	7314150362394	5	134
3940-228-10-PR09-100P	7314150361625	1	135
3940-228-10-ST-100P	7314150362110	1	134
3940-228-10-ST-10P	7314150362103	1	134
3940-228-10-ST-2P	7314150362080	10	134
3940-228-10-ST-5P	7314150362097	5	134
3940-228-10/14-PR09-100P	7314150361526	1	135
3940-228-10/14-PR09-10P	7314150361519	1	135
3940-228-10/14-PR13-100P	7314150361649	1	135
3940-228-10/14-PR13-10P	7314150451265	1	135
3940-228-14-HST-10P	7314150362226	1	134
3940-228-14-HST-2P	7314150362202	10	134
3940-228-14-HST-5P	7314150362219	5	134
3940-228-14-ST-100P	7314150364145	1	134
3940-228-14-ST-10P	7314150364138	1	134
3940-228-14-ST-2P	7314150364114	10	134
3940-228-14-ST-5P	7314150364121	5	134
3940-228-18-HST-10P	7314150362271	1	134
3940-228-18-HST-2P	7314150362233	10	134
3940-228-18-HST-5P	7314150362264	5	134
3940-228-18-ST-100P	7314150364220	1	134
3940-228-18-ST-10P	7314150364213	1	134



3940-228-18-ST-2P



3940-228-18-ST-2P	7314150364190	10	134
3940-228-18-ST-5P	7314150364206	5	134
3940-228-5/8-DSL-10P	7314150361939	1	135
3940-228-5/8-DSL-2P	7314150361915	10	135
3940-228-5/8-DSL-5P	7314150361922	5	135
3940-228-6-SL-10P	7314150361755	1	135
3940-228-6-SL-2P	7314150361731	10	135
3940-228-6-SL-5P	7314150361748	5	135
3940-228-8/12-PR13-100P	7314150361601	1	135
3940-228-8/12-ST-100P	7314150362073	1	134
3940-228-8/12-ST-10P	7314150362066	1	134
3940-228-8/12-ST-2P	7314150362042	10	134
3940-228-8/12-ST-5P	7314150362059	5	134
3940-300-10-HST-10P	7314150362448	1	134
3940-300-10-HST-2P	7314150362424	10	134
3940-300-10-HST-5P	7314150362431	5	134
3940-300-14-HST-10P	7314150362301	1	134
3940-300-14-HST-2P	7314150362288	10	134
3940-300-14-HST-5P	7314150362295	5	134
3940-300-14-ST-100P	7314150364268	1	134
3940-300-14-ST-10P	7314150364251	1	134
3940-300-14-ST-2P	7314150364237	5	134
3940-300-14-ST-5P	7314150364244	5	134
3940-300-18-HST-10P	7314150364008	1	134
3940-300-18-HST-2P	7314150363988	10	134
3940-300-18-HST-5P	7314150363995	5	134
3940-300-18-ST-100P	7314150364305	1	134
3940-300-18-ST-10P	7314150364299	1	134
3940-300-18-ST-2P	7314150364275	10	134
3940-300-18-ST-5P	7314150364282	5	134
3940-300-5/8-DSL-10P	7314150361960	1	135
3940-300-5/8-DSL-2P	7314150361946	10	135
3940-300-5/8-DSL-5P	7314150361953	5	135
3940-300-6-SL-10P	7314150361816	1	135
3940-300-6-SL-2P	7314150361793	10	135
3940-300-6-SL-5P	7314150361809	5	135
3940-300-8/12-SL-100P	7314150361908	1	135
3940-300-8/12-SL-10P	7314150361892	1	135
3940-300-8/12-SL-2P	7314150361878	5	135
3940-300-8/12-SL-5P	7314150361885	5	135
3940-HDD-SET-5P	7314150401703	5	137
3940-METAL-SET-12P	7314150511488	6	137
3940-METAL-SET-5P	7314150401673	5	137
3940-MIX-SET-10P	7314150401666	4	137
3940-MIX-SET-12P	7314150511501	6	137
3940-MIX-SET-5P	7314150401659	5	137
3942-150-7-SL-10P	7314150364534	1	136
3942-150-7-SL-2P	7314150364510	10	136
3942-150-7-SL-5P	7314150364527	5	136
3942-228-11-HSL-10P	7314150364831	1	136
3942-228-11-HSL-2P	7314150364817	10	136
3942-228-11-HSL-5P	7314150364824	5	136
3942-228-5-HSL-10P	7314150364657	1	136
3942-228-5-HSL-2P	7314150364633	10	136
3942-228-5-HSL-5P	7314150364640	5	136
3942-228-7-HSL-10P	7314150364749	1	136
3942-228-7-HSL-2P	7314150364725	10	136
3942-228-7-HSL-5P	7314150364732	5	136
3942-228-7-SL-10P	7314150364503	1	136
3942-228-7-SL-2P	7314150364480	10	136
3942-228-7-SL-5P	7314150364497	5	136
3942-300-5-HSL-10P	7314150364688	1	136
3942-300-5-HSL-2P	7314150364664	10	136
3942-300-5-HSL-5P	7314150364671	5	136
3942-300-7-HSL-10P	7314150364770	1	136
3942-300-7-HSL-2P	7314150364756	10	136
3942-300-7-HSL-5P	7314150364763	5	136
3942-300-7-SL-10P	7314150364619	1	136
3942-300-7-SL-2P	7314150364596	10	136
3942-300-7-SL-5P	7314150364602	5	136
3942-WOOD-SET-12P	7314150511525	6	137
3942-WOOD-SET-5P	7314150401680	5	137
3943-C30-JT-F	7314150422869	10	136
3943-C30-JT-M	7314150422876	10	136
3943-C35-JT-C	7314150422937	10	136
3943-C35-JT-M	7314150422883	10	136
3943-R28-UT-C-2P	7314150422951	10	137
3943-S20-JT-F	7314150422944	10	136
3944-300-3-MEAT-1P	7314150364862	10	138
3946-100-DG-ST-2P	7314150478644	10	135
3946-150-10-HST-1P	7314150478156	10	135
3946-150-6-DSL-1P	7314150478101	10	136
3946-150-6-SL-1P	7314150364916	5	138
3946-150-8-HST-1P	7314150478132	10	135
3946-150-DG-ST-2P	7314150478668	10	135
3946-228-10-HST-1P	7314150478255	10	135
3946-228-3-ST-1P	7314150364886	5	138
3946-228-6-DSL-1P	7314150478217	10	136
3946-228-8-HST-1P	7314150478231	10	135
3946-300-10-HST-1P	7314150478323	10	135
3946-300-2-CB-1P	7314150478354	10	138
3946-300-6-DSL-1P	7314150478286	10	136
3946-300-6-ST-1P	7314150364923	5	138
3946-300-8-HST-1P	7314150478309	10	135
3946-457-2-CB-1P	7314150478378	10	138
396-BLADE	7311518299057	100	649



396-BLADE-1P	7311518330613	1	649
396-HP	7311518152284	4	649
396-HP-BLADE	7311518156404	300	650
396-INS	7314150422708	10	575
396-JS	7311518223250	4	649
396-JS-BLADE	7311518223267	300	650
396-JT	7311518168056	4	649
396-JT-BLADE	7311518168063	300	650
396-LAP	7311518172367	10	649
4-138-06-1-0	7311518020927	10	27
4-138-06-1-2	7311518000592	5	27
4-138-08-1-0	7311518020934	10	27
4-138-08-1-2	7311518000615	5	27
4-138-10-1-0	7311518020958	10	27
4-138-10-1-2	7311518000646	5	27
4-138-12-1-0	7311518020965	5	27
4-138-12-1-2	7311518194734	5	27
4-140-06-1-0	7311518020989	10	27
4-140-08-1-0	7311518020996	10	27
4-140-08-1-2	7311518028169	5	27
4-140-10-1-0	7311518022488	10	27
4-140-10-1-2	7311518194741	5	27
4-142-06-1-0	7311518021016	10	27
4-142-08-1-0	7311518021023	10	27
4-142-10-1-0	7311518021030	10	27
4-144-08-2-0	7311518021054	10	28
4-144-08-2-2	7311518201319	5	28
4-152-08-2-2	7311518000691	5	28
4-153-08-1-2	7311518000707	5	28
4-154-08-2-2	7311518000714	10	28
4-155-08-2-0	7311518116194	10	28
4-155-10-2-0	7311518116200	5	28
4-183-04-2-0	7311518021108	10	28
4-183-04-2-2	7311518201401	5	28
4-183-05-2-0	7311518021122	10	28
4-183-05-2-2	7311518201418	5	28
4-183-06-2-0	7311518021139	10	28
4-183-06-2-2	7311518000769	5	28
4-183-07-2-0	7311518021146	10	28
4-183-07-2-2	7311518194710	5	28
4-183-08-2-0	7311518021153	10	28
4-183-08-2-2	7311518194727	5	28
4-183-10-2-0	7311518021160	10	28
4-183-45-2-0	7311518021115	10	28
4-186-04-2-0	7311518021191	10	28
4-186-04-2-2	7311518201425	5	29
4-186-05-2-0	7311518021214	10	28
4-186-05-2-2	7311518028213	5	29
4-186-06-2-0	7311518021221	10	28
4-186-06-2-2	7311518000837	5	29
4-186-07-2-0	7311518021238	10	28
4-186-08-2-0	7311518021245	10	28
4-186-45-2-0	7311518021207	10	28
4-187-04-2-0	7311518021269	10	29
4-187-05-2-0	7311518021283	10	29
4-187-05-2-2	7311518201449	5	29
4-187-06-2-0	7311518021290	10	29
4-187-06-2-2	7311518022464	5	29
4-187-07-2-0	7311518021306	10	29
4-187-45-2-0	7311518021276	10	29
4-188-05-2-0	7311518021337	10	29
4-188-05-2-2	7311518201456	5	29
4-188-06-2-0	7311518021344	10	29
4-190-06-2-2	7311518000899	5	29
4-190-07-2-0	7311518021375	10	29
4-190-07-2-2	7311518000905	5	29
4-190-08-2-0	7311518021382	10	29
4-190-08-2-2	7311518000912	5	29
4-192-06-2-0	7311518021412	10	29
4-192-06-2-2	7311518201463	5	29
4-192-07-2-0	7311518021429	10	29
4-192-08-2-0	7311518021436	10	29
4-192-08-2-2	7311518201487	5	29
4-202-85-2-0	7311518021474	10	30
4-204-85-2-0	7311518021498	10	30
4-272-05-3-2	7311518201500	5	30
4-272-06-3-0	7311518021597	10	30
4-272-06-3-2	7311518001025	5	30
400.002.050	7314150249848	1	623
400.003.020	8412814403205	1	623
400.003.030	8412814403304	1	623
401-16	7314150400270	12	268
401-28	7314150384082	12	268
402-15-95	7314150485604	1	269
402-35	7314150384099	6	268
402-76	7314150384105	6	268
402-95-SET	7314150400997	1	269
4020L-M-3	7314151077693	5	43
4020L-M-3.2	7314151405038	5	43
4020L-M-3.5	7314151077709	5	43
4020L-M-4	7314151077716	5	43
4020L-M-4.5	7314151077723	5	43
4020L-M-5	7314151077730	5	43
4020L-M-5.5	7314151077747	5	43
4040M-10-11	7314151078287	1	59
4040M-10-13	7314153000750	1	59



4040M-12-13	7314151078294	1	59
4040M-13-17	7314151804565	1	59
4040M-14-15	7314151078300	1	59
4040M-16-17	7314151078317	1	59
4040M-16-18	7314151839635	1	59
4040M-17-19	7314151804572	1	59
4040M-18-19	7314151078324	1	59
4040M-20-22	7314151078331	1	59
4040M-21-23	7314151078348	1	59
4040M-24-27	7314151831974	1	59
4040M-6-7	7314151831967	1	59
4040M-8-9	7314151078270	1	59
4040M/6T	7314150112197	1	59
4040M/S6	7314150112180	1	59
4040Z-1/2-9/16	7314151831998	1	59
4040Z-13/16-7/8	7314150355099	1	59
4040Z-3/8-7/16	7314151831981	1	59
4040Z-5/8-11/16	7314151832001	1	59
4040Z-5/8-3/4	73141503001023	1	59
405-1000	7314150399758	5	554
405-1000-M	7314150399765	5	554
405-400	7314150399673	5	554
405-400-M	7314150399680	5	554
405-600	7314150399697	5	554
405-600-M	7314150399703	5	554
405-800	7314150399710	10	554
405-800-M	7314150399741	5	554
405L-400	7314150400461	10	554
405L-400-M	7314150400492	5	554
405L-600	7314150400478	10	554
405L-600-M	7314150400485	5	554
406-300	7314150183678	1	554
406-300-M	7314150186358	5	554
406-400	7314150183685	5	554
406-400-M	7314150183838	5	554
406-500	7314150183692	5	554
406-500-M	7314150186365	5	554
406-600	7314150245819	5	554
406-600-M	7314150245840	5	554
406-800	7314150245826	5	554
406P-400	7314150302574	10	554
406P-600	7314150302581	10	554
406T-225	7314150315130	10	555
407-1000	7314150369928	6	609
407-1400	7314150373703	6	609
407-700	7314150369911	6	609
407F-1000	7314150383801	5	609
407F-1400	7314150383818	6	609
407F-700	7314150383795	6	609
40B-115-165	7314153011879	25	60
40B-115-165-SP	7314153024459	1	60
40B-150-230	7314153024534	8	60
40B-19-50	7314153011848	25	60
40B-19-50-SP	7314153024473	1	60
40B-32-75	7314153011855	25	60
40B-32-75-SP	7314153024497	1	60
40B-50-120	7314153011862	20	60
40B-50-120-SP	7314153024510	1	60
4106-115-165	7314153024572	25	60
4106-150-230	7314153024596	8	60
4106-19-50	7314153011886	25	60
4106-32-75	7314153011893	25	60
4106-50-120	7314153024558	20	60
411-26	7314150412068	4	270
411-26-95	7314150412259	50	270
411-35	7314150412082	4	270
411-35-95	7314150412266	50	270
411-42	7314150412112	6	270
411-42-95	7314150412273	50	270
411-63	7314150412136	5	270
411-63-95	7314150412280	30	270
412-26-MULTI	7314150412174	5	270
412-26-MULTI-95	7314150412303	150	270
412-28-PEX	7314150412150	5	270
412-28-PEX-95	7314150412297	30	270
4124-JT-H	7311518267803	4	649
4128-JT-H	7311518267810	4	649
4130	7314150100019	3	233
413005000	8413345011860	12	612
413010000	8413345011877	12	612
413015000	8413345011884	12	612
413020000	8413345011891	6	612
413030000	8413345119986	1	612
413040000	8413345119993	1	612
4131	7314150100026	3	233
414-10	7311518238148	4	585
414-12	7311518238155	4	585
414-14	7311518238162	4	585
414-15	7311518238179	4	585
414-16	7311518238186	4	585
414-18	7311518238193	4	585
414-20	7311518238209	4	585
414-22	7311518238216	4	585
414-25	7311518238223	4	585
414-28	7311518238230	4	585
414-30	7311518238247	4	585



414-32	7311518238254	4	585
414-35	7311518238261	4	585
414-38	7311518238278	4	585
414-6	7311518238117	4	585
414-8	7311518238131	4	585
414-S3-EUR	7311518249205	1	585
416-1000	7314150314027	10	554
416-1200	7314150308798	10	554
416-1500	7314150314034	10	554
416-1800	7314150308804	10	554
416-2000	7314150308811	10	554
416-400	7314150314003	10	554
416-600	7314150308781	10	554
416-800	7314150314010	10	554
416-SET-1	7314150308828	5	555
416-SET-2	7314150308835	5	555
416-SET+ BAG	7314150365470	1	554
41RM-10	7314153014429	1	45
41RM-11	7314153014436	1	45
41RM-12	7314153014443	1	45
41RM-13	7314153014450	1	45
41RM-14	7314153014467	1	45
41RM-17	7314153014474	1	45
41RM-19	7314153014481	1	45
41RM-21	7314150219742	1	45
41RM-8	7314153014412	1	45
41RM/SH8	7314150220656	10	46
41RZ-1/2	7314150359011	1	45
41RZ-11/16	7314150359042	1	45
41RZ-13/16	7314150359066	1	45
41RZ-3/4	7314150359059	1	45
41RZ-3/8	7314150358991	1	45
41RZ-5/16	7314150358984	1	45
41RZ-5/8	7314150359035	1	45
41RZ-7/16	7314150359004	1	45
41RZ-7/8	7314150359073	1	45
41RZ-9/16	7314150359028	1	45
420SC-25	7314150169825	10	603
420SC-50	7314150169832	5	603
420SH-100-200	7314150359691	10	602
420SH-120-1000	7314150359790	6	602
420SH-120-1250	7314150359806	6	602
420SH-120-1500	7314150359813	6	602
420SH-120-250	7314150359707	8	602
420SH-120-300	7314150359745	8	602
420SH-120-400	7314150359752	6	602
420SH-120-500	7314150359769	6	602
420SH-120-600	7314150359776	6	602
420SH-120-800	7314150359783	6	602
420SH-140-400	7314150359820	6	602
420SH-175-400	7314150359837	6	602
420SH-50-100	7314150359646	10	602
420SH-50-200	7314150359653	10	602
420SH-60-120	7314150359660	12	602
420SH-60-300	7314150359677	12	602
420SH-80-160	7314150359684	12	602
4211-11-6T	7311518152000	4	649
4211-14-6T	7311518128883	4	649
4212-11-6T	7311518002060	4	649
4212-14-6T	7311518002077	4	649
422P-10	7311518248369	4	586
422P-12	7311518248376	4	586
422P-16	7311518248383	4	586
422P-20	7311518248390	4	586
422P-25	7311518248406	4	586
422P-6	7311518248352	4	586
4231	7314150100033	3	235
4239	7314150100088	3	235
424P-10	7311518238315	4	584
424P-12	7311518238322	4	584
424P-14	7311518238339	4	584
424P-15	7311518238346	4	584
424P-16	7311518238353	4	584
424P-18	7311518238360	4	584
424P-20	7311518238377	4	584
424P-22	7311518238384	4	584
424P-24	7311518238391	4	584
424P-25	7311518238407	4	584
424P-26	7311518238414	4	584
424P-28	7311518238421	4	584
424P-30	7311518238438	4	584
424P-32	7311518238445	4	584
424P-35	7311518238452	4	584
424P-38	7311518238469	4	584
424P-4	7311518238285	4	584
424P-40	7311518238476	4	584
424P-6	7311518238292	4	584
424P-8	7311518238308	4	584
424P-S3-EUR	7311518249199	1	584
424P-S6-EUR	7311518269968	1	585
424P-S6-GER	7311518280086	1	585
424P-S6-LR	7314150423804	1	584
424P-S6-PP	7314150326662	1	585
424P-S8-EUR	7311518276393	1	585
425-081	7311518010669	1	586
425-082	7311518010676	1	586





425-083	7311518010683	1	586
425-10	7311518004613	4	586
425-12	7311518004620	4	586
425-14	7311518004637	4	586
425-15	7311518017767	4	586
425-16	7311518004644	4	586
425-18	7311518004651	4	586
425-20	7311518004668	4	586
425-22	7311518004675	4	586
425-24	7311518005993	4	586
425-25	7311518004682	4	586
425-26	7311518006006	4	586
425-28	7311518004699	4	586
425-30	7311518004705	4	586
425-32	7311518004712	4	586
425-35	7311518017774	4	586
425-38	7311518004729	4	586
425-4	7311518030810	4	586
425-40	7311518017781	4	586
425-6	7311518004590	4	586
425-8	7311518004606	4	586
426-1000	7311518004309	1	553
426-1200	7311518004316	1	553
426-400	7311518004255	1	553
426-600	7311518004279	1	553
426-800	7311518004293	1	553
426TOR9	7314150125319	10	555
427-13	7314150403578	4	606
427-16	7311518025410	4	606
427-20	7311518025427	4	606
427-24	7314150402878	4	606
427-700	7314150338092	6	606
427-8	7314150402854	4	606
427S-16	7314150404247	4	606
427S-20	7314150404261	4	606
428-16	7311518012380	4	606
428-700	7314150338108	6	607
428F-13	7314150436392	4	606
428F-16	7314150436408	4	606
428F-20	7314150436422	4	606
428F-24	7314150436439	4	606
428F-8	7314150436378	4	606
428S-16	7314150424030	4	606
428S-20	7314150424047	4	606
429-13	7311518012250	4	606
429-16	7311518012403	4	606
429-20	7311518012410	4	606
429-8	7311518040703	4	606
42RM/S12	7314150384785	1	46
4307	7314151079444	1	60
4310	7314151079451	1	60
434-10	7311518238506	4	584
434-12	7311518238513	4	584
434-14	7311518238520	4	584
434-15	7311518238537	4	584
434-16	7311518238544	4	584
434-18	7311518238551	4	584
434-20	7311518238568	4	584
434-22	7311518238575	4	584
434-25	7311518238582	4	584
434-28	7311518238599	4	584
434-30	7311518238605	4	584
434-32	7311518238612	4	584
434-35	7311518238629	4	584
434-38	7311518238636	4	584
434-50	7311518285388	4	584
434-6	7311518238483	4	584
434-8	7311518238490	4	584
434-S3-EUR	7311518249212	1	584
434-S6-EUR	7311518267544	1	584
434-S6-LR	7314150423811	1	584
434-S6-PP	7314150326655	1	584
434-S8-EUR	7311518295110	1	584
439000000	8413345129282	1	481
439000001	7314150268788	1	481
439000002	7314150309702	1	481
439000003	7314150309719	1	481
439000004	7314150427666	1	481
4400-11	7311518200596	10	650
4400-11-BULK	7311518200633	10	650
4400-14	7311518200602	10	650
4400-14-BULK	7311518200640	10	650
440102500	8413345098977	10	609
440103000	8413345098991	10	609
4411-1.00	7314150372744	1	151
4411-1.50	7314150372768	1	151
4411-10.00	7314150372973	1	151
4411-10.20	7314150372980	1	151
4411-10.50	7314150470488	1	151
4411-11.00	7314150372997	1	151
4411-11.50	7314150470495	1	151
4411-12.00	7314150373000	1	151
4411-12.50	7314150470501	1	151
4411-13.00	7314150373017	1	151
4411-2.00	7314150372775	1	151
4411-2.50	7314150372782	1	151



4411-3.00	7314150372799	1	151
4411-3.25	7314150372805	1	151
4411-3.30	7314150372812	1	151
4411-3.50	7314150372829	1	151
4411-4.00	7314150372836	1	151
4411-4.20	7314150372843	1	151
4411-4.25	7314150372850	1	151
4411-4.50	7314150372867	1	151
4411-5.00	7314150372874	1	151
4411-5.50	7314150372881	1	151
4411-6.00	7314150372898	1	151
4411-6.50	7314150372904	1	151
4411-6.80	7314150372911	1	151
4411-7.00	7314150372928	1	151
4411-7.50	7314150372935	1	151
4411-8.00	7314150372942	1	151
4411-8.50	7314150372959	1	151
4411-9.00	7314150372966	1	151
4411-9.50	7314150394463	1	151
4413-1.00	7314150371754	1	152
4413-1.50	7314150371761	1	152
4413-10.00	7314150372034	1	152
4413-10.20	7314150372041	1	152
4413-10.50	7314150470556	25	152
4413-11.00	7314150372058	1	152
4413-11.50	7314150470563	25	152
4413-12.00	7314150372065	1	152
4413-12.50	7314150470570	25	152
4413-13.00	7314150372072	1	152
4413-2.00	7314150371785	1	152
4413-2.50	7314150371792	1	152
4413-3.00	7314150371815	1	152
4413-3.25	7314150371822	1	152
4413-3.30	7314150371877	1	152
4413-3.50	7314150371884	1	152
4413-4.00	7314150371891	1	152
4413-4.20	7314150371907	1	152
4413-4.25	7314150371914	1	152
4413-4.50	7314150371921	1	152
4413-5.00	7314150371938	1	152
4413-5.50	7314150371945	1	152
4413-6.00	7314150371952	1	152
4413-6.50	7314150371969	1	152
4413-6.80	7314150371976	1	152
4413-7.00	7314150371983	1	152
4413-7.50	7314150371990	1	152
4413-8.00	7314150372003	1	152
4413-8.50	7314150372010	1	152
4413-9.00	7314150372027	1	152
4413-9.50	7314150394456	1	152
4415-1.00	7314150394210	1	153
4415-1.50	7314150394227	1	153
4415-10.00	7314150394401	1	153
4415-10.50	7314150470525	1	153
4415-11.00	7314150394418	1	153
4415-11.50	7314150470532	1	153
4415-12.00	7314150394425	1	153
4415-12.50	7314150470549	1	153
4415-13.00	7314150394432	1	153
4415-13.50	7314150441495	1	153
4415-14.00	7314150441501	1	153
4415-14.50	7314150441518	1	153
4415-15.00	7314150441525	1	153
4415-15.50	7314150441532	1	153
4415-16.00	7314150441549	1	153
4415-16.50	7314150441556	1	153
4415-17.00	7314150441563	1	153
4415-17.50	7314150441570	1	153
4415-18.00	7314150441587	1	153
4415-18.50	7314150441594	1	153
4415-19.00	7314150441600	1	153
4415-19.50	7314150441617	1	153
4415-2.00	7314150394234	1	153
4415-2.50	7314150394241	1	153
4415-20.00	7314150441624	1	153
4415-3.00	7314150394258	1	153
4415-3.25	7314150394265	1	153
4415-3.50	7314150394272	1	153
4415-4.00	7314150394289	1	153
4415-4.25	7314150394296	1	153
4415-4.50	7314150394302	1	153
4415-5.00	7314150394319	1	153
4415-5.50	7314150394326	1	153
4415-6.00	7314150394333	1	153
4415-6.50	7314150394340	1	153
4415-7.00	7314150394357	1	153
4415-7.50	7314150394364	1	153
4415-8.00	7314150394371	1	153
4415-8.50	7314150394388	1	153
4415-9.00	7314150394395	1	153
442	7311518002848	10	562
442 B	7314150008957	1	266
442-3P	7314150309610	10	562
4420-11	7311518200619	10	650
4420-11-BULK	7311518200657	10	650
4420-14	7311518200626	10	650



4420-14-BULK	7311518200664	10	650
443 B	7314150008971	1	266
4430	7314150100040	3	245
4435-12.4	7314150465163	1	154
444 B	7314150009008	1	266
4480/2-ZD	7311518276911	1	271
4480IM	7314150263165	1	271
4480MM	7314150263158	1	271
449	7311518005337	10	562
44Z-1/2-9/16	7314150375233	10	53
44Z-1/4-5/16	7314150375196	10	53
44Z-11/16-13/16	7314150375264	5	53
44Z-11/16-3/4	7314150375257	5	53
44Z-3/8-7/16	7314150375219	10	53
44Z-5/16-3/8	7314150375202	10	53
44Z-5/8-3/4	7314150375240	5	53
44Z-7/16-1/2	7314150375226	10	53
451	7311518014506	10	562
4511-0.50-10P	7314150373079	1	151
4511-0.75-10P	7314150373062	1	151
4511-1.00-10P	7314150373055	1	151
4511-1.50-10P	7314150373086	1	151
4511-1.75-10P	7314150373093	1	151
4511-10.00-5P	7314150373444	1	151
4511-10.20-5P	7314150373468	1	151
4511-10.30-5P	7314150373475	1	151
4511-10.50-5P	7314150373482	1	151
4511-10.80-5P	7314150373499	1	151
4511-11.00-5P	7314150373505	1	151
4511-11.50-5P	7314150373512	1	151
4511-12.00-5P	7314150373529	1	151
4511-12.50-5P	7314150373536	1	151
4511-12.80-5P	7314150373543	1	151
4511-13.00-5P	7314150373550	1	151
4511-13.50-1P	7314150373567	1	151
4511-14.00-1P	7314150373574	1	151
4511-14.50-1P	7314150373581	1	151
4511-15.00-1P	7314150373598	1	151
4511-15.50-1P	7314150373604	1	151
4511-16.00-1P	7314150373611	1	151
4511-16.50-1P	7314150373628	1	151
4511-17.00-1P	7314150373635	1	151
4511-17.50-1P	7314150373642	1	151
4511-18.00-1P	7314150373659	1	151
4511-18.50-1P	7314150373673	1	151
4511-19.00-1P	7314150373680	1	151
4511-19.50-1P	7314150373697	1	151
4511-2.00-10P	7314150373109	1	151
4511-2.50-10P	7314150373116	1	151
4511-2.70-10P	7314150373123	1	151
4511-2.90-10P	7314150373130	1	151
4511-20.00-1P	7314150373666	1	151
4511-3.00-10P	7314150373147	1	151
4511-3.10-10P	7314150373185	1	151
4511-3.25-10P	7314150373192	1	151
4511-3.30-10P	7314150373208	1	151
4511-3.50-10P	7314150373215	1	151
4511-3.80-10P	7314150373222	1	151
4511-4.00-10P	7314150373239	1	151
4511-4.20-10P	7314150373246	1	151
4511-4.50-10P	7314150373253	1	151
4511-4.80-10P	7314150373260	1	151
4511-5.00-10P	7314150373277	1	151
4511-5.20-10P	7314150373284	1	151
4511-5.50-10P	7314150373291	1	151
4511-6.00-10P	7314150373307	1	151
4511-6.20-10P	7314150373314	1	151
4511-6.50-10P	7314150373321	1	151
4511-6.80-10P	7314150373338	1	151
4511-7.00-10P	7314150373345	1	151
4511-7.20-10P	7314150373352	1	151
4511-7.50-10P	7314150373369	1	151
4511-7.80-10P	7314150373376	1	151
4511-8.00-10P	7314150373383	1	151
4511-8.50-10P	7314150373390	1	151
4511-8.60-10P	7314150373406	1	151
4511-8.80-10P	7314150373413	1	151
4511-9.00-10P	7314150373420	1	151
4511-9.20-10P	7314150373437	1	151
4511-9.50-10P	7311518339081	1	151
4511-9.60-10P	7314150373451	1	151
4511-SET-19	7314150373031	1	151
4511-SET-25	7314150373048	1	152
4511-SET-6	7314150373024	1	151
4513-1.00-10P	7314150372119	1	152
4513-1.50-10P	7314150372126	1	152
4513-1.75-10P	7314150372133	1	152
4513-10.00-5P	7314150391998	1	152
4513-10.20-5P	7314150392001	1	152
4513-10.30-5P	7314150392018	1	152
4513-10.50-5P	7314150392025	1	152
4513-10.80-5P	7314150392032	1	152
4513-11.00-5P	7314150392049	1	152
4513-11.50-5P	7314150392056	1	152
4513-12.00-5P	7314150392063	1	152
4513-12.50-5P	7314150392070	1	152



4513-12.80-5P	7314150392087	1	152
4513-13.00-5P	7314150392094	1	152
4513-13.50-1P	7314150392100	1	152
4513-14.00-1P	7314150392117	1	152
4513-14.50-1P	7314150392124	1	152
4513-15.00-1P	7314150392131	1	152
4513-15.50-1P	7314150392148	1	152
4513-16.00-1P	7314150392155	1	152
4513-16.50-1P	7314150392162	1	152
4513-17.00-1P	7314150392179	1	152
4513-17.50-1P	7314150392186	1	152
4513-18.00-1P	7314150392193	1	152
4513-18.50-1P	7314150392209	1	152
4513-19.00-1P	7314150392216	1	152
4513-19.50-1P	7314150392223	1	152
4513-2.00-10P	7314150372140	1	152
4513-2.50-10P	7314150372157	1	152
4513-2.70-10P	7314150372164	1	152
4513-2.90-10P	7314150372171	1	152
4513-20.00-1P	7314150392230	1	152
4513-3.00-10P	7314150372188	1	152
4513-3.10-10P	7314150372195	1	152
4513-3.25-10P	7314150372201	1	152
4513-3.30-10P	7314150372218	1	152
4513-3.50-10P	7314150372225	1	152
4513-3.80-10P	7314150372232	1	152
4513-4.00-10P	7314150372249	1	152
4513-4.20-10P	7314150372256	1	152
4513-4.50-10P	7314150372263	1	152
4513-4.80-10P	7314150372270	1	152
4513-5.00-10P	7314150372287	1	152
4513-5.20-10P	7314150372294	1	152
4513-5.50-10P	7314150372300	1	152
4513-6.00-10P	7314150372317	1	152
4513-6.20-10P	7314150372324	1	152
4513-6.50-10P	7314150372331	1	152
4513-6.80-10P	7314150372348	1	152
4513-7.00-10P	7314150372355	1	152
4513-7.20-10P	7314150372362	1	152
4513-7.50-10P	7314150372379	1	152
4513-7.80-10P	7314150372386	1	152
4513-8.00-10P	7314150372393	1	152
4513-8.50-10P	7314150372409	1	152
4513-8.60-10P	7314150372416	1	152
4513-8.80-10P	7314150372423	1	152
4513-9.00-10P	7314150372430	1	152
4513-9.20-10P	7314150372447	1	152
4513-9.50-10P	7314150372454	1	152
4513-9.60-10P	7314150372461	1	152
4513-SET-19	7314150372096	1	152
4513-SET-25	7314150372102	1	153
4513-SET-6	7314150372089	1	152
4515-1.00-10P	7314150441228	1	153
4515-1.50-10P	7314150441235	1	153
4515-10.00-10P	7314150441426	1	153
4515-10.50-5P	7314150441433	1	153
4515-11.00-5P	7314150441440	1	153
4515-11.50-5P	7314150441457	1	153
4515-12.00-5P	7314150441464	1	153
4515-12.50-5P	7314150441471	1	153
4515-13.00-5P	7314150441488	1	153
4515-2.00-10P	7314150441242	1	153
4515-2.50-10P	7314150441259	1	153
4515-3.00-10P	7314150441266	1	153
4515-3.25-10P	7314150441273	1	153
4515-3.50-10P	7314150441280	1	153
4515-4.00-10P	7314150441297	1	153
4515-4.25-10P	7314150441303	1	153
4515-4.50-10P	7314150441310	1	153
4515-5.00-10P	7314150441327	1	153
4515-5.50-10P	7314150441334	1	153
4515-6.00-10P	7314150441341	1	153
4515-6.50-10P	7314150441358	1	153
4515-7.00-10P	7314150441365	1	153
4515-7.50-10P	7314150441372	1	153
4515-8.00-10P	7314150441389	1	153
4515-8.50-10P	7314150441396	1	153
4515-9.00-10P	7314150441402	1	153
4515-9.50-10P	7314150441419	1	153
4515-SET-19	7314150394449	1	153
4515-SET-25	7314150441709	1	153
4518-3	7314151716547	1	369
4518-4	7314151716622	1	369
4518-5	7314151716899	1	369
4519-1	7314151716974	1	367
4519-1/B	7314150225149	1	367
4519-1/S	7314151843762	1	367
4519-2	7314151717193	1	367
4519-2/S	7314151843977	1	367
4519-23/B	7314150225156	1	367
4519-3	7314151717278	1	367
4519K1	7314150225163	1	367
4519K2	7314150225170	1	367
4519K3	7314150225187	1	367
4521N-0	7314151837723	1	369
4521N-00	7314151837716	1	369



4521N-A



4521N-A	7314151837730	1	369
4521N-B	7314151837747	1	369
4521N-C	7314151837754	1	369
4521N-D	7314151837761	1	369
4521N-E	7314151837778	1	369
4521N-F	7314151837785	1	369
4521N-G	7314151837792	1	369
4521N-H	7314151837808	1	369
4521N-I	7314151837815	1	369
4521N-K	7314151837822	1	369
4521N-L	7314151837839	1	369
4521N-M	7314151837846	1	369
4521N-S	7314151839789	1	369
4521N-T	7314151839796	1	369
4521N/7	7314151839802	1	369
4522-1	7314151081591	1	369
4522-1/B	7314150225033	1	369
4522-1/S	7314150225064	1	369
4522-2	7314151081614	1	369
4522-2/B	7314150225057	1	369
4522-2/S	7314150225071	1	369
4522K1	7314150225088	1	369
4522K2	7314150225095	1	369
4523G	7314151846695	1	369
4524G	7314151718596	1	369
4528-1	7314151718671	1	366
4528-1/B	7314150224692	1	366
4528K1	7314151837662	1	366
4528K2	7314151837679	1	366
4528K3	7314151837686	1	366
4528K4	7314151837693	1	366
4528K5	7314151837709	1	366
4528M1	7314151718916	1	367
4528M1/B	7314150224654	1	367
4528M1/P	7314150330959	1	367
4528M2	7314151719050	1	367
4528M2/B	7314150224661	1	367
4528M2/P	7314150330980	1	367
4528M3	7314151719135	1	367
4528M3/P	7314150330973	1	367
4528M345/B	7314150224678	1	367
4528M4	7314151719210	1	367
4528M5	7314151719487	1	367
4528MK5	7314150224685	1	367
4529-15	7314151719647	1	366
4529-8	7314151719562	1	366
4530	7314150100095	3	246
4532-0	7314151719722	1	366
4532-A	7314151082109	1	366
4532-AL	7314150221912	1	366
4532-B	7314151082116	1	366
4532-BL	7314150221929	1	366
4532-C	7314151082123	1	366
4532-CD/S	7314151818067	1	366
4532-CL	7314150221936	1	366
4532-D	7314151082130	1	366
4532-E	7314151082147	1	366
4532-EFG/S	7314151838386	1	366
4532-F	7314151082154	1	366
4532-G	7314151082161	1	366
4532-G-SO	7314151841003	1	366
4532-H	7314151719999	1	366
4532-H/S	7314151838393	1	366
4532-OAB/S	7314151818050	1	366
4532K1	7314151082185	1	366
4532K2	7314151082192	1	366
4532K3	7314151082208	1	366
4532K4	7314151720148	1	366
4532LK1	7314151082215	1	366
4532LK2	7314151082222	1	366
4532LK3	7314151082239	1	366
4532LK4	7314151082246	1	366
4532LK5	7314151720223	1	366
4532ST/5	7314151720490	1	366
4533HP	7314151793043	1	366
4533HP/S	7314150224487	1	366
4533HPK	7314150224500	1	366
4533M	7314151793050	1	366
4533M/S	7314150224494	1	366
4533MK	7314150224517	1	366
4537-1	7314151720650	1	367
4537-1/B	7314150224562	1	367
4537-2	7314151720735	1	367
4537-2/B	7314150224579	1	367
4537-3	7314151720810	1	367
4537-34/B	7314150224586	1	367
4537-4	7314151721039	1	367
4537K1	7314150224593	1	367
4537K2	7314150224609	1	367
4537K3	7314150224616	1	367
4537K4	7314150224623	1	367
4540-17	7314150125005	1	368
4540-17/S	7314150225248	1	368
4540-25	7314150125012	1	368
4540-25/S	7314150225286	1	368
4541-A	7314151082413	1	367



4541-A/B	7314150224524	1	367
4541-B	7314151082420	1	367
4541-B/B	7314150224531	1	367
4541KA	7314150224548	1	367
4541KB	7314150224555	1	367
4542-A	7314151082451	1	367
4542-A/B	7314150224630	1	367
4542-B	7314151082468	1	367
4542-B/B	7314150224647	1	367
4543-1	7314151082499	1	367
4543-1/S	7314151818623	1	367
4543-10	7314151721466	1	367
4543-1020/B	7314150224715	1	367
4543-12/B	7314150224708	1	367
4543-2	7314151082505	1	367
4543-2/S	7314151818661	1	367
4543-20	7314151721541	1	367
4543-3	7314151721381	1	367
4543-3/B	7314150224739	1	367
4543-3/S	7314151818708	1	367
4543-30	7314151721626	1	367
4543-30/B	7314150224722	1	367
4543K110	7314150224746	1	367
4543K220	7314150224753	1	367
4543K330	7314150224760	1	367
4544-1	7314151844004	1	366
4544-1/B	7314150224845	1	367
4544-10	7314151844042	1	367
4544-10/B	7314150224883	1	367
4544-110/S	7314150224777	1	367
4544-2	7314151844011	1	366
4544-2/B	7314150224852	1	367
4544-20	7314151844059	1	367
4544-20/B	7314150224890	1	367
4544-220/S	7314150224784	1	367
4544-3	7314151844028	1	367
4544-3/B	7314150224869	1	367
4544-30	7314151844066	1	367
4544-30/B	7314150224906	1	367
4544-4	7314151844035	1	367
4544-4/B	7314150224876	1	367
4544-440/S	7314150224791	1	367
4544K110	7314150224807	1	367
4544K220	7314150224814	1	367
4544K330	7314150224821	1	367
4544K440	7314150224838	1	367
4545-1	7314151082543	1	370
4545-2	7314151082550	1	370
4545-3	7314151082567	1	370
4545-4	7314151722272	1	370
4545-5	7314151722357	1	370
4545-N1	7314151722432	1	369
4545-N1/S	7314150224913	1	369
4545-N11	7314150249169	1	369
4545-N2	7314151804947	1	369
4545-N2/S	7314150224920	1	369
4545-N21	7314150249176	1	369
4551-A	7314151082628	1	368
4551-A/S	7314150224937	1	368
4551-B	7314151722784	1	368
4551-B/S	7314150224944	1	368
4551-C	7314151082642	1	368
4551-C/S	7314150224951	1	368
4551-D	7314151082659	1	368
4551-D/S	7314150224968	1	368
4552-1	7314151722944	1	368
4552-1/B	7314150224975	1	368
4552-2	7314151723088	1	368
4552-2/B	7314150224982	1	368
4552-3	7314151723163	1	368
4552-3/B	7314150224999	1	368
4552K1	7314150225002	1	368
4552K2	7314150225019	1	368
4552K3	7314150225026	1	368
4553	7314151830649	1	371
4559-12	7314150113132	1	239
4559-12A JC	7314150223909	1	239
4559-18	7314150024513	8	239
4559-18B JC	7314150113880	1	239
4559-24	7314150024520	6	239
4559-24B JC	7314150113897	1	239
4559-30	7314150024537	5	239
4559-30B JC	7314150113903	1	239
4559-36	7314150024544	3	239
4559-36B JC	7314150113910	1	239
4559-42	7314150024551	2	239
4559-42A JC	7314150208876	1	239
4560-210	7314150178995	1	239
4574	7314151799014	1	368
4577	7314151838348	1	370
4578	7314150222308	1	369
4579	7314150222018	1	370
4580N/7	7314151301361	1	368
4581N-1	7314151724139	1	368
4581NA	7314151301200	1	368
4581NB	7314151301217	1	368



4581NB2	7314151724726	1	368
4581NC	7314151301224	1	368
4582N-1	7314151724214	1	368
4582N-2	7314151724481	1	368
4582NA	7314151301248	1	368
4582NB	7314151301255	1	368
4583N-1	7314151724566	1	368
4583N-2	7314151724641	1	368
4583NA	7314151301279	1	368
4583NB	7314151301286	1	368
4590SHS5	7314150384822	4	370
4591	7314151804039	1	371
4592	7314151804046	1	371
4593	7314151804053	1	371
4594VWT4	7314150403639	5	335
45S/H1.5	7314150218530	1	165
45S/H1.5-2P	7314150261505	50	165
45S/H2	7314150218547	1	165
45S/H2-2P	7314150261512	50	165
45S/H2.5	7314150218554	1	165
45S/H2.5-2P	7314150261529	50	165
45S/H3	7314150218561	1	165
45S/H3-2P	7314150261536	50	165
45S/PH1	7314150218516	1	165
45S/PH1-2P	7314150261482	50	165
45S/PH2	7314150218523	1	165
45S/PH2-2P	7314150261499	50	165
4610-1	7314151724993	1	370
4611-2	7314151725372	1	370
4611-2/B	7314150237500	1	370
4611-2/S	7314150237494	1	370
4611-3	7314150125043	1	370
4611-3/B	7314150237524	1	370
4611-3/S	7314150237517	1	370
4614-1	7314151725457	1	368
4614-1/B	7314150225101	1	368
4614-2	7314151725532	1	368
4614-2/B	7314150225118	1	368
4614K1	7314150225125	1	368
4614K2	7314150225132	1	368
4626-10.0	7314150457670	1	156
4626-4.0	7314150457632	1	156
4626-5.0	7314150457649	1	156
4626-6.0	7314150457656	1	156
4626-8.0	7314150457663	1	156
4629-10.0	7314150465385	1	156
4629-4.0	7314150465347	1	156
4629-5.0	7314150465354	1	156
4629-6.0	7314150465361	1	156
4629-8.0	7314150465378	1	156
4629-SET-5	7314150467204	10	156
4630	73141502216154	1	624
4641-10-120	7314150383085	1	150
4641-10-200	7314150383115	1	150
4641-10-400	7314150383207	1	150
4641-10-600	7314150383221	1	150
4641-11-150	7314150383122	1	150
4641-12-150	7314150383139	1	150
4641-12-200	7314150383146	1	150
4641-12-400	7314150383238	1	150
4641-12-600	7314150383245	1	150
4641-13-150	7314150383153	1	150
4641-14-150	7314150383160	1	150
4641-14-400	7314150383252	1	150
4641-14-600	7314150383269	1	150
4641-16-150	7314150383177	1	150
4641-16-400	7314150383276	1	150
4641-16-600	7314150383283	1	150
4641-18-400	7314150383290	1	150
4641-18-600	7314150383306	1	150
4641-20-400	7314150383313	1	150
4641-20-600	7314150383320	1	150
4641-22-400	7314150383337	1	150
4641-24-400	7314150383344	1	150
4641-25-400	7314150383351	1	150
4641-3-60	7314150382859	1	150
4641-4-75	7314150382866	1	150
4641-5-150	7314150382880	1	150
4641-5-85	7314150382873	1	150
4641-5.5-85	7314150382897	1	150
4641-6-100	7314150383016	1	150
4641-6-150	7314150383023	1	150
4641-6-400	7314150383184	1	150
4641-6.5-100	7314150383030	1	150
4641-7-100	7314150383047	1	150
4641-8-120	7314150383054	1	150
4641-8-200	7314150383061	1	150
4641-8-400	7314150383191	1	150
4641-9-120	7314150383078	1	150
4641-PB	7314150383368	1	150
4643-PB	7314150441679	1	150
4651-10-1000	7314150386413	1	149
4651-10-110	7314150386345	1	149
4651-10-160	7314150386352	1	149
4651-10-160-10P	7314150475483	1	149
4651-10-210	7314150386369	1	149



4651-10-210-10P	7314150475513	1	149
4651-10-260	7314150386376	1	149
4651-10-310	7314150386383	1	149
4651-10-450	7314150386390	1	149
4651-10-600	7314150386406	1	149
4651-12-1000	7314150386581	1	149
4651-12-160	7314150386529	1	149
4651-12-160-10P	7314150475490	1	149
4651-12-210	7314150386536	1	149
4651-12-210-10P	7314150475520	1	149
4651-12-260	7314150386543	1	149
4651-12-310	7314150386550	1	149
4651-12-450	7314150386567	1	149
4651-12-600	7314150386574	1	149
4651-14-1000	7314150386659	1	149
4651-14-160	7314150386598	1	149
4651-14-210	7314150386604	1	149
4651-14-260	7314150386611	1	149
4651-14-310	7314150386628	1	149
4651-14-450	7314150386635	1	149
4651-14-600	7314150386642	1	149
4651-15-160	7314150386666	1	149
4651-15-260	7314150386673	1	149
4651-15-450	7314150386680	1	149
4651-16-1000	7314150386765	1	149
4651-16-160	7314150386697	1	149
4651-16-210	7314150386710	1	149
4651-16-260	7314150386727	1	149
4651-16-310	7314150386734	1	149
4651-16-450	7314150386741	1	149
4651-16-600	7314150386758	1	149
4651-18-250	7314150386789	1	149
4651-18-450	7314150386796	1	149
4651-20-250	7314150386802	1	149
4651-20-450	7314150386819	1	149
4651-22-250	7314150386826	1	149
4651-22-450	7314150386833	1	149
4651-24-250	7314150386840	1	149
4651-24-450	7314150386857	1	149
4651-25-250	7314150386864	1	149
4651-25-450	7314150386871	1	149
4651-28-250	7314150386888	1	149
4651-28-450	7314150386895	1	149
4651-30-250	7314150386901	1	149
4651-30-450	7314150386918	1	149
4651-32-450	7314150386925	1	149
4651-5-110	7314150385683	1	149
4651-5-110-10P	7314150475407	1	149
4651-5-160	7314150385690	1	149
4651-5-160-10P	7314150475438	1	149
4651-5-260	7314150385713	1	149
4651-5-5-110	7314150385720	1	149
4651-5-5-110-10P	7314150475414	10	149
4651-5-5-160	7314150385737	1	149
4651-5-5-160-10P	7314150475445	1	149
4651-6-110	7314150385744	1	149
4651-6-110-10P	7314150475421	1	149
4651-6-160	7314150385751	1	149
4651-6-160-10P	7314150475452	1	149
4651-6-210	7314150385768	1	149
4651-6-260	7314150385775	1	149
4651-6-310	7314150385782	1	149
4651-6-5-110	7314150475391	50	149
4651-6-5-160	7314150385799	1	149
4651-6-5-160-10P	7314150475469	1	149
4651-6-5-210	7314150385805	1	149
4651-6-5-260	7314150385812	1	149
4651-6-5-310	7314150385829	1	149
4651-7-110	7314150385836	1	149
4651-7-160	7314150386253	1	149
4651-8-110	7314150386277	1	149
4651-8-160	7314150386284	1	149
4651-8-160-10P	7314150475476	1	149
4651-8-210	7314150386291	1	149
4651-8-210-10P	7314150475506	1	149
4651-8-260	7314150386307	1	149
4651-8-310	7314150386314	1	149
4651-8-460	7314150386321	1	149
4651-SET-5	7314150475537	1	149
4651-SET-7	7314150475544	1	149
4652-10-110	7314150385119	1	149
4652-10-160	7314150385126	1	149
4652-10-160-10P	7314150475322	1	149
4652-10-210	7314150385133	1	149
4652-10-210-10P	7314150475353	1	149
4652-10-260	7314150385140	1	149
4652-10-310	7314150385164	1	149
4652-10-450	7314150385171	1	149
4652-10-600	7314150385188	1	149
4652-11-160	7314150385195	1	149
4652-11-260	7314150385218	1	149
4652-12-1000	7314150385287	1	149
4652-12-160	7314150385225	1	149
4652-12-160-10P	7314150475339	1	149
4652-12-210	7314150385232	1	149
4652-12-210-10P	7314150475360	1	149





4652-12-260	7314150385249	1	149
4652-12-310	7314150385256	1	149
4652-12-450	7314150385263	1	149
4652-12-600	7314150385270	1	149
4652-13-310	7314150385300	1	150
4652-14-1000	7314150385379	1	150
4652-14-160	7314150385317	1	150
4652-14-210	7314150385324	1	150
4652-14-260	7314150385331	1	150
4652-14-310	7314150385348	1	150
4652-14-450	7314150385355	1	150
4652-14-600	7314150385362	1	150
4652-15-260	7314150385393	1	150
4652-16-1000	7314150385478	1	150
4652-16-210	7314150385416	1	150
4652-16-260	7314150385423	1	150
4652-16-310	7314150385430	1	150
4652-16-450	7314150385447	1	150
4652-16-600	7314150385454	1	150
4652-18-1000	7314150385515	1	150
4652-18-200	7314150385485	1	150
4652-18-300	7314150385492	1	150
4652-18-450	7314150385508	1	150
4652-20-1000	7314150385560	1	150
4652-20-200	7314150385522	1	150
4652-20-300	7314150385539	1	150
4652-20-450	7314150385546	1	150
4652-20-600	7314150385553	1	150
4652-22-1000	7314150385607	1	150
4652-22-250	7314150385577	1	150
4652-22-450	7314150385584	1	150
4652-22-600	7314150385591	1	150
4652-24-250	7314150385614	1	150
4652-24-450	7314150385621	1	150
4652-25-1000	7314150385652	1	150
4652-25-250	7314150385638	1	150
4652-25-450	7314150385645	1	150
4652-26-250	7314150385669	1	150
4652-26-450	7314150385676	1	150
4652-3-110	7314150475216	50	149
4652-3.5-110	7314150475223	50	149
4652-4-110	7314150384365	1	149
4652-4-160	7314150384372	1	149
4652-5-110	7314150384815	1	149
4652-5-110-10P	7314150475247	1	149
4652-5-160	7314150384839	1	149
4652-5-160-10P	7314150475278	1	149
4652-5-210	7314150384846	1	149
4652-5.5-110	7314150384853	1	149
4652-5.5-110-10P	7314150475254	10	149
4652-5.5-160	7314150384860	1	149
4652-5.5-160-10P	7314150475285	1	149
4652-5.5-210	7314150475230	50	149
4652-6-110	7314150384877	1	149
4652-6-110-10P	7314150475261	1	149
4652-6-160	7314150384891	50	149
4652-6-160-10P	7314150475292	1	149
4652-6-210	7314150384907	1	149
4652-6-260	7314150384969	1	149
4652-6.5-110	7314150384976	1	149
4652-6.5-160	7314150384990	1	149
4652-6.5-160-10P	7314150475308	1	149
4652-7-110	7314150385003	1	149
4652-7-160	7314150391981	1	149
4652-8-110	7314150385034	1	149
4652-8-160	7314150385058	1	149
4652-8-160-10P	7314150475315	1	149
4652-8-210	7314150385065	1	149
4652-8-210-10P	7314150475346	1	149
4652-8-260	7314150385072	1	149
4652-8-460	7314150385089	1	149
4652-9-160	7314150385096	1	149
4652-9-210	7314150385102	1	149
4652-SET-5	7314150475377	1	150
4652-SET-7	7314150475384	1	150
4655-FLAT-250	7314150387823	1	151
4655-HOLLOW-240	7314150387847	1	151
4655-POINT-250	7314150387816	1	151
4655-SLOT-25032	7314150387885	1	151
4655-TILE-20040	7314150387861	1	151
4655-WIDE-20040	7314150387830	1	151
4655-WING-C-250	7314150387854	1	151
4656-12-340	7314150386932	1	148
4656-12-540	7314150387021	1	148
4656-14-340	7314150387069	1	148
4656-14-540	7314150387076	1	148
4656-15-340	7314150387083	1	148
4656-16-1320	7314150387137	1	148
4656-16-340	7314150387106	1	148
4656-16-540	7314150387113	1	148
4656-16-940	7314150387120	1	148
4656-18-1320	7314150387175	1	148
4656-18-340	7314150387144	1	148
4656-18-540	7314150387151	1	148
4656-18-940	7314150387168	1	148
4656-20-1320	7314150387212	1	148



4656-20-320	7314150387182	1	148
4656-20-520	7314150387199	1	148
4656-20-920	7314150387205	1	148
4656-22-1320	7314150387250	1	148
4656-22-320	7314150387229	1	148
4656-22-520	7314150387236	1	148
4656-22-920	7314150387243	1	148
4656-24-320	7314150387267	1	148
4656-24-520	7314150387274	1	148
4656-25-1320	7314150387311	1	148
4656-25-320	7314150387281	1	148
4656-25-520	7314150387298	1	148
4656-25-920	7314150387304	1	148
4656-26-520	7314150387328	1	148
4656-28-370	7314150387434	1	148
4656-28-570	7314150387458	1	148
4656-28-670	7314150387489	1	148
4656-28-920	7314150387526	1	148
4656-30-370	7314150387540	1	148
4656-30-570	7314150387571	1	148
4656-32-1320	7314150387649	1	148
4656-32-370	7314150387595	1	148
4656-32-570	7314150387618	1	148
4656-32-920	7314150387632	1	148
4656-35-370	7314150387656	1	148
4656-35-570	7314150387663	1	148
4656-35-670	7314150387670	1	148
4656-37-370	7314150387687	1	148
4656-37-570	7314150387694	1	148
4656-37-920	7314150387700	1	148
4656-38-370	7314150387717	1	148
4656-38-570	7314150387724	1	148
4656-40-1320	7314150387762	1	148
4656-40-370	7314150387731	1	148
4656-40-570	7314150387748	1	148
4656-40-920	7314150387755	1	148
4656-45-570	7314150387779	1	148
4656-45-920	7314150387786	1	148
4656-50-570	7314150387793	1	148
4656-52-570	7314150387809	1	148
4659-FLAT-28	7314150387922	1	151
4659-FLAT-40	7314150387939	1	151
4659-FLAT-60	7314150387946	1	151
4659-POINT-28	7314150387892	1	151
4659-POINT-40	7314150387908	1	151
4659-POINT-60	7314150387915	1	151
4659-TILE-30-5	7314150388042	1	151
4659-TILE-30-8	7314150388059	1	151
4659-WIDE-30-8	7314150387953	1	151
4659-WIDE-36-5	7314150387984	1	151
466-1000	7314150128327	4	553
466-1000-M	7314150186105	4	553
466-1200	7314150128334	4	553
466-1200-M	7314150186129	4	553
466-1800	7314150128341	4	553
466-2000	7314150129836	4	553
466-250	7314150128655	10	555
466-400	7314150128297	4	553
466-400-M	7314150128358	4	553
466-600	7314150128303	4	553
466-600-M	7314150128365	4	553
466-800	7314150128310	4	553
466-800-M	7314150186082	4	553
466-BE1	7314150215218	12	555
466-LINE	7314150215249	12	555
466-POST	7314150215232	6	555
4724-JT	7311518265847	1	650
4728-JT	7311518265854	1	650
474-125-0.60	7311518029050	10	563
474-125-0.80	7311518029869	10	563
474-150-0.60	7311518029876	10	563
474-150-0.80	7311518029883	10	563
4750-2PP-1	7314153014733	1	475
4750-3PB-1	7314153014719	1	475
4750-3PB-2	7314150187782	1	482
4750-BWC-1	7314153018809	1	477
4750-DHO-3	7314150289530	1	476
4750-DHO-4	7314150303908	1	482
4750-EP-1	7314153014726	1	476
4750-FOLTC-1	7314153019271	1	474
4750-HDB-2	7314150289486	1	475
4750-HDBS-2	7314150289479	1	475
4750-HDLB-1	7314153014757	1	475
4750-HDLB-TAH	7314150303892	1	483
4750-HHO-2	7314153014863	1	483
4750-JU3PB-1	7314153015747	1	475
4750-KNHO-0	7314150289462	1	476
4750-KNHO-1	7314153015839	1	476
4750-KP-1	7314153014771	1	476
4750-LV-1	7314150358052	1	473
4750-LV-2	7314150393800	1	473
4750-MPH-1	7314150291625	1	476
4750-MTHO-TAH	7314150319589	1	483
4750-PSTB-1	7314150340491	1	650
4750-QRFB-1	7314150289455	1	475
4750-ROCO-1	7314153015273	1	476



4750-SF-1	7314150326082	1	473
4750-SF-2	7314150326099	1	473
4750-TOCST-1	7314153018779	1	474
4750-UP-1	7314153014795	1	476
4750-UP-2	7314150187768	1	483
4750-VDEC	7314150222377	1	474
4750-VMPH-1	7314153014818	1	476
4750ALC01FF1	7314150508884	1	438
4750BMC10	7314150264032	1	477
4750BMC10FF1	7314150500673	1	451
4750BMC3	7314150359639	1	477
4750BMC4	7314150426256	1	477
4750BMC5	7314150264001	1	477
4750BMC5.5	7314150326167	1	477
4750BMC6	7314150264018	1	477
4750BMC7	7314150277605	1	477
4750BMC9	7314150264025	1	477
4750BMC9.5	7314150326174	1	477
4750FB1-19A	7314150277612	1	472
4750FB1-19B	7314150277629	4	472
4750FB2-19A	7314150277636	4	472
4750FB2-19TS001	7314150302772	1	454
4750FB2-24A	7314150277643	2	472
4750FB2W-24A	7314150277650	1	472
4750FB2W-TS001	7314150302765	1	454
4750FB3-12	7314150277667	1	473
4750FB4-18	7314150277674	4	473
4750FB4-18TS001	7314150302758	1	478
4750FB5-FG1	7314150401796	1	474
4750FB5-FG2	7314150401819	1	474
4750FB5A	7314150277704	1	473
4750FB5ATS001	7314150302727	1	439
4750FB5B	7314150277698	1	474
4750FB5BFF1	7314150302734	1	439
4750FB5C	7314150277681	8	474
4750FB6-13	7314150393091	1	473
4750FB6-19	7314150393114	1	473
4750FB7-01	7314150465668	60	474
4750FB7-02	7314150465675	60	474
4750FB7ORBG	7314150465682	120	475
4750FB7ORLT	7314150465699	120	475
4750FB8	7314150465651	4	472
4750PTB50	7314150275007	3	477
4750PTB60	7314150275014	3	477
4750PTB65	7314150345809	2	477
4750PTB65TS5	7314150456260	1	440
4750PTBW47	7314150275021	1	477
4750PTBW67	7314150289189	1	477
4750RC01	7314150220151	1	458
4750RC02	7314150220168	1	458
4750RC021	7314150226641	1	458
4750RCHD-AC1	7314150229857	1	459
4750RCHD00	7314150271603	1	457
4750RCHD01	7314150227426	1	457
4750RCHD011	7314150229802	1	457
4750RCHD01AC1	7314150229819	1	458
4750RCHD01AC2	7314150229826	1	458
4750RCHD01FF1	7314150247578	1	452
4750RCHDW01	7314150227433	1	457
4750RCHDW01AC1	7314150229833	1	459
4750RCHDW01AC2	7314150229840	1	459
4750RCHDW01FF1	7314150247561	1	451
4750RCHDW01FF2	7314150249183	1	451
4750RCHDW01FF3	7314150249190	1	437
4750RCHDW01FF4	7314150309580	1	453
4750RCHDW01FF9	7314150345533	1	453
4750RCHDW01RED	7314150407538	1	457
4750RCHDW02	7314150227440	1	457
4750RCHDW02FF1	7314150267422	1	453
4750RCHDW02FF15	7314150347698	1	456
4750RCHDW02FF2	7314150306787	1	456
4750RCHDW02FF4	7314150309559	1	455
4750RCHDW02RED	7314150407545	1	457
4750RCHDW02RF1V	7314150422081	1	437
4750RCHDW10	7314150425587	1	457
4750RCW01	7314150220182	1	458
4750RCW011	7314150226627	1	458
4750RCWD-AC1	7314150277179	1	458
4750RCWD-AC2	7314150277186	1	458
4750RCWD-AC3	7314150277193	1	458
4750RCWD-AC4	7314150277209	1	458
4750RCWD4	7314150277124	1	457
4750RCWD4-OR	7314150409501	1	457
4750RCWD4FF1	7314150302413	1	436
479-08	7311518025441	6	607
479-12	7311518025458	6	607
479-16	7311518025465	6	607
479-20	7314150319862	6	607
479-24	7311518025472	6	607
479-32	7311518025489	6	607
479F-08	7314150441952	6	607
479F-12	7314150441976	6	607
479F-16	7314150441983	6	607
479F-20	7314150441990	6	607
479F-24	7314150442003	6	607
479F-32	7314150442010	6	607



480-08	7311518025496	4	608
480-10	7311518025502	6	608
480-12	7311518025519	6	608
480-14	7311518025526	4	608
480-20	7314150319763	4	608
481-100	7311518005030	6	607
481-1000	7311518005092	6	607
481-1500	7311518025533	6	607
481-200	7311518005047	6	607
481-2000	7314150319855	6	607
481-300	7311518005054	6	607
481-400	7311518005061	6	607
481-500	7311518005078	6	607
481-800	7311518025540	6	607
481F-100	7314150442072	6	607
481F-1000	7314150442133	6	607
481F-1500	7314150442140	4	607
481F-200	7314150442089	4	607
481F-2000	7314150442157	4	607
481F-300	7314150442096	6	607
481F-400	7314150442102	6	607
481F-500	7314150442119	6	607
481F-800	7314150442126	6	607
482-25	7311518025557	6	607
482-28	7311518025564	6	607
482-30	7311518025571	6	607
482-35	7311518025595	6	607
482-40	7311518025601	6	607
482-45	7311518027551	6	607
482F-25	7314150442225	4	607
482F-28	7314150442232	4	607
482F-30	7314150442249	6	607
482F-35	7314150442256	4	607
482F-40	7314150442263	2	607
482F-45	7314150442270	4	607
483-16	7311518024314	6	608
483-20	7311518024321	6	608
483-22	7311518005108	6	608
483-25	7311518005115	6	608
483-28	7311518024284	6	608
483-30	7311518024291	6	608
4830	7314150100057	3	242
4831	7314150103393	3	242
4833	7314150100064	3	243
483F-16	7314150442164	6	608
483F-20	7314150442171	6	608
483F-22	7314150442188	6	608
483F-25	7314150442195	6	608
483F-28	7314150442201	6	608
483F-30	7314150442218	4	608
484-1000	7311518005122	6	608
484-1250	7311518005139	6	608
484-1500	7311518005146	6	608
484-2000	7311518024338	4	608
484F-1000	7314150442027	6	608
484F-1250	7314150442034	6	608
484F-1500	7314150442041	6	608
484F-2000	7314150442058	4	608
485	7311518005153	6	608
485W-650	7314150319770	6	608
485W-750	7314150319787	6	608
486	7311518005160	4	609
486-1800	7314150315307	5	555
486-1800WH	7314150315338	5	555
486-2000	7314150315314	5	555
486-2000WH	7314150315345	5	555
486-2400	7314150315321	5	555
486-2400WH	7314150315352	5	555
486-700	7314150338078	6	609
486F-700	7314150338085	6	609
486W-500	7314150319794	4	609
486W-600	7314150319800	4	609
488-2000	7314150337972	2	609
488-3000	7314150337989	2	609
488-4000	7314150337996	2	609
488-5000	7314150338009	2	609
488-6000	7314150338016	1	609
488F-2000	7314150338023	2	609
488F-3000	7314150338030	2	609
488F-4000	7314150338047	2	609
488F-5000	7314150338054	4	609
488F-6000	7314150338061	2	609
489-1100	7314150133055	8	611
489-1800	7314150133062	8	611
489-2700	7314150133079	4	611
489-3600	7314150133086	4	611
489-4500	7314150133093	4	611
489-5400	7314150133109	4	611
490-3.5	7311518025373	4	608
491-3000	7314150345199	4	611
491-4000	7314150345205	4	611
491-5000	7314150345212	4	611
491-6000	7314150345229	4	611
492-3.5	7311518025380	4	608
493-500	7314150338139	6	610
493-600	7314150338146	6	610



493F-500



493F-500	7314150338153	6	610
493F-600	7314150338160	1	610
494-600	7311518025397	4	610
495-500	7314150338191	6	610
495-600	7314150338207	6	610
495F-500	7314150338184	6	610
495F-600	7314150338177	1	610
496-1500	7314150315147	5	555
496-1800	7314150315154	5	555
496-SPARE	7314150329304	1	556
4M-10-11	7314151829438	10	53
4M-12-13	7314151829445	10	53
4M-14-15	7314151829476	10	53
4M-16-17	7314151829490	10	53
4M-17-19	7314151829506	10	53
4M-18-19	7314151829513	10	53
4M-20-22	7314151829520	10	53
4M-21-23	7314150205363	5	53
4M-24-26	7314150205370	1	53
4M-24-27	7314151829551	1	53
4M-25-28	7314150205387	1	53
4M-27-29	7314150205394	1	53
4M-30-32	7314151829575	1	53
4M-6-7	7314151829407	10	53
4M-8-9	7314151829414	10	53
4M/10C	7314150212972	1	53
4M/10T	7314151829605	1	53
4M/12C	7314150212989	1	53
4M/8	7314150180493	1	54
5-600-21-D-1P	7311518189341	10	35
5-610-21-D-1P	7311518189358	5	35
5-630-21-D-1P	7311518189365	1	35
5-670-21-D-1P	7311518189389	1	35
500-12	7314150390977	1	271
500-14	7314150414505	1	271
500-15	7314150390984	1	271
500-16	7314150414512	1	271
500-18	7314150414543	1	271
500-22	7314150414567	1	271
502	7311518130589	25	580
502-SET2	7311518130664	35	580
502-SET6	7311518130633	10	580
5050	7314151083359	1	362
51-12	7311518044565	10	648
51-21	7311518003906	10	648
51-24	7311518003913	10	648
51-30	7311518003920	10	648
51-32	7311518003937	10	648
51-36	7311518003944	10	648
510031	7314150216338	5	214
510033	7314150216345	5	214
510034	7314150216314	10	214
5124-JS-H	7311518219352	4	649
5128-JS-H	7311518219369	4	649
52	7311518276027	12	309
527 D-160	7314150032723	5	236
527 D-200	7314150032730	5	236
527 GC-160	7314150205653	3	236
527 GC-200	7314150205660	3	236
527V-160	7314150126811	2	509
527V-200	7314150126828	2	509
528-700	7311518188993	1	587
528-COM	7311518188986	1	587
529-16-L	7314150198139	4	606
529-16-XL	7314150198146	4	606
529-20-L	7314150198160	4	606
529-20-XL	7314150198153	4	606
529S-16-XL	7314150340330	4	606
529S-20-XL	7314150340347	4	606
541 D-150	7314150032754	5	237
541 D-200	7314150032761	5	237
541 D-250	7314150032778	5	237
5418	7314151084370	1	548
5419/6T	7314151821562	1	548
541D-180	7314150127160	5	237
541D-225	7314150127290	5	237
5463 R	7314151085063	5	546
5463-120	7314151085001	5	546
5464-105	7314151085087	5	546
54640	7314150215720	1	169
5465 AMT	7314151085148	5	544
5465 R	7314151085162	5	546
5468-112	7314151085247	5	544
5469 AMI	7314151337803	1	544
5469 B	7314151085322	5	544
5469 BI	7314151085346	5	544
5469 I	7314151085407	5	544
5469 R	7314151085421	5	544
5469-127	7314151085285	5	544
5470 I-160	7314151085520	5	546
5470-120	7314151085452	5	546
5471 F-120	7314151085681	5	544
5471 F-145	7314151085704	5	544
5471 F-200	7314151085728	5	544
5471 F-250	7314151085742	5	544
5471 F-300	7314151085766	5	544



5471 FI-120	7314151085780	5	544
5471 FI-200	7314151085827	5	544
5471 FR-120	7314151085889	5	544
5471 FR-145	7314151085902	5	544
5475 K	7314151086244	5	544
5475 R	7314151086268	5	544
5476 H	7314151086305	5	547
5479-130	7314151086398	5	544
5488 AM	7314151821166	5	545
5489 AM	7314151821173	5	545
5490 AM	7314151821180	5	545
5493-115	7314151821234	5	546
5515B	7314151086978	25	363
5515FL	7314150504077	10	362
5515GV	7314151481483	1	362
5515L	7314151481568	1	363
5515M	7314151086985	1	363
5515T	7314151589172	25	363
5515T-52	7314153021939	25	362
5516	7314151086992	5	544
5516 I	7314151087029	5	544
5517	7314151573843	5	544
5517 I	7314151573928	5	544
5518	7314151087043	5	544
5521	7314150215713	1	169
5540 AM	7314151821319	5	545
5541 AM	7314151821326	5	545
5544 AM	7314151821357	5	545
5545 AM	7314151821364	5	545
5546 AM	7314151821371	5	545
5547 AM	7314151821388	5	545
5549 AM	7314151821401	5	545
5550-3.2	7314151475673	10	548
5550-4.5	7314151475758	10	548
5551	7314151378479	1	549
5552	7314151378554	1	549
5553	7314151378639	1	549
5554	7314151378714	1	549
5568/5	7314151821210	1	546
5573-145	7314151473112	5	545
5574-145	7314151473389	5	547
5577-145	7314151574062	5	546
5578-115	7314151547769	5	545
5579-115	7314151547844	5	546
5588 AM	7314151821432	5	546
5589 AM	7314151821449	5	546
5590 AM	7314151821456	5	546
5600/4	7314151436773	1	549
5724-JS	7311518216085	1	650
5728-JS	7311518216092	1	650
5750	7311518280949	1	344
5770	7314150504466	12	344
583D	7314150023721	4	591
584D	7314150023745	4	591
585D	7314150104185	4	591
586D	7314150104208	4	591
59/S100BC	7314150337637	1	167
59/S100BC-IP	7314150337644	8	167
59/S10BC	7314150413003	1	165
59/S28-4	7314151847109	1	166
59/S31B	7314150325788	6	166
59/S31B-IP	7314150325795	12	166
59/S35BC	7314150412990	1	167
59/S36BCR	7314150413232	6	210
59/S54BC	7314150337613	10	167
59/S54BC-IP	7314150337620	8	167
59S/0.5-3.0	7314150199815	1	160
59S/0.5-3.0-3P	7314150259205	50	160
59S/0.5-4.0	7314150199822	1	160
59S/0.5-4.0-3P	7314150259212	1	160
59S/0.6-3.5	7314150199839	50	160
59S/0.6-3.5-3P	7314150259229	50	160
59S/0.6-4.5	7314150198801	1	160
59S/0.6-4.5-3P	7314150201600	1	160
59S/0.8-5.5	7314150198849	1	160
59S/0.8-5.5-3P	7314150201624	1	160
59S/1.0-5.5	7314150198863	1	160
59S/1.0-5.5-3P	7314150258963	50	160
59S/1.2-6.5	7314150198887	1	160
59S/1.2-6.5-3P	7314150258970	50	160
59S/1.2-8.0	7314150198900	1	160
59S/1.2-8.0-3P	7314150258987	1	160
59S/1.6-10	7314150199846	1	160
59S/1.6-10-3P	7314150259236	50	160
59S/1.6-9.0	7314150199853	1	160
59S/1.6-9.0-3P	7314150259243	50	160
59S/125PH1	7314150206834	1	164
59S/125PH1-2P	7314150260553	25	164
59S/125PH2	7314150204298	1	164
59S/125PH2-2P	7314150260560	25	164
59S/125PH2-IP	7314150342433	100	164
59S/125PH3	7314150204304	1	164
59S/125PH3-2P	7314150260577	25	164
59S/125PZ1	7314150200733	1	164
59S/125PZ1-2P	7314150260522	25	164
59S/125PZ2	7314150200740	1	164



59S/125PZ2-2P	7314150260539	25	164
59S/125PZ3	7314150200757	1	164
59S/125PZ3-2P	7314150260546	25	164
59S/150T15	7314150200764	1	164
59S/150T15-2P	7314150260584	1	164
59S/150T20	7314150200771	1	164
59S/150T20-2P	7314150260591	1	164
59S/150T25	7314150200788	1	164
59S/150T25-2P	7314150260607	1	164
59S/150T30	7314150200795	1	164
59S/150T30-2P	7314150260614	1	164
59S/17-1	7314150191499	1	165
59S/17-2	7314150191505	1	166
59S/17-3	7314150191512	1	166
59S/22-1	7314150204229	12	166
59S/22-2	7314150204236	12	166
59S/31-1	7314150191451	12	166
59S/31-2	7314150191468	1	167
59S/31-3	7314150191475	12	167
59S/50/0.6-3.5	7314150199976	1	162
59S/50/0.8-4.0	7314150200009	1	162
59S/50/0.8-5.5	7314150200023	1	162
59S/50/1.0-6.0	7314150200047	1	162
59S/50/1.2-6.5	7314150200061	1	162
59S/50/3.5-2P	7314150260027	50	162
59S/50/4.0-2P	7314150260041	50	162
59S/50/5.5-2P	7314150260065	50	162
59S/50/6.0-2P	7314150260089	1	162
59S/50/6.5-2P	7314150260102	50	162
59S/50H1/16	7314150248926	1	163
59S/50H1/4	7314150249015	1	163
59S/50H1/8	7314150248964	1	163
59S/50H2	7314150200160	1	163
59S/50H2-2P	7314150259298	50	163
59S/50H2.5	7314150200177	1	163
59S/50H2.5-2P	7314150259304	50	163
59S/50H3	7314150200184	1	163
59S/50H3-2P	7314150259335	50	163
59S/50H3/16	7314150248995	1	163
59S/50H3/32	7314150248940	1	163
59S/50H3/8	7314150249039	1	163
59S/50H4	7314150200191	1	163
59S/50H4-2P	7314150259359	50	163
59S/50H5	7314150200207	1	163
59S/50H5-2P	7314150259373	50	163
59S/50H5/16	7314150249022	1	163
59S/50H5/32	7314150248988	1	163
59S/50H5/64	7314150248933	1	163
59S/50H6	7314150200214	1	163
59S/50H6-2P	7314150259397	50	163
59S/50H7/32	7314150249008	1	163
59S/50H7/64	7314150248957	1	163
59S/50H8	7314150200221	1	163
59S/50H8-2P	7314150259410	50	163
59S/50H9/64	7314150248971	1	163
59S/50PH1	7314150199860	1	162
59S/50PH1-2P	7314150203642	1	162
59S/50PH2	7314150199877	1	162
59S/50PH2-2P	7314150203758	1	162
59S/50PH3	7314150199891	1	162
59S/50PH3-2P	7314150203802	1	162
59S/50PZ1	7314150199914	1	163
59S/50PZ1-2P	7314150204007	1	163
59S/50PZ2	7314150199938	1	163
59S/50PZ2-2P	7314150204014	1	163
59S/50PZ3	7314150199952	1	163
59S/50PZ3-2P	7314150204021	1	163
59S/50R1	7314150200238	1	163
59S/50R1-2P	7314150259441	50	163
59S/50R2	7314150200245	1	163
59S/50R2-2P	7314150259472	50	163
59S/50R3	7314150200252	1	163
59S/50R3-2P	7314150259502	50	163
59S/50T10	7314150200092	1	163
59S/50T10-2P	7314150201723	1	163
59S/50T15	7314150200108	1	163
59S/50T15-2P	7314150201730	1	163
59S/50T20	7314150200115	1	163
59S/50T20-2P	7314150201747	1	163
59S/50T25	7314150200122	1	163
59S/50T25-2P	7314150201754	1	163
59S/50T27	7314150200139	1	163
59S/50T30	7314150200146	1	163
59S/50T30-2P	7314150201761	1	163
59S/50T40	7314150200153	1	163
59S/50T40-2P	7314150259281	50	163
59S/50T8	7314150200085	1	163
59S/50T8-2P	7314150262809	50	163
59S/60PEN/DISP	7314150459032	1	168
59S/7-1	7314150191536	1	165
59S/7-2	7314150191543	1	165
59S/7-3	7314150191550	1	165
59S/7-4	7314150191567	1	165
59S/70PH1	7314150200269	1	163
59S/70PH1-2P	7314150259526	1	163
59S/70PH2	7314150200276	1	163



59S/70PH2-2P	7314150259557	25	163
59S/70PZ1	7314150200283	1	163
59S/70PZ1-2P	7314150259564	1	163
59S/70PZ2	7314150200290	1	163
59S/70PZ2-2P	7314150260331	1	163
59S/70PZ3	7314150200306	1	163
59S/70PZ3-2P	7314150260348	1	163
59S/70T10	7314150200313	1	163
59S/70T10-2P	7314150260355	1	163
59S/70T15	7314150200566	1	163
59S/70T15-2P	7314150260362	25	163
59S/70T20	7314150200573	1	163
59S/70T20-2P	7314150201839	1	163
59S/70T25	7314150200580	1	163
59S/70T25-2P	7314150260379	25	163
59S/70T27	7314150200597	1	163
59S/70T27-2P	7314150260386	1	163
59S/70T30	7314150200603	1	163
59S/70T30-2P	7314150260393	1	163
59S/70T40	7314150200610	1	163
59S/70T40-2P	7314150260409	1	163
59S/70TR15	7314150200627	1	164
59S/70TR15-2P	7314150260416	1	164
59S/70TR20	7314150200634	1	164
59S/70TR20-2P	7314150260423	25	164
59S/70TR25	7314150200641	1	164
59S/70TR25-2P	7314150260430	25	164
59S/70TR27	7314150200658	1	164
59S/70TR27-2P	7314150260447	25	164
59S/70TR30	7314150200665	1	164
59S/70TR30-2P	7314150260454	25	164
59S/70TR40	7314150200672	1	164
59S/70TR40-2P	7314150260461	25	164
59S/H1.5	7314150198924	1	161
59S/H1.5-3P	7314150258994	50	161
59S/H1/16	7314150204205	1	162
59S/H1/16-3P	7314150259021	50	162
59S/H1/4	7314150199266	1	162
59S/H1/4-3P	7314150259120	50	162
59S/H1/8	7314150199174	1	162
59S/H1/8-3P	7314150259069	50	162
59S/H10	7314150199075	1	161
59S/H10-3P	7311518333638	25	161
59S/H2	7314150198955	1	161
59S/H2-3P	7314150259007	50	161
59S/H2.5	7314150198962	1	161
59S/H2.5-3P	7314150259014	50	161
59S/H3	7314150198986	1	161
59S/H3-3P	7314150201662	1	161
59S/H3/16	7314150199228	1	162
59S/H3/16-3P	7314150259090	1	162
59S/H3/32	7314150199136	1	162
59S/H3/32-3P	7314150259045	50	162
59S/H3/8	7314150204212	1	162
59S/H3/8-3P	7314150259144	25	162
59S/H3BALL	7314150200689	1	164
59S/H3BALL-2P	7314150260478	1	161
59S/H4	7314150198993	1	161
59S/H4-3P	7314150201679	1	161
59S/H4-IPB	7314150225767	500	161
59S/H4BALL	7314150200696	1	164
59S/H4BALL-2P	7314150260485	1	164
59S/H5	7314150199013	1	161
59S/H5-3P	7314150201686	1	161
59S/H5/16	7314150199273	1	162
59S/H5/16-3P	7314150259137	50	162
59S/H5/32	7314150199204	1	162
59S/H5/32-3P	7314150259083	50	162
59S/H5/64	7314150199112	1	162
59S/H5/64-3P	7314150259038	50	162
59S/H5BALL	7314150200702	1	164
59S/H5BALL-2P	7314150260492	1	164
59S/H6	7314150199037	1	161
59S/H6-3P	7314150201693	1	161
59S/H6BALL	7314150200719	1	164
59S/H6BALL-2P	7314150260508	1	164
59S/H7/32	7314150199242	1	162
59S/H7/32-3P	7314150259113	50	162
59S/H7/64	7314150199150	1	162
59S/H7/64-3P	7314150259052	50	162
59S/H8	7314150199051	1	161
59S/H8-3P	7314150201709	1	161
59S/H8BALL	7314150200726	1	164
59S/H8BALL-2P	7314150260515	1	164
59S/H9/64	7314150199198	1	162
59S/H9/64-3P	7314150259076	1	162
59S/HBALL-3P	7314150201716	1	164
59S/M3	7314150199730	1	162
59S/M3-3P	7314150259151	50	162
59S/M4	7314150199754	1	162
59S/M4-3P	7314150259168	50	162
59S/M5	7314150199778	1	162
59S/M5-3P	7314150259175	50	162
59S/M6	7314150199792	1	162
59S/M6-3P	7314150259182	50	162
59S/M8	7314150199808	1	162



59S/M8-3P



59S/M8-3P	7314150259199	50	162
59S/PH0	7314150198177	1	160
59S/PH0-3P	7314150258819	50	160
59S/PH1	7314150198313	1	160
59S/PH1-30P	7314150200801	1	160
59S/PH1-3P	7314150201396	1	160
59S/PH1-IP	7314150206780	100	160
59S/PH1-IPB	7314150225743	500	160
59S/PH1COMBI-2P	7314150215669	1	164
59S/PH2	7314150198320	1	160
59S/PH2-30P	7314150200818	1	160
59S/PH2-3P	7314150201402	1	160
59S/PH2-IP	7314150206797	100	160
59S/PH2-IPB	7314150204038	500	160
59S/PH2COMBI-2P	7314150203604	1	164
59S/PH2G	7314150204182	1	160
59S/PH2G-30P	7314150200832	1	160
59S/PH2G-3P	7314150259250	50	160
59S/PH2PEN	7314150458950	10	168
59S/PH3	7314150198351	1	160
59S/PH3-30P	7314150200825	1	160
59S/PH3-3P	7314150201419	1	160
59S/PH3-IPB	7314150225750	500	160
59S/PH3COMBI-2P	7314150203611	1	164
59S/PH4	7314150198368	1	160
59S/PH4-3P	7314150258826	25	160
59S/PZ0	7314150198375	1	161
59S/PZ0-3P	7314150258833	50	161
59S/PZ1	7314150198382	1	161
59S/PZ1-30P	7314150200849	1	161
59S/PZ1-3P	7314150201426	1	161
59S/PZ1-IP	7314150206803	100	161
59S/PZ1-IPB	7314150204373	500	161
59S/PZ2	7314150198405	1	161
59S/PZ2-30P	7314150200856	1	161
59S/PZ2-3P	7314150201433	1	161
59S/PZ2-IP	7314150206810	100	161
59S/PZ2-IPB	7314150204380	500	161
59S/PZ2PEN	7314150458974	10	168
59S/PZ3	7314150198429	1	161
59S/PZ3-30P	7314150200863	1	161
59S/PZ3-3P	7314150201440	1	161
59S/PZ3-IPB	7314150225736	500	161
59S/PZ4	7314150198436	1	161
59S/R1	7314150199310	1	162
59S/R1-3P	7314150201631	1	162
59S/R2	7314150199341	1	162
59S/R2-3P	7314150201648	1	162
59S/R3	7314150199365	1	162
59S/R3-3P	7314150201655	1	162
59S/R4	7314150232109	1	162
59S/T10	7314150198528	1	161
59S/T10-30P	7314150200870	1	161
59S/T10-3P	7314150201457	1	161
59S/T10CS	7314150444014	20	161
59S/T15	7314150198535	1	161
59S/T15-30P	7314150200887	1	161
59S/T15-3P	7314150201464	1	161
59S/T15CS	7314150444021	20	161
59S/T15PEN	7314150458929	10	168
59S/T20	7314150198542	1	161
59S/T20-30P	7314150200894	1	161
59S/T20-3P	7314150201471	1	161
59S/T20CS	7314150444038	20	161
59S/T20PEN	7314150458936	10	168
59S/T25	7314150198566	1	161
59S/T25-30P	7314150200900	1	161
59S/T25-3P	7314150201488	1	161
59S/T25CS	7314150444045	20	161
59S/T25PEN	7314150458943	10	168
59S/T27	7314150198580	1	161
59S/T27-3P	7314150201495	1	161
59S/T27CS	7314150444052	20	161
59S/T3	7314150198443	1	161
59S/T3-3P	7314150258840	50	161
59S/T30	7314150198597	1	161
59S/T30-30P	7314150200924	1	161
59S/T30-3P	7314150201501	1	161
59S/T30CS	7314150444069	20	161
59S/T4	7314150198450	1	161
59S/T4-3P	7314150258857	50	161
59S/T40	7314150198610	1	161
59S/T40-30P	7314150200931	1	161
59S/T40-3P	7314150201518	1	161
59S/T40CS	7314150444076	20	161
59S/T45	7314150198641	1	161
59S/T45-3P	7314150258918	50	161
59S/T5	7314150198467	1	161
59S/T5-3P	7314150258864	50	161
59S/T50	7314150198658	1	161
59S/T50-3P	7314150258925	50	161
59S/T6	7314150198474	1	161
59S/T6-3P	7314150258871	50	161
59S/T7	7314150198498	1	161
59S/T7-3P	7314150258888	50	161
59S/T8	7314150198504	1	161



59S/T8-3P	7314150258895	50	161
59S/T9	7314150198511	1	161
59S/T9-3P	7314150258901	50	161
59S/TCS11-1	7314150444083	10	165
59S/TR10	7314150198702	1	161
59S/TR10-3P	7314150201525	1	161
59S/TR15	7314150198719	1	161
59S/TR15-3P	7314150201532	1	161
59S/TR20	7314150198726	1	161
59S/TR20-3P	7314150201549	1	161
59S/TR25	7314150198740	1	161
59S/TR25-3P	7314150201556	1	161
59S/TR27	7314150198757	1	161
59S/TR27-3P	7314150201570	1	161
59S/TR30	7314150198771	1	161
59S/TR30-3P	7314150201587	1	161
59S/TR40	7314150198795	1	161
59S/TR40-3P	7314150201594	1	161
59S/TR7	7314150198672	1	161
59S/TR7-3P	7314150258932	50	161
59S/TR8	7314150198689	1	161
59S/TR8-3P	7314150258949	50	161
59S/TR9	7314150198696	1	161
59S/TR9-3P	7314150258956	50	161
59S/TS-0	7314150199389	1	162
59S/TS-1	7314150199396	1	162
59S/TS-1/4	7314150199594	1	162
59S/TS-10	7314150199570	1	162
59S/TS-2	7314150199419	1	162
59S/TS-3	7314150199433	1	162
59S/TS-4	7314150199457	1	162
59S/TS-5	7314150199518	1	162
59S/TS-6	7314150199532	1	162
59S/TS-8	7314150199556	1	162
59S/TW0	7314150199617	1	162
59S/TW1	7314150199631	1	162
59S/TW2	7314150199655	1	162
59S/TW3	7314150199679	1	162
59S/TW4	7314150199693	1	162
59S/TW5	7314150199716	1	162
6	8412814220048	1	217
6-342-06-2-0	7311518021719	10	30
6-342-06-2-2	7311518244170	5	30
6-342-08-1-0	7311518021726	10	30
6-342-08-1-2	7311518028282	5	30
6-342-08-2-0	7311518021733	10	30
6-342-08-2-2	7311518005375	5	30
6-342-10-1-0	7311518021757	10	30
6-342-10-1-2	7311518005382	5	30
6-342-10-2-0	7311518021764	10	30
6-342-10-2-2	7311518005399	5	30
6-343-08-2-0	7311518021801	10	30
6-343-08-2-2	7311518001070	5	30
6-343-08-3-0	7311518021818	10	30
6-343-10-2-0	7311518021825	10	30
6-343-10-2-2	7311518001094	5	30
6-343-10-3-0	7311518021832	10	30
6-344-08-2-0	7311518021887	10	30
6-344-08-2-2	7311518005344	5	30
6-344-10-2-0	7311518021900	10	30
6-344-10-2-2	7311518005351	5	30
6-345-08-1-2	7311518028312	5	31
6-345-08-2-0	7311518021948	10	31
6-345-08-2-2	7311518005412	5	31
6-345-10-1-2	7311518005429	5	31
6-345-10-2-0	7311518021955	10	31
6-470-08-2-2	7311518242008	5	31
600-3	7314150124787	1	208
600.003.010	8412814600000	1	374
600.005.012	8412814600017	1	374
601000800	8413345202299	1	603
601001000	8413345202305	1	603
601001250	8413345202312	1	603
601001500	8413345202329	1	603
6010H0800	8413345015769	1	604
6010H1000	8413345015776	1	604
6010H1250	8413345015783	1	604
6010H1500	8413345015790	1	604
6010M0800	8413345015806	1	603
6010M1000	8413345116619	1	603
6010M1250	8413345015820	1	603
6010M1500	8413345015837	1	603
602-4-LA	7314150224357	1	208
604-5	7314150124800	1	208
6040M0630	8413345124126	1	604
605-10-PC-AU	7314150186334	1	210
605-6	7314150153770	1	209
606-6	7314150124824	1	209
6070H1000	8413345030656	1	603
6070H1250	8413345084833	1	603
6070H1500	8413345030663	1	603
6070H1750	8413345030670	1	603
607201000	8413345030533	1	603
607201250	8413345030540	1	603
607201500	8413345030557	1	603
607201750	8413345030564	1	603

Part Number	Part Number	Quantity	Part Number
6072M1000	8413345015813	1	603
6072M1500	8413345137454	1	603
6072M1750	8413345030687	1	603
60T/17-1	7314150191529	1	158
60T/31-1	7314150191482	12	158
60T/7-1	7314150191574	1	158
60T/PH1	7314150199488	1	158
60T/PH2	7314150199495	1	158
60T/PH3	7314150199501	1	158
60T/PZ1	7314150199525	1	158
60T/PZ2	7314150199549	1	158
60T/PZ3	7314150199563	1	158
60T/T15	7314150199662	1	158
60T/T20	7314150199686	1	158
60T/T25	7314150199709	1	158
60T/T27	7314150199723	1	158
60T/T40	7314150199761	1	158
60T/T7	7314150199587	1	158
60T/T9	7314150199624	1	158
610-6	7314150124848	1	209
611-10-200	7314150124428	10	207
611-3.5-100	7314150124336	10	207
611-3.5-75	7314150124329	10	207
611-4-100	7314150124350	10	207
611-4-75	7314150124343	10	207
611-5.5-100	7314150124367	10	207
611-5.5-125	7314150124381	10	207
611-6.5-125	7314150124374	10	207
611-6.5-150	7314150124398	10	207
611-6.5-25	7314150124602	10	207
611-8-150	7314150124404	10	207
611-8-175	7314150124411	10	207
612-5	7314150124817	1	209
613-3-100	7314150124442	10	207
613-3-75	7314150124435	10	207
613-3.5-100	7314150124459	10	207
613-4-100	7314150124466	10	207
613-4-125	7314150124473	10	207
613-5.5-150	7314150124497	10	207
613-6.5-150	7314150124503	10	207
615-0-75	7314150124558	10	208
615-1-100	7314150124565	10	208
615-2-125	7314150124572	10	208
615-2-25	7314150124596	10	208
615-3-150	7314150124589	10	208
616-0-75	7314150124510	10	208
616-1-100	7314150124527	10	208
616-2-125	7314150124534	10	208
616-3-150	7314150124541	10	208
618-10-75	7314150124619	10	208
618-15-100	7314150124626	10	208
618-20-100	7314150124633	10	208
618-25-125	7314150124640	10	208
618-27-125	7314150124657	10	208
618-30-150	7314150124664	10	208
618-40-150	7314150124671	10	208
61H/50PH1	7314150200382	1	159
61H/50PZ1	7314150200412	1	159
61H/50PZ2	7314150200429	1	159
61H/50PZ3	7314150200436	1	159
61H/50T10	7314150200443	1	159
61H/50T15	7314150200450	1	159
61H/50T25	7314150200474	1	159
61H/50T30	7314150200481	1	159
61H/PH1	7314150199006	1	158
61H/PH2	7314150199020	1	158
61H/PH3	7314150199044	1	158
61H/PZ3	7314150199105	1	159
61H/T10	7314150199129	1	159
61H/T20	7314150199167	1	159
61H/T25	7314150199181	1	159
61H/T40	7314150199235	1	159
620-6	7314150128594	1	507
622-3P	7314150427727	1	248
6221D	7314150421596	10	248
6221D IP	7314150440368	10	248
6222D	7314150421589	10	248
6222D IP	7314150437702	10	248
6223D	7314150421558	8	248
6223D IP	7314150421794	8	248
6224	7314150421619	4	247
6224D	7314150421565	5	248
6224D IP	7314150421800	5	248
6225D	7314150421572	10	248
6225D IP	7314150421817	5	248
623-3-100	7314150128518	10	507
623-3.5-100	7314150128525	10	507
623-4-100	7314150128532	10	507
623-5.5-125	7314150128549	10	507
623-6.5-150	7314150128556	10	507
625	7311518221614	5	562
625-0-100	7314150128563	10	507
625-1-150	7314150128570	10	507
625-2-175	7314150128587	10	507
625-DROP	7311518221638	10	562
625-PEAR	7311518221621	10	562

Part Number	Part Number	Quantity	Part Number
625-ROUND	7311518221645	10	562
62TIN/50PH1	7314150200504	1	157
62TIN/50PH3	7314150200528	1	157
62TIN/50PZ1	7314150200535	1	157
62TIN/50PZ2	7314150200542	1	157
62TIN/50PZ3	7314150200559	1	157
62TIN/7-1	7314150203505	1	157
62TIN/PH1	7314150199259	1	157
62TIN/PZ1	7314150199327	1	157
62TIN/PZ2	7314150199334	1	157
62TIN/PZ3	7314150199358	1	157
62TIN/T15	7314150199402	1	157
62TIN/T20	7314150199426	1	157
62TIN/T25	7314150199440	1	157
62TIN/T30	7314150199464	1	157
63D/50PZ1	7314150200320	1	157
63D/50PZ2	7314150200337	1	157
63D/50PZ3	7314150200344	1	157
63D/7-1	7314150191604	1	157
63D/PH2G	7314150198979	1	156
63D/PH3	7314150198948	1	156
63D/PZ2	7314150198870	1	156
63D/T10	7314150198665	1	156
63D/T15	7314150198733	1	156
63D/T40	7314150198832	1	156
64A/PH1	7314150198481	1	157
64A/PH3	7314150198573	1	157
64A/PZ1	7314150198603	1	158
64A/PZ3	7314150198634	1	158
650	7311518221591	5	562
65I/7-1	7314150204113	1	541
65I/PH1	7314150199785	1	541
65I/PH2	7314150199884	1	541
65I/PH3	7314150199907	1	541
65I/PZ1	7314150199921	1	541
65I/PZ2	7314150199945	1	541
65I/PZ3	7314150199969	1	541
65I/T15	7314150199990	1	541
65I/T40	7314150200078	1	541
665	7311518221607	5	562
66IM/10C-1	7314150450732	40	160
66IM/11C-1	7314150450718	40	160
66IM/50PH1-2P	7314150446056	1	159
66IM/50PH2-2P	7314150446063	1	159
66IM/50PH3-2P	7314150446087	1	159
66IM/50PZ1-2P	7314150446094	1	160
66IM/50PZ2-2P	7314150446108	1	160
66IM/50PZ3-2P	7314150446117	1	160
66IM/50T10C-2P	7314150446131	1	160
66IM/50T15C-2P	7314150446148	1	160
66IM/50T20C-2P	7314150446155	1	160
66IM/50T25C-2P	7314150446162	1	160
66IM/50T27C-2P	7314150446179	1	160
66IM/50T30C-2P	7314150446186	1	160
66IM/50T40C-2P	7314150446193	1	160
66IM/PH1-2P	7314150445929	1	159
66IM/PH2-2P	7314150445936	1	159
66IM/PH3-2P	7314150445943	1	159
66IM/PZ1-2P	7314150445950	1	159
66IM/PZ2-2P	7314150445967	1	159
66IM/PZ3-2P	7314150445974	1	159
66IM/T10C-2P	7314150445981	1	159
66IM/T15C-2P	7314150445998	1	159
66IM/T20C-2P	7314150446001	1	159
66IM/T25C-2P	7314150446018	1	159
66IM/T27C-2P	7314150446025	1	159
66IM/T30C-2P	7314150446032	1	159
66IM/T40C-2P	7314150446049	1	159
6700SM-10	7314151088026	5	79
6700SM-11	7314151088033	5	79
6700SM-12	7314151088040	5	79
6700SM-13	7314151088057	5	79
6700SM-14	7314151088064	5	79
6700SM-4	7314151087944	5	79
6700SM-4.5	7314151087951	5	79
6700SM-5	7314151087968	5	79
6700SM-5.5	7314151087975	5	79
6700SM-6	7314151087982	5	79
6700SM-7	7314151087999	5	79
6700SM-8	7314151088002	5	79
6700SM-9	7314151088019	5	79
6700SZ-1/2	7314151088194	5	80
6700SZ-1/4	7314151088132	5	80
6700SZ-1/8	7314150346349	5	80
6700SZ-11/32	7314151088163	5	80
6700SZ-3/16	7314151088118	5	80
6700SZ-3/8	7314151088170	5	80
6700SZ-5/16	7314151088156	5	80
6700SZ-5/32	7314151808556	5	80
6700SZ-7/16	7314151088187	5	80
6700SZ-7/32	7314151088125	5	80
6700SZ-9/16	7314151088200	5	80
6700SZ-9/32	7314151088149	5	80
6700TORX-E10	7314153011725	5	80
6700TORX-E4	7314153011671	5	80
6700TORX-E5	7314153011688	5	80



6700TORX-E6



6700TORX-E6	7314153011695	5	80
6700TORX-E7	7314153011701	5	80
6700TORX-E8	7314153011718	5	80
6706TE	7314150220199	1	69
6708DMB	7314150220205	1	68
6709-IP10	7314150354498	1	84
6709-IP15	7314150354504	1	84
6709-IP20	7314150354511	1	84
6709-IP25	7314150354528	1	84
6709-IP27	7314150354535	1	84
6709-IP30	7314150354542	1	84
6709-IP40	7314150354559	1	84
6709-IP45	7314150354566	1	84
6709-IP6	7314150460373	1	84
6709-IP7	7314150460366	1	84
6709-IP8	7314150460359	1	84
6709-IP9	7314150460342	1	84
6709F-4.5	7314151830762	5	84
6709F-5.5	7314151830779	5	84
6709F-6.5	7314150220397	5	84
6709F-8	7314151830786	5	84
6709HL	7314150128457	1	83
6709M-10	7314150430833	5	85
6709M-3	7314151830656	5	85
6709M-4	7314151830663	5	85
6709M-5	7314151830670	5	85
6709M-6	7314151830687	5	85
6709M-8	7314151830694	5	85
6709PH-1	7314151830700	5	84
6709PH-2	7314151830717	5	84
6709PH-3	7314151830724	5	84
6709PZ-1	7314151830731	5	84
6709PZ-2	7314151830748	5	84
6709PZ-3	7314151830755	5	84
6709TORX-R-T10	7314153002471	1	84
6709TORX-R-T15	7314153002488	1	84
6709TORX-R-T20	7314153002495	1	84
6709TORX-R-T25	7314153002501	1	84
6709TORX-R-T8	7314153002464	1	84
6709TORX-T10	7314151811679	5	84
6709TORX-T15	7314151811686	5	84
6709TORX-T20	7314151811693	5	84
6709TORX-T25	7314151811709	5	84
6709TORX-T27	7314151811716	5	84
6709TORX-T30	7314151811723	5	84
6709TORX-T40	7314153002457	5	84
6709TORX-T6	7314150460540	5	84
6709TORX-T7	7314150460557	5	84
6709TORX-T8	7314153002440	5	84
6709TORX-T9	7314151811662	5	84
671002600	8413345128971	50	567
671002850	8413345128988	1	567
6711MB	7314150220298	1	69
6712R	7314151838225	1	65
6712RN	7314151838232	1	65
6713MH	7314150220212	1	68
6715GE	7314151831370	1	67
6715GJ	7314151831363	1	67
6715MG	7314151831349	1	66
6715MGS	7314151831332	1	65
6715MZ	7314153003218	1	68
6715PZ	7314151837525	1	67
6717MBP	7314150218806	1	66
6719MHR	7314150218783	1	65
6719SM	7314151820817	1	66
6720NM	7314151088262	1	67
6721NM	7314151088309	1	66
6722M	7314151594411	1	67
6729MHP	7314150218752	1	66
6729MHR	7314150218769	1	65
6729SM	7314153003225	1	68
6729SZ	7314153003232	1	68
6730MBP	7314150218776	1	66
677-10	7314150362486	1	50
677-13	7314150362493	1	50
677-3/8	7314150362509	1	50
677-7	7314150362455	1	50
677-8	7314150362462	1	50
677-9	7314150362479	1	50
679-1/2	7314150363384	1	54
679-10	7314150357345	1	54
679-11	7314150357352	1	54
679-12	7314150357369	1	54
679-13	7314150357376	1	54
679-14	7314150357383	1	54
679-3/8	7314150363360	1	54
679-7	7314150357536	1	54
679-7/16	7314150363377	1	54
679-8	7314150357079	1	54
679-9	7314150357338	1	54
679-9/16	7314150363391	1	54
6821NZ	7314151089269	1	68
6852-5	7314150125463	1	113
6852-5/S17	7314150135875	1	113
6852P-5	7314150416585	1	114
6876N	7314151845575	1	114



6878N	7314151845582	1	114
6880N	7314151845599	1	114
690000160	8413345008068	1	624
690000200	8413345008082	1	624
690000220	8413345008099	1	624
690000250	8413345008105	1	624
690000300	8413345008129	1	624
690000320	8413345087476	1	624
690000350	8413345008136	1	624
690000400	8413345008143	1	624
690000500	8413345008167	1	624
690000630	8413345111065	1	624
69079019P	8413345111089	1	624
690900080	8413345016209	4	624
690900100	8413345016216	4	624
690900120	8413345016223	2	624
690900140	8413345016230	2	624
690900200	8413345016247	1	624
6950	7314151089641	1	85
6950-SPARE	7314150187867	1	86
6950RN	7314151831189	1	85
6950RN-SPARE	7314150209149	1	86
6950SL	7314150197668	1	85
6950SL-SPARE	7314150210251	1	86
6951	7314151089764	1	86
6954	7314151089795	1	82
6956	7314151089825	10	82
6958-6	7314150476329	1	82
6960	7314151089856	1	82
6960W-2	7314150470860	10	82
6960W-4	7314150470877	1	82
6960W-6	7314150470884	10	82
6961	7314151089870	1	82
6962	7314151089894	1	82
6962L	7314151089917	1	82
6963	7314151089931	1	82
6966	7314151089986	10	82
6968	7314150128426	1	83
6969	7314150489268	1	83
696EX-01	7314150386192	1	82
696EX-06	7314150386239	1	82
696EX-08	7314150386246	1	82
696EX-11	7314150386208	1	82
6972H	7314151215934	5	83
6973A	7314150339495	10	83
6973M	7314150339501	1	83
6973N	7314151845605	1	113
6976N	7314151845612	1	113
6978N	7314151845629	1	113
6M-10-11	7314151832094	10	48
6M-10-13	7314151832117	10	48
6M-12-13	7314151832131	10	48
6M-12-14	7314151832148	10	48
6M-13-14	7314151832155	10	48
6M-13-15	7314151832162	10	48
6M-13-16	7314151832179	10	48
6M-13-17	7314151832186	10	48
6M-14-15	7314151832193	10	48
6M-14-17	7314151832209	10	48
6M-16-17	7314151832216	10	48
6M-16-18	7314151832223	10	48
6M-17-19	7314151832230	10	48
6M-18-19	7314151832247	10	48
6M-19-22	7314151832261	10	48
6M-19-24	7314151832278	10	48
6M-20-22	7314151832285	10	48
6M-21-23	7314151832292	10	48
6M-21-24	7314151838072	10	48
6M-22-24	7314151832308	10	48
6M-24-26	7314151832315	10	48
6M-24-27	7314151832322	10	48
6M-24-30	7314151832339	5	48
6M-25-28	7314151832353	5	48
6M-27-29	7314150189861	5	48
6M-27-30	7314151832360	5	48
6M-27-32	7314151832377	5	48
6M-30-32	7314151832384	5	48
6M-30-36	7314151832407	5	48
6M-32-36	7314151832414	5	48
6M-34-36	7314151832421	1	48
6M-36-41	7314151832438	1	48
6M-38-42	7314151832445	1	48
6M-4-5	7314151832018	10	48
6M-4.5-5.5	7314151832025	10	48
6M-4-1-46	7314151832452	1	48
6M-46-50	7314151832469	1	48
6M-5-5.5	7314151832032	10	48
6M-5.5-7	7314151832049	10	48
6M-6-7	7314151832056	10	48
6M-7-8	7314151832063	10	48
6M-8-10	7314151832087	10	48
6M-8-9	7314151832070	10	48
6M/10C	7314150212934	1	50
6M/12C	7314150212941	1	50
6M/6C	7314150212910	1	50
6M/8C	7314150212927	1	50

6M/S8	7314151832483	1	49
6M/SH12	7314153013439	1	49
6M/SH8	7314150201365	1	49
6MV-10	7314150120871	5	511
6MV-11	7314150120888	5	511
6MV-12	7314150120895	5	511
6MV-13	7314150120901	5	511
6MV-14	7314150120918	5	511
6MV-15	7314150120925	5	511
6MV-16	7314150120932	5	511
6MV-17	7314150120949	3	511
6MV-18	7314150120956	3	511
6MV-19	7314150120963	3	511
6MV-20	7314150120970	3	511
6MV-21	7314150120987	3	511
6MV-22	7314150120994	3	511
6MV-23	7314150121007	3	511
6MV-24	7314150121014	3	511
6MV-27	7314150121021	2	511
6MV-30	7314150121038	2	511
6MV-32	7314150121052	2	511
6MV-6	7314150120833	5	511
6MV-7	7314150120840	5	511
6MV-8	7314150120857	5	511
6MV-9	7314150120864	5	511
6MV/10T	7314150213023	1	514
6MV/8T	7314150122141	1	514
6Z-1-1.1/8	7314151832674	1	48
6Z-1.1/16-1.1/4	7314151832681	1	48
6Z-1.1/4-1.3/8	7314151832698	1	48
6Z-1/2-9/16	7314151832568	5	48
6Z-1/4-5/16	7314151832520	5	48
6Z-11/16-3/4	7314151832612	5	48
6Z-13/16-7/8	7314151832643	5	48
6Z-15/16-1	7314151832667	5	48
6Z-19/32-11/16	7314151832582	5	48
6Z-25/32-13/16	7314151832636	5	48
6Z-3/4-7/8	7314151832629	5	48
6Z-3/8-7/16	7314151832544	5	48
6Z-5/16-11/32	7314151832537	5	48
6Z-5/8-3/4	7314151832605	5	48
6Z-7/16-1/2	7314151832551	5	48
6Z-7/8-15/16	7314151832650	5	48
6Z-9/16-5/8	7314151832575	5	48
6Z/8C	7314150212958	1	50
700-1-50	7314153017673	5	212
700-1.2-50	7314153017680	5	212
700-1.5-50	7314153017697	5	212
700-1.8-50	7314153017703	5	212
700-2-50	7314153017710	5	212
700-2.5-50	7314153017741	5	212
700-3-100	7314153017772	5	212
700-3-200	7314153017789	5	212
700-3-50	7314153017765	5	212
700-3.5-75	7314153017796	5	212
700-4-250	7314153017819	5	212
700-4-75	7314153017802	5	212
701-0-200	7314153017857	5	212
701-0-50	7314153017840	5	212
701-00-50	7314153017833	5	212
701-1-250	7314153017871	5	212
701-1-75	7314153017864	5	212
702-0-50	7314153017888	5	212
702-1-75	7314153017895	5	212
703-10-50	7314153017963	5	212
703-15-75	7314153017970	5	212
703-20-75	7314153017987	5	212
703-4-50	7314153017901	5	212
703-5-50	7314153017918	5	212
703-6-50	7314153017925	5	212
703-7-50	7314153017932	5	212
703-8-50	7314153017949	5	212
703-9-50	7314153017956	5	212
704-1.5-50	7314153017994	5	212
704-2-50	7314153018007	5	212
704-2.5-50	7314153018014	5	212
704-3-75	7314153018021	5	212
704Z-3/32	7314150137428	5	212
706-1	7314153018045	1	212
706-2	7314153018052	1	213
706-3	7314153018069	1	213
706-4	7314153018076	1	213
706-5	7314153018083	1	213
70S/1.2-8.0	7314150218387	1	168
70S/1.2-8.0-2P	7314150262823	25	168
70S/1.6-10.0	7314150218394	1	168
70S/1.6-10.0-2P	7314150261017	25	168
70S/1.6-9.0	7314150218400	1	168
70S/1.6-9.0-2P	7314150261024	25	168
70S/2.0-12.0	7314150218417	1	168
70S/2.0-12.0-2P	7314150261086	25	168
70S/2.5-14.0	7314150218424	1	168
70S/2.5-14.0-2P	7314150261147	25	168
70S/H10	7314150218486	1	169
70S/H10-2P	7314150261451	25	169
70S/H12	7314150218493	1	169

70S/H12-2P	7314150261468	25	169
70S/H14	7314150218509	1	169
70S/H14-2P	7314150261475	25	169
70S/H4	7314150218431	1	169
70S/H4-2P	7314150261352	25	169
70S/H5	7314150218448	1	169
70S/H5-2P	7314150261406	25	169
70S/H6	7314150218455	1	169
70S/H6-2P	7314150261437	25	169
70S/H7	7314150218462	1	169
70S/H7-2P	7314150261444	25	169
70S/H8	7314150218479	1	169
70S/H8-2P	7314150262847	25	169
70S/PH1	7314150217557	1	168
70S/PH1-2P	7314150260621	25	168
70S/PH2	7314150217564	1	168
70S/PH2-2P	7314150260638	25	168
70S/PH3	7314150217571	1	168
70S/PH3-2P	7314150260645	25	168
70S/PH4	7314150217588	1	168
70S/PH4-2P	7314150260652	25	168
70S/PZ1	7314150217595	1	169
70S/PZ1-2P	7314150260683	25	169
70S/PZ2	7314150217601	1	169
70S/PZ2-2P	7314150260706	25	169
70S/PZ3	7314150217724	1	169
70S/PZ3-2P	7314150260720	25	169
70S/PZ4	7314150217731	1	169
70S/PZ4-2P	7314150260737	25	169
70S/T20	7314150217748	1	169
70S/T20-2P	7314150260744	25	169
70S/T25	7314150217755	1	169
70S/T25-2P	7314150260812	25	169
70S/T27	7314150217762	1	169
70S/T27-2P	7314150260867	1	169
70S/T30	7314150217779	1	169
70S/T30-2P	7314150260881	25	169
70S/T40	7314150217786	1	169
70S/T40-2P	7314150260898	25	169
70S/T45	7314150217793	1	169
70S/T45-2P	7314150260904	25	169
70S/T50	7314150217809	1	169
70S/T50-2P	7314150260911	25	169
70S/T55	7314150217816	1	169
70S/T55-2P	7314150260928	25	169
70S/TS1/4	7314150218349	1	169
70S/TS1/4-2P	7314150260935	25	169
70S/TS10	7314150218356	1	169
70S/TS10-2P	7314150260942	25	169
70S/TS5/16	7314150218363	1	169
70S/TS5/16-2P	7314150260959	25	169
70S/TS8	7314150218370	1	169
70S/TS8-2P	7314150260966	25	169
7106J	7314150339518	1	89
7223	7314150237722	4	247
7223D	7314150421527	8	247
7223D IP	7314150440306	8	247
7223IP	7314150421855	8	247
7224	7311518274733	4	247
7224-622XD-3P	7314150426973	1	248
7224D	7314150421534	4	247
7224D IP	7314150440313	4	247
7224IP	7314150421831	4	247
7224S	7314150421657	4	511
7225	7314150237739	8	247
7225D	7314150421541	4	247
7225D IP	7314150440320	4	247
7225IP	7314150421848	4	247
7372I-2-63	7314151398668	10	218
7372I-2.5-75	7314151399047	10	218
7372I-3-80	7314151341602	10	218
7400SM-10	7314151092955	5	86
7400SM-11	7314151092962	5	86
7400SM-12	7314151092979	5	86
7400SM-13	7314151092986	5	86
7400SM-14	7314151092993	5	86
7400SM-15	7314151093006	5	86
7400SM-16	7314151831127	5	86
7400SM-17	7314151093020	5	86
7400SM-18	7314151831134	5	86
7400SM-19	7314151093044	5	86
7400SM-20	7314153002570	5	86
7400SM-21	7314153002587	5	86
7400SM-22	7314153002594	5	86
7400SM-6	7314151092917	5	86
7400SM-7	7314151092924	5	86
7400SM-8	7314151092931	5	86
7400SM-9	7314151092948	5	86
7400SR/S12	7314153003294	1	72
7400SZ-1/2	7314150385942	1	87
7400SZ-1/4	7314150385959	1	87
7400SZ-11/16	7314150385966	1	87
7400SZ-11/32	7314150385973	1	87
7400SZ-13/16	7314150385980	1	87
7400SZ-3/4	7314150385997	1	87
7400SZ-3/8	7314150386000	1	87



7400SZ-5/16



7400SZ-5/16	7314150386017	1	87
7400SZ-5/8	7314150386024	1	87
7400SZ-7/16	7314150386031	1	87
7400SZ-7/8	7314150386048	1	87
7400SZ-9/16	7314150386055	1	87
7400TORX-E10	7314153003058	5	88
7400TORX-E11	7314153003065	5	88
7400TORX-E12	7314153003072	5	88
7400TORX-E14	7314153003089	5	88
7400TORX-E16	7314153003096	5	88
7400TORX-E18	7314153003102	5	88
7400TORX-E8	7314150118243	5	88
7400TORX-ER/S7	7314153003300	1	72
7402GPR-16	7314150503087	120	308
7402GPR-18	7314150503094	120	308
7402GPR-21	7314150503100	100	308
7406ZZ-16	7314153011992	1	307
7406ZZ-21	7314153012005	1	307
7407H	7314151218249	1	174
7408H	7314151218300	1	174
7408MD	7314150220328	1	72
7409BH-10	7314153002112	5	91
7409BH-4	7314153002075	5	91
7409BH-5	7314153002082	1	91
7409BH-6	7314153002099	5	91
7409BH-8	7314153002105	5	91
7409F-10	7314153002143	5	90
7409F-6.5	7314153002129	5	90
7409F-8	7314153002136	5	90
7409H	7314151218355	1	174
7409M-10	7314153001962	5	91
7409M-3	7314153002235	5	91
7409M-4	7314153001900	5	91
7409M-5	7314153001917	5	91
7409M-6	7314153001924	5	91
7409M-7	7314153001931	5	91
7409M-8	7314153001948	5	91
7409MB	7314150220236	1	72
7409MR/S7	7314153003256	1	92
7409PH-1	7314153002150	5	91
7409PH-2	7314153002167	5	91
7409PH-3	7314153002174	5	91
7409TORX-R-T27	7314153001856	5	91
7409TORX-R-T30	7314153001863	5	91
7409TORX-R-T40	7314153001870	5	91
7409TORX-R-T45	7314153001887	5	91
7409TORX-R-T50	7314153001894	5	91
7409TORX-T20	7314150220403	5	91
7409TORX-T25	7314153001771	5	91
7409TORX-T25-L	7314153011237	5	91
7409TORX-T27	7314153001788	5	91
7409TORX-T30	7314153001795	5	91
7409TORX-T30-L	7314153011244	5	91
7409TORX-T40	7314153001801	5	91
7409TORX-T40-L	7314153011251	5	91
7409TORX-T45	7314153001818	5	91
7409TORX-T45-L	7314153011268	5	91
7409TORX-T50	7314153001825	5	91
7409TORX-T50-L	7314153011275	5	91
7409TORX-TRR/S5	7314153003263	1	91
7409Z-1/4	7314150386062	1	92
7409Z-1/8	7314150386079	1	92
7409Z-3/16	7314150386086	1	92
7409Z-3/8	7314150386093	1	92
7409Z-5/32	7314150386109	1	92
7409Z-7/32	7314150386116	1	92
7420RE	7314153014962	1	70
7422MBR	7314150218844	1	71
7422MHR	7314150218868	1	71
7429JDE	7314153003348	1	72
7430GE	7314153014979	1	70
7440ME	7314153014986	1	70
7444SG-M-100	7314151830014	1	55
7444SG-M-105	7314151830021	1	55
7444SG-M-110	7314151830038	1	55
7444SG-M-115	7314151830045	1	55
7444SG-M-120	7314151830052	1	55
7444SG-M-125	7314151830069	1	55
7444SG-M-130	7314151830076	1	55
7444SG-M-135	7314151830083	1	55
7444SG-M-140	7314151830090	1	55
7444SG-M-145	7314151830106	1	55
7444SG-M-150	7314151830113	1	55
7444SG-M-155	7314151830120	1	55
7444SG-M-160	7314150132508	1	55
7444SG-M-165	7314150132515	1	55
7444SG-M-170	7314150132522	1	55
7444SG-M-175	7314150132539	1	55
7444SG-M-24	7314150205400	1	55
7444SG-M-27	7314151829834	1	55
7444SG-M-30	7314151829841	1	55
7444SG-M-32	7314151829858	1	55
7444SG-M-34	7314151838560	1	55
7444SG-M-36	7314151829865	1	55
7444SG-M-38	7314150180936	1	55
7444SG-M-41	7314151829872	1	55



7444SG-M-42	7314151829889	1	55
7444SG-M-46	7314151829896	1	55
7444SG-M-50	7314151829919	1	55
7444SG-M-55	7314151829926	1	55
7444SG-M-60	7314151829933	1	55
7444SG-M-65	7314151829940	1	55
7444SG-M-70	7314151829957	1	55
7444SG-M-75	7314151829964	1	55
7444SG-M-80	7314151829971	1	55
7444SG-M-85	7314151829988	1	55
7444SG-M-90	7314151829995	1	55
7444SG-M-95	7314151830007	1	55
7444SG-Z-1.1/16	7314150132546	1	55
7444SG-Z-1.1/2	7314150132614	1	55
7444SG-Z-1.1/4	7314150132577	1	55
7444SG-Z-1.1/8	7314150132553	1	55
7444SG-Z-1.11/16	7314150132638	1	55
7444SG-Z-1.13/16	7314150132652	1	55
7444SG-Z-1.3/16	7314150132560	1	55
7444SG-Z-1.3/4	7314150132645	1	55
7444SG-Z-1.3/8	7314150132591	1	55
7444SG-Z-1.5/16	7314150132584	1	55
7444SG-Z-1.5/8	7314150132621	1	55
7444SG-Z-1.7/16	7314150132607	1	55
7444SG-Z-1.7/8	7314150132669	1	55
7444SG-Z-2	7314150132676	1	55
7444SG-Z-2.1/16	7314150132683	1	55
7444SG-Z-2.1/4	7314150132713	1	55
7444SG-Z-2.1/8	7314150132690	1	55
7444SG-Z-2.3/16	7314150132706	1	55
7444SG-Z-2.3/4	7314150132768	1	55
7444SG-Z-2.3/8	7314150132720	1	55
7444SG-Z-2.5/8	7314150132751	1	55
7444SG-Z-2.9/16	7314150132744	1	55
7444SG-Z-3	7314150132775	1	55
7444SG-Z-3.1/2	7314150132805	1	55
7444SG-Z-3.1/8	7314150132782	1	55
7444SG-Z-3.3/4	7314150132812	1	55
7444SG-Z-3.3/8	7314150132799	1	55
7444SG-Z-3.7/8	7314150132829	1	55
7444SG-Z-4	7314150132836	1	55
7444SG-Z-4.1/2	7314150132850	1	55
7444SG-Z-4.1/8	7314150132843	1	55
7454-1400	7314150119592	1	111
7454-1400E	7314150119615	1	111
7454-140A	7314150509515	1	110
7454-17	7314150509492	1	110
7454-230	7314150509522	1	110
7454-3.5	7314150509478	1	110
7454-32	7314150509508	1	110
7454-480	7314150119578	1	111
7454-480A	7314150509539	1	110
7454-70A	7314150509577	1	110
7454-8.4	7314150509485	1	110
7454-800	7314150119585	1	111
7454-800A	7314150509584	1	110
7454-800E	7314150119608	1	111
7455-100	7314150125111	1	108
7455-1000	7314150368303	1	108
7455-100A	7314150340156	1	108
7455-15	7314150119646	1	108
7455-1500	7314150125166	1	109
7455-20	7314150125074	1	108
7455-200	7314150125128	1	108
7455-25	7314150125081	1	108
7455-2500	7314150125173	1	109
7455-300	7314150125104	1	108
7455-340	7314150125135	1	108
7455-5	7314150119639	1	108
7455-500	7314150125142	1	108
7455-60	7314150125098	1	108
7455-800	7314150125159	1	108
7456-80LB	7314150119783	1	109
7465-100	7314150340200	1	109
7465-15	7314150340170	1	109
7465-1500	7314150340248	1	109
7465-200	7314150340217	1	109
7465-30	7314150340187	1	109
7465-340	7314150340224	1	109
7465-5	7314150340163	1	109
7465-60	7314150340194	1	109
7465-800	7314150340231	1	109
747-1	7314150362899	1	51
747-1.1/16	7314150362905	1	51
747-1.1/2	7314150362974	1	51
747-1.1/4	7314150362936	1	51
747-1.1/8	7314150362912	1	51
747-1.11/16	7314150363001	1	51
747-1.13/16	7314150363025	1	51
747-1.15/16	7314150363049	1	51
747-1.3/16	7314150362929	1	51
747-1.3/4	7314150363018	1	51
747-1.3/8	7314150362950	1	51
747-1.5/16	7314150362943	1	51
747-1.5/8	7314150362998	1	51
747-1.7/16	7314150362967	1	51

Part Number	Quantity	Part Number	Quantity
747-1.7/8	1	7314150363032	51
747-1.9/16	1	7314150362981	51
747-1/2	1	7314150362813	51
747-10	1	7314150362516	51
747-11	1	7314150362523	51
747-11/16	1	7314150362844	51
747-12	1	7314150362530	51
747-13	1	7314150362547	51
747-13/16	1	7314150362868	51
747-14	1	7314150362554	51
747-15	1	7314150362561	51
747-15/16	1	7314150362882	51
747-16	1	7314150362578	51
747-17	1	7314150362585	51
747-18	1	7314150362592	51
747-19	1	7314150362608	51
747-2	1	7314150363056	51
747-2.1/16	1	7314150363063	51
747-2.1/2	1	7314150363131	51
747-2.1/4	1	7314150363094	51
747-2.1/8	1	7314150363070	51
747-2.3/16	1	7314150364893	51
747-2.3/4	1	7314150363162	51
747-2.3/8	1	7314150363117	51
747-2.5/16	1	7314150363100	51
747-2.5/8	1	7314150363155	51
747-2.7/16	1	7314150363124	51
747-2.7/8	1	7314150363179	51
747-2.9/16	1	7314150363148	51
747-20	1	7314150362615	51
747-21	1	7314150362622	51
747-22	1	7314150362639	51
747-23	1	7314150362646	51
747-24	1	7314150362653	51
747-25	1	7314150362660	51
747-26	1	7314150362677	51
747-27	1	7314150362684	51
747-28	1	7314150362691	51
747-3/4	1	7314150362851	51
747-3/8	1	7314150362790	51
747-30	1	7314150362707	51
747-32	1	7314150362714	51
747-34	1	7314150362721	51
747-36	1	7314150362738	51
747-40	1	7314150362745	51
747-41	1	7314150362752	51
747-42	1	7314150362769	51
747-46	1	7314150362776	51
747-5/8	1	7314150362837	51
747-50	1	7314150362783	51
747-7/16	1	7314150362806	51
747-7/8	1	7314150362875	51
747-9/16	1	7314150362820	51
749-1	54	7314150363506	54
749-1.1/16	54	7314150363513	54
749-1.1/2	54	7314150363582	54
749-1.1/4	54	7314150363544	54
749-1.1/8	54	7314150363520	54
749-1.11/16	54	7314150363612	54
749-1.13/16	54	7314150363636	54
749-1.15/16	54	7314150363650	54
749-1.3/16	54	7314150363537	54
749-1.3/4	54	7314150363629	54
749-1.3/8	54	7314150363568	54
749-1.5/16	54	7314150363551	54
749-1.5/8	54	7314150363605	54
749-1.7/16	54	7314150363575	54
749-1.7/8	54	7314150363643	54
749-1.9/16	54	7314150363599	54
749-1/2	54	7314150363421	54
749-11/16	54	7314150363452	54
749-13/16	54	7314150363476	54
749-15	54	7314150357543	54
749-15/16	54	7314150363490	54
749-16	54	7314150357550	54
749-17	54	7314150357567	54
749-18	54	7314150357574	54
749-19	54	7314150357581	54
749-2	54	7314150363667	54
749-2.1/4	54	7314150363698	54
749-2.1/8	54	7314150363674	54
749-2.3/16	54	7314150363681	54
749-2.3/4	54	7314150363728	54
749-2.3/8	54	7314150363704	54
749-2.5/8	54	7314150363711	54
749-20	54	7314150357598	54
749-21	54	7314150357604	54
749-22	54	7314150357611	54
749-23	54	7314150357628	54
749-24	54	7314150357635	54
749-25	54	7314150357642	54
749-26	54	7314150357659	54
749-27	54	7314150357666	54
749-3.1/8	54	7314150363735	54
749-3/4	54	7314150363469	54
749-3/8	54	7314150363407	54

Part Number	Quantity	Part Number	Quantity
749-5/8	1	7314150363445	54
749-7/16	1	7314150363414	54
749-7/8	1	7314150363483	54
749-9/16	1	7314150363438	54
74P14-200	1	7314150416318	112
74P14-300	1	7314150416325	112
74P14-400	1	7314150416332	112
74P9-100	1	7314150416301	112
74P9-20	1	7314150416288	112
74P9-60	1	7314150416295	112
74PR-100	1	7314150416189	111
74PR-100A	1	7314150416196	111
74PR-20	1	7314150416158	111
74PR-200	1	7314150416202	111
74PR-300	1	7314150416219	111
74PR-400	1	7314150416226	111
74PR-60	1	7314150416165	111
74PR-60A	1	7314150416172	111
74PS-100	1	7314150416257	112
74PS-20	1	7314150416233	112
74PS-200	1	7314150416264	112
74PS-300	1	7314150416271	112
74PS-60	1	7314150416240	112
74S/H10	1	7314150218622	164
74S/H10-2P	25	7314150261635	164
74S/H12	1	7314150218639	164
74S/H12-2P	25	7314150261659	164
74S/H14	1	7314150218646	164
74S/H14-2P	1	7314150261666	164
74S/H17	1	7314150218653	164
74S/H17-2P	25	7314150261673	164
74S/H4	1	7314150218578	164
74S/H4-2P	25	7314150261543	164
74S/H5	1	7314150218585	164
74S/H5-2P	25	7314150261550	164
74S/H6	1	7314150218592	164
74S/H6-2P	25	7314150261567	164
74S/H7	1	7314150218608	164
74S/H7-2P	25	7314150261574	164
74S/H8	1	7314150218615	164
74S/H8-2P	25	7314150261611	164
74W14-200	1	7314150415700	108
74W14-300	1	7314150415717	108
74W14-400	1	7314150415724	108
74W9-100	1	7314150415687	108
74W9-15	1	7314150415656	108
74W9-200	1	7314150415694	108
74W9-25	1	7314150415663	108
74W9-50	1	7314150415670	108
74WR-100	1	7314150415540	108
74WR-100B	1	7314150469871	108
74WR-15	1	7314150415519	108
74WR-200	1	7314150415557	108
74WR-25	1	7314150415526	108
74WR-300	1	7314150415564	108
74WR-340	1	7314150415571	108
74WR-400	1	7314150415588	108
74WR-50	1	7314150415533	108
74WS-100	1	7314150415625	108
74WS-15	1	7314150415595	108
74WS-200	1	7314150415632	108
74WS-25	1	7314150415601	108
74WS-300	1	7314150415649	108
74WS-50	1	7314150415618	108
75EXT	113	7314150415311	113
75P1-1500	1	7314150415298	112
75P3-1000	1	7314150415281	112
75P3-650	1	7314150415267	112
75P3-800	1	7314150415274	112
75PS-650	1	7314150415328	112
75R1-1500	1	7314150415236	109
75R3-1000	1	7314150415229	109
75R3-650	1	7314150415205	109
75R3-800	1	7314150415212	109
75S-650	1	7314150415243	110
76R1-2000	1	7314150522378	110
76R3-1000	1	7314150422128	110
76R3-1500	1	7314150422135	110
76R3-600	1	7314150423118	110
76R3-800	1	7314150422111	110
76S-600	1	7314150423125	110
7710	90	7314151551445	90
7750	90	7314151096427	90
7750-SPARE	1	7314150187874	92
7750RN	1	7314151831240	90
7750RN-SPARE	1	7314150209361	92
7750SL	90	7314150197675	90
7750SL-SPARE	1	7314150210268	92
7751	10	7314150386949	10
7752	1	7314151096533	88
7754	1	7314151096557	88
7755-SO/1	1	7314153010728	92
7756	6	7314150489152	88
7759	1	7314151096601	89
7760	1	7314151096618	88
7760W-3	10	7314150470907	88





7760W-6	7314150470914	10	88
7761	7314151096632	1	88
7762	7314151096649	1	88
7764	7314151096670	1	89
7765	7314151096687	1	83
7766	7314151096694	1	89
7767	7314153003577	1	83
7768	7314150128433	1	89
776EX-01	7314150386130	1	89
776EX-03	7314150386154	1	89
776EX-04	7314150386161	1	89
776EX-06	7314150386178	1	89
776EX-08	7314150386185	1	89
776EX-11	7314150386147	1	89
7772H	7314150476336	10	95
7800DM-10	7314151096991	10	93
7800DM-11	7314151097011	10	93
7800DM-12	7314151097035	10	93
7800DM-13	7314151097059	10	93
7800DM-14	7314151097073	10	93
7800DM-15	7314151097097	10	93
7800DM-16	7314151097110	10	93
7800DM-17	7314151097134	10	93
7800DM-18	7314151097158	10	93
7800DM-19	7314151097172	10	93
7800DM-20	7314151097196	10	93
7800DM-21	7314151097219	10	93
7800DM-22	7314151097233	10	93
7800DM-23	7314151097257	10	93
7800DM-24	7314151097271	10	93
7800DM-25	7314151097295	10	93
7800DM-26	7314151097318	10	93
7800DM-27	7314151097332	10	93
7800DM-28	7314151097356	10	93
7800DM-29	7314151097363	10	93
7800DM-30	7314151097370	10	93
7800DM-31	7314150464548	10	93
7800DM-32	7314151097387	10	93
7800DM-33	7314150169351	10	93
7800DM-34	7314150169405	10	93
7800DM-36	7314151097400	10	93
7800DM-8	7314151830854	10	93
7800DM-9	7314151830861	10	93
7800DMV-10	7314150121656	10	512
7800DMV-11	7314150121663	10	512
7800DMV-12	7314150121670	10	512
7800DMV-13	7314150121687	10	512
7800DMV-14	7314150121694	10	512
7800DMV-15	7314150121700	10	512
7800DMV-16	7314150121717	10	512
7800DMV-17	7314150121724	10	512
7800DMV-18	7314150121731	10	512
7800DMV-19	7314150121748	10	512
7800DMV-20	7314150121755	10	512
7800DMV-21	7314150121762	10	512
7800DMV-22	7314150121779	10	512
7800DMV-24	7314150121786	5	512
7800DMV-27	7314150121793	5	512
7800DMV-30	7314150121809	5	512
7800DMV-32	7314150121816	5	512
7800DMV-8	7314150121649	10	512
7800DZ-1	7314151097561	10	94
7800DZ-1.1/16	7314151097578	10	94
7800DZ-1.1/2	7314150464562	10	94
7800DZ-1.1/4	7314151097608	10	94
7800DZ-1.1/8	7314151097585	10	94
7800DZ-1.3/16	7314151097592	10	94
7800DZ-1.3/8	7314150464586	10	94
7800DZ-1.5/16	7314150166077	10	94
7800DZ-1.7/16	7314150464609	1	94
7800DZ-1/2	7314151097455	10	94
7800DZ-11/16	7314151097493	10	94
7800DZ-11/32	7314150465712	10	94
7800DZ-13/16	7314151097523	10	94
7800DZ-13/32	7314150464623	10	94
7800DZ-15/16	7314151097554	10	94
7800DZ-19/32	7314151097479	10	94
7800DZ-25/32	7314151097516	10	94
7800DZ-3/4	7314151097509	10	94
7800DZ-3/8	7314151097431	10	94
7800DZ-5/16	7314150464647	10	94
7800DZ-5/8	7314151097486	10	94
7800DZ-7/16	7314151097448	10	94
7800DZ-7/8	7314151097530	10	94
7800DZ-9/16	7314151097462	10	94
7800SM-10	7314151097851	10	92
7800SM-11	7314151097868	10	92
7800SM-12	7314151097875	10	92
7800SM-13	7314151097882	10	92
7800SM-14	7314151097899	10	92
7800SM-15	7314151097905	10	93
7800SM-16	7314151097912	10	93
7800SM-17	7314151097929	10	93
7800SM-18	7314151097936	10	93
7800SM-19	7314151097943	10	93
7800SM-20	7314150166206	10	93



7800SM-21	7314151097967	10	93
7800SM-22	7314151097974	10	93
7800SM-23	7314151097981	10	93
7800SM-24	7314151097998	10	93
7800SM-25	7314151098001	10	93
7800SM-26	7314151830823	10	93
7800SM-27	7314151098025	10	93
7800SM-28	7314151830830	10	93
7800SM-29	7314150166213	10	93
7800SM-30	7314151098056	10	93
7800SM-32	7314151098063	10	93
7800SM-33	7314150167319	10	93
7800SM-34	7314153011305	10	93
7800SM-36	7314151098087	10	93
7800SM-8	7314151830793	10	92
7800SM-9	7314151830809	10	92
7800TORX-E10	7314150166084	1	94
7800TORX-E11	7314150220359	1	94
7800TORX-E12	7314153011800	1	94
7800TORX-E14	7314153011756	1	94
7800TORX-E16	7314153011763	1	94
7800TORX-E18	7314153011770	1	94
7800TORX-E20	7314153011787	1	94
7800TORX-E24	7314153011794	1	94
7800TORX-E8	7314150166091	1	94
7800TORX/9	7314150469741	1	97
7805DM-10	7314151822101	10	94
7805DM-12	7314151098452	10	94
7805DM-13	7314151098469	10	94
7805DM-14	7314151098476	10	94
7805DM-15	7314151098483	10	94
7805DM-16	7314151098490	10	94
7805DM-17	7314151098506	10	94
7805DM-18	7314151098513	10	94
7805DM-19	7314151098520	10	94
7805DM-21	7314151098544	10	94
7805DM-22	7314151098551	10	94
7805DM-23	7314150313532	10	94
7805DM-24	7314151098568	10	94
7805DM-26	7314151098582	10	94
7805DM-27	7314151098599	10	94
7805DM-30	7314151098605	10	94
7805DM-32	7314150220281	10	94
7805DM-34	7314150488537	10	94
7805DZ-1	7314150357758	10	94
7805DZ-1.1/16	7314150357765	10	94
7805DZ-1.1/2	7314150357833	10	94
7805DZ-1.1/4	7314150357796	10	94
7805DZ-1.1/8	7314150357772	10	94
7805DZ-1.3/16	7314150357789	10	94
7805DZ-1.3/8	7314150357819	10	94
7805DZ-1.5/16	7314150357802	10	94
7805DZ-1.7/16	7314150357826	10	94
7805DZ-11/16	7314150357703	10	94
7805DZ-13/16	7314150357727	10	94
7805DZ-15/16	7314150357741	10	94
7805DZ-3/4	7314150357710	10	94
7805DZ-5/8	7314150357697	10	94
7805DZ-7/8	7314150357734	10	94
7805GPR-16	7314150503117	120	307
7805GPR-21	7314150503124	100	307
7805SM-10	7314153011312	10	93
7805SM-11	7314150475926	10	93
7805SM-12	7314153011329	10	93
7805SM-13	7314153011336	10	93
7805SM-14	7314153011343	10	93
7805SM-15	7314153011350	10	93
7805SM-16	7314153011367	10	93
7805SM-17	7314153011374	10	93
7805SM-18	7314153011381	10	93
7805SM-19	7314153011398	10	93
7805SM-20	7314153011404	10	93
7805SM-21	7314153011411	10	93
7805SM-22	7314153011428	10	93
7805SM-23	7314153011435	10	93
7805SM-24	7314153011442	10	93
7805SM-25	7314153011459	10	93
7805SM-26	7314153011466	10	93
7805SM-27	7314153011473	10	93
7805SM-28	7314153011480	10	93
7805SM-29	7314153011497	10	93
7805SM-30	7314153011503	10	93
7805SM-32	7314153011527	10	93
7805SM-34	7314153024251	10	93
7805SZ-1.1/2	7314150357987	1	93
7805SZ-1.1/4	7314150357949	1	93
7805SZ-1.3/16	7314150357932	1	93
7805SZ-1.3/8	7314150357963	1	93
7805SZ-1.5/16	7314150357956	1	93
7805SZ-1.7/16	7314150357970	1	93
7806MD	7314150220335	1	77
7807	7314153012029	1	306
7807H	7314151232764	1	177
7807TE	7314150313792	1	78
7808H	7314151232771	1	177
7808HM	7314150220434	1	98



7809F-10	7314151830892	5	97
7809F-8	7314151830885	5	97
7809H	7314151232788	1	177
7809HL	7314150128464	1	96
7809M-10	7314151815608	1	97
7809M-10-140	7314151831011	1	98
7809M-12	7314151815615	1	97
7809M-14	7314151815622	1	97
7809M-17	7314151831028	1	97
7809M-19	7314151831035	1	97
7809M-4	7314150214600	10	97
7809M-5	7314151815561	1	97
7809M-5-100	7314150313761	1	98
7809M-5-180	7314151830922	1	98
7809M-6	7314151815578	1	97
7809M-6-100	7314150313778	1	98
7809M-6-140	7314151830946	1	98
7809M-7	7314151815585	1	97
7809M-7-100	7314151830960	1	98
7809M-8	7314151815592	1	97
7809M-8-120	7314151830984	1	98
7809M-9	7314151830991	1	97
7809M/10	7314151831448	1	73
7809PH-2	7314151830908	1	97
7809PH-3	7314151830915	1	97
7809PH-4	7314153003423	1	97
7809PZ-2	7314153003430	1	97
7809PZ-3	7314153003447	1	97
7809TO	7314150220465	1	97
7809TORX-T20	7314151811730	1	97
7809TORX-T25	7314151811747	1	97
7809TORX-T27	7314151811754	1	97
7809TORX-T30	7314151811761	1	97
7809TORX-T40	7314151811778	1	97
7809TORX-T40-120	7314150220564	5	97
7809TORX-T45	7314151811785	1	97
7809TORX-T45-120	7314150220557	1	97
7809TORX-T50	7314151811792	1	97
7809TORX-T50-100	7314150220540	1	97
7809TORX-T55	7314151811808	1	97
7809TORX-T55-140	7314150220533	5	97
7809TORX-T60	7314151811815	1	97
7809TORX-T70-140	7314150220526	5	97
7809TORX/10	7314151831455	1	74
7809XZN-10	7314151831080	1	98
7809XZN-10-100	7314151831097	1	98
7809XZN-12	7314151831103	1	98
7809XZN-12-100	7314151831110	1	98
7809XZN-14	7314153004574	1	98
7809XZN-14-100	7314153004567	1	98
7809XZN-16	7314150220458	1	98
7809XZN-18	7314150314058	1	98
7809XZN-6	7314150214617	1	98
7809XZN-8	7314151831066	1	98
7809XZN-8-100	7314151831073	1	98
7809Z-1/2	7314153003515	1	98
7809Z-1/4	7314153003478	1	98
7809Z-17/32	7314150313785	1	98
7809Z-19/32	7314153003546	1	98
7809Z-3/16	7314153003461	1	98
7809Z-3/8	7314153003492	1	98
7809Z-5/16	7314153003485	1	98
7809Z-5/8	7314153003553	1	98
7809Z-7/16	7314153003508	1	98
7809Z-9/16	7314153003539	1	98
7809Z/10	7314153003560	1	74
7810MB	7314150220380	1	77
7810MH	7314150220373	1	77
7811DMV	7314150122134	1	514
7812	7314150502028	100	319
7814DS	7314150318964	1	74
7814DST	7314150319022	1	76
7817DZS	7314150319008	1	76
7817DZS1	7314150389902	1	76
7818DS	7314150318971	1	74
7818DST	7314150319039	1	76
7818MHR	7314150218912	1	74
7818SST	7314150319046	1	76
7819DRN	7314151831547	1	75
7819SRE	7314151837921	1	74
782-J	7311518276447	1	309
7823	7314150218141	16	170
7823DET	7314150319084	1	77
7823DZS	7314150319015	1	76
7823SE	7314150318988	1	75
7825DST	7314150319060	1	77
7825MBP	7314150218929	1	75
7825MHP	7314150218943	1	74
7825SST	7314150319053	1	77
7827DST	7314150319077	1	77
783	7311518276034	1	327
7835 G-160	7314150050253	5	245
7847SS	7314150318995	1	75
7851-G	7314150124909	1	117
7851-M	7314150124893	1	117
7865	7311518276720	1	170



787-1.1/16	7314150363186	1	51
787-1.1/2	7314150363254	1	51
787-1.1/4	7314150363216	1	51
787-1.1/8	7314150363193	1	51
787-1.11/16	7314150363278	1	51
787-1.13/16	7314150363292	1	51
787-1.3/16	7314150363209	1	51
787-1.3/4	7314150363285	1	51
787-1.3/8	7314150363230	1	51
787-1.5/16	7314150363223	1	51
787-1.5/8	7314150363261	1	51
787-1.7/16	7314150363247	1	51
787-1.7/8	7314150363308	1	51
787-2	7314150363315	1	51
787-2.1/4	7314150363346	1	51
787-2.1/8	7314150363322	1	51
787-2.3/16	7314150363339	1	51
787-2.3/8	7314150363353	1	51
7888DM	7314151820923	1	75
789-1.1/2	7314150363896	1	54
789-1.1/4	7314150363858	1	54
789-1.1/8	7314150363841	1	54
789-1.13/16	7314150363933	1	54
789-1.3/4	7314150363926	1	54
789-1.3/8	7314150363872	1	54
789-1.5/16	7314150363865	1	54
789-1.5/8	7314150363919	1	54
789-1.7/16	7314150363889	1	54
789-1.9/16	7314150363902	1	54
789-2	7314150363940	1	54
789-2.1/4	7314150363957	1	54
789-2.3/8	7314150363971	1	54
789-2.5/16	7314150363964	1	54
789-28	7314150363742	1	54
789-30	7314150363759	1	54
789-32	7314150357673	1	54
789-34	7314150363766	1	54
789-36	7314150363773	1	54
789-38	7314150363780	1	54
789-40	7314150363797	1	54
789-41	7314150363803	1	54
789-42	7314150363810	1	54
789-46	7314150363827	1	54
789-50	7314150363834	1	54
790450A	7314150214716	1	264
790455A	7314150214709	1	264
7993M0170	8413345115353	1	182
7993M0190	8413345115377	1	182
7993M0220	8413345115391	1	182
7993M0270	8413345115414	1	182
7993S0050	8413345115070	1	177
7993S0060	8413345115094	1	177
7993S0080	8413345115117	1	177
7993S0100	8413345115131	1	177
7993S0120	8413345115155	1	177
7993S0140	8413345115179	1	177
7993S0170	8413345115193	1	177
7993S0180	7314150476855	1	177
7993S0190	8413345115216	1	177
7993T0120	8413345115230	1	180
7993T0140	8413345115254	1	180
7993T0170	8413345115278	1	180
7993T0190	8413345115292	1	180
7993T0220	8413345115315	1	180
7993T0240	8413345115339	1	180
7994S0200	7314150492954	1	177
7994S0250	7314150492947	1	177
7994S0270	7314150492930	1	177
7994S0300	8413345129305	1	177
7994S0400	8413345129312	1	177
7994S0450	8413345129329	1	177
7994S0500	8413345129336	1	177
7994S0550	8413345129343	1	177
7994S0600	8413345129350	1	177
8010SL-2P	7314150243853	1	508
8020-2P	7314150246601	1	195
8030-2P	7314150246618	1	195
8040-2P	7314150246625	1	195
8040L-2P	7314150246670	1	196
8040SL-2P	7314150243877	1	508
8045LVDE	7314151509163	10	218
8045VDE	7314151317256	10	218
8050SL-2P	7314150243884	1	508
8052	7314151318406	5	217
806-1-1	7311518003760	6	218
806-1-2	7314150183258	6	218
806-1-3	7314150183265	6	218
8060B0080	8413345018104	1	267
8060B0100	8413345018111	1	267
8060B0120	8413345018128	1	267
8060B0140	8413345018135	1	267
8060B0180	8413345018142	1	267
8060B0240	8413345018159	1	267
8060B0360	8413345018166	1	267
8060T0080	8413345018173	1	267
8060T0100	8413345018180	1	267



8060T0140



8060T0140	8413345018203	1	267
8060T0180	8413345018210	1	267
8060T0240	8413345018227	1	267
8060T0360	8413345018234	1	267
8069	7314150007028	5	39
8069 C	7314150007035	5	39
8069 C IP	7314150101634	5	39
8069 IP	7314150007042	50	39
8069-1	7314150239511	1	39
8069-2	7314150238590	1	39
8070	7314150007110	5	39
8070 C	7314150007127	5	39
8070 C IP	7314150101641	5	39
8070 IP	7314150007134	40	39
8070-1	7314150239528	1	39
8070-2	7314150238606	1	39
8070V	7314150121519	2	511
8070VL	7314150213511	1	511
8071	7314150007202	5	39
8071 C	7314150007219	5	39
8071 C IP	7314150101658	5	39
8071 IP	7314150007226	50	39
8071-1	7314150239535	1	39
8071-2	7314150238613	1	39
8071V	7314150121526	2	511
8071VL	7314150213535	1	511
8071VLT	7314150121564	1	511
8072	7314150007288	5	39
8072 C	7314150007295	5	39
8072 C IP	7314150101665	5	39
8072 IP	7314150007301	30	39
8072-1	7314150239542	1	39
8072-2	7314150238620	1	39
8072V	7314150121533	2	511
8072VL	7314150213542	1	511
8072VLT	7314150121571	1	511
8073	7314150007363	5	39
8073 C	7314150007370	5	39
8073 C IP	7314150101672	5	39
8073 IP	7314150007387	20	39
8073-1	7314150239559	1	39
8073-2	7314150238637	1	39
8073V	7314150121540	2	511
8073VL	7314150213559	1	511
8073VLT	7314150121588	1	511
8074	7314150007448	3	39
8074 C	7314150007455	3	39
8074 C IP	7314150101689	3	39
8074 IP	7314150007462	20	39
8074-1	7314150239566	1	39
8074-2	7314150238644	1	39
8074V	7314150121557	2	511
8075	7314150007523	3	39
8075 C	7314150007530	3	39
8075 C IP	7314150101696	3	39
8075 IP	7314150007547	10	39
8075-1	7314150239573	1	39
8075-2	7314150238651	1	39
808050	7314153017642	50	210
808050A	7314150127306	1	216
808050L	7314150128075	25	210
808050L-SP1	7314150129218	1	210
808050P	7314150128105	50	210
808050P-25	7314150165179	10	211
808050S	7314150128082	25	211
808050S-18	7314150128921	30	211
808050S-22	7314150128938	30	211
808050TORX	7314150127313	50	216
808050TS	7314150128099	1	211
808060	7314150243822	1	508
808061	7314150243839	5	508
808062	7314150243846	5	508
8100B0140	7314150263028	1	267
8100B0240	8413345018296	1	267
8100B0360	8413345099660	1	267
8100F0180	7314150263059	1	267
8100F0240	7314150263066	1	267
8100F0360	8413345135849	1	267
8100T0100	7314150263073	1	267
8100T0140	8413345018333	1	267
8100T0180	7314150263080	1	267
8100T0240	7314150263097	1	267
8100T0360	7314150263103	1	267
8110H-1/2	7314153015860	1	99
8120-1/2	7314150384884	12	99
8120-1/4	7314150384921	20	86
8120-3/8	7314150384914	10	90
8150-1/2	7314151105006	1	98
8150-1/2-SPARE	7314150187881	1	100
8150-1/2V	7314150121601	1	512
8150RN-1/2	7314151831202	1	98
8150RN-1/2-SPARE	7314150209378	1	100
8150SL	7314150197682	1	98
8150SL-SPARE	7314150210275	1	100
8151-1/2	7314151105112	1	99
8152-1/2	7314151105129	1	94



8154-1/2V	7314150121595	1	512
8154-11	7314150469161	10	95
8155-1/2	7314151827595	1	98
8155-SO/1	7314153000811	1	99
8156-1/2	7314150166053	1	94
8157-10	7314150467273	1	94
8157-15	7314150469222	1	94
8157-24	7314150469246	1	94
8157-36	7314150469260	1	94
8158-10	7314150471003	1	95
8158-15	7314150471010	1	95
8160-1/2V	7314150121618	1	513
8160-10	7314150469185	10	95
8160-3	7314150469208	10	95
8160-5	7314150469284	10	95
8160-B	7314150182565	1	95
8160W-10	7314150471027	10	95
8160W-3	7314150471041	10	95
8160W-5	7314150471065	10	95
8162-1/2V	7314150121625	1	513
8164-1/2	7314151105266	1	89
8166	7314150459377	10	95
8167	7314153003584	1	89
8167-1/2	7314150181094	1	95
8168	7314150128440	1	95
8171	7314150469307	10	96
8172	7314150469321	10	96
8174A	7314150476374	10	96
8194-1/2	7314151831226	1	99
8195-KEY	7314150389810	50	96
8195-R	7314150389780	1	99
8195-SET	7314150389797	5	99
8195-SQ	7314150389803	25	99
8220SL-2P	7314150243860	1	508
8223	7314150112685	4	247
8223 IP	7314150113149	4	247
8224	7314150000012	4	247
8224 IP	7314150101757	4	247
8224CIP	7314150103607	4	247
8225	7314150000029	4	247
8225 IP	7314150101764	4	247
8225CIP	7314150103614	4	247
8226	7314150115853	1	247
8231	7311518266509	4	247
8231 IP	7311518270285	4	247
8242-2P	7314150243686	1	195
8242L-2P	7314150246687	1	196
8252-2P	7314150243693	1	195
8252L-2P	7314150246694	1	196
8252XL-1P	7314150265985	1	197
833AJ-4	7311518286927	1	604
833AJ-5	7311518286934	1	604
833AJ-6	7311518286941	1	604
833FJ-4	7311518286965	1	604
833FJ-5	7311518286972	1	604
833FJ-6	7311518286989	1	604
833PJ-4	7311518286897	1	603
833PJ-5	7311518286903	1	603
833PJ-67	7311518286910	1	603
833SB-4	7311518286859	1	604
833SB-5	7311518286866	1	604
833SB-6	7311518286873	1	604
833SB-7	7311518286880	1	604
834V-2	7314150124992	1	603
834V-4	7311518286811	1	603
834V-5	7311518286828	1	603
834V-6	7311518286835	1	603
834V-7	7311518286842	1	603
84-PODGER	7314150307494	1	40
850-1	7311518292737	10	562
8501-10	7311518004828	1	141
8501-10F	7311518220945	1	141
8501-12	7311518004842	1	141
8501-12F	7311518220952	1	141
8501-13	7311518004859	1	141
8501-136-10-24C	7314150371471	1	141
8501-136-20-24C	7314150371488	1	141
8501-13F	7311518220969	1	141
8501-15	7311518004873	1	141
8501-150-10-24C	7314150403004	1	141
8501-15F	7311518220976	1	141
8501-16	7311518004880	1	141
8501-160-20-24C	7314150403011	1	141
8501-160-20-48XF	7314150402892	1	141
8501-165-20-24C	7314150403028	1	141
8501-165-20-48XF	7314150402908	1	141
8501-16F	7311518220983	1	141
8501-16SW	7314150258642	1	141
8501-17	7311518004897	1	141
8501-17F	7311518220990	1	141
8501-17S	7311518221027	1	142
8501-184-16-24	7314150402946	1	141
8501-184-16-40	7314150402953	1	141
8501-184-20-24C	7314150403042	1	141
8501-18S	7311518221034	1	142
8501-18SW	7311518221058	1	141



8501-190-30-24C	7314150403059	1	141
8501-190-30-60XF	7314150402960	1	141
8501-2	7311518004743	1	141
8501-210-30-48SW	7314150403066	1	141
8501-210-30-60XF	7314150402977	1	141
8501-216-60SW	7314150359448	1	141
8501-22	7311518178888	1	141
8501-22F	7311518221003	1	141
8501-23	7311518004958	1	141
8501-230-30-60XF	7314150402984	1	141
8501-235-30-60XF	7314150402991	1	141
8501-23F	7311518018887	1	141
8501-260-24SW	7314150359479	1	141
8501-260-30-80S	7314150403097	1	142
8501-260-40SW	7314150359462	1	141
8501-260-60SW	7314150359455	1	141
8501-28	7311518018894	1	141
8501-28F	7311518221010	1	141
8501-28S	7311518221041	1	142
8501-28SW	7311518221065	1	141
8501-28XF	7311518281946	1	141
8501-3	7311518004750	1	141
8501-30	7311518237479	1	141
8501-305-30-40SW	7314150403073	1	141
8501-305-30-60SW	7314150403080	1	141
8501-305-30-96S	7314150403103	1	142
8501-30F	7311518237462	1	141
8501-30S	7311518282240	1	142
8501-30SW	7311518282196	1	141
8501-30XF	7311518281984	1	141
8501-31	7311518237455	1	141
8501-31F	7311518237448	1	141
8501-4	7311518008079	1	141
8501-40	7311518282042	1	141
8501-4F	7311518220914	1	141
8501-4XF	7311518281786	1	141
8501-5	7311518004774	1	141
8501-5F	7311518220921	1	141
8501-7	7311518004798	1	141
8501-7F	7311518220938	1	141
8510SL-2P	7314150245758	1	508
8520SL-2P	7314150245765	1	508
86	7314150005376	1	39
86-1	7314150254996	1	39
86-2	7314150255009	1	39
8600-2P	7314150245654	1	195
8610-2P	7314150243648	1	195
8610L-2P	7314150246700	1	196
8610SL-2P	7314150243891	1	508
8620-2P	7314150243662	1	195
8620L-2P	7314150246717	1	196
8620SL-2P	7314150243907	1	508
8620XL-1P	7314150265947	1	197
8630-2P	7314150246571	1	195
8630XL-1P	7314150265961	1	197
864000010	8413345137638	1	567
864000020	7314150330171	1	567
864002450	8413345129022	50	567
864100010	8413345137621	1	567
864102400	8413345129015	1	567
865-1	7311518292744	10	562
869102500	8413345083669	6	592
869103000	8413345116640	6	592
869203000	8413345137508	6	592
87	7314150005406	3	39
87-1	7314150255016	1	39
87-2	7314150255023	1	39
8703-2P	7314150246632	1	196
8704-2P	7314150246649	1	196
8705-2P	7314150246656	1	196
8706-2P	7314150246663	1	196
8710SL-2P	7314150245772	1	508
8720SL-2P	7314150245789	1	508
874002000	8413345024938	5	619
874002500	8413345024945	5	619
874003000	8413345024952	5	619
874003500	8413345024969	5	619
874004000	8413345024976	5	619
874005000	8413345024983	5	619
874102000	8413345080989	6	619
874102500	8413345081009	5	619
874103000	8413345081023	5	619
874103500	8413345081047	4	619
874104000	8413345081061	5	619
874602000	8413345024990	5	619
874602500	8413345025003	5	619
874603000	8413345025065	5	619
874603500	8413345025072	5	619
874604000	8413345025089	5	619
874916X16	7314150489787	1	620
874918X18	7314150489800	1	620
874923X13	7314150489763	1	620
874926X7	7314150489749	1	620
876002000	8413345025119	10	620
876002500	8413345025126	5	620
877002400	8413345025140	25	620



8800-2P	7314150246588	1	195
8810-2P	7314150243655	1	195
8810L-2P	7314150246724	1	196
8810SL-2P	7314150243914	1	508
8820-2P	7314150243679	1	195
8820L-2P	7314150246731	1	196
8820SL-2P	7314150243921	1	508
8820XL-1P	7314150265954	1	197
8821MB	7314150220571	1	78
8830-2P	7314150246595	1	195
8830XL-1P	7314150265978	1	197
8840M	7314151105495	1	79
8845DM	7314151105525	1	78
8845NM	7314151810955	1	78
8900DM-19	7314151105730	1	100
8900DM-21	7314150166367	5	100
8900DM-22	7314151105754	1	100
8900DM-23	7314150166374	1	100
8900DM-24	7314151105778	1	100
8900DM-25	7314151105785	1	100
8900DM-26	7314150219797	1	100
8900DM-27	7314151105822	1	100
8900DM-28	7314151105846	1	100
8900DM-29	7314150219803	1	100
8900DM-30	7314151105884	5	100
8900DM-32	7314151105891	1	100
8900DM-33	7314150166398	1	100
8900DM-34	7314151838478	1	100
8900DM-35	7314150219810	1	100
8900DM-36	7314151105914	1	100
8900DM-37	7314150166404	1	100
8900DM-38	7314150219827	1	100
8900DM-40	7314150166411	1	100
8900DM-41	7314151105938	5	100
8900DM-42	7314150166428	1	100
8900DM-46	7314151105952	1	100
8900DM-47	7314150166435	1	100
8900DM-50	7314151105969	5	100
8900DM-52	7314150166442	1	100
8900DM-54	7314150166459	3	100
8900DM-55	7314151105983	1	100
8900DM-56	7314150166466	1	100
8900DM-60	7314151106003	5	100
8900DZ-1	7314151106058	1	100
8900DZ-1.1/16	7314151106065	1	100
8900DZ-1.1/2	7314151106133	1	101
8900DZ-1.1/4	7314151106096	1	101
8900DZ-1.1/8	7314151106072	1	100
8900DZ-1.11/16	7314150166282	1	101
8900DZ-1.13/16	7314151106188	1	101
8900DZ-1.3/16	7314151106089	1	100
8900DZ-1.3/4	7314151106171	1	101
8900DZ-1.3/8	7314151106119	1	101
8900DZ-1.5/16	7314151106102	5	101
8900DZ-1.5/8	7314151106157	1	101
8900DZ-1.7/16	7314151106126	1	101
8900DZ-1.7/8	7314151106195	1	101
8900DZ-1.9/16	7314150166299	1	101
8900DZ-13/16	7314150166305	1	100
8900DZ-15/16	7314151106034	1	100
8900DZ-2	7314151106201	1	101
8900DZ-2.1/16	7314150166312	1	101
8900DZ-2.1/4	7314150166329	1	100
8900DZ-2.1/8	7314150166336	1	101
8900DZ-2.3/16	7314150358670	1	101
8900DZ-2.3/8	7314150166350	5	101
8900DZ-3/4	7314150166381	1	100
8900DZ-31/32	7314150358663	1	100
8900DZ-7/8	7314150166473	1	100
8900SM-19	7314150166633	1	100
8900SM-22	7314151810795	1	100
8900SM-23	7314150219834	1	100
8900SM-24	7314151810801	5	100
8900SM-26	7314150219841	5	100
8900SM-27	7314151810818	5	100
8900SM-28	7314150166657	1	100
8900SM-29	7314150219858	1	100
8900SM-30	7314151810825	5	100
8900SM-32	7314151810832	5	100
8900SM-33	7314150166671	1	100
8900SM-34	7314151838461	1	100
8900SM-35	7314150166688	1	100
8900SM-36	7314151810849	5	100
8900SM-38	7314151810856	1	100
8900SM-41	7314151810863	5	100
8900SM-42	7314150219865	1	100
8900SM-46	7314151810870	1	100
8900SM-50	7314151810887	1	100
8900SM-55	7314151810894	1	100
8900SM-60	7314151810900	1	100
8900SZ-1	7314150166480	1	100
8900SZ-1.1/16	7314150166497	1	100
8900SZ-1.13/16	7314150166534	1	100
8900SZ-1.3/4	7314150166541	1	100
8900SZ-1.3/8	7314150166558	1	100
8900SZ-1.5/16	7314150166565	1	100



8900SZ-1.5/8



8900SZ-1.5/8	7314150166572	1	100
8900SZ-1.7/16	7314150166589	1	100
8900SZ-1.7/8	7314150166596	1	100
8900SZ-1.9/16	7314150166602	1	100
8900SZ-13/16	7314150166619	1	100
8900SZ-2	7314150166640	1	100
8900SZ-3/4	7314150166664	1	100
8900SZ-7/8	7314150166695	1	100
89049TM-1000	7314150415403	1	115
8905-TM	7314150125470	1	115
8910-2P	7314150243709	1	196
8910SL-2P	7314150243938	1	508
8915-2P	7314150243716	1	196
8915L-2P	7314150258765	1	196
8915SL-2P	7314150243945	1	508
8920-2P	7314150243723	1	196
8920L-2P	7314150258772	1	196
8920SL-2P	7314150243952	1	508
89222CCR-1000	7314150415441	1	116
8925-2P	7314150243730	1	196
8925L-2P	7314150258789	1	196
8925SL-2P	7314150243969	1	508
8927-2P	7314150243747	1	196
8927L-2P	7314150263516	1	196
8930-2P	7314150243754	1	196
8930L-2P	7314150258796	1	196
8930SL-2P	7314150243976	1	508
8940-2P	7314150243761	1	196
894M-10	7314151833039	10	51
894M-100	7314151833305	1	51
894M-105	7314151833312	1	51
894M-11	7314151833046	10	51
894M-110	7314151833329	1	51
894M-115	7314151833336	1	51
894M-12	7314151833053	10	51
894M-120	7314151833343	1	51
894M-125	7314150132478	1	51
894M-13	7314151833060	10	51
894M-130	7314150132485	1	51
894M-135	7314150132492	1	51
894M-14	7314151833077	10	51
894M-15	7314151833084	10	51
894M-16	7314150139569	10	51
894M-17	7314151833091	10	51
894M-19	7314151833107	10	51
894M-21	7314150223220	5	51
894M-22	7314151833114	5	51
894M-24	7314151833121	5	51
894M-27	7314151833138	5	51
894M-30	7314151833145	5	51
894M-32	7314151833152	5	51
894M-34	7314150139583	1	51
894M-36	7314151833169	5	51
894M-38	7314151833176	1	51
894M-41	7314151833183	1	51
894M-46	7314151833190	1	51
894M-50	7314151833206	1	51
894M-55	7314151833213	1	51
894M-60	7314151833220	1	51
894M-65	7314151833237	1	51
894M-7	7314151833008	10	51
894M-70	7314151833244	1	51
894M-75	7314151833251	1	51
894M-8	7314151833015	10	51
894M-80	7314151833268	1	51
894M-85	7314151833275	1	51
894M-9	7314151833022	10	51
894M-90	7314151833282	1	51
894M-95	7314151833299	1	51
8950N/A	7314151810948	1	102
8950NA-SO/2	7314151816605	1	102
8951	7314151106782	1	102
8951-M	7314150124916	1	117
8953	7314151106799	1	101
8954	7314151106805	1	101
8954A	7314151106812	1	101
8955N	7314150434114	1	102
8955N-SPARE	7314150434121	1	102
8955N/A	7314150434053	1	102
8955N/B	7314150434176	5	102
8958	7314151106829	1	101
8958A	7314151106836	1	101
895M-10-11	7314151832742	10	49
895M-10-13	7314151832759	10	49
895M-13-17	7314151832803	10	49
895M-17-19	7314151832827	10	49
895M-19-22	7314151832834	10	49
895M-19-24	7314151832841	5	49
895M-22-24	7314151832858	5	49
895M-24-27	7314151832865	5	49
895M-24-30	7314151832872	5	49
895M-27-32	7314151832889	5	49
895M-30-32	7314151832896	5	49
895M-30-36	7314151832902	1	49
895M-32-36	7314151832919	1	49
895M-36-41	7314151832926	1	49



895M-41-46	7314151832933	1	49
895M-46-50	7314151832940	1	49
895M-50-55	7314151832957	1	49
895M-55-60	7314151832964	1	49
895M-6-7	7314151832711	10	49
895M-65-70	7314151832971	1	49
895M-8-10	7314151832735	10	49
895M-8-9	7314151832728	10	49
8961	7314151106850	1	101
8962	7314151106867	1	101
8963	7314150181087	1	101
8965	7314151106881	1	101
8966	7314151106898	1	101
8967	7314153003591	1	96
8967/S3	7314153003607	1	83
9-12-51/3806-KP	7311518044558	5	648
9-462-14-0-0	7311518020873	5	35
9-463-14-0-0	7311518327750	1	35
9-467-00-0-0	7311518020897	1	35
9-469-00-0-0	7311518020903	1	35
9-484-3.2-10	7311518193348	10	35
9-484-3.2-1P	7311518193522	10	35
9-484-5.2-10	7311518193355	10	35
9-484-5.2-1P	7311518193331	10	35
9-485-04-10	7314150271672	10	36
9-485-04-1P	7314150271665	10	36
9-485-05-10	7314150271696	10	36
9-485-05-1P	7314150271689	10	36
9-485-06-10	7311518193508	10	36
9-485-06-1P	7311518193492	20	36
9-485-09-10	7311518193386	10	36
9-485-09-1P	7311518193362	20	36
9-485-13-10	7311518193393	10	36
9-485-13-1P	7311518193379	1	36
9-486-04-10	7311518193430	10	36
9-486-04-1P	7311518193409	20	36
9-486-05-10	7311518193461	10	36
9-486-05-1P	7311518193447	20	36
9-486-07-10	7311518249373	10	36
9-486-07-1P	7311518249359	20	36
9-486-08-10	7311518270933	10	36
9-486-C-10	7311518209599	10	36
9-486-C-1P	7311518209605	10	36
9-488-02-10	7311518194772	10	35
900T-020-100	7314153018106	5	214
900T-025-100	7314153018113	5	214
900T-030-100	7314153018120	5	214
900T-040-150	7314153018137	5	214
900T-050-150	7314153018144	5	215
900T-060-200	7314153018151	5	215
900T-080-200	7314153018168	5	215
900T-100-200	7314153018175	5	215
901T-006-100	7314153018182	5	215
901T-007-100	7314153018199	5	215
901T-008-100	7314153018205	5	215
901T-009-100	7314153018212	5	215
901T-010-100	7314153018229	5	215
901T-015-150	7314153018236	5	215
901T-020-150	7314153018243	5	215
901T-025-150	7314153018250	5	215
901T-027-150	7314153018267	5	215
901T-030-200	7314153018274	5	215
901T-040-200	7314153018281	5	215
901T-045-200	7314153018298	5	215
901T-050-200	7314153018304	5	215
9029	7314153010612	5	38
9029 C	7314153010629	5	38
9029-1	7314150239580	1	39
9029-2	7314150238668	1	39
9029-T	7314150189076	5	38
9029T-1	7314150312139	1	39
902T-050-150	7314153018311	5	215
902T-055-150	7314153018328	5	215
902T-060-150	7314153018335	5	215
902T-070-175	7314153018342	5	215
902T-080-175	7314153018359	5	215
902T-090-175	7314153018366	5	215
902T-100-175	7314153018373	5	215
902T-110-175	7314153018380	5	215
902T-120-175	7314153018397	5	215
902T-130-175	7314153018403	5	215
9031	7314150110988	5	38
9031 C	7314150113507	5	38
9031 P-1	7314150266302	1	39
9031-1	7314150239597	1	39
9031-8224	7314150321193	3	258
9031-T	7314150131648	5	38
9031P	7314150187539	5	38
9031T-1	7314150312146	1	39
9033	7314150181414	5	38
9033-1	7314150353804	1	39
9035	7314150181421	5	38
9035-1	7314150353811	1	39
903T-1	7314153018410	1	215
903T-2	7314153018427	1	215
903T-3	7314153018434	1	216



9045-B-200	7311518012175	6	558
9045-B-250	7311518012182	6	558
9045-B-300	7311518012199	6	558
9045-B-400	7311518178123	1	558
9048-200	7314150138159	10	558
9048-250	7314150138166	10	558
9048-300	7314150138173	10	558
9048-350	7314150180349	10	558
9048-400	7314150138180	10	558
904T-060-150	7314153019837	5	216
905T-060-100	7314153019844	5	215
9070	7314150100170	5	38
9070 P	7314150103416	5	38
9070 P-1	7314150239610	1	39
9070 PC	7314150103423	5	38
9070C	7314150100187	5	38
9071	7314150100194	5	38
9071 P	7314150103430	5	38
9071 P-1	7314150239627	1	39
9071 PC	7314150103447	5	38
9071C	7314150100200	5	38
9072	7314150055609	5	38
9072 C	7314150055616	5	38
9072 P	7314150056354	5	38
9072 P-1	7314150239634	1	39
9072 PC	7314150056361	5	38
9073	7314150101702	5	38
9073 C	7314150101719	3	38
9073 P	7314150101726	5	38
9073 P-1	7314150239641	1	39
9073 PC	7314150101733	3	38
91-023-5P	7311518032593	1	138
91-027-5P	7311518032616	1	138
91-143-100P	7311518224363	1	138
91-143-25P	7311518266578	1	138
91-143-5P	7311518032630	1	138
91-148-5P	7311518032654	1	138
91-223-5P	7311518032661	1	138
91-226-5P	7311518032685	1	138
91-233-5P	7311518260057	1	138
91-243-5P	7311518032692	1	138
91-2PW-5P	7311518260163	1	138
91-3PM-5P	7311518260156	1	138
91-412-5P	7311518260040	1	138
91-433-5P	7311518260101	1	138
91-434-5P	7311518260026	1	138
91-443-5P	7311518032722	1	138
91-444-5P	7311518260033	1	138
91-4PWM-5P	7311518260170	1	138
91-502-5P	7311518032746	1	138
91-512-25P	7311518266592	1	138
91-512-5P	7311518032753	1	138
91-517-5P	7311518032777	1	138
91-522-5P	7311518032784	1	138
91-611-5P	7311518260071	1	138
91-612-5P	7311518032814	1	138
91-622-5P	7311518260088	1	138
91-623-5P	7311518260064	1	138
91-7V1-5P	7311518260118	1	138
91-METAL-10P	7314150449477	1	138
91-MIXED-10P	7314150449491	1	138
91-WOOD-10P	7314150449446	1	138
91C	7314150182381	5	40
92-001-1P	7314150474998	90	140
92-106-1P	7314150474899	90	139
92-113-1P	7314150474912	90	140
92-118-1P	7314150474950	90	140
92-133-1P	7314150474134	70	139
92-133-25	7314150486687	25	139
92-133-3P	7314150474158	46	139
92-136-1P	7314150474783	20	141
92-136-G120-5P	7314150498079	10	141
92-136-G240-5P	7314150498116	10	141
92-136-G40-5P	7314150497997	10	141
92-136-G80-5P	7314150498031	10	141
92-137-1P	7314150475070	50	141
92-137-G120-5P	7314150498093	10	141
92-137-G240-5P	7314150498130	10	141
92-137-G40-5P	7314150498017	10	141
92-137-G80-5P	7314150498055	10	141
92-157-1P	7314150474820	70	139
92-157-25	7314150486816	25	139
92-160-1P	7314150474172	70	139
92-160-25	7314150486700	25	139
92-160-3P	7314150474196	46	139
92-165-1P	7314150475018	90	140
92-166-1P	7314150474974	50	140
92-174-1P	7314150474936	90	140
92-205-1P	7314150474219	70	139
92-205-25	7314150486724	25	139
92-205-3P	7314150474356	46	139
92-221-1P	7314150474721	70	139
92-222-1P	7314150474592	70	139
92-222-25	7314150486748	25	139
92-222-3P	7314150474370	46	139
92-223-1P	7314150474684	70	139



92-223-3P	7314150474400	46	139
92-225-1P	7314150474707	70	139
92-225-25	7314150486779	25	139
92-226-1P	7314150475032	90	140
92-228-1P	7314150474745	70	139
92-228-25	7314150486793	25	139
92-229-1P	7314150474769	70	139
92-236-1P	7314150474806	70	139
92-245-1P	7314150475056	90	140
92-251-1P	7314150474868	70	140
92-WM-SET-8P	7314150486830	34	140
9210	7311518278182	1	654
9210-1	7311518278212	1	654
9210-10	7311518278229	1	654
9210-1060177	7311518295424	1	655
9210-1060238	7311518295394	20	655
9210-1230219	7311518295387	20	655
9210-1230235	7311518295325	1	654
9210-1320281	7311518295431	10	655
9210-1640142	7311518295356	1	654
9210-1690148	7311518295332	1	654
9210-1700118	7311518295363	1	655
9210-1710266	7311518295417	1	655
9210-1720100	7311518295295	1	654
9210-1730107	7311518295349	10	654
9210-1770106	7311518295370	10	655
9210-1830137	7311518295400	1	655
9210-20	7311518278236	1	654
92C	7314150182398	5	40
93C	7314150182404	5	40
94C	7314150182411	5	40
9500DZ-1.13/16	7314150227501	1	103
9500DZ-1.5/8	7314150227495	1	103
9500DZ-1.7/8	7314150227518	1	103
9500DZ-2	7314150227525	1	103
9500DZ-2.1/2	7314150227570	1	103
9500DZ-2.1/4	7314150227556	1	103
9500DZ-2.1/8	7314150227532	1	103
9500DZ-2.15/16	7314150227617	1	103
9500DZ-2.3/16	7314150227549	1	103
9500DZ-2.3/4	7314150227600	1	103
9500DZ-2.3/8	7314150227563	1	103
9500DZ-2.5/8	7314150227594	1	103
9500DZ-2.9/16	7314150227587	1	103
9500DZ-3	7314150227624	1	103
9500DZ-3.1/8	7314150227631	1	103
9500SM-41	7314153013699	1	102
9500SM-46	7314153013705	1	102
9500SM-50	7314153013712	1	102
9500SM-54	7314153013729	1	102
9500SM-55	7314153013736	1	102
9500SM-58	7314153013743	1	102
9500SM-60	7314153013750	1	103
9500SM-63	7314153013767	1	103
9500SM-65	7314153013774	1	103
9500SM-67	7314153013781	1	103
9500SM-70	7314153013798	1	103
9500SM-71	7314153013804	1	103
9500SM-75	7314153013811	1	103
9500SM-77	7314153013828	1	103
9500SM-80	7314153013835	1	103
9500SM-82	7314153013842	1	103
9505-3400	7314150125517	1	116
9505-TM	7314150125487	1	115
95155B-3000	7314150415410	1	116
9525-10	7311518031817	1	156
9525-3400	7314150125524	1	116
9525-7	7311518031800	1	156
9525CR-4000	7314150415465	1	116
9526B-4500	7314150415427	1	116
9527CR-2000	7314150415458	1	116
9528-MD-15-45	7311518007447	10	155
9528-MD-22-76	7311518041441	10	155
9540DZ	7314150414048	1	79
9540DZL	7314150414055	1	79
9540MB	7314153014108	1	79
9540MBL	7314153014115	1	79
9550N	7314150424160	1	103
9550N-SPARE	7314150424153	1	104
9550N/A	7314150424146	1	104
9550N/B	7314150424788	1	103
9555	7314153014047	1	103
9555AB	7314153014061	1	103
956	7314150025190	1	586
9560AB	7314153014078	1	103
9563AB	7314153014085	1	103
9564	7314151107543	1	102
9565AB	7314153014092	1	103
9566A	7314150220618	1	103
9572	7314150178599	5	40
9572-200	7311518004231	20	558
9572-250	7311518004248	20	558
9574-200	7314150138197	10	558
9574-250	7314150138203	10	558
9574-300	7314150180356	10	558
9575-250	7314150185894	6	558





95C	7314150182428	1	40
960100010	8413345031073	1	471
960100020	8413345031080	1	471
960100030	8413345031097	1	471
960100050	8413345031103	1	471
960100060	8413345031110	1	471
9625-6.35QC	7314150441716	1	156
9625-9500	7314150125555	1	116
96255CR-7000	7314150415489	1	116
9626-10	7314150388844	1	154
9626-11	7314150388851	1	154
9626-12	7314150388868	1	154
9626-13	7314150388875	1	154
9626-14	7314150388882	1	154
9626-15	7314150444526	1	154
9626-16	7314150388899	1	154
9626-18	7314150388905	1	154
9626-20	7314150388912	1	154
9626-22	7314150388929	1	154
9626-23	7314150388936	1	154
9626-24	7314150388943	1	154
9626-25	7314150388950	1	154
9626-26	7314153024237	1	154
9626-28	7314150388967	1	154
9626-30	7314150388974	1	154
9626-32	7314150388981	1	154
9626-35	7314150444533	1	154
9626-6	7314150388806	1	154
9626-7	7314150388813	1	154
9626-8	7314150388820	1	154
9626-9	7314150388837	1	154
9627-10-460	7314150389018	1	154
9627-12-460	7314150389025	1	154
9627-14-460	7314150389032	1	154
9627-16-460	7314150389049	1	154
9627-18-460	7314150389056	1	154
9627-20-460	7314150389063	1	154
9627-22-460	7314150389070	1	154
9627-24-460	7314150389087	1	154
9627-26-460	7314150389094	1	154
9627-28-460	7314150389100	1	154
9627-30-460	7314150389117	1	154
9627-32-460	7314150389124	1	154
9627-6-460	7314150388998	1	154
9627-8-460	7314150389001	1	154
9629-10	7314150388479	1	155
9629-12	7314150388486	1	155
9629-13	7314150440238	1	155
9629-14	7314150388493	1	155
9629-16	7314150388509	1	155
9629-17	7314150440245	1	155
9629-18	7314150388516	1	155
9629-19	7314150440252	1	155
9629-20	7314150388523	1	155
9629-22	7314150388530	1	155
9629-24	7314150388547	1	155
9629-25	7314150388554	1	155
9629-26	7314150388561	1	155
9629-28	7314150388578	1	155
9629-30	7314150388585	1	155
9629-32	7314150388592	1	155
9629-35	7314150440269	1	155
9629-36	7314150388608	1	155
9629-38	7314150388615	1	155
9629-40	7314150388622	1	155
9629-6	7314150388417	1	155
9629-8	7314150388462	1	155
9629-SET-8	7314150441648	10	155
9631-10-400	7314150388684	1	155
9631-12-400	7314150388691	1	155
9631-13-400	7314150447572	1	155
9631-14-400	7314150388707	1	155
9631-16-400	7314150388714	1	155
9631-18-400	7314150388721	1	155
9631-19-400	7314150447589	1	155
9631-20-400	7314150388738	1	155
9631-22-400	7314150388745	1	155
9631-24-400	7314150388752	1	155
9631-25-400	7314150432066	1	155
9631-28-400	7314150388776	1	155
9631-30-400	7314150388783	1	155
9631-32-400	7314150388790	1	155
9631-35-400	7314150447596	1	155
9631-38-400	7314150447602	1	155
9631-6-400	7314150388646	1	155
9631-8-400	7314150388677	1	155
9646-10	7314150388264	1	155
9646-10-250	7314150388387	1	155
9646-11	7314150388288	1	155
9646-12	7314150388295	1	155
9646-12-250	7314150388400	1	155
9646-13	7314150388301	1	155
9646-14	7314150388318	1	155
9646-15	7314150388325	1	155
9646-16	7314150388332	1	155
9646-18	7314150388349	1	155



9646-20	7314150388356	1	155
9646-3	7314150388189	1	155
9646-4	7314150388202	1	155
9646-5	7314150388219	1	155
9646-6	7314150388226	1	155
9646-6-250	7314150388363	1	155
9646-7	7314150388233	1	155
9646-8	7314150388240	1	155
9646-8-250	7314150388370	1	155
9646-9	7314150388257	1	155
9646-SET-5	7314150441686	1	155
9646-SET-8	7314150441693	1	155
9656-SET-6	7314150486953	1	155
96C	7314150134120	1	40
97-1	7314150366637	1	119
97-1/2	7314150366545	1	119
97-1/4	7314150366507	1	119
97-10	7314150366286	1	118
97-11	7314150366293	1	118
97-11/16	7314150366583	1	119
97-12	7314150366309	1	118
97-13	7314150366316	1	118
97-13/16	7314150366606	1	119
97-14	7314150366323	1	118
97-15	7314150366330	1	118
97-15/16	7314150366620	1	119
97-16	7314150366347	1	118
97-17	7314150366354	1	118
97-17/32	7314150366552	1	119
97-18	7314150366361	1	118
97-19	7314150366378	1	118
97-21	7314150366385	1	118
97-22	7314150349722	1	118
97-24	7314150357048	1	118
97-27	7314150366392	1	118
97-3/4	7314150366590	1	119
97-3/8	7314150366521	1	119
97-30	7314150366408	1	118
97-32	7314150366415	1	118
97-5/16	7314150366514	1	119
97-5/8	7314150366576	1	119
97-7	7314150366255	1	118
97-7/16	7314150366538	1	119
97-7/8	7314150366613	1	119
97-8	7314150366262	1	118
97-9	7314150366279	1	118
97-9/16	7314150366569	1	119
9710-10-175	7314151785789	5	216
9710-3.5-75	7314151785192	10	216
9710-5.5-100	7314151785352	10	216
9710-6.5-125	7314151785437	10	216
9710-8-150	7314151785512	5	216
9710/S6	7314151802301	1	217
9715-14-250	7314153010148	5	218
9733	7314150103256	1	257
9778-1	7314151793524	10	216
9778-2	7314151793531	10	216
9778-3	7314151793548	5	216
9778PZD-1	7314151823535	10	217
9778PZD-2	7314151823542	10	217
97C	7314150128211	1	40
98-1/2	7314150367481	1	120
98-1/4	7314150367443	1	120
98-10	7314150367320	1	119
98-11	7314150367337	1	119
98-11/16	7314150367511	1	120
98-12	7314150367344	1	119
98-13	7314150367351	1	119
98-13/16	7314150367535	1	120
98-14	7314150367368	1	119
98-15	7314150367375	1	119
98-16	7314150367382	1	119
98-17	7314150367399	1	119
98-18	7314150367405	1	119
98-19	7314150367412	1	119
98-21	7314150367429	1	119
98-22	7314150367436	1	119
98-3/4	7314150367528	1	120
98-3/8	7314150367467	1	120
98-5/16	7314150367450	1	120
98-5/8	7314150367504	1	120
98-7	7314150367290	1	119
98-7/16	7314150367474	1	120
98-7/8	7314150367542	1	120
98-8	7314150367306	1	119
98-9	7314150367313	1	119
98-9/16	7314150367498	1	120
981001100	7314150219902	1	447
982000170	7314150219926	1	478
982000320	7314150219919	1	438
982000350	7314150219933	1	439
983000320	7314150219940	1	438
983100320	7314150219964	1	438
984010320	7314150219971	1	439
9841	7314150107445	1	456
9848	7314150111015	1	439



98505	7314150216321	5	214
9852	7314150114092	1	456
9853	7314150103287	1	258
9873	7314150058082	1	258
9883	7314150043293	1	585
9897	7314150058068	1	258
9897G/3	7314150470020	1	258
9897S/3	7314150470044	1	514
99-1/2	7314150368150	1	120
99-10	7314150368013	1	120
99-11	7314150368020	1	120
99-11/16	7314150368181	1	120
99-12	7314150368037	1	120
99-13	7314150368044	1	120
99-14	7314150368051	1	120
99-16	7314150368068	1	120
99-17	7314150368075	1	120
99-18	7314150368082	1	120
99-19	7314150368099	1	120
99-21	7314150368105	1	120
99-22	7314150368112	1	120
99-24	7314150368129	1	120
99-3/4	7314150368198	1	120
99-3/8	7314150368136	1	120
99-5/8	7314150368174	1	120
99-7/16	7314150368143	1	120
99-9/16	7314150368167	1	120
9938	7314150056491	1	251
9A-14	7314150368204	1	120
9B-1/4	7314150366071	1	118
9B-5/16	7314150366088	1	118
9F-1/2	7314150366194	1	118
9F-1/4	7314150366170	1	118
9F-3/8	7314150366187	1	118
9P-1/2	7314150366057	1	118
9P-1/4	7314150366033	1	118
9P-3/8	7314150366040	1	118
9Q-1/2	7314150366019	1	118
9Q-1/4	7314150365999	1	118
9Q-3/8	7314150366002	1	118
9R-1/2	7314150365913	1	117
9R-1/4	7314150365890	1	117
9R-3/8	7314150365906	1	117
9T-1/2	7314150366118	1	117
9T-1/4	7314150366095	1	117
9T-3/8	7314150366101	1	117
9W	7314150354399	1	120
A0313M03	7311518023706	1	144
A0313M03E	7311518192150	1	144
A0313M03X	7311518182038	1	144
A0313M03XE	7311518181475	1	144
A0313M03XE-60	7311518184513	1	144
A0313M03XE-80	7311518201357	1	144
A0314I03	7314150501243	5	147
A0613M03X	7311518197872	1	144
A0616AL06E	7311518181802	1	145
A0616M06	7311518023737	1	144
A0616M06E	7311518023751	1	144
A0616M06X	7311518023768	1	144
A0616M06XE	7311518181468	1	144
A0618I06	7314150501267	5	147
A0618S06E	7314150501786	5	146
A0625M06X	7311518197780	1	146
A0820M06	7311518023805	1	144
A0820M06E	7311518023829	1	144
A0820M06X	7311518023836	1	144
A0820M06XE	7311518181994	1	144
A1020I06	7314150501304	5	147
A1020M06	7311518023874	1	144
A1020M06E	7311518023898	1	144
A1020M06X	7311518023904	1	144
A1020M06XE	7311518182007	1	144
A1020S06	7314150501335	5	146
A1020S06E	7314150501793	5	146
A1225AL06E	7311518187620	1	145
A1225AL08E	7311518181819	1	145
A1225I06	7314150506729	5	147
A1225M06	7311518023942	1	144
A1225M06E	7311518023966	1	144
A1225M06X	7311518023973	1	144
A1225M08	7311518100506	1	144
A1225M08E	7311518100520	1	144
A1225M08X	7311518187989	1	144
A1225M08XE	7311518192174	1	144
A1225S06	7314150501427	5	146
A1225S06E	7314150501809	5	146
A1625AL08XE	7311518244033	1	145
A1625M06	7311518192181	1	144
A1625M06X	7311518187361	1	144
A1625M06XE	7311518187354	1	144
A1625M08	7311518100568	1	144
A1625M08E	7311518100582	1	144
A1625M08X	7311518100599	1	144
A1625M08XE	7311518182021	1	144
A6700DM-10	7314151821722	5	80
A6700DM-11	7314151821739	5	80



A6700DM-12	7314151821746	5	80
A6700DM-13	7314151821753	5	80
A6700DM-14	7314151821760	5	80
A6700DM-5	7314150220632	5	80
A6700DM-5.5	7314151821678	5	80
A6700DM-6	7314151821685	5	80
A6700DM-7	7314151821692	5	80
A6700DM-8	7314151821708	5	80
A6700DM-9	7314151821715	5	80
A6700DZ-1/2	7314151751883	5	81
A6700DZ-1/4	7314151751371	5	81
A6700DZ-11/32	7314151819842	5	81
A6700DZ-3/16	7314151751029	5	81
A6700DZ-3/8	7314151751616	5	81
A6700DZ-5/16	7314151751531	5	81
A6700DZ-7/16	7314151819859	5	81
A6700DZ-7/32	7314151751296	5	81
A6700DZ-9/16	7314151751968	5	81
A6700DZ-9/32	7314151751456	5	81
A6709M-2.5	7314151753740	1	85
A6709M-3	7314151753825	1	85
A6709M-4	7314151754129	1	85
A6709M-5	7314151754471	1	85
A6709M-6	7314151754556	1	85
A6709Z-1/8	7314151755447	1	85
A6709Z-3/16	7314151755874	1	85
A6709Z-5/32	7314151755799	1	85
A6709Z-9/64	7314151755522	1	85
A6710DM-10	7314151756765	1	81
A6710DM-11	7314151756840	1	81
A6710DM-12	7314151756925	1	81
A6710DM-13	7314151757069	1	81
A6710DM-14	7314151757144	1	81
A6710DM-5.5	7314151756178	1	81
A6710DM-6	7314151756253	1	81
A6710DM-7	7314151756338	1	81
A6710DM-8	7314151756413	1	81
A6710DM-9	7314151756680	1	81
A6710DZ-1/2	7314151820466	1	82
A6710DZ-1/4	7314151757229	1	82
A6710DZ-11/32	7314151757571	1	82
A6710DZ-3/16	7314151820435	1	82
A6710DZ-3/8	7314151757656	1	82
A6710DZ-5/16	7314151757496	1	82
A6710DZ-7/16	7314151757731	1	82
A6710DZ-7/32	7314151820442	1	82
A6710DZ-9/16	7314151820473	1	82
A6710DZ-9/32	7314151820459	1	82
A6716DM	7314151820824	1	65
A6716DZ	7314151820831	1	67
A6718DZ	7314150312450	1	68
A6800DM-10	7314151821845	1	81
A6800DM-11	7314151821852	1	81
A6800DM-12	7314151821869	1	81
A6800DM-13	7314151821876	1	81
A6800DM-14	7314151821883	1	81
A6800DM-4	7314151821777	1	81
A6800DM-5	7314151821784	1	81
A6800DM-5.5	7314151821791	1	81
A6800DM-6	7314151821807	1	81
A6800DM-7	7314151821814	1	81
A6800DM-8	7314151821821	1	81
A6800DM-9	7314151821838	1	81
A6800DZ-1/2	7314151758899	1	81
A6800DZ-1/4	7314151758387	1	81
A6800DZ-11/32	7314151803872	1	81
A6800DZ-3/16	7314151758035	1	81
A6800DZ-3/8	7314151758622	1	81
A6800DZ-5/16	7314151758547	1	81
A6800DZ-7/16	7314151803889	1	81
A6800DZ-7/32	7314151758110	1	81
A6800DZ-9/16	7314151758974	1	81
A6800DZ-9/32	7314151758462	1	81
A6800SM-10	7314150360147	1	81
A6800SM-11	7314150360154	1	81
A6800SM-12	7314150360161	1	81
A6800SM-13	7314150360178	1	81
A6800SM-14	7314150360185	1	81
A6800SM-15	7314150360192	1	81
A6800SM-4	7314150360208	1	81
A6800SM-4.5	7314150360215	1	81
A6800SM-5	7314150360222	1	81
A6800SM-6	7314150360239	1	81
A6800SM-7	7314150360246	1	81
A6800SM-8	7314150360253	1	81
A6800SM-9	7314150360260	1	81
A6800SZ-1/8	7314150360277	1	81
A6800SZ-5/32	7314150360284	1	81
A7400DM-10	7314151819972	5	87
A7400DM-11	7314151819989	5	87
A7400DM-12	7314151819996	5	87
A7400DM-13	7314151820008	5	87
A7400DM-14	7314151820015	5	87
A7400DM-15	7314151820022	5	87
A7400DM-16	7314151820039	5	87
A7400DM-17	7314151820046	5	87



A7400DM-18



A7400DM-18	7314151820053	5	87
A7400DM-19	7314151820060	5	87
A7400DM-20	7314151820077	5	87
A7400DM-21	7314151820084	5	87
A7400DM-22	7314151820091	5	87
A7400DM-24	7314150386123	5	87
A7400DM-6	7314150118212	5	86
A7400DM-7	7314150118229	5	86
A7400DM-8	7314150118236	5	86
A7400DM-9	7314151819965	5	87
A7400DZ-1/2	7314151759780	5	87
A7400DZ-1/4	7314151759193	5	87
A7400DZ-11/16	7314151819897	5	87
A7400DZ-13/16	7314151819910	5	87
A7400DZ-17/32	7314151819866	5	87
A7400DZ-19/32	7314151819873	5	87
A7400DZ-3/4	7314151819903	5	87
A7400DZ-3/8	7314151759438	5	87
A7400DZ-5/16	7314151759278	5	87
A7400DZ-5/8	7314151819880	5	87
A7400DZ-7/16	7314151759513	5	87
A7400DZ-7/8	7314151819927	5	87
A7400DZ-9/16	7314151759865	5	87
A7402DM-10	7314151820138	1	87
A7402DM-11	7314151820145	1	87
A7402DM-12	7314151820152	1	87
A7402DM-13	7314151820169	1	87
A7402DM-14	7314151820176	1	87
A7402DM-15	7314151820183	1	87
A7402DM-16	7314151820190	1	87
A7402DM-17	7314151820206	1	87
A7402DM-18	7314151820213	1	87
A7402DM-19	7314151820220	1	87
A7402DM-21	7314150385881	1	87
A7402DM-7	7314150220243	1	87
A7402DM-8	7314150220250	1	87
A7402DM-9	7314150220267	1	87
A7402DZ-1/2	7314151760526	1	88
A7402DZ-1/4	7314151759940	1	88
A7402DZ-11/16	7314151820114	1	88
A7402DZ-13/16	7314153003027	1	88
A7402DZ-19/32	7314153003041	1	88
A7402DZ-3/4	7314151820121	1	88
A7402DZ-3/8	7314151760366	1	88
A7402DZ-5/16	7314151760014	1	88
A7402DZ-5/8	7314151820107	1	88
A7402DZ-7/16	7314151760441	1	88
A7402DZ-7/8	7314153003034	1	88
A7402DZ-9/16	7314151760793	1	88
A7410DZ-1/2	7314153006301	1	87
A7410DZ-11/16	7314153006332	1	87
A7410DZ-3/4	7314153006349	1	87
A7410DZ-3/8	7314153006288	1	87
A7410DZ-5/16	7314153006271	1	87
A7410DZ-5/8	7314153006325	1	87
A7410DZ-7/16	7314153006295	1	87
A7410DZ-9/16	7314153006318	1	87
A7435DME	7314153015006	1	71
A7440DME	7314153015419	1	71
A7440DZE	7314153014993	1	71
A7535DZE	7314153015013	1	71
ADJUST 3	7314150103515	1	39
ADJUST 3-90	7314150236336	1	38
ADJUST 9031/29	7314150302925	3	39
AP-234-F	7311518289027	2	642
AP-3M	7311518152062	1	641
AP-5M	7311518152079	1	641
APB260	7314150389162	10	626
APB360	7314150389186	10	626
AS-1200	7314150321520	3	559
AS-C33-JT-F	7314150341672	15	650
AS-C36-JT-M	7311518337490	15	650
AS-C39-JT-C	7314150341542	15	650
AS-C45-JT-C	7314150341559	15	650
ASP-1850	7311518337124	1	641
ASP-1850G	7311518337131	1	641
ASP-AS	7311518337377	6	641
ASP-AS-C33-JT-F	7314150341665	5	644
ASP-AS-C36-JT-M	7314150340590	5	644
ASP-AS-C39-JT-C	7314150341535	5	644
ASP-AS-C45-JT-C	7314150341566	2	644
ASP-AS-HOOK	7311518337582	4	642
ASP-ATP	7311518337384	6	641
ASP3740-C36JTM	7314150341818	1	644
ASP3740-C39JTC	7314150353347	1	644
ASP3740-C45JTC	7314150353354	1	644
ASP3740-P3437	7314150341801	1	642
ATP-110-210	7311518337575	1	641
ATP-200-350	7311518347062	1	641
ATP-200-500	7311518347055	1	641
ATP-230-410	7311518337599	2	642
AUTO	7314150438082	1	447
B141.007.075	7314150278404	5	202
B141.008.075	7314150278411	5	202
B141.009.075	7314150278428	5	202
B141.010.075	7314150278435	5	202



B141.015.100	7314150278442	5	202
B141.020.100	7314150278459	5	202
B141.025.125	7314150278466	5	202
B141.027.125	7314150278473	5	202
B141.030.150	7314150278480	5	202
B141.040.150	7314150278497	5	202
B142.000.075	7314150278718	10	506
B142.001.080	7314150278725	10	506
B142.001.150	7314150343188	10	506
B142.002.100	7314150278732	10	506
B142.002.175	7314150343195	10	506
B142.003.150	7314150278749	10	506
B143.020.100	7314150278510	5	202
B143.025.100	7314150278503	10	202
B143.030.100	7314150278527	10	202
B143.040.100	7314150278534	10	202
B143.050.100	7314150278541	10	202
B143.060.125	7314150278558	10	202
B143.080.150	7314150278565	5	202
B144.001.100	7314150278787	5	202
B144.002.125	7314150278794	5	202
B144.003.150	7314150278800	5	202
B145.006.100	7314150278756	5	203
B146.006.100	7314150278763	5	203
B147.001.400	7314150285594	1	373
B147.003.400	7314150285600	1	373
B148.001.080	7314150314522	10	506
B148.002.100	7314150314539	10	506
B149.001.080	7314150314546	10	506
B149.002.100	7314150314553	10	506
B150.010.100	7314150343126	10	506
B150.015.125	7314150343133	10	506
B150.020.125	7314150343140	10	506
B150.025.150	7314150343157	10	506
B190.040.075	7314150277810	10	200
B190.040.100	7314150277827	10	200
B190.055.100	7314150277834	10	200
B190.055.125	7314150277841	10	200
B190.065.125	7314150277858	10	200
B190.065.150	7314150277865	10	200
B190.080.150	7314150277872	10	200
B190.080.175	7314150277889	10	200
B190.100.200	7314150277896	10	200
B190.120.250	7314150277902	10	200
B190.140.250	7314150277919	10	200
B191.025.075	7314150277926	10	200
B191.030.075	7314150277933	10	200
B191.030.100	7314150277940	10	200
B191.030.200	7314150277957	10	200
B191.035.100	7314150277964	10	200
B191.040.100	7314150277971	10	200
B191.040.125	7314150277988	10	200
B191.040.250	7314150277995	10	200
B191.055.125	7314150278008	10	200
B191.055.150	7314150278015	10	200
B191.055.300	7314150278022	10	200
B191.065.150	7314150278039	10	200
B191.065.300	7314150278046	10	200
B192.000.075	7314150278084	10	201
B192.000.200	7314150278091	10	201
B192.001.100	7314150278107	10	201
B192.001.250	7314150278114	10	201
B192.002.125	7314150278121	10	201
B192.002.150	7314150442720	10	201
B192.002.300	7314150278138	10	201
B192.003.150	7314150278145	10	201
B192.004.200	7314150278169	10	201
B193.000.075	7314150278190	10	201
B193.001.100	7314150278206	10	201
B193.002.125	7314150278213	10	201
B193.003.150	7314150278220	10	201
B193.004.200	7314150278237	10	201
B194.004.075	7314150278268	10	202
B194.005.075	7314150278275	10	202
B194.006.075	7314150278282	10	202
B194.007.075	7314150278299	10	202
B194.008.075	7314150278305	10	202
B194.009.075	7314150278312	10	202
B194.010.075	7314150278329	10	202
B194.015.100	7314150278336	10	202
B194.020.100	7314150278343	10	202
B194.025.125	7314150278350	10	202
B194.027.125	7314150278367	10	202
B194.030.150	7314150278374	10	202
B194.040.150	7314150278381	10	202
B194.045.150	7314150278398	5	202
B195.001.025	7314150278176	10	201
B195.002.025	7314150278183	10	201
B195.006.050	7314150289493	5	203
B195.040.025	7314150278053	10	200
B195.050.025	7314150278060	10	200
B195.060.025	7314150278077	10	200
B195.901.025	7314150278244	10	201
B195.902.025	7314150278251	10	201
B196.025.075	7314150278589	10	505
B196.030.100	7314150278572	10	505



B196.035.100	7314150278596	10	505
B196.040.100	7314150278602	10	505
B196.055.125	7314150278619	10	505
B196.065.150	7314150278626	10	505
B196.080.175	7314150278633	10	505
B196.100.200	7314150278640	10	505
B196.120.200	7314150278657	10	505
B197.000.075	7314150278664	10	506
B197.001.080	7314150278671	10	506
B197.001.150	7314150343164	10	506
B197.002.100	7314150278688	10	506
B197.002.175	7314150343171	10	506
B197.003.150	7314150278695	10	506
B197.004.200	7314150278701	10	506
B198.040.125	7314150278817	5	203
B198.045.125	7314150278824	5	203
B198.050.150	7314150278831	5	203
B198.055.150	7314150281268	5	203
B198.060.150	7314150281763	5	203
B198.060.150F	7314150281770	5	203
B198.070.150	7314150281787	5	203
B198.070.150F	7314150281794	5	203
B198.080.150	7314150281800	5	203
B198.080.150F	7314150281817	5	203
B198.090.150	7314150281824	5	203
B198.100.150	7314150281831	5	203
B198.110.150	7314150281848	5	203
B198.120.150	7314150281855	5	203
B198.130.150	7314150281862	5	203
B198.140.150	7314150281879	5	203
B199.055.125	7314150281886	5	506
B199.060.125	7314150281893	5	506
B199.070.125	7314150281909	5	506
B199.080.125	7314150281916	5	506
B199.090.125	7314150281923	5	506
B199.100.125	7314150281930	5	506
B199.110.125	7314150281947	5	506
B199.120.125	7314150287741	5	506
B199.130.125	7314150287772	5	506
B219.002	7314150289301	1	203
B219.004	7314150283248	1	204
B219.005	7314150283255	1	204
B219.006	7314150283293	1	205
B219.007	7314150283323	1	205
B219.008	7314150283347	1	206
B219.010	7314150283354	1	207
B219.012	7314150327768	1	204
B219.015	7314150283262	1	204
B219.016	7314150283309	1	205
B219.017	7314150283330	1	206
B219.025	7314150283279	1	204
B219.026	7314150283316	1	205
B219.027	7314150399833	1	206
B219.035	7314150283286	1	205
B219.110	7314150392667	1	206
B219.210	7314150438969	1	207
B220.002	7314150289295	1	506
B220.005	7314150283361	1	507
B220.007	7314150283385	1	507
B220.012	7314150314614	1	506
B220.015	7314150283378	1	507
B220.017	7314150283392	1	507
B220.027	7314150283408	1	507
B400.002	8412814119441	1	622
B400.003	8412814119458	1	622
B400.004	8412814119465	1	622
B400.005	8412814119472	1	622
B400.006	8412814119489	1	622
B400.007	8412814119496	1	622
B400.008	8412814119502	1	623
B400.009	8412814119519	1	623
B400.010	8412814119526	1	623
B400.011	8412814119533	1	623
B400.012	8412814119540	1	623
B400.013	8412814119557	1	623
B400.014	8412814119564	1	623
B400.015	8412814119571	1	623
B400.016	8412814119588	1	623
B400.017	8412814119595	1	623
B400.018	8412814119601	1	623
B400.019	8412814119618	1	623
B400.020	8412814119625	1	623
B400.021	8412814119632	1	623
B400.022	8412814119649	1	623
B400.023	8412814119656	1	623
B400.024	8412814119663	1	623
B400.025	8412814119670	1	623
B400.026	8412814119687	1	623
B400.027	8412814119694	1	623
B400.028	8412814119700	1	623
B400.029	8412814119717	1	623
B400.030	8412814119724	1	623
B400.031	8412814119731	1	623
B400.032	8412814119748	1	623
B400.033	8412814119755	1	623
B400.034	8412814119762	1	623



B400.035	8412814119779	1	623
B400.036	8412814119786	1	623
B400.037	8412814119793	1	623
B400.038	8412814119809	1	623
B400.039	8412814119816	1	623
B400.040	8412814119823	1	623
B400.041	8412814119830	1	623
B400.042	8412814119847	1	623
B400.043	8412814119854	1	623
B400.044	8412814119861	1	623
B400.045	8412814119878	1	623
B400.046	8412814119885	1	623
B400.047	8412814119892	1	623
B400.048	8412814119908	1	623
B400.049	8412814119915	1	623
B400.050	8412814119922	1	623
B705.1/4.125	7314150281978	5	216
BAC007	7314150242337	1	313
BAHCO-1MW-1	7314150428045	1	436
BASIC	7314150437436	1	435
BB10	7314150240586	1	339
BB1200A	7314150170173	1	338
BBA12-1200	7314150254330	1	337
BBA1224-1700	7314150254347	1	337
BBA1224-3200	7314150341955	1	337
BBACCC12V	7314150430772	1	342
BBBC2A	7314150181520	1	341
BBBC4A	7314150181537	1	341
BBBCAB-AUZ	7314150183944	1	341
BBBCAB-EU	7314150186648	1	341
BBBCAB-UK	7314150183937	1	341
BBC420	7314150243235	1	339
BBC620	7314150243242	1	339
BBCE12-10	7314150330263	1	338
BBCE12-15S	7314150406722	2	338
BBCE12-3	7314150330249	2	338
BBCE12-6	7314150330256	2	338
BBCE12-F100	7314150344710	1	338
BBCE24-10	7314150330287	2	338
BBCE612-2	7314150330195	2	338
BBCEC1	7314150335459	1	341
BBCEC2	7314150337460	1	341
BB CER1	7314150335466	1	341
BB CER2	7314150337484	1	341
BBH12-1200	7314150360734	1	337
BBJL1630	7314150244898	5	338
BBJL2535	7314150209453	1	338
BBJL3545	7314150209460	1	338
BBR100	7314150345922	1	325
BBR110	7314150170562	1	325
BBR150I	7314150439119	24	328
BBR201P6	7314150205752	8	327
BBR201P64014	7314150237852	1	327
BBR201P64016	7314150237753	1	327
BBR201P64018	7314150237760	1	327
BBR201P67814	7314150237777	1	327
BBR201P67816	7314150237784	1	327
BBR201P67818	7314150237791	1	327
BBR202P4	7314150205769	1	328
BBR202P410	7314150207688	1	328
BBR202P414	7314150207695	1	328
BBR202P419	7314150207701	1	328
BBR202P455	7314150231393	1	328
BBR203P9	7314150208081	1	327
BBR203P920	7314150231102	1	327
BBR203P925	7314150231119	1	327
BBR203P927	7314150231126	1	327
BBR203P930	7314150231133	1	327
BBR203P940	7314150231140	1	327
BBR203P945	7314150231157	1	327
BBR203P950	7314150231164	1	327
BBR203P955	7314150231171	1	327
BBR203P960	7314150231188	1	327
BBR204	7314150430635	6	328
BBR210P3	7314150206056	1	328
BBR300P50	7314150269624	1	327
BBR320	7314150169887	1	327
BBR350	7314150169900	1	325
BBR400	7314150345939	1	326
BBR405	7314150435807	20	327
BBR410	7314150345946	24	326
BBR420	7314150403394	50	326
BBR501011	7314150438143	50	325
BBR50121314	7314150438150	50	325
BBR6131	7314150239443	1	328
BBR6135	7314150239450	1	328
BBRAS14	7314150416943	4	325
BBRAS14-01	7314150418060	1	326
BBRAS14-02	7314150418077	1	326
BBRAS14-03	7314150418084	1	326
BBRAS14-04	7314150418091	1	326
BBRAS14-05	7314150418107	1	326
BBRAS14-06	7314150418114	1	326
BBRAS14-07	7314150418121	1	326
BBRAS14-08	7314150418138	1	326
BBRAS14-09	7314150418145	1	326



BBRAS14-10



BBRAS14-10	7314150418152	1	326
BBRAS14-11	7314150418169	1	326
BBRAS14-12	7314150418176	1	326
BBRAS14-13	7314150418183	1	326
BBRAS14-14	7314150418190	1	326
BBRBB12	7314150371297	1	325
BBRFKM1	7314150384938	12	328
BBRPTG1	7314150412617	10	326
BBRS210P	7314150206070	1	328
BBRS210P2	7314150206063	1	328
BBS075	7314150249824	12	345
BBS100	7314150169870	1	349
BBS10001	7314150207183	1	349
BBS10002	7314150207190	1	349
BBS10003	7314150207206	1	349
BBS10004	7314150207213	1	349
BBS10005	7314150207220	1	349
BBS100057	7314150186655	1	349
BBS10006	7314150207237	1	349
BBS10007	7314150207244	1	349
BBS10008	7314150207251	1	349
BBS10009	7314150207268	1	349
BBS10010	7314150207275	1	349
BBS101	7314150243525	1	346
BBS102	7314150243518	1	346
BBS103	7314150243488	1	345
BBS10450	7314150243501	1	346
BBS105	7314150250868	1	346
BBS106	7314150243495	1	345
BBS107	7314150250875	1	346
BBS108	7314150250882	1	346
BBS12SH	7314150243563	1	347
BBS150	7314150169849	1	345
BBS150R	7314150244959	1	346
BBS150S	7314150244973	1	346
BBS150T	7314150244966	1	346
BBS165	7314150205615	10	346
BBS165SP4	7314150205622	50	346
BBS170P13	7314150205608	1	346
BBS170P131	7314150231843	1	346
BBS170P132	7314150231850	1	346
BBS170P133	7314150231867	1	346
BBS170P134	7314150231874	1	346
BBS170P135	7314150231881	1	346
BBS170P136	7314150231898	1	346
BBS170P137	7314150231904	1	346
BBS170P138	7314150231911	1	346
BBS170P139	7314150231928	1	346
BBS200	7314150239498	1	348
BBS20P12	7314150169856	1	349
BBS210	7314150215362	1	349
BBS210U06	7314150217656	1	349
BBS210U08	7314150217663	1	349
BBS210UA06	7314150217670	1	349
BBS210UA08	7314150217687	1	349
BBS210V06	7314150217632	1	349
BBS210V08	7314150217649	1	349
BBS210W06	7314150218738	1	349
BBS210W08	7314150218745	1	349
BBS3BH1	7314150356843	1	345
BBS3BH1-VP	7314150355501	40	345
BBS3UH	7314150242351	1	345
BBS50	7314150169863	1	344
BBS702026	7314150187416	15	341
BBS702028	7314150187423	1	341
BBSDA	7314150247127	1	348
BBSDC	7314150247158	6	348
BBSDD	7314150247165	1	348
BBSDH	7314150247141	1	348
BBSDHR	7314150249299	1	348
BBSDT	7314150247134	6	348
BBSDW	7314150247110	6	348
BBSH1F	7314150247189	1	347
BBSH1M	7314150247196	1	347
BBSH2C	7314150247202	1	347
BBSH2CA	7314150247219	12	347
BBSH2CP	7314150247226	6	347
BBSH2F	7314150247172	6	347
BBSH3CF	7314150247240	6	347
BBSH3CF30	7314150247264	6	347
BBSH3FS	7314150247257	6	347
BBSH3MF	7314150247233	1	347
BBSHWH1	7314150328932	1	347
BBSNL4FX001	7314150187492	1	342
BBSS1	7314150247288	1	348
BBSS2	7314150247271	8	348
BBSS2L	7314150247295	1	348
BBT20	7314150166961	1	339
BBT60A	7314150504169	36	339
BBT80	7314150327805	6	339
BCL31B1	7314150389704	1	293
BCL31C1	7314150389742	1	293
BCL31D1	7314150389582	1	291
BCL31D1K1	7314150400843	1	291
BCL31IS1	7314150389599	1	291
BCL31IS1K1	7314150400836	1	291



BCL31IW1	7314150389551	1	290
BCL31IW1K1	7314150400829	1	290
BCL31R1	7314150389568	1	290
BCL31R1K1	7314150400850	1	291
BCL31SD1	7314150389575	1	291
BCL31SD1K1	7314150402656	1	291
BCL32B1	7314150389711	1	293
BCL32DG1	7314150389605	1	292
BCL32DG1K1	7314150402670	1	292
BCL32G1	7314150389629	1	293
BCL32G1K1	7314150400911	1	292
BCL32IW1	7314150389643	1	290
BCL32IW1K1	7314150402663	1	290
BCL32RS1	7314150389636	1	292
BCL32RS1K1	7314150400904	1	292
BCL32SP1	7314150389612	1	292
BCL32SP1K1	7314150400898	1	292
BCL33AP1	7314150389650	1	292
BCL33AP1K1	7314150402687	1	292
BCL33B1	7314150389728	1	293
BCL33B3	7314150389735	1	293
BCL33C1	7314150389759	1	293
BCL33C2	7314150389766	1	293
BCL33D1	7314150389681	1	291
BCL33D1K1	7314150400881	1	291
BCL33IW1	7314150389667	1	290
BCL33IW1K1	7314150400867	1	290
BCL33IW2	7314150389674	1	290
BCL33IW2K1	7314150400874	1	290
BDACM1000	7314150500819	30	339
BE-3529	7314151847845	5	548
BE-6400M-4	7314153011145	5	192
BE-6400M-5	7314153011169	5	192
BE-6400M-5.5	7314153011176	5	192
BE-6400M-7	7314153011190	5	192
BE-6902	7314150242641	5	190
BE-6903	7314150242665	5	190
BE-6925	7314150242658	5	190
BE-6990-IP10	7314151846763	1	114
BE-6990-IP10-KL	7314151847531	10	115
BE-6990-IP15	7314151846770	1	114
BE-6990-IP15-KL	7314151847548	10	115
BE-6990-IP20-KL	7314151848668	10	115
BE-6990-IP6	7314151846725	1	114
BE-6990-IP6-KL	7314151847494	10	115
BE-6990-IP7	7314151846732	1	114
BE-6990-IP7-KL	7314151847500	10	115
BE-6990-IP8	7314151846749	1	114
BE-6990-IP8-KL	7314151847517	10	115
BE-6990-IP9	7314151846756	1	114
BE-6990-IP9-KL	7314151847524	10	115
BE-6990-IPSET	7314153019356	1	114
BE-6990TX-T10KL	7314151847760	10	115
BE-6990TX-T15KL	7314151847777	10	115
BE-6990TX-T20KL	7314151848682	10	115
BE-6990TX-T6-KL	7314151847722	10	115
BE-6990TX-T7-KL	7314151847739	10	115
BE-6990TX-T8-KL	7314151847746	10	115
BE-6990TX-T9-KL	7314151847753	10	115
BE-7515	7314150242528	5	190
BE-7520	7314150242535	5	190
BE-7525	7314150242542	5	190
BE-7527	7314150242559	5	190
BE-7530	7314150242566	5	190
BE-7540	7314150242573	5	190
BE-7606	7314151839017	5	192
BE-7607	7314151839024	5	192
BE-7608	7314151839031	5	192
BE-7675	7314150123896	1	228
BE-7715	7314150242580	5	190
BE-7720	7314150242597	5	190
BE-7725	7314150242603	5	190
BE-7727	7314150242610	5	190
BE-7730	7314150242627	5	190
BE-7740	7314150242634	5	190
BE-7803	7314151838867	5	192
BE-7804	7314151838881	5	192
BE-7805	7314151838904	5	192
BE-7806	7314151838928	5	192
BE-7806S	7314150242986	5	502
BE-7807	7314151838935	5	192
BE-7807S	7314150242993	5	502
BE-7808	7314151838942	5	192
BE-7808S	7314150243006	5	502
BE-7809	7314151838959	5	192
BE-7809S	7314150243013	5	502
BE-7810	7314151838966	5	192
BE-7810S	7314150243020	5	502
BE-7811	7314151838973	5	192
BE-7812	7314151838980	5	192
BE-7813	7314151838997	5	192
BE-7814	7314151839000	5	192
BE-7835	7314151838874	5	192
BE-7845	7314151838898	5	192
BE-7855	7314151838911	5	192
BE-7855S	7314150242979	5	502



BE-7907	7314153010964	5	190
BE-7908	7314153010971	5	190
BE-7909	7314153010988	5	190
BE-7910	7314151838799	5	190
BE-7915	7314151838805	5	190
BE-7920	7314151838812	5	190
BE-7925	7314151838829	5	190
BE-7927	7314151838836	5	190
BE-7930	7314151838843	5	190
BE-7940	7314151838850	5	190
BE-8002	7314150242825	5	188
BE-8010	7314150010615	5	188
BE-8010S	7314150033058	5	502
BE-8020	7314150010639	5	188
BE-8020I	7314150270316	5	540
BE-8020L	7314151838591	5	188
BE-8022	7314150242474	5	188
BE-8030	7314150010653	5	188
BE-8030I	7314150270330	5	540
BE-8040	7314150010677	5	188
BE-8040I	7314150270347	5	540
BE-8040S	7314150033089	5	502
BE-8040SL	7314150304578	10	504
BE-8050S	7314150033096	5	502
BE-8050SL	7314150304592	10	504
BE-8065S	7314150033119	5	502
BE-8080-1	7314153010995	5	191
BE-8080-10	7314153011060	5	191
BE-8080-2	7314153011008	5	191
BE-8080-3	7314153011015	5	191
BE-8080-4	7314153011022	5	191
BE-8080-5	7314153011039	5	191
BE-8080-6	7314153011046	5	191
BE-8080-8	7314153011053	5	191
BE-8135TB	7314150275052	10	198
BE-8145TB	7314150275076	10	198
BE-8150	7314150010707	5	188
BE-8150TB	7314150275113	10	198
BE-8155	7314150010721	5	188
BE-8155TB	7314150275090	5	198
BE-8158	7314153010858	5	188
BE-8159	7314153010865	5	188
BE-8160	7314150010745	5	188
BE-8210	7314151838584	5	188
BE-8220	7314150047741	5	188
BE-8220S	7314150048243	5	502
BE-8220SL	7314150304530	10	504
BE-8225	7314150242443	5	188
BE-8230	7314150047758	5	188
BE-8230S	7314150048250	5	502
BE-8230SL	7314150304554	10	504
BE-8235	7314150242450	5	188
BE-8240	7314150047765	5	188
BE-8241	7314150242467	5	188
BE-8241I	7314150270866	5	540
BE-8242	7314153010803	5	188
BE-8250	7314150047772	5	188
BE-8250L	7314151838607	5	188
BE-8251	7314150242481	5	188
BE-8252	7314153010810	5	188
BE-8252I	7314150270361	5	540
BE-8255	7314150047789	5	188
BE-8255S	7314150048281	5	502
BE-8255SL	7314150304615	10	504
BE-8256	7314153010827	5	188
BE-8256TB	7314150275137	10	198
BE-8257	7314153010834	5	188
BE-8258	7314153010841	5	188
BE-8258S	7314150242818	5	502
BE-8258TB	7314150275151	10	198
BE-8259S	7314150242832	5	502
BE-8260	7314150047796	5	188
BE-8262TB	7314150275526	10	198
BE-8330	7314151838614	5	188
BE-8340	7314151838621	5	188
BE-8350	7314151838638	5	188
BE-8355	7314151838652	5	188
BE-8360	7314151838676	5	188
BE-8450	7314151838645	5	188
BE-8455	7314151838669	5	188
BE-8510S	7314150126507	5	502
BE-8510SL	7314150304813	10	504
BE-8520S	7314150126514	5	502
BE-8520SL	7314150304837	10	504
BE-8571	7314150244652	1	197
BE-8572	7314150244669	1	197
BE-8573	7314150244676	1	198
BE-8574	7314150258666	1	198
BE-8575	7314150244638	1	195
BE-8576	7314150245741	1	198
BE-8577	7314151839048	5	195
BE-8600	7314150010769	5	188
BE-8600I	7314150270378	5	540
BE-8600S	7314150033126	5	502
BE-8601	7314151838706	5	189
BE-8602	7314151838713	5	189



BE-8605	7314150242498	5	188
BE-8608	7314150242504	5	188
BE-8610	7314150010776	5	188
BE-8610I	7314150270392	5	540
BE-8610L	7314151838683	5	188
BE-8610S	7314150033133	5	502
BE-8610SL	7314150304639	10	504
BE-8610TB	7314150275199	10	199
BE-8611	7311518292317	5	188
BE-8611S	7314150414703	5	502
BE-8612S	7314150242856	5	502
BE-8620	7314150010783	5	189
BE-8620I	7314150270408	5	540
BE-8620L	7314151838690	5	189
BE-8620S	7314150033140	5	502
BE-8620SL	7314150304653	10	504
BE-8620TB	7314150275212	10	199
BE-8621	7311518292324	5	189
BE-8621S	7314150242863	5	502
BE-8622	7314150242511	5	189
BE-8622S	7314150242870	5	502
BE-8623	7314153010872	5	189
BE-8623I	7314150270415	5	540
BE-8623TB	7314150275236	10	199
BE-8624	7314153010889	5	189
BE-8624TB	7314150275250	10	199
BE-8628	7314153010896	5	189
BE-8629	7314153010902	5	189
BE-8630	7314150010790	5	189
BE-8630S	7314150033157	5	502
BE-8640	7314150010806	5	189
BE-8640S	7314150033164	5	502
BE-8675	7314150123872	1	228
BE-8700-1/4	7314150242689	5	191
BE-8700-3/16	7314150242696	5	191
BE-8700-3/8	7314150242702	5	191
BE-8700-5/16	7314150242719	5	191
BE-8700-5/32	7314150242726	5	191
BE-8700-7/32	7314150242733	5	191
BE-8700-7/64	7314150275878	5	191
BE-8702	7314151838768	5	191
BE-8703	7314150027651	5	191
BE-8703S	7314151839130	5	502
BE-8704	7314150027668	5	191
BE-8704S	7314151839147	5	502
BE-8705	7314150027675	5	191
BE-8705S	7314151839154	5	502
BE-8706	7314150027682	5	191
BE-8706S	7314151839161	5	502
BE-8708	7314150027699	5	191
BE-8708S	7314151839178	5	502
BE-8710	7314150027705	5	191
BE-8710S	7314150126521	5	502
BE-8710SL	7314150304851	10	504
BE-8715	7314150242672	5	191
BE-8720S	7314150126538	5	502
BE-8720SL	7314150304875	10	504
BE-8725	7314151838775	5	191
BE-8725S	7314151839123	5	502
BE-8800	7314150042012	5	189
BE-8800I	7314150270422	5	540
BE-8800S	7314151839055	5	502
BE-8801	7314151838744	5	189
BE-8802	7314151838751	5	189
BE-8810	7314150010813	5	189
BE-8810I	7314150270439	5	540
BE-8810L	7314151838720	5	189
BE-8810S	7314150048298	5	502
BE-8810SL	7314150304677	10	504
BE-8810TB	7314150275274	10	199
BE-8811	7311518292331	5	189
BE-8811S	7314150414710	5	502
BE-8812S	7314150242894	5	502
BE-8820	7314150010820	5	189
BE-8820I	7314150270446	5	540
BE-8820L	7314151838737	5	189
BE-8820S	7314150048304	5	502
BE-8820SL	7314150304691	10	504
BE-8820TB	7314150275298	10	199
BE-8821	7311518292348	5	189
BE-8821S	7314150242900	5	502
BE-8822S	7314150242917	5	502
BE-8823	7314153010919	5	189
BE-8823I	7314150270453	5	540
BE-8823TB	7314150275311	10	199
BE-8824	7314153010926	5	189
BE-8824TB	7314150275335	10	199
BE-8828	7314153010933	5	189
BE-8829	7314153010940	5	189
BE-8830	7314150010837	5	189
BE-8830S	7314150048311	5	502
BE-8840	7314150010844	5	189
BE-8840S	7314151839062	5	502
BE-8865	7314150010851	5	188
BE-8870	7314150010875	5	188
BE-8880	7314150010899	5	188





BE-8890	7314150010905	5	188
BE-8904	7314153010957	5	190
BE-8905	7314153010049	5	190
BE-8905S	7314150242924	5	502
BE-8906	7314150027729	5	190
BE-8906S	7314150242931	5	502
BE-8907	7314150027736	5	190
BE-8907S	7314150242948	5	502
BE-8908	7314150027743	5	190
BE-8908S	7314150242955	5	502
BE-8909	7314150027750	5	190
BE-8909S	7314150242962	5	502
BE-8910	7314150027767	5	190
BE-8910I	7314150270460	5	540
BE-8910S	7314151839079	5	502
BE-8910SL	7314150304714	5	504
BE-8910TB	7314150275359	5	199
BE-8915	7314150027774	5	190
BE-8915I	7314150270477	5	540
BE-8915S	7314151839086	5	502
BE-8915SL	7314150304738	5	504
BE-8915TB	7314150275373	5	199
BE-8920	7314150027781	5	190
BE-8920I	7314150270484	5	540
BE-8920S	7314151839093	5	502
BE-8920SL	7314150304752	5	504
BE-8920TB	7314150275397	5	199
BE-8925	7314150027798	5	190
BE-8925I	7314150270491	5	540
BE-8925S	7314151839109	5	502
BE-8925SL	7314150304776	5	504
BE-8925TB	7314150275410	5	199
BE-8927	7314150027804	5	190
BE-8927TB	7314150275434	5	199
BE-8930	7314150027811	5	190
BE-8930S	7314151839116	5	502
BE-8930SL	7314150304790	5	504
BE-8930TB	7314150275458	5	199
BE-8940	7314150027828	5	190
BE-8940TB	7314150275472	5	199
BE-8945	7314151838782	5	190
BE-8975	7314150056576	6	227
BE-8975B	7314150188741	6	227
BE-8976B	7314150216369	6	228
BE-8980	7314153010681	5	192
BE-8985	7314153010698	5	191
BE-8986	7314150267026	5	192
BE-9001	7311518269005	5	191
BE-9002	7311518269012	5	191
BE-9003	7311518269029	5	191
BE-9100	7314150242757	5	191
BE-9101	7314150242764	5	191
BE-9102	7314150242771	5	191
BE-9103	7314150242788	5	191
BE-9104	7314150242795	5	191
BE-9105	7314150242801	5	191
BE-9575	7314150123841	1	227
BE-9578	7314150123803	1	224
BE-9585	7314150123858	1	227
BE-9586	7314150216000	1	224
BE-9588	7314150123810	1	225
BE-9675	7314150123889	1	227
BE-9676	7314150216017	1	225
BE-9678	7314150123827	1	225
BE-9688	7314150123834	1	225
BE-9765	7314150055128	3	225
BE-9770	7314150027712	3	225
BE-9770I	7314150276332	20	541
BE-9775	7314150056330	3	226
BE-9776	7314150056545	6	224
BE-9776B	7314150216352	6	225
BE-9777	7314150056552	6	224
BE-9777B	7314150188734	6	224
BE-9780	7314150033386	3	226
BE-9785	7314150056347	3	226
BE-9785I	7314150276349	1	540
BE-9786I	7314150314485	1	541
BE-9787	7314150056569	6	224
BE-9871	7314150234707	1	194
BE-9871SL	7314150470792	1	505
BE-9872	7314150440412	1	194
BE-9872SL	7314150470785	1	505
BE-9875	7314150314447	1	194
BE-9876S	7314150315000	1	504
BE-9877	7314150320745	1	195
BE-9878	7314150186259	1	222
BE-9878SL	7314150321018	1	505
BE-9879	7314150383474	1	194
BE-9880	7314150238569	3	223
BE-9880SL	7314150337651	1	505
BE-9881	7314150043279	1	193
BE-9881I	7314150270507	1	540
BE-9881S	7314151839307	1	503
BE-9881SL	7314150304899	1	505
BE-9881TB	7314150275502	1	199
BE-9882	7314151839284	1	193



BE-9882I	7314150270514	1	540
BE-9882S	7314151839314	1	503
BE-9882SL	7314150304912	1	505
BE-9882TB	7314150275496	1	199
BE-9884	7314150243068	1	193
BE-9884S	7314150236602	1	503
BE-9885	7314150048465	1	193
BE-9885S	7314150126491	1	503
BE-9885TB	7314150275519	1	200
BE-9886	7314150048472	1	193
BE-9887S	7314150244744	1	503
BE-9888S	7314153006158	1	503
BE-9889S	7314150244751	1	503
BE-9890S	7314150237715	1	503
BE-9890SL	7314150315086	1	504
BE-9891SL	7314150321506	1	504
BE-9894SL	7314150321490	1	505
BE100	7314150177912	1	306
BE1100	7314150205929	8	309
BE110001	7314150230228	1	309
BE110014	7314150230204	1	308
BE110015	7314150230211	1	308
BE1100AC1	7314150230266	1	308
BE1100AC2	7314150333394	1	308
BE1200P6	7314150205516	1	307
BE1200P6AC1	7314150205523	1	307
BE1205	7314150205554	1	306
BE1210P11	7314150209101	1	307
BE1210P1101	7314150269822	1	306
BE1210P1102	7314150269839	1	306
BE1210P1103	7314150269846	1	306
BE1210P9AC1	7314150205547	1	307
BE1300	7314150205578	1	305
BE1300SH	7314150205585	10	305
BE1305P450	7314150206032	1	305
BE1305P450WS01	7314150269228	1	305
BE1305P450WS02	7314150269235	1	305
BE1305P450WS03	7314150269242	1	305
BE1305P450WS04	7314150269327	1	305
BE1305P450WS05	7314150269334	1	305
BE1305P450WS06	7314150269341	1	305
BE1305P450WS07	7314150269358	1	305
BE1305P450WS08	7314150269365	1	305
BE1305P450WS09	7314150269372	1	305
BE1305P450WS10	7314150269310	1	305
BE1305P450WS11	7314150269389	1	305
BE1305P450WS12	7314150269396	1	305
BE1305P450WS13	7314150269402	1	305
BE1305P450WS14	7314150269419	1	305
BE1305P450WS15	7314150269426	1	305
BE1310DNS	7314150403240	12	305
BE1310P4	7314150205707	1	304
BE1310P425	7314150233649	1	304
BE1310P427	7314150233656	1	304
BE1310P429	7314150233663	1	304
BE1310P430	7314150233670	1	304
BE1311P13	7314150235414	1	304
BE1312DNS	7314150450596	12	305
BE1315P7	7314150205776	1	305
BE1315P71	7314150230273	1	305
BE1315P72	7314150230280	1	305
BE1315P73	7314150230297	1	305
BE1315P74	7314150230303	1	305
BE1315P75	7314150230310	1	305
BE1315P76	7314150230327	1	305
BE1315P77	7314150230334	1	305
BE1320S17	7314150415366	10	304
BE13ZL11	7314150239733	1	306
BE1FFWF	7314150403325	12	315
BE1FLD1	7314150250745	1	315
BE1FLD2	7314150250752	1	315
BE1FLD3	7314150250769	1	315
BE1FLDS	7314150250783	1	315
BE1FTW	7314150251209	1	315
BE1GP5	7314150170043	1	306
BE1GP5-T	7314150170050	10	307
BE1GP510	7314150207732	1	307
BE1GP512	7314150207749	1	307
BE1GP514	7314150207756	1	307
BE1GP58	7314150207718	1	307
BE1GP59	7314150207725	1	307
BE1P	7314150170067	1	307
BE1SP14L	7314150170074	1	308
BE1SP16L	7314150492756	10	308
BE1SP1F	7314150435777	12	307
BE1T14	7314150167630	1	308
BE1T16	7314150167647	1	308
BE1T21	7314150167654	1	308
BE1TH-10	7314150343980	5	316
BE1TH-12	7314150343997	5	316
BE1TH-14	7314150344000	5	316
BE1TH-2	7314150343874	10	316
BE1TH-2.5	7314150343881	10	316
BE1TH-3	7314150343898	10	316
BE1TH-3.5	7314150343904	10	316
BE1TH-4	7314150343911	10	316



BE1TH-4.5	7314150343928	10	316
BE1TH-5	7314150343935	10	316
BE1TH-6	7314150343942	10	316
BE1TH-7	7314150343959	10	316
BE1TH-8	7314150343966	10	316
BE1TH-9	7314150343973	10	316
BE1TH-S5	7314150457502	1	316
BE1TH-S6	7314150344017	30	316
BE1TS-10	7314150344062	10	316
BE1TS-11	7314150344079	10	316
BE1TS-12	7314150344086	10	316
BE1TS-13	7314150344093	10	316
BE1TS-14	7314150344109	10	316
BE1TS-15	7314150344116	10	316
BE1TS-16	7314150344123	10	316
BE1TS-17	7314150344130	10	316
BE1TS-18	7314150344147	10	316
BE1TS-19	7314150344154	10	316
BE1TS-20	7314150344161	8	316
BE1TS-21	7314150344178	8	316
BE1TS-22	7314150344185	8	316
BE1TS-24	7314150344192	8	316
BE1TS-6	7314150344024	10	316
BE1TS-7	7314150344031	10	316
BE1TS-8	7314150344048	10	316
BE1TS-9	7314150344055	10	316
BE1TS-S7	7314150344208	1	316
BE200CAB250SH10	7314150165452	1	362
BE200CAB250SH25	7314150165469	1	362
BE200CAB250SH3	7314150165445	1	362
BE200CAB40F1	7314150165391	1	362
BE200CAB55F1	7314150165407	1	362
BE200CAB55F3	7314150165414	1	362
BE200CAB58SR1	7314150165421	1	362
BE200CAB58SR3	7314150165438	1	362
BE200CAB80SR1	7314150165384	1	362
BE200CAB80SR3	7314150165476	1	362
BE200MAG4	7314150245192	1	362
BE200MAG55	7314150165513	1	362
BE200MAG80	7314150165551	1	362
BE200MIR4035	7314150245161	1	362
BE200MIR4045	7314150245178	1	362
BE200MIR4055	7314150245185	1	362
BE200MIR5535	7314150165483	1	362
BE200MIR5545	7314150165490	1	362
BE200MIR5555	7314150165506	1	362
BE200MIR8035	7314150165520	1	362
BE200MIR8045	7314150165537	1	362
BE200MIR8055	7314150165544	1	362
BE210	7314150165155	1	362
BE220	7314150170005	1	362
BE230	7314150182633	1	303
BE239	7314150243143	1	303
BE240	7314150239917	1	303
BE240-CAT	7314150289417	1	303
BE250	7314150169924	1	314
BE251	7314150239429	1	314
BE251200	7314150249343	1	334
BE2512005	7314150249350	1	334
BE2512008	7314150249367	1	334
BE253	7314150250806	1	314
BE2541	7314150251797	1	314
BE2542	7314150251803	1	314
BE254A	7314150446070	1	314
BE254A-01	7314150453405	1	314
BE256-155	7314150205875	1	315
BE256-178	7314150205882	1	315
BE256-250	7314150205899	1	315
BE256M	7314150205851	1	314
BE256P3	7314150205868	1	315
BE257	7314150205844	8	304
BE25710	7314150230549	1	304
BE25718	7314150230532	1	304
BE2572	7314150230556	1	304
BE2576	7314150230525	1	304
BE258	7314150251780	1	314
BE301	7314150430871	2	336
BE301CM	7314150430888	50	336
BE301CM-01	7314150430956	20	336
BE301CM-02	7314150430963	20	336
BE310	7314150205943	8	336
BE400P24	7314150205806	1	310
BE400P2401	7314150230600	1	310
BE400P2402	7314150230617	1	310
BE400P2403	7314150230624	1	310
BE400P2404	7314150230631	1	310
BE400P2405	7314150230648	1	311
BE400P2406	7314150230655	1	311
BE400P2407	7314150230662	1	311
BE400P2408	7314150230679	1	311
BE400P2409	7314150230686	1	311
BE400P241	7314150230563	1	310
BE400P2410	7314150230693	1	311
BE400P2411	7314150230709	1	311
BE400P2412	7314150230716	1	311
BE400P2413	7314150230723	1	311



BE400P2414	7314150230730	1	312
BE400P2415	7314150230747	1	312
BE400P2416	7314150230754	1	312
BE400P2417	7314150230761	1	312
BE400P2418	7314150230778	1	312
BE400P2419	7314150230785	1	312
BE400P242	7314150230570	1	310
BE400P2420	7314150237647	1	312
BE400P243	7314150230587	1	310
BE400P244	7314150230594	1	310
BE401	7314150240593	1	309
BE410	7314150205813	4	312
BE4101	7314150230792	1	312
BE5008	7314150239344	1	306
BE5008-10	7314150239269	1	306
BE5008-15	7314150239276	1	306
BE5008-20	7314150239283	1	306
BE5008-25	7314150239290	1	306
BE5008-27	7314150239306	1	306
BE5008-30	7314150239313	1	306
BE5008-40	7314150239320	1	306
BE5008-45	7314150239337	1	306
BE500P24	7314150169955	5	303
BE500P2401	7314150209569	1	303
BE500P2402	7314150209682	1	303
BE500P2403	7314150209736	1	303
BE500P2404	7314150209729	1	303
BE500P2405	7314150209613	1	303
BE500P2406	7314150209804	1	303
BE500P2407	7314150209781	1	303
BE500P2408	7314150209743	1	303
BE500P2409	7314150209750	1	303
BE500P2410	7314150209637	1	303
BE500P2411	7314150209644	1	303
BE500P2412	7314150209699	1	303
BE500P2413	7314150209705	1	303
BE500P2414	7314150209798	1	303
BE500P2415	7314150209675	1	303
BE500P2416	7314150209620	1	303
BE500P2417	7314150209583	1	303
BE500P2418	7314150209576	1	303
BE500P2419	7314150209767	1	303
BE500P2420	7314150209590	1	303
BE500P2421	7314150209606	1	303
BE500P2422	7314150209774	1	303
BE500P2423	7314150209668	1	303
BE500P2424	7314150209712	1	303
BE501101	7314150274499	1	296
BE501102	7314150274505	1	296
BE501203	7314150274529	1	296
BE501204	7314150274536	1	296
BE502101	7314150274543	1	296
BE502102	7314150274550	1	297
BE502103	7314150274567	1	297
BE502104	7314150384952	8	296
BE502106	7314150403370	10	296
BE502204	7314150274574	1	297
BE5032	7314150189885	1	313
BE503201	7314150274581	1	297
BE5032H10EL	7314150220953	1	318
BE5032H14	7314150220960	1	317
BE5032M14	7314150220977	1	317
BE5032SQ10	7314150220991	1	313
BE5032SQ8	7314150220984	1	313
BE5032T55EL	7314150220946	1	318
BE504102	7314150274666	1	297
BE504201	7314150274369	1	297
BE5049	7314150169931	5	317
BE504901	7314150184576	1	317
BE504902	7314150184583	1	318
BE5049H10	7314150184705	1	317
BE5049H10L	7314150184712	1	318
BE5049H12	7314150184729	1	317
BE5049H12L	7314150184736	1	318
BE5049H4	7314150184590	1	317
BE5049H4L	7314150184606	1	318
BE5049H5	7314150184613	1	317
BE5049H5L	7314150184620	1	318
BE5049H6	7314150184637	1	317
BE5049H6L	7314150184651	1	318
BE5049H7	7314150184668	1	317
BE5049H7L	7314150184675	1	318
BE5049H8	7314150184682	1	317
BE5049H8L	7314150184699	1	318
BE5049M10	7314150184804	1	317
BE5049M10L	7314150184811	1	318
BE5049M12	7314150184828	1	317
BE5049M12L	7314150184835	1	318
BE5049M5	7314150184743	1	317
BE5049M5L	7314150184750	1	318
BE5049M6	7314150184767	1	317
BE5049M6L	7314150184774	1	318
BE5049M8	7314150184781	1	317
BE5049M8L	7314150184798	1	318
BE5049T	7314150325474	1	318
BE5049T20	7314150216048	1	317



BE5049T20H



BE5049T20H	7314150184842	1	317
BE5049T20HL	7314150184859	1	318
BE5049T20L	7314150221011	1	318
BE5049T25	7314150216055	1	317
BE5049T25H	7314150184866	1	317
BE5049T25HL	7314150184873	1	318
BE5049T25L	7314150221028	1	318
BE5049T27	7314150216062	1	317
BE5049T27H	7314150184880	1	317
BE5049T27HL	7314150184897	1	318
BE5049T27L	7314150221035	1	318
BE5049T30	7314150216079	1	317
BE5049T30H	7314150184903	1	317
BE5049T30HL	7314150184910	1	318
BE5049T30HXL	7314150184927	1	318
BE5049T30L	7314150221042	1	318
BE5049T40	7314150216086	1	317
BE5049T40H	7314150184934	1	317
BE5049T40HL	7314150184941	1	318
BE5049T40HXL	7314150185092	1	318
BE5049T40L	7314150221059	1	318
BE5049T45	7314150216093	1	317
BE5049T45H	7314150184958	1	317
BE5049T45HL	7314150184965	1	318
BE5049T45HXL	7314150184972	1	318
BE5049T45L	7314150216123	1	318
BE5049T50	7314150216109	1	317
BE5049T50H	7314150184989	1	317
BE5049T50HL	7314150184996	1	318
BE5049T50L	7314150221066	1	318
BE5049T55	7314150216116	1	317
BE5049T55H	7314150185009	1	317
BE5049T55HL	7314150185016	1	318
BE5049T55L	7314150221073	1	318
BE5049T60	7314150221004	1	317
BE5049T60H	7314150185023	1	317
BE5049T60HL	7314150185030	1	318
BE5049T60L	7314150185047	1	318
BE5049T80HL	7314150186532	1	318
BE505101	7314150274598	1	298
BE505102	7314150274604	1	298
BE505203	7314150274611	1	298
BE505204	7314150274628	1	298
BE506101	7314150274376	1	298
BE506102	7314150274635	1	298
BE506103	7314150274642	1	299
BE506204	7314150274659	1	299
BE507101	7314150274673	1	299
BE507102	7314150274680	1	299
BE507203	7314150274697	1	299
BE508101	7314150274765	1	300
BE508202	7314150274772	1	300
BE508203	7314150274703	1	300
BE508204	7314150274710	1	300
BE509101	7314150274727	1	300
BE509102	7314150274734	1	300
BE509103	7314150274383	1	301
BE509104	7314150274741	1	301
BE509205	7314150274390	1	301
BE509206	7314150274406	1	301
BE509207	7314150274758	1	301
BE5100	7314150205646	1	303
BE5101	7314150205721	1	303
BE510101	7314150274420	1	301
BE510102	7314150274437	1	301
BE510125	7314150230877	1	313
BE510127	7314150230884	1	313
BE510130	7314150230891	1	313
BE510140	7314150230907	1	313
BE510145	7314150230914	1	313
BE510150	7314150230921	1	313
BE510155	7314150230938	1	313
BE510160	7314150230945	1	313
BE5102	7314150205738	1	308
BE510203	7314150274789	1	302
BE510210	7314150231003	1	308
BE510211	7314150231010	1	308
BE510212	7314150231027	1	308
BE510213	7314150231034	1	308
BE51025	7314150230952	1	308
BE51026	7314150230969	1	308
BE51027	7314150230976	1	308
BE51028	7314150230983	1	308
BE51029	7314150230990	1	308
BE5103	7314150205745	1	308
BE510304	7314150274444	1	302
BE510310	7314150231072	1	308
BE510312	7314150231089	1	308
BE510314	7314150231096	1	308
BE51035	7314150231041	1	308
BE51036	7314150231058	1	308
BE51038	7314150231065	1	308
BE511101	7314150274451	1	302
BE511102	7314150274468	1	302
BE511203	7314150274796	1	302
BE512201	7314150274475	1	304



BE513201	7314150274802	1	302
BE5150P27	7314150205790	1	313
BE5150P271	7314150230808	1	313
BE5150P272	7314150230815	1	313
BE5150P273	7314150230822	1	313
BE5200	7314150205905	1	317
BE52001	7314150230433	1	317
BE52002	7314150230440	1	317
BE52003	7314150230457	1	317
BE523106	7314150178391	1	302
BE530001	7314150205912	1	317
BE5350	7314150206049	5	306
BE5350C1	7314150230389	1	306
BE5350C2	7314150230396	1	306
BE5350C3	7314150230402	1	306
BE5350C4	7314150230419	1	306
BE5350C5	7314150230426	1	306
BE5400P	7314150245086	1	303
BE5401D	7314150245062	1	303
BE5500	7314150403233	25	315
BE550010	7314150432936	1	315
BE550011	7314150432943	1	315
BE550012	7314150432950	1	315
BE550014	7314150432967	1	315
BE550017	7314150432974	1	315
BE550019	7314150432981	1	315
BE61110	7314150167449	12	319
BE61110-1	7314150167463	100	319
BE61155	7314150167456	12	319
BE61155-1	7314150167470	1	319
BE62110	7314150403332	10	320
BE62155	7314150403349	10	320
BE6217	7314150169702	1	321
BE621701	7314150232642	1	321
BE621702	7314150232659	1	321
BE621703	7314150232666	1	321
BE621704	7314150232673	1	321
BE621705	7314150232680	1	321
BE621706	7314150232697	1	321
BE621707	7314150232703	1	321
BE621708	7314150232710	1	321
BE621709	7314150232727	1	321
BE621710	7314150232734	1	321
BE621711	7314150232741	1	321
BE621712	7314150232758	1	321
BE621713	7314150232765	1	321
BE621714	7314150232772	1	321
BE621715	7314150232789	1	321
BE621716	7314150232796	1	321
BE621717	7314150232802	1	321
BE630	7314150169580	3	320
BE63010015F	7314150232598	25	320
BE63010615F	7314150232604	1	320
BE63010815F	7314150232611	1	320
BE63010818F	7314150232628	1	321
BE630246F	7314150169597	50	320
BE6302712F	7314150412846	5	321
BE630276F	7314150169603	50	320
BE630326F	7314150169610	50	321
BE630366F	7314150169627	100	320
BE630386F	7314150169634	50	321
BE63064514F1	7314150340095	1	321
BE63064514F2	7314150340101	1	321
BE6306514F	7314150232123	12	320
BE630656714F	7314150232130	12	320
BE63066514F	7314150169641	25	321
BE630666F	7314150232116	1	320
BE6306814F	7314150232154	1	320
BE6307314F	7314150232161	1	320
BE6307414F	7314150370108	10	321
BE6307415F	7314150232178	1	320
BE630747615F	7314150232307	12	320
BE630757715F	7314150232321	1	320
BE6307612F	7314150232345	12	320
BE6307614F	7314150232369	12	320
BE6307630F	7314150232437	1	320
BE630768F	7314150232468	1	320
BE6307815F	7314150232475	12	320
BE6308015F	7314150232482	1	320
BE630808215F	7314150232499	1	320
BE6308616F	7314150232505	1	320
BE6308618F	7314150232512	1	320
BE6309015F	7314150232529	1	320
BE6309210F	7314150232536	1	320
BE6309315F	7314150232543	1	320
BE6309336F	7314150232550	1	320
BE6309345F	7314150232567	1	320
BE6309515F	7314150232574	1	320
BE6309618F	7314150232581	1	320
BE64350	7314150169672	1	320
BE64350CH	7314150169696	1	320
BE64520	7314150169665	1	320
BE64520CH	7314150169689	1	320
BE65F65120	7314150169658	12	320
BE65R106160	7314150170036	1	320
BE65R65120	7314150170012	1	320



BE65R80120	7314150170029	1	320
BE66152A	7314150492534	6	320
BE6701VAG	7314150333875	1	321
BE68	7314150237876	1	321
BE6810	7314150237869	1	321
BE6810Z	7314150430765	12	321
BE6FCP	7314150438907	30	315
BE6OF108	7314150434572	50	319
BE6OFW	7314150435784	5	319
BE700	7314150206087	1	312
BE700BP2	7314150206100	1	312
BE700SP15	7314150206094	1	312
BE74-55100	7314150169733	1	309
BE74-57125	7314150169511	1	309
BE74-57125L	7314150169535	1	309
BE74-80120	7314150169740	1	309
BE74-90175	7314150169528	1	309
BE76101	7314150240005	1	305
BE762	7314150384983	12	305
BE800P12	7314150205677	1	313
BELMS12OBDL	7314150340323	8	337
BELP1224	7314150177882	1	341
BELS12	7314150170579	1	340
BELT10	7314150170623	1	319
BELT1213A	7314150493104	20	340
BELT127	7314150177899	1	340
BELT2415A	7314150493098	20	340
BELT247N	7314150170586	1	340
BELT247S	7314150170593	1	340
BELTKEY	7314150177875	1	339
BELTRP16	7314150169917	1	340
BELTRP1601	7314150231935	1	340
BELTRP1602	7314150231942	1	340
BELTRP1603	7314150231959	1	340
BELTRP1604	7314150231966	1	340
BELTRP1605	7314150231973	1	340
BELTRP1606	7314150231980	1	340
BELTRP1607	7314150231997	1	340
BELTRP1608	7314150232000	1	340
BELTRP1609	7314150232017	1	340
BELTRP1610	7314150232024	1	340
BELTRP1611	7314150232031	1	340
BELTRP1612	7314150232048	1	340
BELTRP1613	7314150232062	1	340
BELTRP1614	7314150232079	1	340
BELTRP1615	7314150232086	1	340
BELTRP1616	7314150232093	1	340
BFRL11	7314150306534	1	360
BGIS125	7314150416431	20	340
BH110000A-02	7314150273669	1	352
BH110000A-04	7314150273683	1	352
BH110000A-EXT	7314150291946	1	352
BH110000B	7314150516414	1	352
BH11500	7314150178797	1	351
BH11500-01	7314150182220	1	357
BH11500-02	7314150182237	1	352
BH11500-04	7314150182275	1	352
BH12000	7314150178803	1	351
BH13000	7314150178810	1	351
BH13000-02	7314150182244	1	352
BH13000L	7314150301980	1	352
BH13000L-01	7314150301997	1	357
BH13000QA	7314150403295	1	352
BH15000A-01	7314150273515	1	357
BH15000A-02	7314150273522	1	352
BH15000A-04	7314150273546	1	352
BH15000A-EXT	7314150291939	1	352
BH15000B	7314150516407	1	352
BH1A1500-04	7314150265299	1	357
BH1A1500A	7314150460946	1	351
BH1A1500A-05	7314150477302	40	352
BH1A2500-03	7314150226856	1	352
BH1A2500-04	7314150226863	1	357
BH1A2500A	7314150460953	1	351
BH1CB1000	7314150243204	1	352
BH1CD680	7314150330379	1	355
BH1CD680ST	7314150330386	1	355
BH1EU3000	7314150245000	1	351
BH1EU3000-01	7314150250004	1	352
BH1EU3000-03	7314150249893	1	352
BH1EU3000-08	7314150249947	1	357
BH1M1000	7314150237845	1	351
BH1S45	7314150292295	1	352
BH1S45-01	7314150311194	1	357
BH1S45-03	7314150311217	1	352
BH230	7314150264070	1	353
BH23015	7314150178759	1	353
BH23015C	7314150178742	1	353
BH2402010	7314150178766	1	353
BH2604020	7314150178773	1	354
BH28050	7314150472222	1	354
BH2AC1	7314150213474	1	354
BH2AC2	7314150213481	1	354
BH2AC60-140	7314150168958	1	354
BH2AC60V110	7314150178933	1	354
BH33000	7314150178674	1	354



BH36000	7314150178681	1	354
BH3A10000	7314150234660	1	354
BH3A3000	7314150234646	1	354
BH3A5000	7314150234653	1	354
BH3AL2500	7314150302420	1	354
BH3HD12000	7314150170500	1	355
BH3HD16000	7314150170524	1	355
BH3HD20000A	7314150337668	1	355
BH3HD8000	7314150170494	2	354
BH3SQ15000	7314150234684	2	354
BH3SQ7000	7314150234677	2	354
BH410	7314150178711	1	351
BH415	7314150178728	2	351
BH42	7314150178698	1	350
BH420	7314150178735	1	351
BH430	7314150178780	2	351
BH45	7314150178704	1	350
BH4HP50	7314150477081	1	351
BH4S12	7314150237920	3	350
BH4S2	7314150237883	6	350
BH4S20	7314150237937	1	350
BH4S4	7314150237890	6	350
BH4S50	7314150476879	1	350
BH4S6	7314150237906	4	350
BH4S8	7314150237913	4	350
BH5DP1000QA	7314150270224	1	355
BH5SP500QA	7314150270217	1	355
BH5US1000	7314150243174	1	355
BH6AC1-680A	7314150433544	1	356
BH6FC1000	7314150178650	1	356
BH6FC2000	7314150234639	1	356
BH6PC600	7314150234622	1	356
BH7100A	7314150345908	1	342
BH7100SG	7314150299782	1	343
BH715	7314150237555	1	342
BH715-13	7314150239191	1	342
BH720	7314150235650	1	342
BH720-22	7314150236961	1	342
BH720SG	7314150238477	1	342
BH730	7314150235667	1	342
BH730SG	7314150238484	1	342
BH750	7314150235674	1	342
BH750SG	7314150238491	1	342
BH7PS30	7314150474882	2	342
BH8AC1-500	7314150170463	1	313
BH8AC2-500	7314150412532	1	313
BH8AC3-1500	7314150292264	1	356
BH8AC3-1500A	7314150516391	1	356
BH8AC3-600	7314150351893	1	355
BH8BC1	7314150242276	1	350
BH8BC2	7314150242283	1	350
BH8BC3	7314150242290	10	350
BH8BC4	7314150242306	6	350
BH8BC5	7314150242313	6	350
BH8PR10000	7314150178957	1	350
BH8PR4000	7314150178940	1	350
BH9BJ22SLH	7314150246946	1	353
BH9BJ22SSH	7314150247462	1	353
BH9BJ23SLH	7314150246953	1	353
BH9BJ23SSH	7314150246960	1	353
BH9BJ260	7314150247509	1	353
BH9BJ280	7314150247516	1	353
BHVIG15-250	7314150403745	12	357
BHVIS06100	7314150167753	1	332
BHVIS06105	7314150167760	1	332
BHVIS0670	7314150167692	1	332
BHVIS0677	7314150167708	1	332
BHVIS0680	7314150167715	1	332
BHVIS0685	7314150167722	1	332
BHVIS0690	7314150167739	1	332
BHVIS0695	7314150167746	1	332
BHVIS08100	7314150165711	1	332
BHVIS08115	7314150165728	1	332
BHVIS0895	7314150165704	1	332
BHVIS109BPW12	7314150165759	1	332
BHVIS111BPW12	7314150165735	1	333
BHVIS120BPW16	7314150165742	1	332
BHVIS1265	7314150167685	1	332
BHVIS80BPW12	7314150165766	1	333
BHVIS95BPW9	7314150243334	1	333
BKE850901N	7314150449705	10	229
BLBT100	7314150179015	1	344
BLBT100AC1	7314150179022	1	344
BLCR230FR	7314150247356	1	360
BLCR230SC	7314150247349	1	360
BLCR24VCL	7314150247370	1	360
BLCR24VLL	7314150247387	1	360
BLCR400E	7314150247363	1	360
BLCRSC1	7314150247530	1	360
BLCRSC2	7314150247547	1	360
BLE300	7314150227648	1	343
BLE301	7314150227662	1	344
BLE302	7314150227679	1	344
BLE304	7314150249572	1	344
BLE305	7314150339341	1	343
BLEMAT1	7314150477678	1	343



BLEMAT1BT



BLEMAT1BT	7314150477685	1	343
BLS128	7314150246847	20	360
BLT550	7314150243556	10	304
BLTFC1	7314150246434	20	360
BLTS10	7314150246427	20	360
BLTS7P	7314150246410	58	360
BLUVF	7314150247622	1	304
BMD150	7314150242238	1	343
BMMTRMS1	7314150274024	1	339
BMR240	7314150242245	1	343
BMVAT1000	7314150488360	50	339
BOD101	7314150205967	1	322
BOD1016	7314150169979	1	324
BOD101NWS	7314150269099	1	322
BOD101T	7314150269150	1	324
BOD102	7314150205974	1	322
BOD102NWS	7314150269105	1	322
BOD102T	7314150269167	1	324
BOD103	7314150205981	1	322
BOD103NWS	7314150269112	1	322
BOD103T	7314150269174	1	324
BOD104	7314150205998	1	322
BOD104NWS	7314150269129	1	322
BOD104T	7314150269181	1	324
BOD105	7314150206001	1	322
BOD105NWS	7314150269136	1	322
BOD105T	7314150269198	1	324
BOD106	7314150206018	1	322
BOD106NWS	7314150269143	1	322
BOD106T	7314150269204	1	324
BOD10P64	7314150205950	1	322
BOD2008	7314150169986	1	324
BOD2FS	7314150351879	20	324
BOD301200	7314150169993	1	324
BOD4200	7314150169436	1	323
BOD4500	7314150169443	1	323
BOD54-1	7314150239467	1	325
BOD54-2	7314150239474	1	325
BOD54-3	7314150239481	1	325
BOD5400	7314150169450	1	324
BOD5450	7314150169474	1	324
BOD5HD400	7314150169467	1	324
BOD60	7314150169481	1	324
BOD6080P12	7314150235407	1	322
BOD6080P12-01	7314150235438	1	323
BOD6080P12-02	7314150235445	1	323
BOD6080P12-03	7314150235452	1	323
BOD6080P12-04	7314150235469	1	323
BOD6080P12-05	7314150235476	1	323
BOD6080P12-06	7314150235490	1	323
BOD6080P12-07	7314150235506	1	323
BOD6080P12-08	7314150235513	1	323
BOD6080P12-09	7314150235520	1	323
BOD6080P12-10	7314150235537	1	323
BOD6080P12-11	7314150235544	1	323
BOD70	7314150169498	1	324
BOD8901	7314150169016	1	322
BOD8901AC1	7314150178490	1	322
BOD8902	7314150169023	1	322
BOD8903A	7314150265374	1	322
BP-40	7314150453085	1	587
BP-40-95	7314150487097	12	587
BP110	7314150135011	1	279
BP111E	7314150235872	12	279
BP115	7314150134991	1	277
BP117	7314150184309	1	277
BP117EH	7314150184316	1	279
BP118	7314150235834	1	277
BP125A	7314150427291	6	285
BP127	7314150137565	1	279
BP12718	8414909179002	1	280
BP127P	7314150427277	1	279
BP204	7314150184286	1	281
BP20410320	7314150185948	1	281
BP20410800	7314150185955	1	281
BP20425180	7314150185924	1	281
BP20425220	7314150185931	1	281
BP204K	7314150184293	1	281
BP204PAD	7314150185917	1	281
BP212	7314150134601	1	281
BP215A	7314150341849	10	285
BP218	7314150170272	1	286
BP219	7314150235889	1	286
BP219L	7314150235896	1	286
BP219V	7314150307197	1	286
BP219XL	7314150427192	10	286
BP222	7314150137572	1	281
BP233	7314150134748	1	283
BP254	7314150137633	1	286
BP255	7314150137640	1	287
BP255T	7314150427307	1	287
BP255T-1	7314150427314	1	287
BP277K	7314150427284	8	285
BP420M	7314150134618	1	278
BP421M	7314150134625	1	278
BP422M	7314150134632	1	278



BP423M	7314150134649	1	278
BP424M	7314150134656	1	278
BP430M	7314150134663	1	278
BP431M	7314150134670	1	278
BP432M	7314150134687	1	279
BP433M	7314150134694	1	279
BP434M	7314150135837	1	279
BP500	7314150137992	1	286
BP51137	7314150134724	1	281
BP601	7314150134526	1	281
BP60102	7314150426669	1	281
BP610	7314150134595	1	282
BP700	7314150134458	20	277
BP704	7314150427130	1	274
BP721	7314150427185	1	277
BP799	7314150134502	1	285
BP79912	7314150134717	1	285
BP809	7314150235841	1	282
BP80950	7314150275564	1	282
BP810	7314150235858	1	282
BP811	7314150235865	1	284
BP814	7314150184262	10	274
BP814A	7314150304349	10	274
BP815	7314150134311	1	274
BP815K1	7314150181957	1	274
BP815K2	7314150181964	1	274
BP817	7314150134106	1	275
BP820	7314150134465	1	277
BP821	7314150134472	1	277
BP822	7314150134984	1	278
BP822E	7314150184279	10	278
BP823	7314150135004	1	279
BP824	7314150134489	1	283
BP825	7314150134496	1	282
BP826	7314150137459	1	283
BP827	7314150137442	1	283
BP828	7314150427260	1	283
BP830CISB	7314150439799	1	280
BP830ESB	7314150439751	1	280
BP830EWB	7314150439768	1	280
BP830K	7314150427208	4	280
BP830MISB	7314150439782	1	280
BP830SBA	7314150439805	1	280
BP830SSB	7314150439775	1	280
BP830SW	7314150439744	1	280
BP901	7314150336012	1	276
BP901L	7314150336029	1	276
BP905L	7314150336234	2	276
BP905P	7314150336210	2	276
BP905S	7314150336227	2	276
BP909NE	7314150187980	1	285
BP909NF	7314150187973	1	285
BP909TE	7314150187942	1	284
BP909TF	7314150187911	1	284
BP909TH	7314150187959	1	284
BP909TSP	7314150187966	1	285
BP909TTP	7314150187935	1	284
BP909TWF	7314150187928	1	284
BP910	7314150427246	5	284
BP91BL	7314150192779	1	277
BP91BS	7314150192786	1	277
BPA823	7314150427161	1	282
BPBG3515	7314150134823	1	283
BPBG3525A	7314150134830	1	283
BPBG3525B	7314150134847	1	283
BPBG5725	7314150134861	1	284
BPBG9057	7314150134878	1	284
BPBK30	7314150134854	1	283
BPBL00900	7314150358335	5	345
BPBL30900	7314150360451	5	345
BPBL70600	7314150360468	5	345
BPBL90600	7314150358366	5	345
BPBLS4	7314150360475	2	345
BPBSC156	7314150134816	1	283
BPBU18	7314150134755	1	284
BPBU24	7314150134762	1	284
BPBU36	7314150134779	1	284
BPBU60	7314150134786	1	284
BPBU90	7314150134793	1	284
BPC813	7314150296408	10	274
BPC813K1	7314150331253	1	274
BPC814	7314150296392	10	275
BPC815	7314150296385	1	275
BPC815K1	7314150331208	1	275
BPC815K2	7314150331215	1	275
BPC815K3	7314150331222	1	275
BPC815K4	7314150331239	1	275
BPC815K6	7314150331284	1	275
BPC816	7314150296415	10	274
BPC817	7314150296422	4	275
BPC817K1	7314150331260	1	276
BPC817K2	7314150331277	1	276
BPC823	7314150427147	1	282
BPC825	7314150427154	1	282
BPVCB1	7314150384792	6	334
BPG824	7314150427253	10	283



BPH1010A	7314150330010	1	287
BPH1010B	7314150341757	1	287
BPH1310A	7314150330003	1	287
BPHRC1015	7314150247400	1	287
BPHRC1020	7314150247417	1	287
BPHRC1316	7314150247455	1	287
BPHRC815	7314150247394	1	287
BPHRO1315	7314150247431	1	288
BPHRSC	7314150247448	1	287
BPHVLP01	7314150138937	1	285
BPHVLP0112	7314150165872	1	286
BPHVLP0114	7314150165889	1	286
BPHVLP0117	7314150165896	1	286
BPHVLP0120	7314150165902	1	286
BPM917BOOT	7314150281664	1	276
BPM91MK1	7314150186938	1	276
BPM91MK2	7314150186945	1	276
BPN010	7314150219728	1	286
BPN21201	7314150134731	1	282
BPN22201	7314150138074	1	282
BPN251	7314150137589	1	287
BPOC15	7314150360673	12	315
BPQCF14	7314150138920	10	288
BPR821	7314150427178	1	277
BPSJ	7314150427239	1	288
BPSJL	7314150439812	1	288
BS1000	7314150170081	1	337
BS100001	7314150232819	1	337
BS100002	7314150232826	1	337
BS100003	7314150232833	1	337
BS100004	7314150232840	1	337
BS100005	7314150232857	1	337
BS100006	7314150232864	1	337
BS100007	7314150232871	1	337
BS100008	7314150232888	1	337
BS100009	7314150232895	1	337
BS100010	7314150232901	1	337
BS100011	7314150232918	1	337
BS100012	7314150232925	1	337
BS100013	7314150232932	1	337
BS100014	7314150232949	1	337
BS100015	7314150232956	1	337
BS100016	7314150232963	1	337
BS100017	7314150232970	1	337
BS100018	7314150232987	1	337
BS100019	7314150232994	1	337
BS100020	7314150233007	1	337
BS100021	7314150233014	1	337
BS100022	7314150233021	1	337
BS100023	7314150233038	1	337
BS100024	7314150233045	1	337
BS100025	7314150233052	1	337
BS100026	7314150233069	1	337
BS100027	7314150233076	1	337
BS100028	7314150233083	1	337
BS100029	7314150233090	1	337
BS100030	7314150233106	1	337
BS100031	7314150233113	1	337
BS100032	7314150233120	1	337
BS100033	7314150233137	1	337
BS100034	7314150233144	1	337
BS100035	7314150233151	1	337
BS100036	7314150233168	1	337
BS100037	7314150233175	1	337
BS100038	7314150233182	1	337
BS100039	7314150233199	1	337
BS100PSA1	7314150249282	1	335
BS10AC2	7314150182343	1	336
BS15	7314150206117	1	336
BS15125	7314150231775	1	336
BS15125C	7314150231812	1	336
BS15160	7314150231782	1	336
BS15160C	7314150231829	1	336
BS15212	7314150231799	1	336
BS15212C	7314150231836	1	336
BS1550	7314150231805	1	336
BS25	7314150416103	1	336
BS30AC1	7314150383504	1	337
BS30PG	7314150436644	1	336
BS40VAG	7314150430642	20	335
BS45BMW	7314150430659	20	335
BS52	7314150329212	1	334
BS5228341	7314150329229	1	334
BS5234401	7314150329236	1	334
BS5239451	7314150329243	1	334
BS54	7314150243341	1	334
BS56	7314150430826	6	334
BS618	7314150242368	1	335
BS623	7314150242375	1	335
BSSHE3	7314150251858	1	333
BT10P3	7314150205639	1	344
BT10P325	7314150231706	40	345
BT10P330	7314150231713	1	345
BT10P338	7314150231720	1	345
BT15P5	7314150205837	1	332
BT15P524	7314150231737	1	332



BT15P530	7314150231744	1	332
BT15P532	7314150231751	1	332
BT15P536	7314150342129	1	332
BT20P26	7314150205820	1	335
BT20P49	7314150385041	1	335
BTL-3-13	7314150333349	12	552
BTL-6-13	7314150333356	12	552
BTR-3-13	7314150333332	12	552
BTR-6-13	7314150333363	12	552
BUC100	7314150169962	1	319
BUC110	7314150206025	1	319
BUC50	7314150182329	1	319
BUCKET 1446	7314150436446	75	599
BUCPE	7314150243259	1	318
BUCPE3SDH	7314153024183	1	319
BUCPE3SH	7314150243471	1	318
BUCPEF	7314150244942	1	318
BUCPEF1	7314150245116	1	318
BWB14	7314150170166	2	335
BWB1418S4	7314150365593	6	343
BWB1922S4	7314150365609	6	343
BWBB	7314150407828	200	331
BWC1	7314150365586	25	331
BWHEHS	7314150251841	1	333
BWHEP	7314150251834	1	333
BWHEPS	7314150264087	1	333
BWHEPSH8	7314150264889	1	333
BWHEPSSH8	7314150264896	1	333
BWHPJ12	7314150403257	4	335
BWHTRS12	7314150384808	15	331
BWMSP15	7314150239740	1	371
BWMSP1501	7314150239757	1	371
BWMSP1502	7314150239764	1	371
BWMSP1503	7314150239771	1	371
BWMSP1504	7314150239788	1	371
BWMSP1505	7314150239795	1	371
BWMSP1506	7314150239801	1	371
BWMSP1507	7314153024176	1	371
BWMSP1508	7314150239818	1	371
BWMSP1509	7314150239825	1	371
BWMSP1510	7314150239832	1	371
BWMSP1511	7314150239849	1	371
BWMSP1512	7314150239856	1	371
BWMSP1513	7314150239863	1	371
BWMSP1514	7314150239870	1	371
BWMSP1515	7314150239887	1	371
BWP150	7314150170159	1	331
BWSH5	7314150251810	2	333
BWSH51	7314150251827	1	334
BWSH8	7314150255191	1	333
BWSHK21	7314150403271	25	329
BWSMB15	7314150365074	25	329
BWSMB17	7314150329656	1	329
BWSS12P3	7314150170128	20	328
BWSS12P317	7314150203451	1	329
BWSS12P317L	7314150330065	1	329
BWSS12P319	7314150203468	1	329
BWSS12P319L	7314150330072	1	329
BWSS12P321	7314150203475	1	329
BWSS12P321L	7314150330089	1	329
BWSS12P3L	7314150330096	1	329
BWSS12P5	7314150170135	1	329
BWSS12P522	7314150203482	1	329
BWSS12P524	7314150203499	1	329
BWBT12P100	7314150329830	1	330
BWBT12P110	7314150329847	1	330
BWBT12P120	7314150329854	1	330
BWBT12P135	7314150329861	1	330
BWBT12P150	7314150329878	1	330
BWBT12P160	7314150329885	1	330
BWBT12P175	7314150329892	1	330
BWBT12P190	7314150329908	1	330
BWBT12P200	7314150329915	1	330
BWBT12P5	7314150329991	1	330
BWBT12P90	7314150329823	1	330
BWTDG1	7314150403400	50	332
BWTPG1	7314150351886	10	332
BWTPMSS4C	7314150347100	25	332
BWTPMSS9	7314150347124	8	332
BWTSP16	7314150170296	1	330
BWTSP1608	7314150203284	1	330
BWTSP1610	7314150203291	1	330
BWTSP1611	7314150203307	1	330
BWTSP1612	7314150203314	1	330
BWTSP1613	7314150203321	1	330
BWTSP1614	7314150203338	1	330
BWTSP1616	7314150203345	1	330
BWTSP1617	7314150203352	1	330
BWTSP1618	7314150203369	1	330
BWTSP1619	7314150203376	1	330
BWTSP1621	7314150203383	1	330
BWTSP1622	7314150203390	1	330
BWTSP1624	7314150203406	1	330
BWTSP1627	7314150203413	1	330
BWTSPP317L	7314150335480	1	329
BWTSPP319L	7314150335497	1	329



BWTSP321L



BWTSP321L	7314150335503	1	329
BWTSP3L	7314150335473	1	329
BWTSP6	7314150240043	1	330
BWTSP617	7314150242399	1	330
BWTSP619	7314150242405	1	330
BWTSP621	7314150242412	1	330
BWTSP622	7314150242429	1	330
BWTSP624	7314150242436	1	330
BWTSP7	7314150170302	1	330
BWTSP732	7314150203420	1	330
BWTSP736	7314150203437	1	330
BWTSP741	7314150203444	1	330
BWTVCTT355	7314150347179	1	332
BWXW1	7314150167661	1	328
BWXW2	7314150167678	1	328
BWXW3	7314150214624	1	328
BWXW4	7314150214631	1	328
BZWTB0132450	7314150165674	1	331
BZWTB0132600	7314150165681	1	331
BZWTB0133600	7314150165698	1	331
C0312I03	7314150501298	5	147
C0313M03	7311518100636	1	144
C0313M03X	7311518182045	1	144
C0616AL06	7311518181826	1	145
C0616M03X	7311518204679	1	144
C0616M06	7311518100667	1	144
C0616M06X	7311518100681	1	144
C0618I06	7314150501311	5	147
C0618S06	7314150501342	5	146
C0820M06	7311518100711	1	144
C0820M06X	7311518100735	1	144
C1020I06	7314150501373	5	147
C1020M06	7311518100766	1	144
C1020M06X	7311518100780	1	144
C1020S06	7314150501403	5	146
C1225AL06	7311518187637	1	145
C1225I06	7314150506743	5	147
C1225M06	7311518100810	1	144
C1225M06X	7311518100834	1	144
C1225M08X	7311518187996	1	144
C1225S06	7314150501465	5	146
C1625M06	7311518192266	1	144
C1625M06X	7311518187378	1	144
C1625M08	7311518100902	1	144
C1625M08X	7311518100926	1	144
C1997LM/9P	7314150510375	1	225
C1997TORX/9P	7314150510382	1	226
C3140	7314150393312	10	234
C3140IP	7314150391158	10	234
C3230	7314150393329	10	237
C3230IP	7314150391189	10	237
C3330	7314150393336	10	234
C3330IP	7314150391196	10	234
C3330R	7314150393343	10	234
C3330R IP	7314150391202	10	234
C3340R	7314150393350	10	234
C3340R IP	7314150391219	10	234
C3430	7314150393367	10	245
C3430IP	7314150391226	10	245
C3530	7314150393374	10	246
C3530IP	7314150391233	10	246
C3630	7314150393381	10	242
C3630IP	7314150391240	10	242
C3640	7314150393398	10	242
C3640IP	7314150391257	10	242
C3745	7314150393404	10	243
C3745IP	7314150391264	10	243
C3790	7314150393411	10	243
C3790IP	7314150391271	10	243
C3830	7314150393428	10	242
C3830IP	7314150391288	10	242
C3840	7314150393435	10	242
C3840IP	7314150391295	10	242
C3901/3	7314150392797	1	257
C3902/3	7314150399604	1	257
C3903/2-6	7314150466481	1	258
CFP250	7314150400669	6	626
CFP250-DISP	7314150400690	12	626
CFW250	7314150400683	6	626
CFW250-DISP	7314150400706	12	626
CHALK-BLUE	7314150128686	6	556
CHALK-RED	7314150128709	6	556
CHALK-WHITE	7314150179671	6	556
CHALK-YELLOW	7314150128693	6	556
CL-1221	7314150127122	6	556
CL-1221-SET	7314150188574	4	556
CL-1331	7314150347728	48	556
CL-1441	7314150347735	36	556
CLIPS-1/2	7314153003201	25	96
CLIPS-1/4	7314153003188	25	84
CLIPS-3/8	7314153003195	25	90
CR B 01	7314150215409	10	254
CR B 02	7314150215416	10	254
CR B 03	7314150215423	5	254
CR B 05	7314150215454	2	254
CR B 06	7314150215461	2	254



CR L 01	7314150215911	1	256
CR L 02	7314150215928	1	256
CR L 03	7314150215935	1	257
CR OV 01	7314150489978	1	255
CR SA H01	7314150489992	1	256
CR SA H16	7314150508990	1	256
CR SA S01	7314150490011	1	256
CR SA T01	7314150490035	1	256
CR W 01	7314150215492	1	255
CR W 02	7314150215508	1	255
CR W 03	7314150215515	1	255
CR W 04	7314150215522	1	255
CR W 05	7314150215539	1	255
CR W 06	7314150215546	1	256
CS-SPARE	7314150453030	1	558
CS150	7314150125241	12	558
CS300	7314150125258	12	558
CS400	7314150125265	12	558
CUC-0.4-360	7314150342075	4	614
CUC-0.8-600	7314150342099	4	614
D-DD/S20	7311518280345	4	178
D/S10	7311518280307	6	179
D/S14	7311518280314	6	179
D0303I03	7314150501281	5	147
D0303M03	7311518100957	1	144
D0303M03X	7311518182052	1	144
D0605M03X	7311518197896	1	144
D0606I06	7314150501328	5	147
D0606M06	7311518100988	1	144
D0606M06X	7311518101008	1	144
D0606S06	7314150501359	5	146
D0807M06	7311518043896	1	144
D0807M06X	7311518043919	1	144
D1009M06	7311518035280	1	144
D1009M06X	7311518035297	1	144
D1010I06	7314150501380	5	147
D1010S06	7314150501410	5	146
D1211AL06	7311518187644	1	146
D1211AL08	7311518181840	1	146
D1211M06	7311518035334	1	144
D1211M06X	7311518035358	1	144
D1212I06	7314150501441	5	147
D1212S06	7314150501472	5	146
D1614M06	7311518192327	1	144
D1614M06X	7311518187385	1	144
D1614M08	7311518035389	1	144
D1614M08X	7311518035402	1	144
DD/S10	7311518280321	6	179
DD/S14	7311518280338	4	178
DOW 175-1	7314152202728	1	266
DOW 175-11/2	7314152202995	1	266
DOW 175-2	7314152203022	1	266
DOW 175-3	7314152203299	1	266
DOW 176-1	7314152206047	1	267
DOW 176-11/2	7314152206122	1	267
DOW 176-2	7314152206399	1	267
DOW 177-1/2-1	7314152816383	1	266
DOW 177-11/2	7314152816468	1	266
DOW 177-2	7314152816543	1	266
E0308M03	7311518035433	1	144
E0308M03X	7311518192372	1	144
E0614M06	7311518035464	1	144
E0816M06	7311518035518	1	144
E0816M06X	7311518035532	1	144
E1015I06	7314150501496	5	147
E1018M06	7311518035563	1	144
E1018M06X	7311518035587	1	144
E1220I06	7314150501526	5	147
E1222M06	7311518035617	1	144
E1222M06X	7311518035631	1	144
E1222M08	7311518172558	1	144
E1222M08X	7311518199302	1	144
E1625M06	7311518192440	1	144
E1625M06X	7311518187392	1	144
E1625M08	7311518035709	1	144
E1625M08X	7311518035723	1	144
EX-14-TEN-C	7311518298333	10	577
EX-14-VEN-C	7311518298340	10	577
EX-16-GNP-C	7311518298685	10	574
EX-19-XT9-C	7311518298302	10	576
EX-20-LAM-C	7311518298326	10	577
EX-20-XT11-C	7311518298319	10	577
EX-22-PLS-C	7311518298357	10	574
EX-22-U7	7311518300890	10	576
EX-22-XT7-C	7311518298289	10	578
EX-22-XT9-C	7311518298296	10	576
EX-24-XT7-C	7311518298272	10	578
EX-24P-22	7311518298456	10	578
EX-LL	7311518298494	4	580
EX-NPP-22	7311518324162	10	576
EX-RL	7311518298487	4	580
EX-RM	7311518298470	4	580
F0312I03	7314150501502	5	147
F0313M03	7311518035754	1	144
F0313M03X	7311518192495	1	144
F0613M03X	7311518196608	1	144



F0618AL06	7311518181857	1	146
F0618I06	7314150501533	5	147
F0618M06	7311518035792	1	144
F0618M06X	7311518035815	1	144
F0618S06	7314150501564	5	146
F0820M06	7311518035839	1	144
F0820M06X	7311518035860	1	144
F1020I06	7314150501595	5	147
F1020M06	7311518035891	1	144
F1020M06X	7311518035914	1	144
F1020S06	7314150501625	5	146
F1225AL06	7311518187651	1	146
F1225AL08	7311518181864	1	146
F1225I06	7314150501656	5	147
F1225M06	7311518035945	1	144
F1225M06X	7311518036003	1	144
F1225M08	7311518035983	1	144
F1225M08X	7311518192563	1	144
F1225S06	7314150501687	5	146
F1625M06	7311518192570	1	144
F1625M06X	7311518187408	1	144
F1625M08	7311518036034	1	144
FCP-1.8-810	7311518123970	614	614
FCP-2.3-860	7311518123994	2	614
FCS-1000	7314150321551	6	559
FCS-600	7314150321537	6	559
FCS-800	7314150321544	6	559
FF1A01	7314150228560	1	405
FF1A02	7314150228591	1	414
FF1A03	7314150228607	1	420
FF1A04	7314150227778	1	414
FF1A051	7314150478446	1	405
FF1A06	7314150227822	1	420
FF1A07	7314150227846	1	421
FF1A08	7314150227976	1	406
FF1A09	7314150227990	1	414
FF1A10	7314150228010	1	402
FF1A1001	7314150286478	1	402
FF1A1002	7314150286461	1	403
FF1A1003	7314150286485	1	403
FF1A1004	7314150286454	1	412
FF1A1005	7314150286591	1	403
FF1A1006	7314150286645	1	403
FF1A1007	7314150286621	1	403
FF1A1008	7314150309443	1	403
FF1A1010	7314150320660	1	412
FF1A1011	7314150339068	1	413
FF1A102	7314150334841	1	418
FF1A104	7314150334865	1	414
FF1A106	7314150335541	1	406
FF1A11	7314150228034	1	418
FF1A110	7314150335619	1	421
FF1A112	7314150335572	1	414
FF1A114	7314150335633	1	421
FF1A115	7314150335640	1	421
FF1A117	7314150335701	1	421
FF1A118	7314150335732	1	418
FF1A119	7314150335749	1	421
FF1A12	7314150228058	1	422
FF1A121	7314150335718	1	422
FF1A124	7314150335725	1	422
FF1A127	7314150336395	1	422
FF1A128	7314150336586	1	423
FF1A129	7314150336593	1	423
FF1A13	7314150228072	1	406
FF1A130	7314150336661	1	406
FF1A131	7314150336678	1	423
FF1A132	7314150336685	1	423
FF1A133	7314150336692	1	413
FF1A134	7314150336708	1	415
FF1A135	7314150336715	1	415
FF1A136	7314150336722	1	423
FF1A137	7314150336739	1	407
FF1A138	7314150336746	1	424
FF1A139	7314150336753	1	413
FF1A14	7314150228089	1	415
FF1A141	7314150336777	1	418
FF1A142	7314150338573	1	407
FF1A143	7314150338580	1	424
FF1A145	7314150338603	1	419
FF1A146	7314150338610	1	407
FF1A147	7314150338627	1	424
FF1A15	7314150228096	1	419
FF1A153	7314150350445	1	410
FF1A154	7314150350476	1	430
FF1A16	7314150228102	1	424
FF1A164	7314150350957	1	430
FF1A165	7314150350964	1	411
FF1A166	7314150350971	1	405
FF1A167	7314150350988	1	430
FF1A168	7314150350995	1	430
FF1A169	7314150351008	1	430
FF1A17	7314150228119	1	404
FF1A170	7314150351800	1	418
FF1A18	7314150228126	1	424
FF1A185	7314150358694	1	422



FF1A189	7314150405961	1	431
FF1A19	7314150254354	1	415
FF1A194	7314150431496	1	411
FF1A195LM	7314150455850	1	411
FF1A196LM	7314150455874	1	411
FF1A197LM	7314150455881	1	431
FF1A198LM	7314150455898	1	417
FF1A199LM	7314150455904	1	417
FF1A20	7314150254361	1	415
FF1A200LM	7314150455928	1	420
FF1A201LM	7314150455935	1	405
FF1A202LM	7314150455966	1	413
FF1A203LM	7314150455973	1	413
FF1A204LM	7314150455980	1	431
FF1A205LM	7314150455997	1	431
FF1A206LM	7314150456000	1	411
FF1A207LM	7314150456017	1	411
FF1A208LM	7314150456024	1	431
FF1A209LM	7314150456031	1	417
FF1A21	7314150254378	1	404
FF1A210LM	7314150456062	1	431
FF1A211LM	7314150456079	1	414
FF1A212LM	7314150456086	1	432
FF1A213	7314150437283	1	412
FF1A214LM	7314150456093	1	412
FF1A215LM	7314150456109	1	432
FF1A216LM	7314150456123	1	432
FF1A218LM	7314150456130	1	412
FF1A219LM	7314150456147	1	412
FF1A22	7314150254385	1	407
FF1A220LM	7314150456154	1	417
FF1A221LM	7314150456161	1	432
FF1A222LM	7314150456178	1	432
FF1A223LM	7314150456185	1	420
FF1A224LM	7314150456192	1	432
FF1A225LM	7314150456208	1	433
FF1A23	7314150254392	1	424
FF1A230	7314150461455	1	433
FF1A2301	7314150286508	1	408
FF1A235	7314150500666	1	418
FF1A236	7314150500680	1	422
FF1A24	7314150254408	1	425
FF1A25	7314150254415	1	408
FF1A2501	7314150286492	1	408
FF1A2503	7314150320677	1	408
FF1A26	7314150254422	1	425
FF1A27	7314150254439	1	404
FF1A28	7314150254446	1	425
FF1A29NB	7314150266340	1	433
FF1A3001	7314150286515	1	415
FF1A3002	7314150289264	1	416
FF1A3003	7314150286522	1	416
FF1A3004	7314150286676	1	416
FF1A3005	7314150286638	1	416
FF1A30NB	7314150266357	1	433
FF1A31NB	7314150266364	1	433
FF1A35	7314150264124	1	425
FF1A36	7314150265862	1	425
FF1A37	7314150265855	1	409
FF1A39	7314150266920	1	409
FF1A40	7314150266951	1	404
FF1A4001	7314150286713	1	419
FF1A4002	7314150286560	1	419
FF1A4003	7314150286706	1	419
FF1A41	7314150266982	1	426
FF1A48	7314150271801	1	417
FF1A49	7314150271818	1	404
FF1A50	7314150271825	1	419
FF1A5001	7314150286430	1	404
FF1A5002	7314150286447	1	416
FF1A5003	7314150286690	1	409
FF1A5004	7314150286539	1	409
FF1A5005	7314150286546	1	409
FF1A5006	7314150286683	1	416
FF1A5007	7314150286553	1	426
FF1A5008	7314150286607	1	426
FF1A5009	7314150286669	1	426
FF1A5010	7314150286584	1	426
FF1A5011	7314150286614	1	427
FF1A5012	7314150286652	1	427
FF1A5013	7314150286577	1	410
FF1A5015	7314150307401	1	427
FF1A5017	7314150307425	1	427
FF1A5019	7314150309436	1	427
FF1A5021	7314150309467	1	427
FF1A5022	7314150309474	1	428
FF1A5023	7314150309498	1	428
FF1A5024	7314150309504	1	428
FF1A5027	7314150320684	1	416
FF1A5028	7314150320691	1	428
FF1A5029	7314150320707	1	428
FF1A5030	7314150320714	1	428
FF1A5031	7314150320721	1	429
FF1A5032	7314150320738	1	410
FF1A5036	7314150339037	1	429
FF1A5038	7314150339051	1	429



FF1A51



FF1A51	7314150271832	1	420
FF1A53	7314150271856	1	429
FF1A54	7314150288786	1	410
FF1A55	7314150299720	1	410
FF1A56	7314150299737	1	417
FF1A65	7314150313389	1	417
FF1A66	7314150313396	1	429
FF1A67	7314150313402	1	429
FF1A68	7314150313419	1	420
FF1A70	7314150320189	1	410
FF1A71	7314150320196	1	413
FF1A72	7314150320202	1	430
FF1A82	7314150334070	1	433
FF1ASET-AUTO	7314150437993	1	451
FF1ASET-AUTO-M1	7314150438259	1	449
FF1ASET-AUTO-M2	7314150438327	1	449
FF1ASET-AUTO-M3	7314150438334	1	449
FF1ASET-AUTO-M4	7314150438341	1	450
FF1ASET-AUTO-M5	7314150438358	1	450
FF1ASET-AUTO-M6	7314150438365	1	450
FF1ASET-AUTO1	7314150254453	1	450
FF1ASET-AUTO2	7314150254460	1	450
FF1ASET-AUTO3	7314150254477	1	451
FF1ASET-AUTO6	7314150319909	1	451
FF1ASET-BASIC	7314150437368	1	441
FF1ASET-LARGE	7314150437108	1	441
FF1ASET-MRO2	7314150336623	1	454
FF1ASET-MRO3	7314150336630	1	455
FF1ASET-MRO4	7314150336647	1	455
FF1ASET-MRO5	7314150336654	1	455
FF1ASET-XLARGE	7314150436965	1	440
FF1B01LM	7314150455416	1	441
FF1B02LM	7314150455447	1	441
FF1B03LM	7314150455454	1	442
FF1B04LM	7314150455478	1	442
FF1B05LM	7314150455515	1	442
FF1B06LM	7314150455522	1	442
FF1B07LM	7314150455614	1	442
FF1B08LM	7314150455645	1	443
FF1B09LM	7314150455669	1	443
FF1B10LM	7314150455706	1	443
FF1B11LM	7314150455713	1	443
FF1BSET-MONSTER	7314150436835	1	440
FF1E1001	7314150285839	1	384
FF1E1002	7314150285761	1	384
FF1E1003	7314150285853	1	384
FF1E1004	7314150285754	1	384
FF1E1005	7314150285785	1	385
FF1E1006	7314150285778	1	385
FF1E1007	7314150285792	1	385
FF1E1008	7314150285822	1	385
FF1E1009	7314150285808	1	385
FF1E1009EH	7314150352579	1	393
FF1E1010	7314150285815	1	385
FF1E1011	7314150285846	1	385
FF1E1012EH	7314150352562	1	393
FF1E1013EH	7314150352586	1	393
FF1E2001	7314150285945	1	386
FF1E2002	7314150285921	1	386
FF1E2003	7314150286072	1	386
FF1E2004	7314150285952	1	386
FF1E2005	7314150285976	1	386
FF1E2006	7314150285914	1	387
FF1E2007	7314150285907	1	387
FF1E2008	7314150285860	1	387
FF1E2009EH	7314150352593	1	393
FF1E2010EH	7314150352654	1	393
FF1E2011EH	7314150373802	1	395
FF1E2101	7314150285877	1	387
FF1E2102	7314150286058	1	387
FF1E2103	7314150286089	1	387
FF1E2104	7314150285990	1	388
FF1E2105	7314150286041	1	388
FF1E2106EH	7314150352623	1	393
FF1E2107EH	7314150352661	1	393
FF1E2201	7314150286010	1	388
FF1E2202	7314150285891	1	388
FF1E2203	7314150285884	1	388
FF1E2204	7314150285983	1	388
FF1E2205	7314150285938	1	389
FF1E2206	7314150286034	1	389
FF1E2207	7314150285969	1	389
FF1E2208	7314150286027	1	389
FF1E2209	7314150286096	1	389
FF1E2210	7314150286065	1	389
FF1E2211	7314150339006	1	390
FF1E2212	7314150339013	1	390
FF1E2213	7314150339020	1	390
FF1E2214EH	7314150352647	1	393
FF1E2215EH	7314150352678	1	394
FF1E2216EH	7314150373833	1	395
FF1E2501	7314150286003	1	390
FF1E2502	7314150338993	1	390
FF1E2503EH	7314150352685	1	394
FF1E2504EH	7314150374106	1	395
FF1E2505EH	7314150373826	1	395



FF1E3001	7314150286119	1	391
FF1E3002	7314150286102	1	391
FF1E3003	7314150286157	1	391
FF1E3004	7314150286133	1	391
FF1E3005	7314150286126	1	391
FF1E3006	7314150286140	1	391
FF1E3007	7314150286164	1	391
FF1E3008	7314150286171	1	391
FF1E3009EH	7314150352722	1	394
FF1E3010EH	7314150352739	1	394
FF1E3011EH	7314150352753	1	394
FF1E4001	7314150285747	1	392
FF1E4002	7314150285730	1	392
FF1E4003EH	7314150352692	1	394
FF1E4004EH	7314150352708	1	394
FF1E4005EH	7314150352807	1	394
FF1E5001	7314150285716	1	392
FF1E5002	7314150285709	1	392
FF1E5003	7314150285723	1	392
FF1E5004	7314150338931	1	392
FF1E5005	7314150338948	1	390
FF1E5006	7314150338955	1	390
FF1E5007	7314150338962	1	392
FF1E5008	7314150338979	1	392
FF1E5009	7314150338986	1	391
FF1E5010EH	7314150352746	1	394
FF1E5011EH	7314150352777	1	395
FF1E5013EH	7314150352821	1	395
FF1E5014EH	7314150373864	1	395
FF1E5015EH	7314150373871	1	395
FF1E5016EH	7314150373888	1	395
FF1F1001	7314150286270	1	396
FF1F1002	7314150286287	1	396
FF1F1003	7314150286294	1	396
FF1F1004	7314150286263	1	396
FF1F1005	7314150286300	1	396
FF1F1006	7314150286249	1	396
FF1F1007	7314150286256	1	396
FF1F1008	7314150339129	1	397
FF1F1009	7314150339136	1	397
FF1F2001	7314150286317	1	397
FF1F2002	7314150339143	1	397
FF1F2101	7314150286331	1	397
FF1F2102	7314150339105	1	397
FF1F2103	7314150339112	1	398
FF1F2201	7314150286324	1	398
FF1F2202	7314150339150	1	398
FF1F2203	7314150339167	1	398
FF1F3001	7314150286348	1	398
FF1F3002	7314150286379	1	398
FF1F3003	7314150286409	1	399
FF1F3004	7314150286386	1	399
FF1F3005	7314150286362	1	399
FF1F3006	7314150286355	1	399
FF1F3007	7314150286393	1	399
FF1F3008	7314150286423	1	399
FF1F3009	7314150286416	1	399
FF1F3010	7314150339082	1	400
FF1F3011	7314150339099	1	400
FF1F4001	7314150286195	1	400
FF1F4002	7314150286201	1	400
FF1F4003	7314150286225	1	400
FF1F4004	7314150286232	1	400
FF1F4005	7314150286218	1	400
FF1F5001	7314150286188	1	401
FF1F5002	7314150339174	1	401
FF1F5003	7314150339181	1	401
FF1F5004	7314150339198	1	398
FF1F5005	7314150339204	1	401
FF1F5006	7314150339211	1	401
FF1F5007	7314150339228	1	401
FF1F5008	7314150339235	1	401
FF1F5009	7314150339242	1	402
FF1F5010	7314150339259	1	402
FF1F5011	7314150339266	1	402
FF1F5012	7314150339273	1	402
FF1F5013	7314150339280	1	398
FF2A07	7314150228201	1	459
FF2A08	7314150228225	1	459
FF2A09	7314150228249	1	459
FF2A10	7314150228263	1	463
FF2B01	7314150233441	1	460
FF2B02	7314150233465	1	460
FF2B03	7314150233489	1	460
FF2B04	7314150233502	1	460
FF2B05	7314150233526	1	461
FF2B06	7314150233540	1	461
FF2B07	7314150229420	1	461
FF2B08	7314150229451	1	461
FF2B09	7314150229482	1	461
FF2B10	7314150229505	1	462
FF2B11	7314150229529	1	462
FF2B12	7314150229543	1	462
FF2B13	7314150229567	1	462
FF2B14	7314150229581	1	462
FF2B15	7314150229604	1	463



FF2B16	7314150229628	1	463
FF2C01	7314150327287	1	463
FF3A01	7314150228300	1	443
FF3A02	7314150228324	1	444
FF3A03	7314150228348	1	444
FF3A04	7314150228362	1	444
FF3A05	7314150228386	1	444
FF3A06	7314150228416	1	444
FF3A07	7314150228430	1	445
FF3A08	7314150228454	1	445
FF3A09	7314150228478	1	445
FF3A10	7314150228492	1	445
FF3A11	7314150228515	1	445
FF3A12	7314150228539	1	446
FF3A13	7314150228614	1	446
FF3A14	7314150228638	1	446
FF3A15	7314150228652	1	446
FF3A16	7314150228676	1	446
FF3A17	7314150228690	1	447
FFSS-1.5-900FG	7311518275884	4	614
FGS-1.0-600	7311518123796	4	614
FGS-1.25-700	7311518123802	4	614
FGS-1.25-700-WB	7314150398720	4	614
FGS-1.6-810	7311518123819	4	614
FGS-1.6-810-WB	7314150399086	4	614
FGS-1.8-810	7311518123826	4	614
FM10	7311518010881	5	31
FM12	7314150273249	5	31
FP-3M	7311518168612	1	641
FS-5	7311518266455	10	647
FS-7.5	7311518266479	10	647
FS-8	7311518266462	10	647
G0313M03	7311518036089	1	144
G0313M03X	7311518182069	1	144
G0613M03X	7311518196592	1	144
G0618M06	7311518036119	1	144
G0618M06X	7311518036133	1	144
G0820M06	7311518036164	1	144
G0820M06X	7311518036188	1	144
G1020I06	7314150501519	5	147
G1020M06	7311518036218	1	144
G1020M06X	7311518036232	1	144
G1020S06	7314150501540	5	146
G1225I06	7314150501571	5	147
G1225M06	7311518036317	1	144
G1225M06X	7311518036331	1	144
G1225M08	7311518036362	1	144
G1225M08X	7311518188009	1	144
G1225S06	7314150501601	5	146
G1625M06	7311518192648	1	144
G1625M06X	7311518187415	1	144
G1625M08	7311518036409	1	144
G1625M08X	7311518036423	1	144
GL008-10	7314150167050	5	499
GL008-8	7314150167043	5	499
GL010-10	7314150167098	5	499
GL010-8	7314150167081	5	499
GS-180-F	7311518275488	6	646
GS-76	7311518010782	8	646
H0613M03X	7311518196615	1	145
H1020I06	7314150501717	5	147
H1025M06	7311518182304	1	145
H1025M06X	7311518182311	1	145
H1232I06	7314150501748	5	147
H1232M06	7311518182076	1	145
H1232M06X	7311518181758	1	145
H1635M06	7311518192730	1	145
H1635M06X	7311518187422	1	145
H1635M08	7311518182083	1	145
H1635M08X	7311518182090	1	145
HFGPS-0.7-400FG	7311518275877	4	614
HGPS-0.6-360	7311518123680	10	614
HGPS-0.8-380	7311518123697	4	614
HGPS-0.8-380-WB	7314150398812	4	614
HGPS-1.0-400	7311518123703	4	614
HGPS-1.0-400-WB	7314150398713	4	614
HRFM10	7311518010898	5	31
HUS-0.6-380	7311518123659	4	614
HUS-0.8-500	7311518123666	4	614
HUS-1.0-650	7311518123673	4	614
IZO-D-135	7314151845827	1	107
IZO-D-200	7314151846831	1	107
IZO-D-30	7314151846824	1	107
IZO-D-340	7314151846848	1	107
IZO-DR-810	7314151846817	1	107
J0604M06	7311518036508	1	145
J1010M06	7311518172473	1	145
J1212M06	7311518036577	1	145
J1616M06	7311518187439	1	145
J1616M08	7311518036614	1	145
K-AP-1	7311518030117	10	646
K-GP-1	7311518030131	10	647
K0602M06	7311518036652	1	145
K1008M06	7311518036683	1	145
K1210M06	7311518036720	1	145
K1612M06	7311518193959	1	145



K1612M08	7311518036768	1	145
K172	7314150384396	1	173
K18NF-2	7314151347161	5	170
K18PH-2M5	73141503019646	5	170
K18PH-2M6	7314150274871	5	170
K19PZD-2M5	7314151693237	1	170
K19PZD-2NF	7314151586157	1	170
K20TORX-T25	7314151825799	10	170
K560F-1	7314151825492	5	173
K560F-2	7314151825324	5	174
K560F-3	7314151825331	5	174
K560F-4	7314151825348	5	178
K560F-5	7314151825355	5	178
K560F-6	7314151825362	5	181
K560F-7	7314151825379	5	183
K560F-8	7314151825508	5	183
K560F-9	7314151846688	5	185
K66100-1/4	7314150204540	1	172
K66100-1/4-1P	7314150260201	25	172
K66100-3/8	7314150204564	1	172
K66100-3/8-1P	7314150260249	25	172
K6625-1/4	7314150204496	1	172
K6625-1/4-1P	7314150260140	1	172
K6638-3/8	7314150204557	1	172
K6638-3/8-1P	7314150260164	25	172
K6650-1/2	7314150204519	1	172
K6650-1/2-1P	7314150260188	1	172
K6650-1/4	7314150204526	1	172
K6650-1/4-1P	7314150204533	1	172
K6650-3/8	7314150204502	1	172
K6650-3/8-1P	7314150260225	1	172
K6660-QR-1P	7314150204571	1	172
K6701M-10	7314151778149	1	172
K6701M-11	7314151778224	1	172
K6701M-12	7314151811891	1	172
K6701M-13	7314151778491	1	172
K6701M-14	7314151844172	1	172
K6701M-6	7314151813260	1	172
K6701M-7	7314151777920	1	172
K6701M-8	7314151778064	1	172
K6701M-9	7314151815110	1	172
K6750-1/4	7314150204663	1	170
K6750-10	7314150204700	1	170
K6750-13	7314150204823	1	170
K6750-3/8	7314150204656	1	170
K6750-6	7314150204670	1	170
K6750-7	7314150204687	1	170
K6750-8	7314150204694	1	170
K6964C	7314151215170	1	174
K7401M-10	7314151780128	1	173
K7401M-11	7314151780395	1	173
K7401M-12	7314151811907	1	173
K7401M-13	7314151780470	1	173
K7401M-14	7314151780555	1	173
K7401M-15	7314151812140	1	173
K7401M-16	7314151780630	1	173
K7401M-17	7314151780715	1	173
K7401M-18	7314151812157	1	173
K7401M-19	7314151812164	1	173
K7401M-20	7314151844271	1	173
K7401M-21	7314151845216	1	173
K7401M-22	7314151845223	1	173
K7401M-24	7314151844295	1	173
K7401M-7	7314151812126	1	173
K7401M-8	7314151780043	1	173
K7401M-9	7314151812133	1	173
K7401M10	7314150389919	1	174
K7401TORX-E-S7	7314150343324	1	175
K7401TORX-E10	7314151844448	1	174
K7401TORX-E12	7314151844455	1	174
K7401TORX-E14	7314151844462	1	174
K7401TORX-E5	7314151844400	1	174
K7401TORX-E6	7314151844417	1	174
K7401TORX-E7	7314151844424	1	174
K7401TORX-E8	7314151844431	1	174
K7401Z-1/2	7314150384402	1	173
K7401Z-11/16	7314150384419	1	173
K7401Z-13/16	7314150384426	1	173
K7401Z-3/4	7314150384433	1	173
K7401Z-3/8	7314150384440	1	173
K7401Z-5/8	7314150384457	1	173
K7401Z-7/16	7314150384464	1	173
K7401Z-7/8	7314150384471	1	173
K7401Z-9/16	7314150384488	1	173
K7406M-10	7314151844479	1	173
K7406M-13	7314151844486	1	173
K7406M-17	7314151844493	1	173
K7760C-1	7314151222369	1	174
K7760C-2	7314151222376	1	174
K7764D	7314151222475	1	177
K7767S	7314151222512	1	174
K7800M-10	7314150326297	1	175
K7800M-11	7314150326303	1	175
K7800M-12	7314150326310	1	175
K7800M-13	7314150326327	1	175
K7800M-14	7314150326334	1	175



K7800M-15



K7800M-15	7314150326341	1	175
K7800M-16	7314150326358	1	175
K7800M-17	7314150326365	1	175
K7800M-18	7314150326372	1	175
K7800M-19	7314150326389	1	175
K7800M-21	7314150326396	1	175
K7800M-22	7314150326402	1	175
K7800M-24	7314150326419	1	175
K7800M/13	7314150437221	1	178
K7801M-10	7314151778576	1	175
K7801M-11	7314151778651	1	175
K7801M-12	7314151815790	1	175
K7801M-13	7314151778736	1	175
K7801M-14	7314151778811	1	175
K7801M-15	7314151815806	1	175
K7801M-16	7314151779030	1	175
K7801M-17	7314151779115	1	175
K7801M-18	7314151779382	1	175
K7801M-19	7314151779467	1	175
K7801M-20	7314151844509	1	175
K7801M-21	7314151779542	1	175
K7801M-22	7314151779627	1	175
K7801M-23	7314151844516	1	175
K7801M-24	7314151779894	1	175
K7801M-25	7314151844523	1	175
K7801M-26	7314151844530	1	175
K7801M-27	7314151779979	1	175
K7801M-28	7314150430154	1	175
K7801M-29	7314150430161	1	175
K7801M-30	7314151811914	1	175
K7801M-32	7314151825157	15	175
K7801M-34	7314151844547	1	175
K7801M-36	7314151844554	1	175
K7801M-8	7314151845230	1	175
K7801M-9	7314151845247	1	175
K7801TORX-E10	7314151811587	1	177
K7801TORX-E12	7314151811594	1	177
K7801TORX-E14	7314151811600	1	177
K7801TORX-E16	7314151811617	1	177
K7801TORX-E18	7314151811624	1	177
K7801TORX-E20	7314151811631	1	177
K7801TORX-E24	7314151811648	1	177
K7801VM-17	7314151781521	1	176
K7801VM-19	7314151781798	1	176
K7801VM-22	7314151781873	1	176
K7801VM-24	7314151781958	1	176
K7801VM/S4	7314151799090	1	178
K7801Z-1	7314151844639	1	176
K7801Z-1.1/16	7314151844646	1	176
K7801Z-1.1/2	7314150137701	5	176
K7801Z-1.1/4	7314151844660	1	176
K7801Z-1.1/8	7314151844653	1	176
K7801Z-1.3/8	7314150137688	5	176
K7801Z-1.5/16	7314150137671	5	176
K7801Z-1.7/16	7314150137695	5	176
K7801Z-1/2	7314151822620	1	176
K7801Z-11/16	7314151844592	1	176
K7801Z-13/16	7314151844608	1	176
K7801Z-15/16	7314151844622	1	176
K7801Z-3/4	7314151822668	1	176
K7801Z-3/8	7314151822606	1	176
K7801Z-5/8	7314151844585	1	176
K7801Z-7/16	7314151844561	1	176
K7801Z-7/8	7314151844615	1	176
K7801Z-9/16	7314151822637	1	176
K7801Z/10	7314150165018	1	178
K7806M-10	7314151844677	1	175
K7806M-11	7314151844684	1	175
K7806M-12	7314151844691	1	175
K7806M-13	7314151805944	1	175
K7806M-14	7314151844707	1	175
K7806M-15	7314150330683	1	175
K7806M-16	7314151844714	1	175
K7806M-17	7314151805951	1	175
K7806M-18	7314151844721	1	175
K7806M-19	7314151805968	1	175
K7806M-21	7314151823597	1	175
K7806M-22	7314151805975	1	175
K7806M-23	7314151844738	1	175
K7806M-24	7314151805982	1	175
K7806M-27	7314151805999	1	175
K7806M-30	7314151844578	1	175
K7806M-32	7314150220304	1	175
K7806M-36	7314150220311	1	175
K7806M/S4	7314151813222	1	178
K7806Z-1	7314150137817	5	176
K7806Z-1.1/16	7314150137824	5	176
K7806Z-1.1/2	7314150137886	5	176
K7806Z-1.1/4	7314150137848	5	176
K7806Z-1.1/8	7314150137831	5	176
K7806Z-1.3/8	7314150137862	5	176
K7806Z-1.5/16	7314150137855	5	176
K7806Z-1.7/16	7314150137879	5	176
K7806Z-1/2	7314150137749	10	176
K7806Z-11/16	7314150137770	5	176
K7806Z-13/16	7314150137794	5	176



K7806Z-15/16	7314150137718	5	176
K7806Z-3/4	7314150137787	5	176
K7806Z-3/8	7314150137725	10	176
K7806Z-5/8	7314150137763	5	176
K7806Z-7/16	7314150137732	5	176
K7806Z-7/8	7314150137800	5	176
K7806Z-9/16	7314150137756	10	176
K7806Z/10	7314150165025	1	178
K8160D-1	7314151237400	1	177
K8160D-2	7314151237417	1	177
K8160D-3	7314151237424	1	177
K8164C	7314151237523	1	174
K8164F	7314151237554	1	180
K8167S	7314151237592	1	177
K8901M-17	7314151803155	1	179
K8901M-18	7314151844189	1	179
K8901M-19	7314151803162	1	179
K8901M-21	7314151803179	1	179
K8901M-22	7314151803186	1	179
K8901M-23	7314151803193	1	179
K8901M-24	7314151803209	1	179
K8901M-27	7314151803216	1	179
K8901M-28	7314151803223	1	179
K8901M-29	7314151803230	1	179
K8901M-30	7314151803247	1	179
K8901M-32	7314151803254	1	179
K8901M-33	7314151803261	1	179
K8901M-34	7314151803278	1	179
K8901M-36	7314151803285	1	179
K8901M-38	7314151803292	1	179
K8901M-41	7314151803308	1	179
K8901M-46	7314151803315	1	179
K8901M-50	7314151846398	1	179
K8901M-55	7314151846404	1	179
K8901M-60	7314151846411	1	179
K8901M/8	7314150165032	1	177
K8901Z-1	7314151844752	1	180
K8901Z-1.1/16	7314151844769	1	180
K8901Z-1.1/2	7314151844820	1	180
K8901Z-1.1/4	7314151844783	1	180
K8901Z-1.1/8	7314151844776	1	180
K8901Z-1.11/16	7314150130269	1	180
K8901Z-1.13/16	7314150130276	1	180
K8901Z-1.15/16	7314150130290	1	180
K8901Z-1.3/16	7314150130245	1	180
K8901Z-1.3/4	7314151844844	1	180
K8901Z-1.3/8	7314151844806	1	180
K8901Z-1.5/16	7314151844790	1	180
K8901Z-1.5/8	7314151844837	1	180
K8901Z-1.7/16	7314151844813	1	180
K8901Z-1.7/8	7314150130283	1	180
K8901Z-1.9/16	7314150130252	1	180
K8901Z-11/16	7314150130238	1	180
K8901Z-13/16	7314151844226	1	180
K8901Z-15/16	7314151844745	1	180
K8901Z-2	7314150130306	1	180
K8901Z-2.1/16	7314150130313	1	180
K8901Z-2.1/4	7314150130344	1	180
K8901Z-2.3/16	7314150130337	1	180
K8901Z-2.3/8	7314150130351	1	180
K8901Z-3/4	7314151844202	1	180
K8901Z-7/8	7314151844301	1	180
K8901Z/8	7314150436514	1	181
K8901Z/8	7314150165049	1	181
K8906M-17	7314151803056	1	179
K8906M-19	7314151803063	1	179
K8906M-21	7314151844851	1	179
K8906M-22	7314151803070	1	179
K8906M-24	7314151803087	1	179
K8906M-27	7314151803094	1	179
K8906M-30	7314151803117	1	179
K8906M-32	7314151803124	1	179
K8906M-33	7314151844868	1	179
K8906M-34	7314151844875	1	179
K8906M-36	7314151803148	1	179
K8906M-41	7314151845254	1	179
K8906M-46	7314150220601	1	179
K8906M/8	7314150165056	1	181
K8906Z-1	7314150130436	1	180
K8906Z-1.1/16	7314150130443	1	180
K8906Z-1.1/2	7314150130511	1	180
K8906Z-1.1/4	7314150130474	1	180
K8906Z-1.1/8	7314150130450	1	180
K8906Z-1.3/4	7314150130559	1	180
K8906Z-1.3/8	7314150130498	1	180
K8906Z-1.5/16	7314150130481	1	180
K8906Z-1.5/8	7314150130535	1	180
K8906Z-1.7/16	7314150130504	1	180
K8906Z-13/16	7314150130405	1	180
K8906Z-15/16	7314150130429	1	180
K8906Z-2	7314150130580	1	180
K8906Z-3/4	7314150130399	1	180
K8906Z-7/8	7314150130412	1	180
K8906Z/8	7314150165063	1	181
K8909H-5	7314151619343	1	181
K8909ML-12	7314151232863	1	183



K8909ML-14	7314151232870	1	183
K8909ML-17	7314151232887	1	183
K8960F-2	7314151268138	1	181
K8960F-3	7314151268145	1	181
K8960F-4	7314150220625	1	181
K8964D	7314151268237	1	177
K8964G	7314151268268	1	182
K8967S	7314151268329	1	180
K9501M-22	7314151844882	1	182
K9501M-24	7314151802677	1	182
K9501M-27	7314151802684	1	182
K9501M-30	7314151802714	1	182
K9501M-32	7314151802721	1	182
K9501M-33	7314151802738	1	182
K9501M-34	7314151802745	1	182
K9501M-36	7314151802752	1	182
K9501M-38	7314151802769	1	182
K9501M-41	7314151802776	1	182
K9501M-42	7314151802783	1	182
K9501M-46	7314151802790	1	182
K9501M-50	7314151802806	1	182
K9501M-55	7314151802813	1	182
K9501M-60	7314151802820	1	182
K9501M-65	7314151802837	1	182
K9501M-70	7314151802844	1	182
K9501M-75	7314151802851	1	182
K9501M-80	7314151802868	1	182
K9501M-85	7314150352197	1	182
K9501Z-1	7314151844912	1	182
K9501Z-1.1/16	7314150130634	1	182
K9501Z-1.1/2	7314151844943	1	182
K9501Z-1.1/4	7314151844929	1	182
K9501Z-1.1/8	7314150130641	1	182
K9501Z-1.11/16	7314150130696	1	182
K9501Z-1.13/16	7314151844967	1	182
K9501Z-1.15/16	7314150130719	1	182
K9501Z-1.3/16	7314150130658	1	182
K9501Z-1.3/4	7314150130702	1	182
K9501Z-1.3/8	7314150130672	1	182
K9501Z-1.5/16	7314150130665	1	182
K9501Z-1.5/8	7314151844950	1	182
K9501Z-1.7/16	7314151844936	1	182
K9501Z-1.7/8	7314151844974	1	182
K9501Z-1.9/16	7314150130689	1	182
K9501Z-2	7314150130726	1	182
K9501Z-2.1/4	7314150130764	1	182
K9501Z-2.1/8	7314150130740	1	182
K9501Z-2.3/16	7314150130757	1	182
K9501Z-2.3/4	7314150130832	1	182
K9501Z-2.5/16	7314150130771	1	182
K9501Z-2.9/16	7314150130801	1	182
K9506M-22	7314151844998	1	182
K9506M-24	7314151802530	1	182
K9506M-27	7314151802547	1	182
K9506M-30	7314151802554	1	182
K9506M-32	7314151802561	1	182
K9506M-33	7314151802578	1	182
K9506M-34	7314151845018	1	182
K9506M-36	7314151802585	1	182
K9506M-38	7314151802592	1	182
K9506M-41	7314151802608	1	182
K9506M-46	7314151802615	1	182
K9506M-50	7314151802622	1	182
K9506M-55	7314151802639	1	182
K9506M-60	7314151802646	1	182
K9506Z-1	7314150131686	1	182
K9506Z-1.1/16	7314150131693	1	182
K9506Z-1.1/2	7314150131761	1	182
K9506Z-1.1/4	7314150131723	1	182
K9506Z-1.13/16	7314150131808	1	182
K9506Z-1.3/16	7314150131716	1	182
K9506Z-1.5/8	7314150131785	1	182
K9506Z-1.7/16	7314150131754	1	182
K9506Z-1.7/8	7314150131815	1	182
K9509H5	7314151619428	1	182
K9509ML-19	7314151618964	1	183
K9509ML-22	7314151619183	1	183
K9509ML-24	7314151619268	1	183
K9560G-0	7314150240012	1	183
K9560G-1	7314151285944	1	183
K9560G-2	7314151285951	1	183
K9560G-3	7314151285968	1	183
K9560G-4	7314150133970	1	183
K9560G-5	7314150133987	1	183
K9564F	7314151286026	1	180
K9567S	7314151286095	1	183
K9598H	7314150133956	1	184
K9801M-100	7314151845162	1	183
K9801M-105	7314151845179	1	183
K9801M-110	7314151845186	1	183
K9801M-115	7314151845193	1	183
K9801M-120	7314151845209	1	183
K9801M-125	7314150167159	1	183
K9801M-130	7314150167166	1	183
K9801M-135	7314150167173	1	183
K9801M-140	7314150167180	1	183



K9801M-145	7314150167197	1	183
K9801M-150	7314150167203	1	183
K9801M-155	7314150167210	1	183
K9801M-46	7314151845056	1	183
K9801M-50	7314151845063	1	183
K9801M-55	7314151845070	1	183
K9801M-60	7314151845087	1	183
K9801M-65	7314151845094	1	183
K9801M-70	7314151845100	1	183
K9801M-75	7314151845117	1	183
K9801M-80	7314151845124	1	183
K9801M-85	7314151845131	1	183
K9801M-90	7314151845148	1	183
K9801M-95	7314151845155	1	183
K9801Z-1.1/2	7314150131976	1	184
K9801Z-1.11/16	7314150132003	1	184
K9801Z-1.13/16	7314150132027	1	184
K9801Z-1.15/16	7314150132041	1	184
K9801Z-1.3/4	7314150132010	1	184
K9801Z-1.3/8	7314150131952	1	184
K9801Z-1.5/8	7314150131990	1	184
K9801Z-1.7/16	7314150131969	1	184
K9801Z-1.7/8	7314150132034	1	184
K9801Z-1.9/16	7314150131983	1	184
K9801Z-2	7314150132058	1	184
K9801Z-2.1/16	7314150132065	1	184
K9801Z-2.1/2	7314150132133	1	184
K9801Z-2.1/4	7314150132096	1	184
K9801Z-2.1/8	7314150132072	1	184
K9801Z-2.11/16	7314150132164	1	184
K9801Z-2.13/16	7314150132188	1	184
K9801Z-2.15/16	7314150132201	1	184
K9801Z-2.3/16	7314150132089	1	184
K9801Z-2.3/4	7314150132171	1	184
K9801Z-2.3/8	7314150132119	1	184
K9801Z-2.5/16	7314150132102	1	184
K9801Z-2.5/8	7314150132157	1	184
K9801Z-2.7/16	7314150132126	1	184
K9801Z-2.7/8	7314150132195	1	184
K9801Z-2.9/16	7314150132140	1	184
K9801Z-3	7314150132218	1	184
K9801Z-3.1/16	7314150132225	1	184
K9801Z-3.1/2	7314150132287	1	184
K9801Z-3.1/4	7314150132249	1	184
K9801Z-3.1/8	7314150132232	1	184
K9801Z-3.11/16	7314150132317	1	184
K9801Z-3.13/16	7314150132331	1	184
K9801Z-3.15/16	7314150132355	1	184
K9801Z-3.3/4	7314150132324	1	184
K9801Z-3.3/8	7314150132263	1	184
K9801Z-3.5/16	7314150132256	1	184
K9801Z-3.5/8	7314150132300	1	184
K9801Z-3.7/16	7314150132270	1	184
K9801Z-3.7/8	7314150132348	1	184
K9801Z-3.9/16	7314150132294	1	184
K9801Z-4	7314150132362	1	184
K9801Z-4.1/16	7314150132379	1	184
K9801Z-4.1/2	7314150132430	1	184
K9801Z-4.1/4	7314150132393	1	184
K9801Z-4.1/8	7314150132386	1	184
K9801Z-4.3/4	7314150132454	1	184
K9801Z-4.3/8	7314150132416	1	184
K9801Z-4.5/16	7314150132409	1	184
K9801Z-4.5/8	7314150132447	1	184
K9801Z-4.7/16	7314150132423	1	184
K9806M-100	7314150131105	1	183
K9806M-105	7314150131112	1	183
K9806M-110	7314150131129	1	183
K9806M-115	7314150131136	1	183
K9806M-120	7314150131143	1	183
K9806M-41	7314150130986	1	183
K9806M-46	7314150130993	1	183
K9806M-50	7314150131006	1	183
K9806M-55	7314150131013	1	183
K9806M-60	7314150131020	1	183
K9806M-65	7314150131037	1	183
K9806M-70	7314150131044	1	183
K9806M-75	7314150131051	1	183
K9806M-80	7314150131068	1	183
K9806M-85	7314150131075	1	183
K9806M-90	7314150131082	1	183
K9806M-95	7314150131099	1	183
K9806Z-1.1/2	7314150131174	1	184
K9806Z-1.11/16	7314150131198	1	184
K9806Z-1.3/8	7314150131150	1	184
K9806Z-1.5/8	7314150131181	1	184
K9806Z-1.7/16	7314150131167	1	184
K9806Z-2	7314150131204	1	184
K9806Z-2.1/16	7314150131211	1	184
K9806Z-2.1/2	7314150131273	1	184
K9806Z-2.1/4	7314150131235	1	184
K9806Z-2.11/16	7314150131303	1	184
K9806Z-2.13/16	7314150131327	1	184
K9806Z-2.15/16	7314150131341	1	184
K9806Z-2.3/16	7314150131228	1	184
K9806Z-2.3/4	7314150131310	1	184



K9806Z-2.3/8



K9806Z-2.3/8	7314150131259	1	184
K9806Z-2.5/16	7314150131242	1	184
K9806Z-2.5/8	7314150131297	1	184
K9806Z-2.7/16	7314150131266	1	184
K9806Z-2.7/8	7314150131334	1	184
K9806Z-2.9/16	7314150131280	1	184
K9806Z-3	7314150131358	1	184
K9806Z-3.1/16	7314150131365	1	184
K9806Z-3.1/2	7314150131433	1	184
K9806Z-3.1/4	7314150131396	1	184
K9806Z-3.1/8	7314150131372	1	184
K9806Z-3.11/16	7314150131464	1	184
K9806Z-3.13/16	7314150131488	1	184
K9806Z-3.15/16	7314150131501	1	184
K9806Z-3.3/16	7314150131389	1	184
K9806Z-3.3/4	7314150131471	1	184
K9806Z-3.3/8	7314150131419	1	184
K9806Z-3.5/16	7314150131402	1	184
K9806Z-3.5/8	7314150131457	1	184
K9806Z-3.7/16	7314150131426	1	184
K9806Z-3.7/8	7314150131495	1	184
K9806Z-3.9/16	7314150131440	1	184
K9806Z-4	7314150131518	1	184
K9806Z-4.1/16	7314150131525	1	184
K9806Z-4.1/2	7314150131570	1	184
K9806Z-4.1/4	7314150131549	1	184
K9806Z-4.1/8	7314150131532	1	184
K9806Z-4.3/4	7314150131594	1	184
K9806Z-4.3/8	7314150131563	1	184
K9806Z-4.5/16	7314150131556	1	184
K9806Z-4.5/8	7314150131587	1	184
K9860H-1	7314150133994	1	184
K9860H-2	7314150134007	1	184
K9860H-3	7314150134014	1	184
K9867S	7314150133932	1	184
K9895G	7314150133949	1	183
K9899H	7314150166763	1	185
K9998H	7314150133963	1	185
KB09-01	7314150196968	5	595
KB18-01	7314150196944	5	595
KBFU-01	7314150196913	5	594
KBGH-5P-DISPEN	7314150296729	20	595
KBGR-5P-DISPEN	7314150296774	20	595
KBGU-100P	7314150213405	1	595
KBGU-10P-DISPEN	7314150262984	20	595
KBGU-5P-DISPEN	7314150296705	20	595
KBRU-01	7314150196876	5	594
KBSK-01	7314150196999	5	597
KBSU-01	7314150197002	5	597
KBTU-01	7314150196982	5	597
KBWS-01	7314150225972	10	600
KCB753	7314150204915	1	171
KE18-01	7314150196937	5	594
KEFU-01	7314150196906	5	594
KERU-01	7314150196869	5	594
KEYRING	7314150500864	50	380
KG09-01	7314150196975	5	596
KG09-01-3P	7314150213962	10	596
KG18-01	7314150196951	5	596
KGAU-01	7314150223893	5	596
KGFU-01	7314150196920	5	594
KGRU-01	7314150196883	5	594
KGRU-02	7314150196890	5	594
KGSU-01	7314150197019	5	597
KHU-01	7314150268955	4	596
KM11/4-5/16-1P	7314150275953	50	172
KM100-SH	7314150215690	1	171
KM653	7314151786915	1	171
KM653-1P	7314151840709	25	171
KM653-QR	7314150115983	1	170
KM653-QR-1P	7314151848507	50	170
KM653-SF	7314150204984	1	171
KM6701M-10	7314151844264	1	173
KM6701M-7	7314151844240	1	173
KM6701M-8	7314151844257	1	173
KM6750-1/4	7314150204595	1	170
KM6750-10	7314150204649	20	170
KM6750-11	7314150302628	1	170
KM6750-13	7314150204632	1	170
KM6750-3/8	7314150204588	1	170
KM6750-6	7314150204601	1	170
KM6750-7	7314150204618	1	170
KM6750-8	7314150204625	1	170
KM753-QR-1P	7314150204830	1	171
KMR150	7314150204960	1	172
KMR150-1P	7314150204977	1	172
KMR653	7314150204922	1	171
KMR653-1P	7314150204939	1	171
KMR753	7314150204946	1	171
KMR753-1P	7314150204953	1	171
KMT753-QR-1P	7314150391523	50	171
KMU-01	7314150197026	5	594
KR653	7314150204885	1	171
KR653-1P	7314150206263	25	171
KRSS-01	7314150214938	10	600
KS7401M-10	7314150384495	1	174



KS7401M-11	7314150384501	1	174
KS7401M-12	7314150384518	1	174
KS7401M-13	7314150384525	1	174
KS7401M-14	7314150384532	1	174
KS7401M-15	7314150384549	1	174
KS7401M-16	7314150384556	1	174
KS7401M-17	7314150384563	1	174
KS7401M-18	7314150384570	1	174
KS7401M-19	7314150384587	1	174
KS7401M-22	7314150384594	1	174
KS7401M-9	7314150384600	1	174
KSBG09-10DISPEN	7314150262991	20	596
KSBG18-10DISPEN	7314150263004	20	596
KSR753	7314150204892	1	541
KSR753-1P	7314150204908	1	541
KUBG09-5P	7314150213450	20	596
KUBG18-5DISPEN	7314150296835	20	596
KUBG18-5P	7314150213443	20	596
L1020I06	7314150501649	5	147
L1020M06	7311518133665	1	145
L1020M06X	7311518136369	1	145
L1020S06	7314150501670	5	147
L1225M06	7311518132774	1	145
L1225M06X	7311518136857	1	145
L1228I06	7314150501700	5	147
L1228S06	7314150501731	5	147
L1230AL06	7311518187668	1	146
L1230AL08	7311518181871	1	146
L1230M06	7311518182168	1	145
L1230M06X	7311518182175	1	145
L1630M06	7311518192914	1	145
L1630M06X	7311518187446	1	145
L1630M08	7311518182205	1	145
L1630M08X	7311518136833	1	145
LAP-KNIFE	7311518216443	10	649
LARGE	7314150437429	1	435
LS-6160-23	7311518041304	1	651
LS-COIN 19 CM	7311518031077	1	616
LS-COIN 26 CM	7311518333041	2	616
LS-COMBINESS	7311518041366	1	651
LS-MASSE-4	7311518012014	2	615
LS-MASSE-4FG	7311518275891	2	615
LS-MASSE-TR-4FG	7311518281106	2	615
LS-MERLIN-2.5	7311518012069	2	615
LS-MERLIN-2.5FG	7311518281113	2	615
LS-PIERRE CORINDON	7311518009977	1	651
LS-PIERRE-FAUX	7311518009038	1	651
LST-30111	7314150337262	5	630
LST-51121	7314150337231	5	630
LST-52121	7314150337224	5	630
LST-63102	7314150337330	5	630
LST-70120	7314150337255	5	630
LST-72324	7314150337163	5	630
LST-99102	7314150337354	4	630
LT-STEEL-30	7314150138012	5	553
LT-STEEL-50	7314150138029	5	553
LTB-10	7314150120048	6	553
LTB-20	7314150120062	6	553
LTB-30	7314150120086	6	553
LTG-10	7314150119981	6	553
LTG-20	7314150120000	6	553
LTG-30	7314150120024	6	553
LTS-100	7314150120147	5	553
LTS-100-E	7314150120154	5	553
LTS-30	7314150120109	5	553
LTS-30-E	7314150120116	5	553
LTS-50	7314150120123	5	553
LTS-50-E	7314150120130	5	553
LUB-2015	7311518335427	6	651
M0310M03	7311518036805	1	145
M0310M03X	7311518197063	1	145
M0613M03X	7311518196622	1	145
M0618M06	7311518036836	1	145
M0618M06X	7311518036850	1	145
M1022M06	7311518036881	1	145
M1022M06X	7311518036904	1	145
M1227M06	7311518036928	1	145
M1227M06X	7311518036959	1	145
M1227M08	7311518036980	1	145
M1630M06	7311518193010	1	145
M1630M06X	7311518187453	1	145
M1630M08	7311518037062	1	145
M1630M08X	7311518037086	1	145
M227L	7311518160883	4	591
M227R	7311518160869	4	592
M330	7311518160906	4	592
M526	7311518160982	4	592
M6376	7311518196486	1	592
M6376-SH	7311518199296	1	592
M676	7311518161088	1	592
M676-SH	7311518211875	1	592
M780	7314151826215	1	219
M781	7314153016218	5	219
M926	7311518161071	1	593
M926-SH	7314150107537	1	593
MA225	7311518161057	4	590



MA225L	7311518161033	4	590
MA225R	7311518161040	4	590
MA311	7314150181568	1	590
MA321	7314150181551	10	590
MA325	7311518161064	4	591
MA351	7314150181582	10	591
MA361	7314150181575	10	591
MA401	7314150167593	10	590
MA411	7314150167609	10	590
MA421	7314150167616	10	590
MA431	7314150181544	1	590
MAM50M	7314150215300	1	117
MCP-2.5-810	7311518124052	2	615
MES-3.0-900	7311518123864	2	615
MES-3.5-900	7311518123871	2	615
MES-3.5-900FG	7311518281120	2	615
MK5	7314150224333	1	59
MK9	7314150224326	1	59
MONSTER	7314150437405	1	435
MR227L	7311518161002	4	592
MR227R	7311518160999	4	592
MR340	7311518197537	2	591
MT-TS-3	7314150194995	12	552
MTB-3-16	7314150119066	6	552
MTB-3-16-M	7314150119073	6	552
MTB-3-16-M-E	7314150119141	6	552
MTB-5-25	7314150119080	6	552
MTB-5-25-C1	7314150119127	6	552
MTB-5-25-M	7314150119097	6	552
MTB-5-25-M-E	7314150119158	6	552
MTB-8-25	7314150125418	6	552
MTB-8-25-M	7314150127078	6	552
MTB-8-25-M-E	7314150127085	6	552
MTC-3-13	7314150321322	6	552
MTC-3-13-C1	7314150330843	6	552
MTC-5-16	7314150321339	6	552
MTC-5-16-C1	7314150330850	6	552
MTG-3-16	7314150118984	12	552
MTG-3-16-E	7314150119028	12	552
MTG-5-19	7314150118991	12	552
MTG-5-19-E	7314150119035	12	552
MTG-8-25	7314150330348	4	552
MTG-8-25-E	7314150390809	4	552
MTS-5-25	7314150119233	6	552
MTS-5-25-E	7314150119271	6	552
MTS-8-25	7314150119257	6	552
MTS-8-25-E	7314150119295	6	552
MTT051	7314150270521	6	600
MTT121	7314150213290	8	600
MTT151	7314150120703	6	600
MW-150	7314150125685	2	553
MW-250	7314150125678	2	553
N0306M03	7311518182212	1	145
N0306M03E	7311518182229	1	145
N0607M06	7311518182236	1	145
N1213M06	7311518134570	1	145
N1213M06X	7311518237172	1	145
N1613M06	7311518136000	1	145
N1613M06X	7311518204525	1	145
N1613M08	7311518182267	1	145
NP-12-COM	7311518264277	4	574
NP-12-TEN	7311518263959	10	578
NP-12-VEN	7311518264260	10	578
NP-16-U7/8-HP	7311518241773	4	575
NP-19-U7/8-HP	7311518241452	10	575
NP-22-F7/8-HP	7311518035204	10	576
NP-22-U7/8-HP	7311518034399	10	575
NS001-150	7314150316069	5	518
NS001-200	7314150316076	5	518
NS001-250	7314150316083	5	518
NS001-300	7314150316090	5	518
NS001-375	7314150325108	5	518
NS001-450	7314150325115	3	518
NS001-600	7314150325122	1	518
NS001-900	7314150325139	1	518
NS002-10	7314150284719	10	518
NS002-11	7314150292592	5	518
NS002-12	7314150292608	5	518
NS002-13	7314150284726	10	518
NS002-14	7314150284733	5	518
NS002-15	7314150292615	5	518
NS002-16	7314150292622	5	518
NS002-17	7314150284740	10	518
NS002-18	7314150292639	5	518
NS002-19	7314150284757	10	518
NS002-20	7314150292646	5	518
NS002-21	7314150292653	5	518
NS002-22	7314150292660	10	518
NS002-23	7314150292677	5	518
NS002-24	7314150292684	10	518
NS002-25	7314150292691	5	518
NS002-26	7314150292707	5	518
NS002-27	7314150284764	5	518
NS002-28	7314150292714	5	518
NS002-29	7314150292721	10	518
NS002-30	7314150292738	10	518



NS002-31	7314150292745	5	518
NS002-32	7314150284771	5	518
NS002-33	7314150292752	5	518
NS002-34	7314150292769	5	518
NS002-35	7314150292776	5	518
NS002-36	7314150284788	5	518
NS002-38	7314150292783	5	518
NS002-40	7314150292790	5	518
NS002-41	7314150292806	5	518
NS002-42	7314150292813	5	518
NS002-46	7314150292820	5	518
NS002-50	7314150292837	5	518
NS002-52	7314150292844	5	518
NS002-55	7314150292851	5	518
NS002-6	7314150292554	5	518
NS002-60	7314150292868	1	518
NS002-65	7314150292875	1	518
NS002-7	7314150292561	5	518
NS002-70	7314150292882	1	518
NS002-75	7314150292899	1	518
NS002-8	7314150292578	5	518
NS002-80	7314150292905	1	518
NS002-9	7314150292585	5	518
NS003-11	7314150306602	1	518
NS003-12	7314150306619	1	518
NS003-14	7314150306626	1	518
NS003-16	7314150306633	1	518
NS003-18	7314150320356	1	518
NS003-20	7314150320363	1	518
NS003-24	7314150320370	1	518
NS003-28	7314150320387	1	518
NS003-30	7314150320394	1	518
NS003-8	7314150320349	1	518
NS006-0607	7314150292912	1	519
NS006-0608	7314150292929	1	519
NS006-0708	7314150292936	1	519
NS006-0709	7314150292943	1	519
NS006-0809	7314150292967	1	519
NS006-0810	7314150292950	1	519
NS006-0910	7314150292974	1	519
NS006-0911	7314150292981	1	519
NS006-1011	7314150292998	1	519
NS006-1012	7314150293001	1	519
NS006-1013	7314150293018	1	519
NS006-1014	7314150293025	1	519
NS006-1113	7314150293032	1	519
NS006-1114	7314150293049	1	519
NS006-1213	7314150293056	1	519
NS006-1214	7314150293063	1	519
NS006-1315	7314150293070	1	519
NS006-1415	7314150293087	1	519
NS006-1416	7314150293094	1	519
NS006-1417	7314150293100	1	519
NS006-1617	7314150293117	1	519
NS006-1618	7314150293124	1	519
NS006-1719	7314150293131	1	519
NS006-1722	7314150293148	1	519
NS006-1819	7314150293155	1	519
NS006-1820	7314150293162	1	519
NS006-1920	7314150293179	1	519
NS006-1922	7314150293186	1	519
NS006-1924	7314150293193	1	519
NS006-2022	7314150293209	1	519
NS006-2122	7314150293216	1	519
NS006-2123	7314150293223	1	519
NS006-2223	7314150293230	1	519
NS006-2224	7314150293247	1	519
NS006-2227	7314150293254	1	519
NS006-2326	7314150293261	1	519
NS006-2425	7314150293278	1	519
NS006-2426	7314150293285	1	519
NS006-2427	7314150293292	1	519
NS006-2430	7314150293308	1	519
NS006-2528	7314150293315	1	519
NS006-2629	7314150293322	1	519
NS006-2729	7314150293339	1	519
NS006-2730	7314150293346	1	519
NS006-2732	7314150293353	1	519
NS006-2830	7314150293360	1	519
NS006-3031	7314150293377	1	519
NS006-3032	7314150293384	1	519
NS006-3034	7314150293391	1	519
NS006-3036	7314150293407	1	519
NS006-3234	7314150293414	1	519
NS006-3235	7314150293421	1	519
NS006-3236	7314150293438	1	519
NS006-3335	7314150293445	1	519
NS006-3436	7314150293452	1	519
NS006-3536	7314150293469	1	519
NS006-3638	7314150293476	1	519
NS006-3641	7314150293483	1	519
NS006-3642	7314150293490	1	519
NS006-4146	7314150293506	1	519
NS006-4650	7314150293513	1	519
NS006-5052	7314150293520	1	519
NS006-5055	7314150293537	1	519





NS006-5060	7314150293544	1	519
NS006-5062	7314150293551	1	519
NS006-5560	7314150293568	1	519
NS006-6065	7314150293575	1	519
NS006-6570	7314150293582	1	519
NS010-0607	7314150293599	1	520
NS010-0709	7314150293605	1	520
NS010-0809	7314150293612	1	520
NS010-0911	7314150293629	1	520
NS010-1011	7314150293636	1	520
NS010-1012	7314150293643	1	520
NS010-1214	7314150293650	1	520
NS010-1315	7314150293667	1	520
NS010-1417	7314150293674	1	520
NS010-1618	7314150293681	1	520
NS010-1719	7314150293698	1	520
NS010-1722	7314150293704	1	520
NS010-1819	7314150293711	1	520
NS010-1921	7314150293728	1	520
NS010-1922	7314150293735	1	520
NS010-2022	7314150293742	1	520
NS010-2123	7314150293759	1	520
NS010-2224	7314150293766	1	520
NS010-2427	7314150293773	1	520
NS010-2528	7314150293780	1	520
NS010-2628	7314150293797	1	520
NS010-2730	7314150293803	1	520
NS010-2732	7314150293810	1	520
NS010-3032	7314150293827	1	520
NS010-3036	7314150293834	1	520
NS010-3236	7314150293841	1	520
NS010-3641	7314150293858	1	520
NS010-4146	7314150293865	1	520
NS010-4650	7314150293872	1	520
NS011-0607	7314150317271	1	520
NS011-0809	7314150317288	1	520
NS011-1011	7314150317295	1	520
NS011-1213	7314150317301	1	520
NS011-1415	7314150317318	1	520
NS011-1617	7314150317325	1	520
NS011-1819	7314150317332	1	520
NS011-2022	7314150317349	1	520
NS011-2123	7314150317356	1	520
NS011-2426	7314150317363	1	520
NS011-2528	7314150317370	1	520
NS011-2729	7314150317387	1	520
NS011-3032	7314150317394	1	520
NS041-12-50	7314150502547	1	536
NS041-16-100	7314150502561	1	536
NS041-16-200	7314150502332	1	536
NS041-16-260	7314150502585	1	536
NS041-24-670	7314150502608	1	536
NS041-32-900	7314150502622	1	536
NS041-8-25	7314150502646	1	536
NS100-100	7314150294305	1	521
NS100-105	7314150294312	1	521
NS100-110	7314150294329	1	521
NS100-115	7314150294336	1	521
NS100-120	7314150294343	1	521
NS100-17	7314150293889	1	520
NS100-19	7314150293896	1	520
NS100-22	7314150293902	1	520
NS100-24	7314150293919	1	520
NS100-25	7314150293926	1	520
NS100-27	7314150293933	1	520
NS100-28	7314150293940	1	520
NS100-29	7314150293957	1	520
NS100-30	7314150293964	1	520
NS100-32	7314150293971	1	520
NS100-33	7314150293988	1	520
NS100-34	7314150293995	1	520
NS100-35	7314150294008	1	520
NS100-36	7314150294015	1	520
NS100-37	7314150294022	1	520
NS100-38	7314150294039	1	520
NS100-41	7314150294046	1	520
NS100-42	7314150294053	1	520
NS100-45	7314150294060	1	520
NS100-46	7314150294077	1	521
NS100-47	7314150294084	1	521
NS100-50	7314150294091	1	521
NS100-52	7314150294107	1	521
NS100-54	7314150294114	1	521
NS100-55	7314150294121	1	521
NS100-56	7314150294138	1	521
NS100-58	7314150294145	1	521
NS100-60	7314150294152	1	521
NS100-63	7314150294169	1	521
NS100-65	7314150294176	1	521
NS100-67	7314150294183	1	521
NS100-70	7314150294190	1	521
NS100-71	7314150294206	1	521
NS100-75	7314150294213	1	521
NS100-77	7314150294220	1	521
NS100-80	7314150294237	1	521
NS100-82	7314150294244	1	521



NS100-85	7314150294251	1	521
NS100-88	7314150294268	1	521
NS100-90	7314150294275	1	521
NS100-94	7314150294282	1	521
NS100-95	7314150294299	1	521
NS104-100	7314150294947	1	521
NS104-105	7314150294954	1	521
NS104-110	7314150294961	1	521
NS104-115	7314150294978	1	521
NS104-120	7314150294985	1	521
NS104-17	7314150294350	1	521
NS104-19	7314150294367	1	521
NS104-20	7314150294374	1	521
NS104-22	7314150294381	1	521
NS104-24	7314150284795	1	521
NS104-25	7314150294398	1	521
NS104-26	7314150294404	1	521
NS104-27	7314150284801	1	521
NS104-28	7314150294411	1	521
NS104-29	7314150294428	1	521
NS104-30	7314150284818	1	521
NS104-31	7314150294435	1	521
NS104-32	7314150284825	1	521
NS104-33	7314150294442	1	521
NS104-34	7314150294459	1	521
NS104-35	7314150294466	1	521
NS104-36	7314150284832	1	521
NS104-37	7314150294473	1	521
NS104-38	7314150294480	1	521
NS104-39	7314150294497	1	521
NS104-40	7314150294503	1	521
NS104-41	7314150284849	1	521
NS104-42	7314150294510	1	521
NS104-43	7314150294527	1	521
NS104-44	7314150294534	1	521
NS104-45	7314150294541	1	521
NS104-46	7314150284856	1	521
NS104-47	7314150294558	1	521
NS104-48	7314150294565	1	521
NS104-49	7314150294572	1	521
NS104-50	7314150284863	1	521
NS104-51	7314150294589	1	521
NS104-52	7314150294596	1	521
NS104-53	7314150294602	1	521
NS104-54	7314150294619	1	521
NS104-55	7314150284870	1	521
NS104-56	7314150294626	1	521
NS104-57	7314150294633	1	521
NS104-58	7314150294640	1	521
NS104-59	7314150294657	1	521
NS104-60	7314150284887	1	521
NS104-61	7314150294664	1	521
NS104-62	7314150294671	1	521
NS104-63	7314150294688	1	521
NS104-64	7314150294695	1	521
NS104-65	7314150294701	1	521
NS104-66	7314150294718	1	521
NS104-67	7314150294725	1	521
NS104-68	7314150294732	1	521
NS104-69	7314150294749	1	521
NS104-70	7314150284894	1	521
NS104-71	7314150294756	1	521
NS104-72	7314150294763	1	521
NS104-73	7314150294770	1	521
NS104-74	7314150294787	1	521
NS104-75	7314150284900	1	521
NS104-76	7314150294794	1	521
NS104-77	7314150294800	1	521
NS104-78	7314150294817	1	521
NS104-79	7314150294824	1	521
NS104-80	7314150284917	1	521
NS104-81	7314150294831	1	521
NS104-82	7314150294848	1	521
NS104-83	7314150294855	1	521
NS104-84	7314150294862	1	521
NS104-85	7314150284924	1	521
NS104-86	7314150294879	1	521
NS104-87	7314150294886	1	521
NS104-88	7314150294893	1	521
NS104-89	7314150294909	1	521
NS104-90	7314150284931	1	521
NS104-92	7314150294916	1	521
NS104-94	7314150294923	1	521
NS104-95	7314150284948	1	521
NS104-98	7314150294930	1	521
NS106-100	7314150295418	1	522
NS106-104	7314150295425	1	522
NS106-108	7314150295432	1	522
NS106-112	7314150295449	1	522
NS106-114	7314150295456	1	522
NS106-116	7314150295463	1	522
NS106-120	7314150295470	1	522
NS106-124	7314150295487	1	522
NS106-126	7314150295494	1	522
NS106-128	7314150295500	1	522
NS106-132	7314150295517	1	522



NS106-136	7314150295524	1	522
NS106-138	7314150295531	1	522
NS106-144	7314150295548	1	522
NS106-146	7314150295555	1	522
NS106-150	7314150295562	1	522
NS106-156	7314150295579	1	522
NS106-158	7314150295586	1	522
NS106-20	7314150294992	1	522
NS106-22	7314150295005	1	522
NS106-24	7314150295012	1	522
NS106-25	7314150295029	1	522
NS106-26	7314150295036	1	522
NS106-28	7314150295043	1	522
NS106-30	7314150295050	1	522
NS106-32	7314150295067	1	522
NS106-34	7314150295074	1	522
NS106-36	7314150295081	1	522
NS106-38	7314150295098	1	522
NS106-40	7314150295104	1	522
NS106-42	7314150295111	1	522
NS106-44	7314150295128	1	522
NS106-45	7314150295135	1	522
NS106-46	7314150295142	1	522
NS106-48	7314150295159	1	522
NS106-50	7314150295166	1	522
NS106-52	7314150295173	1	522
NS106-54	7314150295180	1	522
NS106-56	7314150295197	1	522
NS106-58	7314150295203	1	522
NS106-60	7314150295210	1	522
NS106-62	7314150295227	1	522
NS106-64	7314150295234	1	522
NS106-66	7314150295241	1	522
NS106-68	7314150295258	1	522
NS106-70	7314150295265	1	522
NS106-71	7314150295272	1	522
NS106-72	7314150295289	1	522
NS106-74	7314150295296	1	522
NS106-76	7314150295302	1	522
NS106-78	7314150295319	1	522
NS106-80	7314150295326	1	522
NS106-82	7314150295333	1	522
NS106-84	7314150295340	1	522
NS106-88	7314150295357	1	522
NS106-90	7314150295364	1	522
NS106-92	7314150295371	1	522
NS106-94	7314150295388	1	522
NS106-96	7314150295395	1	522
NS106-98	7314150295401	1	522
NS200-1200	7314150295661	1	523
NS200-200	7314150295593	1	523
NS200-250	7314150295609	1	523
NS200-300	7314150295616	1	523
NS200-350	7314150295623	1	523
NS200-450	7314150295630	1	523
NS200-600	7314150295647	1	523
NS200-900	7314150295654	1	523
NS202-350	7314150299690	1	523
NS203-200	7314150359509	1	523
NS203-215	7314150359516	1	523
NS203-290	7314150359523	1	523
NS203-400	7314150359530	1	523
NS203-490	7314150359547	1	523
NS203-800	7314150359554	1	523
NS204-30	7314150295685	1	523
NS204-32	7314150295692	1	523
NS204-35	7314150295708	1	523
NS204-40	7314150295715	1	523
NS204-45	7314150295722	1	523
NS204-48	7314150295739	1	523
NS204-50	7314150295746	1	523
NS204-55	7314150295753	1	523
NS204-60	7314150295760	1	523
NS204-65	7314150295777	1	523
NS204-70	7314150295784	1	523
NS204-75	7314150295791	1	523
NS204-80	7314150295807	1	523
NS204-85	7314150295814	1	523
NS204-90	7314150295821	1	523
NS220-06	7314150347216	1	524
NS220-07	7314150347223	1	524
NS220-08	7314150347230	1	524
NS220-09	7314150347247	1	524
NS220-10	7314150347254	1	524
NS220-11	7314150347261	1	524
NS220-12	7314150347278	1	524
NS220-13	7314150347285	1	524
NS220-14	7314150347292	1	524
NS220-15	7314150347308	1	524
NS220-16	7314150347315	1	524
NS220-17	7314150347322	1	524
NS220-18	7314150347339	1	524
NS220-19	7314150347346	1	524
NS220-20	7314150347353	1	524
NS220-21	7314150347360	1	524
NS220-22	7314150347377	1	524



NS220-23	7314150347384	1	524
NS220-24	7314150347391	1	524
NS220-25	7314150347407	1	524
NS220-26	7314150347414	1	524
NS220-27	7314150347421	1	524
NS220-28	7314150347438	1	524
NS220-29	7314150347445	1	524
NS220-30	7314150347452	1	524
NS220-32	7314150347469	1	524
NS220-34	7314150347476	1	524
NS220-36	7314150347483	1	524
NS220-41	7314150347490	1	524
NS224-17	7314150355525	1	524
NS224-18	7314150355532	1	524
NS224-19	7314150355549	1	524
NS224-21	7314150355556	1	524
NS224-22	7314150355563	1	524
NS224-23	7314150355570	1	524
NS224-24	7314150355587	1	524
NS224-26	7314150355594	1	524
NS224-27	7314150355617	1	524
NS224-28	7314150355624	1	524
NS224-29	7314150355631	1	524
NS224-30	7314150355648	1	524
NS224-32	7314150355655	1	524
NS224-34	7314150355662	1	524
NS224-36	7314150355679	1	524
NS224-38	7314150355686	1	524
NS224-41	7314150355693	1	524
NS224-46	7314150355709	1	524
NS224-50	7314150355716	1	524
NS228-22	7314150355914	1	525
NS228-24	7314150355921	1	525
NS228-26	7314150355938	1	525
NS228-27	7314150355945	1	525
NS228-28	7314150355952	1	525
NS228-29	7314150355969	1	525
NS228-30	7314150355976	1	525
NS228-31	7314150355983	1	525
NS228-32	7314150355990	1	525
NS228-34	7314150356003	1	525
NS228-36	7314150356010	1	525
NS228-38	7314150356027	1	525
NS228-41	7314150356034	1	525
NS228-46	7314150356041	1	525
NS228-50	7314150356058	1	525
NS228-55	7314150356065	1	525
NS228-60	7314150356072	1	525
NS228-65	7314150356089	1	525
NS228-70	7314150356096	1	525
NS228-75	7314150356102	1	525
NS228-80	7314150356119	1	525
NS232-16-24	7314150356331	1	525
NS232-24-16	7314150356355	1	525
NS232-24-32	7314150356348	1	525
NS232-32-24	7314150356362	1	525
NS234-16-100	7314150356416	1	525
NS234-16-200	7314150356423	1	525
NS234-16-250	7314150356430	1	525
NS234-24-200	7314150356447	1	525
NS234-32-250	7314150356454	1	525
NS236-16	7314150356522	1	525
NS236-24	7314150356539	1	525
NS236-32	7314150356515	1	525
NS238-16-250	7314150356577	1	526
NS238-24-250	7314150356584	1	526
NS238-32-300	7314150356591	1	526
NS240-16-230	7314150356737	1	526
NS242-16	7314150356638	1	526
NS242-24	7314150356645	1	526
NS242-32	7314150356652	1	526
NS243-16-400	7314150356690	1	526
NS247-26	7314150356751	1	527
NS248-16-52	7314150356713	1	527
NS300-10-200	7314150317783	1	527
NS300-10-300	7314150316205	1	527
NS300-11-250	7314150317790	1	527
NS300-11-300	7314150317806	1	527
NS300-11-350	7314150316212	1	527
NS300-12-400	7314150325153	1	527
NS300-13-450	7314150325160	1	527
NS300-3-50	7314150317677	1	527
NS300-3-75	7314150317684	1	527
NS300-4-75	7314150317691	1	527
NS300-4.5-100	7314150316175	1	527
NS300-4.5-50	7314150317707	1	527
NS300-5-100	7314150317721	1	527
NS300-5-75	7314150317714	1	527
NS300-6-100	7314150316182	1	527
NS300-6-125	7314150317738	1	527
NS300-6-150	7314150317745	1	527
NS300-7-150	7314150317752	1	527
NS300-8-150	7314150316199	1	527
NS300-8-200	7314150317769	1	527
NS300-9-250	7314150317776	1	527
NS301-10-200	7314150317882	1	527



NS301-10-300



NS301-10-300	7314150317899	1	527
NS301-3-50	7314150317813	1	527
NS301-4-100	7314150317820	1	527
NS301-4-150	7314150317837	1	527
NS301-5-100	7314150317844	1	527
NS301-5-200	7314150317851	1	527
NS301-6-100	7314150317868	1	527
NS301-8-150	7314150317875	1	527
NS302-0-50	7314150316229	1	528
NS302-1-100	7314150316236	1	528
NS302-2-125	7314150316243	1	528
NS302-3-150	7314150316250	1	528
NS302-4-300	7314150316267	1	528
NS304-0-50	7314150316274	1	528
NS304-1-100	7314150316281	1	528
NS304-2-125	7314150316298	1	528
NS304-3-150	7314150316304	1	528
NS304-4-300	7314150316311	1	528
NS320-10	7314150318162	1	528
NS320-2	7314150318087	1	528
NS320-3	7314150318094	1	528
NS320-4	7314150318100	1	528
NS320-5	7314150318117	1	528
NS320-6	7314150318124	1	528
NS320-7	7314150318131	1	528
NS320-8	7314150318148	1	528
NS320-9	7314150318155	1	528
NS400-160	7314150316106	1	528
NS400-180	7314150316113	1	528
NS400-200	7314150316120	1	528
NS402-160	7314150316137	1	529
NS402-200	7314150325177	1	529
NS403-160	7314150318209	1	529
NS403-180	7314150318193	1	529
NS404-160	7314150318216	1	529
NS405-160	7314150318247	1	529
NS406-160	7314150316144	1	529
NS406-180	7314150318261	1	529
NS406-200	7314150316151	1	529
NS407-160	7314150318278	1	529
NS408-250	7314150316168	1	530
NS408-300	7314150318292	1	530
NS411-200	7314150318322	1	530
NS412-200	7314150318339	1	530
NS413-180	7314150318384	1	530
NS413-200	7314150318377	1	530
NS500-1000-FB	7314150296019	1	531
NS500-1500-FB	7314150296026	1	531
NS500-2000	7314150291847	1	530
NS500-2000-FB	7314150284955	1	531
NS500-2500	7314150291854	1	530
NS500-2500-FB	7314150284962	1	531
NS500-3000	7314150291861	1	530
NS500-3000-FB	7314150284979	1	531
NS500-3500-FB	7314150284986	1	531
NS500-4000	7314150291878	1	530
NS502-1000-FB	7314150284993	1	531
NS502-10000-FB	7314150285068	1	531
NS502-12000-FB	7314150318407	1	531
NS502-1500-FB	7314150318438	1	531
NS502-2000-FB	7314150285006	1	531
NS502-2500-FB	7314150285013	1	531
NS502-3000-FB	7314150285020	1	531
NS502-450-FB	7314150296033	1	531
NS502-4500-FB	7314150285037	1	531
NS502-5000-FB	7314150285044	1	531
NS502-6800-FB	7314150318445	1	531
NS502-8000-FB	7314150285051	1	531
NS504-100-FB	7314150296040	1	531
NS504-1000-FB	7314150285099	1	531
NS504-1500-FB	7314150285105	1	531
NS504-200-FB	7314150296057	1	531
NS504-2000-FB	7314150285112	1	531
NS504-300-FB	7314150296064	1	531
NS504-500-FB	7314150285075	1	531
NS504-800-FB	7314150285082	1	531
NS506-300	7314150285129	1	531
NS506-300-FB	7314150318469	1	532
NS506-450	7314150285136	1	531
NS506-450-FB	7314150318476	1	532
NS506-700	7314150296071	1	531
NS506-700-FB	7314150285143	1	532
NS506-900	7314150296088	1	531
NS506-900-FB	7314150285150	1	532
NS508-500-FB	7314150318544	1	532
NS508-700-FB	7314150318537	1	532
NS512-200-FB	7314150318568	1	532
NS512-400-FB	7314150318575	1	532
NS512-600-FB	7314150318582	1	532
NS512-900-FB	7314150318599	1	532
NS600-100-50	7314150296101	1	532
NS600-135-50	7314150296118	1	532
NS600-150-25	7314150296125	1	532
NS600-150-30	7314150301676	1	532
NS600-150-40	7314150296132	1	532
NS600-150-50	7314150296149	1	532



NS600-180-13	7314150296156	1	532
NS600-180-32	7314150285167	1	532
NS600-180-50	7314150285174	1	532
NS600-200-20	7314150296163	1	532
NS600-200-30	7314150296170	1	532
NS600-200-40	7314150296187	1	532
NS600-200-50	7314150301782	1	532
NS600-230-40	7314150296194	1	532
NS600-250-40	7314150296200	1	532
NS600-300-50	7314150296217	1	532
NS600-80-13	7314150296095	1	532
NS602-460	7314150285181	1	533
NS602-600	7314150285198	1	533
NS602-760	7314150296224	1	533
NS602-900	7314150296231	1	533
NS604-150	7314150296248	1	533
NS604-200	7314150285204	1	533
NS604-300	7314150285211	1	533
NS606-150	7314150285228	1	533
NS606-200	7314150285235	1	533
NS606-250	7314150285242	1	533
NS606-300	7314150285259	1	533
NS606-400	7314150285266	1	533
NS608-100	7314150285273	1	533
NS700-300	7314150325184	1	533
NS702-200	7314150325191	1	534
NS704-225	7314150325207	1	534
NS706-50	7314150325214	1	534
NS706-80	7314150325221	1	534
NS708-360	7314150325238	1	534
NS710-450	7314150325245	1	535
NS800-1100	7314150296323	1	535
NS800-1700	7314150285280	1	535
NS800-2000	7314150296330	1	535
NS802-290	7314150285297	1	535
NS804-200	7314150296347	1	535
NS810-100	7314150318728	1	535
NS810-150	7314150318711	1	535
NS810-200	7314150318704	1	535
NS810-350	7314150318698	1	535
NSB001-150	7314150292509	5	518
NSB001-200	7314150284689	5	518
NSB001-250	7314150284696	5	518
NSB001-300	7314150284702	5	518
NSB001-375	7314150292516	5	518
NSB001-450	7314150292523	3	518
NSB001-600	7314150292530	3	518
NSB001-900	7314150292547	1	518
NSB002-10	7314150316366	5	518
NSB002-11	7314150316373	5	518
NSB002-12	7314150316380	5	518
NSB002-13	7314150316397	5	518
NSB002-14	7314150316403	5	518
NSB002-15	7314150316410	5	518
NSB002-16	7314150316427	5	518
NSB002-17	7314150316434	5	518
NSB002-18	7314150316441	5	518
NSB002-19	7314150316458	5	518
NSB002-20	7314150316465	5	518
NSB002-21	7314150316472	5	518
NSB002-22	7314150316489	5	518
NSB002-23	7314150316496	5	518
NSB002-24	7314150316502	5	518
NSB002-25	7314150316519	5	518
NSB002-26	7314150316526	5	518
NSB002-27	7314150316533	5	518
NSB002-28	7314150316540	5	518
NSB002-29	7314150316557	5	518
NSB002-30	7314150316564	5	518
NSB002-31	7314150321728	1	518
NSB002-32	7314150316571	10	518
NSB002-33	7314150321735	1	518
NSB002-34	7314150321742	1	518
NSB002-35	7314150321759	1	518
NSB002-36	7314150321766	5	518
NSB002-38	7314150321773	1	518
NSB002-40	7314150321780	1	518
NSB002-41	7314150321797	5	518
NSB002-42	7314150321803	1	518
NSB002-46	7314150321810	1	518
NSB002-50	7314150321827	1	518
NSB002-52	7314150321834	1	518
NSB002-55	7314150321841	1	518
NSB002-6	7314150316328	5	518
NSB002-60	7314150321858	1	518
NSB002-65	7314150321865	1	518
NSB002-7	7314150316335	5	518
NSB002-70	7314150321872	1	518
NSB002-75	7314150321889	1	518
NSB002-8	7314150316342	5	518
NSB002-80	7314150321896	1	518
NSB002-9	7314150316359	5	518
NSB003-10	7314150342709	1	518
NSB003-11	7314150342716	1	518
NSB003-12	7314150342723	5	518
NSB003-13	7314150342730	1	519



NSB003-14	7314150342747	1	519
NSB003-16	7314150342754	5	519
NSB003-18	7314150342761	1	519
NSB003-19	7314150342778	1	519
NSB003-20	7314150342785	1	519
NSB003-22	7314150342792	5	519
NSB003-24	7314150342808	5	519
NSB003-25	7314150342815	1	519
NSB003-26	7314150342822	1	519
NSB003-28	7314150342839	5	519
NSB003-30	7314150342846	1	519
NSB003-31	7314150342853	1	519
NSB003-32	7314150342860	1	519
NSB003-34	7314150342877	1	519
NSB003-36	7314150342884	1	519
NSB003-38	7314150342891	1	519
NSB003-40	7314150342907	1	519
NSB003-42	7314150342914	1	519
NSB003-44	7314150342921	5	519
NSB003-46	7314150342938	1	519
NSB003-48	7314150342945	1	519
NSB003-50	7314150342952	1	519
NSB003-52	7314150342969	1	519
NSB003-54	7314150342976	1	519
NSB003-56	7314150342983	1	519
NSB003-58	7314150342990	1	519
NSB003-60	7314150343010	1	519
NSB003-62	7314150343027	1	519
NSB003-64	7314150343034	5	519
NSB003-68	7314150343041	1	519
NSB003-72	7314150343058	1	519
NSB003-8	7314150342693	1	518
NSB003-80	7314150343065	1	519
NSB003-84	7314150343072	1	519
NSB003-88	7314150343089	1	519
NSB006-0607	7314150316588	1	519
NSB006-0608	7314150321926	1	519
NSB006-0708	7314150321933	1	519
NSB006-0709	7314150321940	1	519
NSB006-0809	7314150316595	1	519
NSB006-0810	7314150321957	1	519
NSB006-0910	7314150321964	1	519
NSB006-0911	7314150321971	1	519
NSB006-1011	7314150316601	1	519
NSB006-1012	7314150322015	1	519
NSB006-1013	7314150322022	1	519
NSB006-1014	7314150322039	1	519
NSB006-1113	7314150322046	1	519
NSB006-1114	7314150322053	1	519
NSB006-1213	7314150316618	1	519
NSB006-1214	7314150322060	1	519
NSB006-1315	7314150322077	1	519
NSB006-1415	7314150316625	1	519
NSB006-1416	7314150322084	1	519
NSB006-1417	7314150322091	1	519
NSB006-1617	7314150316632	1	519
NSB006-1618	7314150322107	1	519
NSB006-1719	7314150322114	1	519
NSB006-1722	7314150322121	1	519
NSB006-1819	7314150316649	1	519
NSB006-1820	7314150322138	1	519
NSB006-1920	7314150322145	1	519
NSB006-1922	7314150322152	1	519
NSB006-1924	7314150322169	1	519
NSB006-2022	7314150316656	1	519
NSB006-2122	7314150322176	1	519
NSB006-2123	7314150316663	1	519
NSB006-2223	7314150322183	1	519
NSB006-2224	7314150322190	1	519
NSB006-2227	7314150322206	1	519
NSB006-2326	7314150322213	1	519
NSB006-2425	7314150322220	1	519
NSB006-2426	7314150316670	1	519
NSB006-2427	7314150322237	1	519
NSB006-2430	7314150322244	1	519
NSB006-2528	7314150316687	1	519
NSB006-2629	7314150322251	1	519
NSB006-2729	7314150316694	1	519
NSB006-2730	7314150322336	1	519
NSB006-2732	7314150322343	1	519
NSB006-2830	7314150322350	1	519
NSB006-3031	7314150322367	1	519
NSB006-3032	7314150316700	1	519
NSB006-3034	7314150322374	1	519
NSB006-3036	7314150322381	1	519
NSB006-3234	7314150322398	1	519
NSB006-3235	7314150322404	1	519
NSB006-3236	7314150322411	1	519
NSB006-3335	7314150322428	1	519
NSB006-3436	7314150322435	1	519
NSB006-3536	7314150322442	1	519
NSB006-3638	7314150322459	1	519
NSB006-3641	7314150322466	1	519
NSB006-3642	7314150322473	1	519
NSB006-4146	7314150322480	1	519
NSB006-4650	7314150322497	1	519



NSB006-5052	7314150322503	1	519
NSB006-5055	7314150322510	1	519
NSB006-5060	7314150322527	1	519
NSB006-5062	7314150322534	1	519
NSB006-5560	7314150322558	1	519
NSB006-6065	7314150322565	1	519
NSB006-6570	7314150322572	1	519
NSB010-0607	7314150322589	1	520
NSB010-0709	7314150322596	1	520
NSB010-0809	7314150322602	1	520
NSB010-0911	7314150322619	1	520
NSB010-1011	7314150322626	1	520
NSB010-1012	7314150322633	1	520
NSB010-1214	7314150322640	1	520
NSB010-1315	7314150322657	1	520
NSB010-1417	7314150322664	1	520
NSB010-1618	7314150322671	1	520
NSB010-1719	7314150322688	1	520
NSB010-1722	7314150322695	1	520
NSB010-1819	7314150322718	1	520
NSB010-1921	7314150322725	1	520
NSB010-1922	7314150322732	1	520
NSB010-2022	7314150322749	1	520
NSB010-2123	7314150322756	1	520
NSB010-2224	7314150322763	1	520
NSB010-2427	7314150322770	1	520
NSB010-2528	7314150322787	1	520
NSB010-2628	7314150322794	1	520
NSB010-2730	7314150322800	1	520
NSB010-2732	7314150322817	1	520
NSB010-3032	7314150322824	1	520
NSB010-3036	7314150322831	1	520
NSB010-3236	7314150322848	1	520
NSB010-3641	7314150322855	1	520
NSB010-4146	7314150322862	1	520
NSB010-4650	7314150322879	1	520
NSB011-0607	7314150317400	1	520
NSB011-0809	7314150317417	1	520
NSB011-1011	7314150317424	1	520
NSB011-1213	7314150317431	1	520
NSB011-1415	7314150317448	1	520
NSB011-1617	7314150317455	1	520
NSB011-1819	7314150317462	1	520
NSB011-2022	7314150317479	1	520
NSB011-2123	7314150317486	1	520
NSB011-2426	7314150317493	1	520
NSB011-2528	7314150317509	1	520
NSB011-2729	7314150317516	1	520
NSB011-3032	7314150317523	1	520
NSB041-12-50	7314150502660	1	536
NSB041-16-100	7314150502684	1	536
NSB041-16-200	7314150502318	1	536
NSB041-16-260	7314150502707	1	536
NSB041-24-670	7314150502721	1	536
NSB041-32-900	7314150502745	1	536
NSB041-8-25	7314150502769	1	536
NSB100-100	7314150323302	1	521
NSB100-105	7314150323319	1	521
NSB100-110	7314150323326	1	521
NSB100-115	7314150323333	1	521
NSB100-120	7314150323340	1	521
NSB100-17	7314150322886	1	521
NSB100-19	7314150322893	1	521
NSB100-22	7314150322909	1	521
NSB100-24	7314150322916	1	521
NSB100-25	7314150322923	1	521
NSB100-27	7314150322930	1	521
NSB100-28	7314150322947	1	521
NSB100-29	7314150322954	1	521
NSB100-30	7314150322961	1	521
NSB100-32	7314150322978	1	521
NSB100-33	7314150322985	1	521
NSB100-34	7314150322992	1	521
NSB100-35	7314150323005	1	521
NSB100-36	7314150323012	1	521
NSB100-37	7314150323029	1	521
NSB100-38	7314150323036	1	521
NSB100-41	7314150323043	1	521
NSB100-42	7314150323050	1	521
NSB100-45	7314150323067	1	521
NSB100-46	7314150323074	1	521
NSB100-47	7314150323081	1	521
NSB100-50	7314150323098	1	521
NSB100-52	7314150323104	1	521
NSB100-54	7314150323111	1	521
NSB100-55	7314150323128	1	521
NSB100-56	7314150323135	1	521
NSB100-58	7314150323142	1	521
NSB100-60	7314150323159	1	521
NSB100-63	7314150323166	1	521
NSB100-65	7314150323173	1	521
NSB100-67	7314150323180	1	521
NSB100-70	7314150323197	1	521
NSB100-71	7314150323203	1	521
NSB100-75	7314150323210	1	521
NSB100-77	7314150323227	1	521



NSB100-80



NSB100-80	7314150323234	1	521
NSB100-82	7314150323241	1	521
NSB100-85	7314150323258	1	521
NSB100-88	7314150323265	1	521
NSB100-90	7314150323272	1	521
NSB100-94	7314150323289	1	521
NSB100-95	7314150323296	1	521
NSB104-100	7314150316885	1	522
NSB104-105	7314150316892	1	522
NSB104-110	7314150316908	1	522
NSB104-115	7314150323937	1	522
NSB104-120	7314150316915	1	522
NSB104-17	7314150323357	1	522
NSB104-19	7314150323364	1	522
NSB104-20	7314150323371	1	522
NSB104-22	7314150323388	1	522
NSB104-24	7314150316717	1	522
NSB104-25	7314150323395	1	522
NSB104-26	7314150323401	1	522
NSB104-27	7314150316724	1	522
NSB104-28	7314150323418	1	522
NSB104-29	7314150323425	1	522
NSB104-30	7314150316731	1	522
NSB104-31	7314150323432	1	522
NSB104-32	7314150316748	1	522
NSB104-33	7314150323449	1	522
NSB104-34	7314150323456	1	522
NSB104-35	7314150323463	1	522
NSB104-36	7314150316755	1	522
NSB104-37	7314150323470	1	522
NSB104-38	7314150323487	1	522
NSB104-39	7314150323494	1	522
NSB104-40	7314150323500	1	522
NSB104-41	7314150316762	1	522
NSB104-42	7314150323517	1	522
NSB104-43	7314150323524	1	522
NSB104-44	7314150323531	1	522
NSB104-45	7314150323548	1	522
NSB104-46	7314150316779	1	522
NSB104-47	7314150323555	1	522
NSB104-48	7314150323562	1	522
NSB104-49	7314150323579	1	522
NSB104-50	7314150316786	1	522
NSB104-51	7314150323586	1	522
NSB104-52	7314150323593	1	522
NSB104-53	7314150323609	1	522
NSB104-54	7314150323616	1	522
NSB104-55	7314150316793	1	522
NSB104-56	7314150323623	1	522
NSB104-57	7314150323630	1	522
NSB104-58	7314150323647	1	522
NSB104-59	7314150323654	1	522
NSB104-60	7314150316809	1	522
NSB104-61	7314150323661	1	522
NSB104-62	7314150323678	1	522
NSB104-63	7314150323685	1	522
NSB104-64	7314150323692	1	522
NSB104-65	7314150316816	1	522
NSB104-66	7314150323708	1	522
NSB104-67	7314150323715	1	522
NSB104-68	7314150323722	1	522
NSB104-69	7314150323739	1	522
NSB104-70	7314150316823	1	522
NSB104-71	7314150323746	1	522
NSB104-72	7314150323753	1	522
NSB104-73	7314150323760	1	522
NSB104-74	7314150323777	1	522
NSB104-75	7314150316830	1	522
NSB104-76	7314150323784	1	522
NSB104-77	7314150323791	1	522
NSB104-78	7314150323807	1	522
NSB104-79	7314150323814	1	522
NSB104-80	7314150316847	1	522
NSB104-81	7314150323821	1	522
NSB104-82	7314150323838	1	522
NSB104-83	7314150323845	1	522
NSB104-84	7314150323852	1	522
NSB104-85	7314150316854	1	522
NSB104-86	7314150323869	1	522
NSB104-87	7314150323876	1	522
NSB104-88	7314150323883	1	522
NSB104-89	7314150323890	1	522
NSB104-90	7314150316861	1	522
NSB104-92	7314150323906	1	522
NSB104-94	7314150323913	1	522
NSB104-95	7314150316878	1	522
NSB104-98	7314150323920	1	522
NSB106-100	7314150324361	1	523
NSB106-104	7314150324378	1	523
NSB106-108	7314150324385	1	523
NSB106-112	7314150324392	1	523
NSB106-114	7314150324408	1	523
NSB106-116	7314150324415	1	523
NSB106-120	7314150324422	1	523
NSB106-124	7314150324439	1	523
NSB106-126	7314150324446	1	523



NSB106-128	7314150324453	1	523
NSB106-132	7314150324460	1	523
NSB106-136	7314150324477	1	523
NSB106-138	7314150324484	1	523
NSB106-144	7314150324491	1	523
NSB106-146	7314150324507	1	523
NSB106-150	7314150324514	1	523
NSB106-156	7314150324521	1	523
NSB106-158	7314150324538	1	523
NSB106-20	7314150323944	1	522
NSB106-22	7314150323951	1	522
NSB106-24	7314150323968	1	522
NSB106-25	7314150323975	1	522
NSB106-26	7314150323982	1	522
NSB106-28	7314150323999	1	522
NSB106-30	7314150324002	1	522
NSB106-32	7314150324019	1	522
NSB106-34	7314150324026	1	522
NSB106-36	7314150324033	1	522
NSB106-38	7314150324040	1	522
NSB106-40	7314150324057	1	522
NSB106-42	7314150324064	1	522
NSB106-44	7314150324071	1	522
NSB106-45	7314150324088	1	522
NSB106-46	7314150324095	1	522
NSB106-48	7314150324101	1	522
NSB106-50	7314150324118	1	522
NSB106-52	7314150324125	1	522
NSB106-54	7314150324132	1	522
NSB106-56	7314150324149	1	522
NSB106-58	7314150324156	1	522
NSB106-60	7314150324163	1	522
NSB106-62	7314150324170	1	522
NSB106-64	7314150324187	1	523
NSB106-66	7314150324194	1	523
NSB106-68	7314150324200	1	523
NSB106-70	7314150324217	1	523
NSB106-71	7314150324224	1	523
NSB106-72	7314150324231	1	523
NSB106-74	7314150324248	1	523
NSB106-76	7314150324255	1	523
NSB106-78	7314150324262	1	523
NSB106-80	7314150324279	1	523
NSB106-82	7314150324286	1	523
NSB106-84	7314150324293	1	523
NSB106-88	7314150324309	1	523
NSB106-90	7314150324316	1	523
NSB106-92	7314150324323	1	523
NSB106-94	7314150324330	1	523
NSB106-96	7314150324347	1	523
NSB106-98	7314150324354	1	523
NSB200-1200	7314150324613	1	523
NSB200-200	7314150324545	1	523
NSB200-250	7314150324552	1	523
NSB200-300	7314150324569	1	523
NSB200-350	7314150324576	1	523
NSB200-450	7314150324583	1	523
NSB200-600	7314150324590	1	523
NSB200-900	7314150324606	1	523
NSB202-350	7314150324620	1	523
NSB203-200	7314150359561	1	523
NSB203-215	7314150359578	1	523
NSB203-290	7314150359585	1	523
NSB203-400	7314150359592	1	523
NSB203-490	7314150359608	1	523
NSB203-800	7314150359615	1	523
NSB204-30	7314150324637	1	524
NSB204-32	7314150324644	1	524
NSB204-35	7314150324651	1	524
NSB204-40	7314150324668	1	524
NSB204-45	7314150324675	1	524
NSB204-48	7314150324682	1	524
NSB204-50	7314150324699	1	524
NSB204-55	7314150324705	1	524
NSB204-60	7314150324712	1	524
NSB204-65	7314150324729	1	524
NSB204-70	7314150324736	1	524
NSB204-75	7314150324743	1	524
NSB204-80	7314150324750	1	524
NSB204-85	7314150324767	1	524
NSB204-90	7314150324774	1	524
NSB220-06	7314150354023	1	524
NSB220-07	7314150354030	1	524
NSB220-08	7314150354047	1	524
NSB220-09	7314150354054	1	524
NSB220-10	7314150354061	1	524
NSB220-11	7314150354078	1	524
NSB220-12	7314150354085	1	524
NSB220-13	7314150354092	1	524
NSB220-14	7314150354108	1	524
NSB220-15	7314150354115	1	524
NSB220-16	7314150354122	1	524
NSB220-17	7314150354139	1	524
NSB220-18	7314150354146	1	524
NSB220-19	7314150354153	1	524
NSB220-20	7314150354160	1	524



NSB220-21	7314150354177	1	524
NSB220-22	7314150354184	1	524
NSB220-23	7314150354191	1	524
NSB220-24	7314150354207	1	524
NSB220-25	7314150354214	1	524
NSB220-26	7314150354221	1	524
NSB220-27	7314150354238	1	524
NSB220-28	7314150354245	1	524
NSB220-29	7314150354252	1	524
NSB220-30	7314150354269	1	524
NSB220-32	7314150354276	1	524
NSB224-17	7314150355723	1	524
NSB224-18	7314150355730	1	524
NSB224-19	7314150355747	1	524
NSB224-21	7314150355754	1	524
NSB224-22	7314150355761	1	524
NSB224-23	7314150355778	1	524
NSB224-24	7314150355785	1	524
NSB224-26	7314150355792	1	524
NSB224-27	7314150355808	1	524
NSB224-28	7314150355815	1	524
NSB224-29	7314150355822	1	524
NSB224-30	7314150355839	1	524
NSB224-32	7314150355846	1	524
NSB224-34	7314150355853	1	524
NSB224-36	7314150355860	1	525
NSB224-38	7314150355877	1	525
NSB224-41	7314150355884	1	525
NSB224-46	7314150355891	1	525
NSB224-50	7314150355907	1	525
NSB228-22	7314150356126	1	525
NSB228-24	7314150356133	1	525
NSB228-26	7314150356140	1	525
NSB228-27	7314150356157	1	525
NSB228-28	7314150356164	1	525
NSB228-29	7314150356171	1	525
NSB228-30	7314150356188	1	525
NSB228-31	7314150356195	1	525
NSB228-32	7314150356201	1	525
NSB228-34	7314150356218	1	525
NSB228-36	7314150356225	1	525
NSB228-38	7314150356232	1	525
NSB228-41	7314150356249	1	525
NSB228-46	7314150356256	1	525
NSB228-50	7314150356263	1	525
NSB228-55	7314150356270	1	525
NSB228-60	7314150356287	1	525
NSB228-65	7314150356294	1	525
NSB228-70	7314150356300	1	525
NSB228-75	7314150356317	1	525
NSB228-80	7314150356324	1	525
NSB232-16-24	7314150356379	1	525
NSB232-24-16	7314150356393	1	525
NSB232-24-32	7314150356386	1	525
NSB232-32-24	7314150356409	1	525
NSB234-16-100	7314150356461	1	525
NSB234-16-200	7314150356478	1	525
NSB234-16-250	7314150356485	1	525
NSB234-24-200	7314150356492	1	525
NSB234-32-250	7314150356508	1	525
NSB236-16	7314150356553	1	526
NSB236-24	7314150356546	1	526
NSB236-32	7314150356560	1	526
NSB238-16-250	7314150356621	1	526
NSB238-24-250	7314150356614	1	526
NSB238-32-300	7314150356607	1	526
NSB240-16-230	7314150356744	1	526
NSB242-16	7314150356669	1	526
NSB242-24	7314150356676	1	526
NSB242-32	7314150356683	1	526
NSB243-16-400	7314150356706	1	526
NSB247-26	7314150356768	1	527
NSB248-16-52	7314150356720	1	527
NSB300-10-200	7314150317646	1	527
NSB300-10-300	7314150295845	1	527
NSB300-11-250	7314150317653	1	527
NSB300-11-300	7314150317660	1	527
NSB300-11-350	7314150295852	1	527
NSB300-12-400	7314150295869	1	527
NSB300-13-450	7314150295876	1	527
NSB300-3-50	7314150317530	1	527
NSB300-3-75	7314150317547	1	527
NSB300-4-75	7314150317554	1	527
NSB300-4.5-100	7314150295838	1	527
NSB300-4.5-50	7314150317561	1	527
NSB300-5-100	7314150317585	1	527
NSB300-5-75	7314150317578	1	527
NSB300-6-100	7314150285327	1	527
NSB300-6-125	7314150317592	1	527
NSB300-6-150	7314150317608	1	527
NSB300-7-150	7314150317615	1	527
NSB300-8-150	7314150285334	1	527
NSB300-8-200	7314150317622	1	527
NSB300-9-250	7314150317639	1	527
NSB301-10-200	7314150317974	1	528
NSB301-10-300	7314150317981	1	528



NSB301-3-50	7314150317905	1	528
NSB301-4-100	7314150317912	1	528
NSB301-4-150	7314150317929	1	528
NSB301-5-100	7314150317936	1	528
NSB301-5-200	7314150317943	1	528
NSB301-6-100	7314150317950	1	528
NSB301-8-150	7314150317967	1	528
NSB302-0-50	7314150295883	1	528
NSB302-1-100	7314150285341	1	528
NSB302-2-125	7314150285358	1	528
NSB302-3-150	7314150295890	1	528
NSB302-4-300	7314150295906	1	528
NSB304-0-50	7314150295913	1	528
NSB304-1-100	7314150295920	1	528
NSB304-2-125	7314150295937	1	528
NSB304-3-150	7314150295944	1	528
NSB304-4-300	7314150295951	1	528
NSB320-10	7314150318070	1	528
NSB320-2	7314150317998	1	528
NSB320-3	7314150318001	1	528
NSB320-4	7314150318018	1	528
NSB320-5	7314150318025	1	528
NSB320-6	7314150318032	1	528
NSB320-7	7314150318049	1	528
NSB320-8	7314150318056	1	528
NSB320-9	7314150318063	1	528
NSB400-160	7314150295968	1	528
NSB400-180	7314150285365	1	528
NSB400-200	7314150295975	1	528
NSB402-160	7314150295982	1	529
NSB402-200	7314150285372	1	529
NSB403-160	7314150318179	1	529
NSB403-180	7314150318186	1	529
NSB404-160	7314150318223	1	529
NSB405-160	7314150318230	1	529
NSB406-160	7314150295999	1	529
NSB406-180	7314150318254	1	529
NSB406-200	7314150296002	1	529
NSB407-160	7314150318285	1	530
NSB408-250	7314150285389	1	530
NSB408-300	7314150318308	1	530
NSB411-200	7314150318315	1	530
NSB412-200	7314150318346	1	530
NSB413-180	7314150318353	1	530
NSB413-200	7314150318360	1	530
NSB500-1000-FB	7314150324828	1	531
NSB500-1500-FB	7314150324835	1	531
NSB500-2000	7314150324781	1	530
NSB500-2000-FB	7314150324842	1	531
NSB500-2500	7314150324798	1	530
NSB500-2500-FB	7314150324859	1	531
NSB500-3000	7314150324804	1	530
NSB500-3000-FB	7314150324866	1	531
NSB500-3500-FB	7314150324873	1	531
NSB500-4000	7314150324811	1	530
NSB502-1000-FB	7314150316922	1	531
NSB502-1000-FB	7314150316991	1	531
NSB502-12000-FB	7314150318414	1	531
NSB502-1500-FB	7314150318421	1	531
NSB502-2000-FB	7314150316939	1	531
NSB502-2500-FB	7314150316946	1	531
NSB502-3000-FB	7314150316953	1	531
NSB502-450-FB	7314150324880	1	531
NSB502-4500-FB	7314150316960	1	531
NSB502-5000-FB	7314150316977	1	531
NSB502-6800-FB	7314150318452	1	531
NSB502-8000-FB	7314150316984	1	531
NSB504-100-FB	7314150317004	1	531
NSB504-1000-FB	7314150317059	1	531
NSB504-1500-FB	7314150317066	1	531
NSB504-200-FB	7314150317011	1	531
NSB504-2000-FB	7314150317073	1	531
NSB504-300-FB	7314150317028	1	531
NSB504-500-FB	7314150317035	1	531
NSB504-800-FB	7314150317042	1	531
NSB506-300	7314150324897	1	531
NSB506-300-FB	7314150318490	1	532
NSB506-450	7314150324903	1	531
NSB506-450-FB	7314150318483	1	532
NSB506-700	7314150324910	1	531
NSB506-700-FB	7314150317080	1	532
NSB506-900	7314150324927	1	531
NSB506-900-FB	7314150317097	1	532
NSB508-500-FB	7314150318513	1	532
NSB508-700-FB	7314150318520	1	532
NSB512-200-FB	7314150318643	1	532
NSB512-400-FB	7314150318636	1	532
NSB512-600-FB	7314150318629	1	532
NSB512-900-FB	7314150318605	1	532
NSB600-100-50	7314150317110	1	532
NSB600-135-50	7314150317127	1	532
NSB600-150-25	7314150317134	1	532
NSB600-150-30	7314150317141	1	532
NSB600-150-40	7314150317158	1	532
NSB600-150-50	7314150317165	1	532
NSB600-180-13	7314150317172	1	532



NSB600-180-32



NSB600-180-32	7314150317189	1	532
NSB600-180-50	7314150317196	1	532
NSB600-200-20	7314150317202	1	532
NSB600-200-30	7314150317219	1	532
NSB600-200-40	7314150317226	1	532
NSB600-200-50	7314150317233	1	532
NSB600-230-40	7314150317240	1	532
NSB600-250-40	7314150317257	1	532
NSB600-300-50	7314150317264	1	532
NSB600-80-13	7314150317103	1	532
NSB602-460	7314150324934	1	533
NSB602-600	7314150324941	1	533
NSB602-760	7314150324958	1	533
NSB602-900	7314150324965	1	533
NSB604-150	7314150324972	1	533
NSB604-200	7314150324989	1	533
NSB604-300	7314150324996	1	533
NSB606-150	7314150325009	1	533
NSB606-200	7314150325016	1	533
NSB606-250	7314150325023	1	533
NSB606-300	7314150325030	1	533
NSB606-400	7314150325047	1	533
NSB608-100	7314150325054	1	533
NSB700-300	7314150296255	1	534
NSB702-200	7314150296262	1	534
NSB704-225	7314150296279	1	534
NSB706-50	7314150296286	1	534
NSB706-80	7314150296293	1	534
NSB708-360	7314150296309	1	534
NSB710-450	7314150296316	1	535
NSB800-1100	7314150325061	1	535
NSB800-1700	7314150325078	1	535
NSB800-2000	7314150325085	1	535
NSB802-290	7314150325092	1	535
NSB810-100	7314150318650	1	535
NSB810-150	7314150318667	1	535
NSB810-200	7314150318674	1	535
NSB810-350	7314150318681	1	535
P-HB	7314150125272	25	556
P-MEC	7314150374342	24	557
P-MEC-LEAD	7314150374359	12	557
P1-20	7311518044572	5	635
P1-23	7311518332501	5	635
P108-20-F	7311518275518	2	635
P108-23-F	7311518275525	2	635
P11	7311518009076	6	646
P110-20-F	7311518275532	2	635
P110-23-F	7311518275549	2	635
P114-SL-40	7311518301149	2	639
P114-SL-50	7311518301156	2	639
P114-SL-60	7311518301163	2	639
P116-SL-40	7311518301101	2	639
P116-SL-50	7311518301118	2	639
P116-SL-60	7311518301125	2	639
P116-SL-70	7311518301132	2	639
P121-18-F	7311518275662	6	636
P121-20-F	7311518275631	6	636
P121-23-F	7311518275648	6	636
P123-19-BULK30	7311518218218	30	638
P126-19-F	7311518275297	6	636
P126-22-F	7311518275303	6	636
P127-19-BULK30	7311518199333	30	638
P128-19	7311518160814	6	638
P128-19-BULK30	7311518172329	30	638
P129-19-BULK30	7311518172336	30	638
P130-F	7311518333980	6	640
P138-22-F	7311518301279	6	636
P140-F	7311518275372	6	640
P16-40	7311518013479	2	639
P16-40W	7311518043049	2	639
P16-50-F	7311518301286	2	639
P16-60-F	7311518276461	2	639
P160-SL-60	7311518301170	2	639
P160-SL-75	7311518301187	1	639
P160-SL-90	7311518301194	1	639
P173-SL-85	7311518334703	1	639
P19-80-F	7311518275365	1	639
P20	7311518009281	6	646
P241	7311518008956	5	632
P262	7311518299286	10	630
P263	7311518299262	10	631
P264	7311518299279	10	631
P266	7311518299293	10	631
P267	7311518299309	10	631
P268	7311518299316	10	631
P269	7311518299323	10	632
P270	7311518299330	10	632
P272	7311518299354	5	630
P274	7311518299347	5	631



P276	7311518299361	5	631
P277	7311518299378	5	631
P278	7311518299385	5	631
P280-SL-60	7311518346508	2	639
P280-SL-80	7311518301330	2	639
P3-20-F	7311518275259	2	635
P3-23-F	7311518275266	2	635
P34-27A-F	7311518275464	2	642
P34-37	7311518002787	2	642
P5-23-F	7311518275280	2	635
P51-F	7311518275426	2	644
P51-SL	7311518301217	2	645
P51H-SL	7311518301224	2	645
P52-SL-20	7311518347307	2	645
P54-SL-20	7311518301248	2	645
P54-SL-25	7311518301231	2	645
P54H-SL-20	7311518301262	2	645
P54H-SL-25	7311518301255	2	645
P57-25-F	7311518301293	4	645
P57-25-W-F	7311518301309	4	645
P59-25-F	7311518275655	6	645
P64-20	7311518288174	6	636
P64-20-BULK12	7311518288204	12	636
P74	7311518124076	1	646
P75	7311518124083	1	646
PAGS-2.0	7311518327835	1	615
PAGS-2.0-900FG	7311518292355	1	615
PBB-8	7314150399376	8	556
PBS-700	7314150341689	6	556
PC-10-DTF	7311518263560	10	580
PC-10-DTL	7311518263553	10	580
PC-10-DTR	7311518263546	10	580
PC-11-19-PS	7311518285548	4	579
PC-11-19-PS-B	7311518285555	10	579
PC-12-14-PS	7311518285562	4	579
PC-12-14-PS-B	7311518285579	10	579
PC-12-COM	7311518263454	4	574
PC-12-TEN	7311518263447	4	578
PC-12-VEN	7311518263430	4	578
PC-15-GBP	73115182634307	4	574
PC-15-TBX	7311518263423	4	578
PC-16-DECO	7311518264987	4	575
PC-16-FILE-U7	7311518263461	4	576
PC-19-FILE-U7	7311518263478	4	576
PC-19-GT7	7311518263362	4	576
PC-19-GT9	7311518263379	4	578
PC-20-LAM	7311518258290	4	577
PC-20-PRC	7311518264291	4	578
PC-22-FILE-U7	7311518263485	4	576
PC-22-GT7	7311518263393	4	576
PC-22-GT9	7311518263409	4	578
PC-22-INS	7314150154500	4	575
PC-22-PLC	7314150276318	4	574
PC-24-FILE-U7	7311518263492	4	576
PC-24-PLS	7311518263508	4	574
PC-24-TIM	7311518263515	4	579
PC-6-DRY	7311518282004	6	574
PC-9-9/17-PS	7311518285586	4	579
PC-9-9/17-PS-B	7311518285593	10	579
PENCIL-200-DISP	7314150125227	1	557
PG-01-F	7311518329334	6	636
PG-03-L	7311518242855	2	636
PG-12-BULK15	7311518334628	15	636
PG-12-F	7311518328122	10	636
PG-18-45-F	7311518299033	2	640
PG-18-60-F	7311518288853	2	640
PG-19-F	7311518295936	2	640
PG-56-F	7311518288938	2	645
PG-57-F	7311518295943	2	645
PG-72	7311518242534	4	649
PH-6604-1P	7311518152819	15	35
PH-6604-25	7311518141134	25	35
PROF-H	7311518158439	2	651
PROF-LOPP	7311518288549	1	651
PROF-SEC	7311518288532	1	651
PROF-TL	7311518335991	4	477
PU-14	7314150016266	5	44
PU-20	7314150016389	3	44
PU-22	7314150016426	3	44
PU-24	7314150016464	3	44
PU-6	7314150016105	5	44
PU-9	7314150016167	5	44
PX-L2	7311518233853	2	634
PX-L3	7311518233860	2	634
PX-M1	7311518233815	2	634
PX-M2	7311518233822	2	634
PX-M2-L	7311518240714	2	634
PX-M3	7311518233839	2	634
PX-S1	7311518233785	2	634



PX-S2	7311518233792	2	634
PXR-L2	7311518233914	2	634
PXR-M1	7311518233877	2	634
PXR-M2	7311518233884	2	634
PXR-M2-L	7311518240738	2	634
PXR-M3	7311518233891	2	634
PXR-S1	7311518240677	2	634
PXR-S2	7311518240684	2	634
PXR-S2-L	7311518346799	2	634
QC-115A	7314150460007	12	602
QC-115A-2P	7314150460021	6	602
QC-150A	7314150460045	6	602
QC-150A-2P	7314150460069	6	602
QC-300A	7314150401925	6	602
QC-300A-2P	7314150460090	4	602
QCB-1250	7314150135981	8	602
QCB-150	7314150135912	6	602
QCB-300	7314150135936	6	602
QCB-450	7314150135950	6	602
QCB-600	7314150135967	4	602
QCB-900	7314150135974	4	602
QCG-150	7314150135899	6	602
QCG-300	7314150135905	6	602
R1068	7311518044398	1	638
R1069P	7311518219574	12	638
R1071	7311518222918	14	639
R1075-BULK50	7311518220495	50	639
R1080P	7311518282479	1	638
R112PG	7311518010058	1	637
R113PG	7311518044374	30	637
R114PG	7311518010065	1	637
R114V	7311518042660	25	640
R114V-BULK28	7311518177539	28	640
R115V	7311518243210	8	640
R115V-BULK14	7311518288341	14	640
R116V	7311518010164	1	640
R116V-BULK36	7311518159924	36	640
R116VP	7311518042721	25	640
R119V	7311518029487	1	640
R122PG	7311518010072	30	637
R123PG	7311518044381	30	637
R124PG	7311518010089	30	637
R1269P-BULK50	7311518240820	50	635
R133PG	7311518328252	1	643
R137E	7311518011574	30	642
R142P	7311518010126	24	637
R143PV	7311518010133	1	640
R143PVCB	7311518255633	1	640
R144PV	7311518291075	24	640
R146VC	7311518046545	22	646
R146VS	7311518046538	24	640
R146VS-BULK50	7311518159955	50	640
R147V	7311518044909	24	646
R1601	7311518044640	1	638
R160A	7311518201821	1	640
R160A-BULK28	7311518337216	28	640
R166V	7311518328085	22	640
R16V	7311518254513	1	640
R16V-BULK14	7311518288334	14	640
R172A	7311518235413	1	640
R181P	7311518296087	1	640
R185V	7311518331795	25	640
R201P	7311518219536	1	636
R201P-BULK80	7311518225209	80	636
R202P	7311518219550	1	637
R211P	7311518234027	1	634
R211P-BULK80	7311518252212	80	634
R214SL	7311518301392	1	640
R214V	7311518042745	1	640
R214V-BULK28	7311518177553	28	640
R215V	7311518243227	1	640
R216SL	7311518301408	8	640
R221P	7311518229412	1	636
R221P-BULK50	7311518240653	50	636
R223P	7311518237554	1	637
R223P-BULK80	7311518240646	80	637
R230P	7311518341503	10	642
R239P	7311518219567	1	637
R260A	7311518201814	16	640
R272H	7311518258016	1	641
R300P	7311518234034	1	634
R301P	7311518349189	30	636
R303P	7311518234157	1	634
R304P	7311518349219	1	637
R310-0	7314151829797	1	56
R310-1	7314151829803	1	56
R310-2	7314151829810	1	56
R310-3	7314151829827	1	56
R312V	7311518235420	1	640



R315V	7311518243234	1	640
R318V	7311518029500	1	640
R328V	7311518296056	22	640
R335V	7311518331801	12	640
R337E	7311518011598	1	643
R341P	7311518011529	12	637
R372H	7311518235406	1	640
R373A	7311518334710	25	640
R403P	7311518234164	1	634
R415V	7311518243241	1	641
R4230	7311518341510	10	642
R427AE	7311518176068	18	643
R437E	7311518011611	18	643
R438P	7311518229429	1	637
R438P-BULK50	7311518240660	50	637
R440V	7311518254544	22	640
R444V	7311518243340	22	646
R463P	7311518223908	1	637
R472H	7311518334840	30	641
R474P	7311518011536	1	637
R478P	7311518275600	1	638
R480P	7311518282486	1	638
R500P	7311518234041	40	634
R503P	7311518234171	1	634
R515VS	7311518046514	22	646
R516V	7311518200824	22	646
R519V	7311518029517	1	641
R600P	7311518240783	1	634
R603P	7311518240790	1	634
R615V	7311518010119	1	641
R619V	7311518029494	1	640
R660V	7311518210281	24	641
R6725MK	7314151088354	1	69
R6725ZK	7314151784898	1	69
R680V	7311518042752	1	640
R6810M-10	7314150195152	5	80
R6810M-3,4	7314150195077	5	80
R6810M-4	7314150195084	5	80
R6810M-4,5	7314150195091	5	80
R6810M-5	7314150195107	5	80
R6810M-6	7314150195114	5	80
R6810M-7	7314150195121	1	80
R6810M-8	7314150195138	5	80
R6810M-9	7314150195145	5	80
R6810Z-1/4	7314150429448	1	80
R6810Z-3/16	7314150429387	1	80
R6810Z-3/8	7314150429394	1	80
R6810Z-5/16	7314150429400	1	80
R6810Z-7/32	7314150429417	1	80
R6822Z	7314150429424	5	80
R6950	7314151089658	1	85
R6964A	7314150195176	1	80
R6967	7314150195169	5	80
R716VCB	7311518255497	40	640
R772V	7311518301385	14	641
R773V	7311518324414	1	641
R775V	7311518331818	1	641
R776V	7311518334734	1	641
R801P	7311518234126	1	634
R802P	7311518234133	1	634
R803P	7311518234140	1	634
R804P	7311518240806	1	634
R811P	7311518234058	1	634
R812P	7311518234065	1	634
R813P	7311518234072	1	634
R815P	7311518240752	1	634
R900P	7311518234188	1	634
R900P-Z	7311518349233	24	637
R901P	7311518234195	30	634
R902P	7311518234201	24	635
R903P	7311518234218	1	635
R904P	7311518234225	1	635
R905P	7311518234232	1	635
R905P-BULK50	7311518252250	50	635
R906P	7311518234249	1	635
R906P-BULK50	7311518252267	50	635
R906P-Z	7311518349264	12	637
R907P	7311518234256	1	635
RAIL-187	7314153003621	3	84
RAIL-264	7314153003638	3	84
RAIL-340	7314153003645	3	84
RAUNI	7311518339289	6	641
RB-SET-AL06-5P	7314150501489	1	148
RB-SET-M06X-10P	7314150501557	1	148
RB-SET-1-M06X-5P	7314150501588	1	148
RB-SET-2-M06X-5P	7314150501618	1	148
RBCP	7311518339272	10	643
RBCP230	7311518341558	12	643
RCAM30	7311518346959	20	643





RCAM36	7311518346973	20	643
RD1M	7311518341534	15	643
RD7M	7311518341541	20	643
RPL230G	7311518341527	8	643
RS1000	7314150467235	1	356
RS1000PS0	7314150508938	1	357
RS1000PS1	7314150487370	1	357
RS1000TOP1	7314150470662	1	357
RS1000TOP2	7314150487387	1	357
RT821P	7311518242237	1	634
RT822P	7311518234102	1	634
RT823P	7311518234119	6	634
RT824P	7311518240776	1	634
RT825P	7311518347147	6	634
S0810L	7314150256594	20	63
S103	7314150257119	2	62
S103-CASE	7314150321261	1	104
S106	7314150103997	2	62
S108	7314150122257	2	62
S108-CASE	7314150349319	1	104
S1214L	7314150256600	10	69
S137	7314150450503	2	63
S138	7314150195022	2	63
S140T	7314150125203	1	70
S140T-R	7314150136353	10	70
S160	7314150104031	6	64
S160-CASE	7314150136209	1	104
S160AF	7314150137510	6	65
S1612L	7314150256617	4	72
S18HEX	7314150412457	4	73
S18TORX	7314150412464	4	73
S240	7314150104017	4	73
S240AF	7314150111077	4	73
S240AF-CASE	7314150187317	1	104
S290	7314153000859	6	64
S290-CASE	7314150126385	1	104
S330	7314150104024	6	69
S330-CASE	7314150136223	1	104
S330AF	7314150137503	6	70
S330L	7314150256587	4	69
S330L-CASE	7311518337674	1	104
S350AF	7314150137527	2	73
S380	7314150168934	4	69
S400	7314150111053	2	73
S400-CASE	7314150187300	1	104
S410	7314153019370	2	62
S410-CASE	7314150321223	1	104
S460	7314150111060	6	64
S460-CASE	7314150321209	1	104
S4RM-12-15	7314150179954	1	47
S4RM-16-19	7314150179961	1	47
S4RM-21-27	7314150179978	1	47
S4RM-30-36	7314150179985	1	47
S4RM-4-7	7314150179930	1	47
S4RM-8-11	7314150179947	1	47
S4RM/3T	7314150117406	20	47
S4RM/4T	7314150179916	1	47
S4RM/5T	7314150179923	1	48
S530T	7314150169122	4	70
S560	7314150122264	4	63
S560-CASE	7314150321216	1	104
S800	7314150165599	2	62
S81MIX	7314150180127	2	62
S81MIX-CASE	7314150321247	1	104
S87+7	7314150103980	2	62
S910	7314150104000	2	62
S910AF	7314150137541	2	63
S93	7314150129805	1	101
S95	7314150409167	2	62
S9HEX	7314150412433	10	72
S9TORX	7314150412440	10	72
SB-2058/S26	7314151849498	1	168
SB-2444	7314150189250	1	597
SB-2448	7314150136056	12	586
SB-2449	7314150194049	10	586
SB-3732-2-125	7314151847869	60	622
SB-3732-2.5-125	7314151847876	60	622
SB-3732-3.2-125	7314151847883	60	622
SB-3732-4-125	7314151847890	1	622
SB-3734N-10-150	7314151848101	1	621
SB-3734N-2-150	7314151847968	1	621
SB-3734N-3-150	7314151847975	1	621
SB-3734N-4-150	7314151847982	60	621
SB-3734N-5-150	7314151847999	1	621
SB-3734N-6-150	7314151848071	60	621
SB-3734N-7-150	7314151848088	1	621
SB-3734N-8-150	7314151848095	1	621
SB-3735N-2-100	7314151847906	1	620
SB-3735N-4-120	7314151847913	60	620



SB-3735N-5-120	7314151847920	1	620
SB-3735N-6-150	7314151847937	1	620
SB-3735N-8-150	7314151847944	1	620
SB-3740-125	7314150115990	87	618
SB-3740-150	7314150116003	25	618
SB-3740-175	7314150116010	25	618
SB-3740-200	7314150116027	25	618
SB-3740-250	7314150116034	25	618
SB-3740-300	7314150116041	25	618
SB-9526/S6	7314150154234	20	154
SB111M-10	7314151839864	1	40
SB111M-11	7314151839871	1	40
SB111M-12	7314151839888	1	40
SB111M-13	7314151839895	1	40
SB111M-14	7314151839901	1	40
SB111M-15	7314151839918	1	40
SB111M-16	7314151839925	1	41
SB111M-17	7314151839932	1	41
SB111M-18	7314151839949	1	41
SB111M-19	7314151839956	1	41
SB111M-20	7314151839963	1	41
SB111M-21	7314151839970	1	41
SB111M-22	7314151839987	1	41
SB111M-23	7314151839994	1	41
SB111M-24	7314151840006	1	41
SB111M-25	7314151840013	1	41
SB111M-26	7314151840020	1	41
SB111M-27	7314151840037	1	41
SB111M-28	7314150432103	1	41
SB111M-29	7314151840051	1	41
SB111M-30	7314151840068	1	41
SB111M-32	7314151840075	1	41
SB111M-5.5	7314151839819	1	40
SB111M-6	7314151839826	1	40
SB111M-7	7314151839833	1	40
SB111M-8	7314151839840	1	40
SB111M-9	7314151839857	1	40
SB141.007.075	7314150282753	1	202
SB141.008.075	7314150282760	1	202
SB141.009.075	7314150282777	1	202
SB141.010.075	7314150282784	1	202
SB141.015.100	7314150282791	1	202
SB141.020.100	7314150282807	1	202
SB141.025.125	7314150282814	1	202
SB141.027.125	7314150282821	1	202
SB141.030.150	7314150282838	1	202
SB141.040.150	7314150282845	1	202
SB142.000.075	7314150282579	1	506
SB142.001.080	7314150282586	1	506
SB142.002.100	7314150282593	1	506
SB142.003.150	7314150282609	1	506
SB143.020.100	7314150282852	1	202
SB143.025.100	7314150282869	1	202
SB143.030.100	7314150282876	1	202
SB143.040.100	7314150282883	1	202
SB143.050.100	7314150282890	1	202
SB143.060.125	7314150282906	1	202
SB143.080.150	7314150282913	1	202
SB144.001.100	7314150282951	1	202
SB144.002.125	7314150282968	1	202
SB144.003.150	7314150282975	1	202
SB145.006.100	7314150282920	1	203
SB146.006.100	7314150282937	1	203
SB148.001.080	7314150314577	1	506
SB148.002.100	7314150314584	1	506
SB149.001.080	7314150314591	1	506
SB149.002.100	7314150314607	1	506
SB150.010.100	7314150343492	1	506
SB150.015.125	7314150343515	1	506
SB150.020.125	7314150343577	1	506
SB150.025.150	7314150343584	1	506
SB190.040.075	7314150281985	1	200
SB190.040.100	7314150282098	1	200
SB190.055.100	7314150281992	1	200
SB190.055.125	7314150282005	1	200
SB190.065.125	7314150282012	1	200
SB190.065.150	7314150282029	1	200
SB190.080.150	7314150282036	1	200
SB190.080.175	7314150282043	1	200
SB190.100.200	7314150282050	1	200
SB190.120.250	7314150282067	1	200
SB190.140.250	7314150282074	1	200
SB191.025.075	7314150282081	1	200
SB191.030.075	7314150282104	1	200
SB191.030.100	7314150282111	1	200
SB191.030.200	7314150282128	1	200
SB191.035.100	7314150282135	1	200
SB191.040.100	7314150282142	1	200
SB191.040.125	7314150282159	1	200



SB191.040.250	7314150282166	1	200
SB191.055.125	7314150282173	1	200
SB191.055.150	7314150282180	1	200
SB191.055.300	7314150282197	1	200
SB191.065.150	7314150282203	1	200
SB191.065.300	7314150282210	1	200
SB192.000.075	7314150282357	1	201
SB192.000.200	7314150282364	1	201
SB192.001.100	7314150282371	1	201
SB192.001.250	7314150282388	1	201
SB192.002.125	7314150282395	1	201
SB192.002.300	7314150282401	1	201
SB192.003.150	7314150282418	1	201
SB192.004.200	7314150282425	1	201
SB193.000.075	7314150282456	1	201
SB193.001.100	7314150282463	1	201
SB193.002.125	7314150282470	1	201
SB193.003.150	7314150282487	1	201
SB193.004.200	7314150282494	1	201
SB194.004.075	7314150282616	1	202
SB194.005.075	7314150282623	1	202
SB194.006.075	7314150282630	1	202
SB194.007.075	7314150282647	1	202
SB194.008.075	7314150282654	1	202
SB194.009.075	7314150282661	1	202
SB194.010.075	7314150282678	1	202
SB194.015.100	7314150282685	1	202
SB194.020.100	7314150282692	1	202
SB194.025.125	7314150282708	1	202
SB194.027.125	7314150282715	1	202
SB194.030.150	7314150282722	1	202
SB194.040.150	7314150282739	1	202
SB194.045.150	7314150282746	1	202
SB195.001.025	7314150282432	1	201
SB195.002.025	7314150282449	1	201
SB195.006.050	7314150289516	1	203
SB195.040.025	7314150282227	1	200
SB195.050.025	7314150282234	1	200
SB195.060.025	7314150282241	1	200
SB195.901.025	7314150282500	1	201
SB195.902.025	7314150282517	1	201
SB1952M-10	7314150105205	1	43
SB1952M-12	7314150105229	1	43
SB1952M-13	7314150105236	1	43
SB1952M-14	7314150105243	1	43
SB1952M-17	7314150105274	1	43
SB1952M-19	7314150105298	1	43
SB1952M-24	7314150105342	1	43
SB1952M-7	7314150105441	1	43
SB1952M-8	7314150105458	1	43
SB196.025.075	7314150282258	1	505
SB196.030.100	7314150282265	1	505
SB196.035.100	7314150282272	1	505
SB196.040.100	7314150282289	1	505
SB196.055.125	7314150282296	1	505
SB196.065.150	7314150282302	1	505
SB196.080.175	7314150282326	1	505
SB196.100.200	7314150282333	1	505
SB196.120.200	7314150282340	1	505
SB197.000.075	7314150282524	1	506
SB197.001.080	7314150282531	1	506
SB197.002.100	7314150282548	1	506
SB197.003.150	7314150282555	1	506
SB197.004.200	7314150282562	1	506
SB198.040.125	7314150282982	1	203
SB198.045.125	7314150282999	1	203
SB198.050.150	7314150283002	1	203
SB198.055.150	7314150283019	1	203
SB198.060.150	7314150283026	1	203
SB198.060.150F	7314150283033	1	203
SB198.070.150	7314150283040	1	203
SB198.070.150F	7314150283057	1	203
SB198.080.150	7314150283064	1	203
SB198.080.150F	7314150283071	1	203
SB198.090.150	7314150283088	1	203
SB198.100.150	7314150283095	1	203
SB198.110.150	7314150283101	1	203
SB198.120.150	7314150283118	1	203
SB198.130.150	7314150283125	1	203
SB198.140.150	7314150283132	1	203
SB199.055.125	7314150283149	1	506
SB199.060.125	7314150283156	1	506
SB199.070.125	7314150283163	1	506
SB199.080.125	7314150283170	1	506
SB199.090.125	7314150283187	1	506
SB199.100.125	7314150283194	1	506
SB199.110.125	7314150283200	1	506
SB199.120.125	7314150287765	1	506
SB199.130.125	7314150287796	1	506



SB2446-EL	7314150312207	10	598
SB27M-10-11	7314150180851	10	58
SB27M-12-13	7314150180868	10	58
SB27M-14-15	7314150180875	10	58
SB27M-16-17	7314150180882	10	58
SB27M-18-19	7314150180899	10	58
SB27M-20-22	7314150180905	10	58
SB27M-21-23	7314150180912	5	58
SB27M-24-26	7314150180929	5	58
SB27M-6-7	7314150180837	10	58
SB27M-8-9	7314150180844	10	58
SB28M-10	7314150485987	10	56
SB28M-11	7314150486007	10	56
SB28M-12	7314150486021	10	56
SB28M-13	7314150486045	10	56
SB28M-14	7314150486052	10	56
SB28M-15	7314150486076	10	56
SB28M-16	7314150486090	5	56
SB28M-17	7314150486113	5	56
SB28M-18	7314150486137	5	56
SB28M-19	7314150486151	5	56
SB28M-20	7314150486854	4	56
SB28M-21	7314150486878	4	56
SB28M-22	7314150486892	4	56
SB28M-23	7314150486915	4	56
SB28M-24	7314150486939	4	56
SB28M-6	7314150486175	10	56
SB28M-7	7314150486199	10	56
SB28M-8	7314150486212	10	56
SB28M-9	7314150486236	10	56
SB3654BM-15	7314150270897	5	624
SB3654BM-20	7314150270903	5	624
SB3734BM-10	7314150271092	5	624
SB3734BM-3	7314150270996	5	624
SB3734BM-4	7314150271016	5	624
SB3734BM-5	7314150271030	5	624
SB3734BM-6	7314150271054	5	624
SB3734BM-8	7314150271078	5	624
SB3755BM-4	7314150270934	1	624
SB3755BM-6	7314150270958	5	624
SB6700SM-10	7314150104383	1	79
SB6700SM-11	7314150104390	1	79
SB6700SM-12	7314150104406	1	79
SB6700SM-13	7314150104413	1	79
SB6700SM-14	7314150104420	1	79
SB6700SM-4	7314150104307	1	79
SB6700SM-4.5	7314150104314	1	79
SB6700SM-5	7314150104321	1	79
SB6700SM-5.5	7314150104338	1	79
SB6700SM-6	7314150104345	1	79
SB6700SM-7	7314150104352	1	79
SB6700SM-8	7314150104369	1	79
SB6700SM-9	7314150104376	1	79
SB6700SZ-1/2	7314150240609	1	80
SB6700SZ-1/4	7314150240616	1	80
SB6700SZ-1/8	7314150412495	5	80
SB6700SZ-11/32	7314150240623	1	80
SB6700SZ-3/16	7314150240630	1	80
SB6700SZ-3/8	7314150240647	1	80
SB6700SZ-5/16	7314150240654	1	80
SB6700SZ-5/32	7314150240661	1	80
SB6700SZ-7/16	7314150240678	1	80
SB6700SZ-7/32	7314150240685	1	80
SB6700SZ-9/16	7314150240692	1	80
SB6700SZ-9/32	7314150240708	1	80
SB6700TORX-E10	7314150240715	1	80
SB6700TORX-E4	7314150240722	1	80
SB6700TORX-E5	7314150240739	1	80
SB6700TORX-E6	7314150240746	1	80
SB6700TORX-E7	7314150240753	1	80
SB6700TORX-E8	7314150240760	1	80
SB6709F-4.5	7314150240777	1	84
SB6709F-5.5	7314150240784	1	84
SB6709F-6.5	7314150240791	1	84
SB6709F-8	7314150240807	1	84
SB6709M-3	7314150240814	1	85
SB6709M-4	7314150240821	1	85
SB6709M-5	7314150240838	1	85
SB6709M-6	7314150240845	1	85
SB6709M-8	7314150240852	1	85
SB6709PH-1	7314150240869	1	84
SB6709PH-2	7314150240876	1	84
SB6709PH-3	7314150240883	1	84
SB6709PZ-1	7314150240890	1	84
SB6709PZ-2	7314150240906	1	84
SB6709PZ-3	7314150240913	1	84
SB6709TORX-R-T10	7314150240975	1	84
SB6709TORX-R-T15	7314150240937	1	84
SB6709TORX-R-T20	7314150240944	1	84



SB6709TORX-R-T25



SB6709TORX-R-T25	7314150240951	1	84
SB6709TORX-R-T8	7314150240968	1	84
SB6709TORX-T10	7314150240982	1	84
SB6709TORX-T15	7314150240999	1	84
SB6709TORX-T20	7314150241002	1	84
SB6709TORX-T25	7314150241019	1	84
SB6709TORX-T27	7314150241026	1	84
SB6709TORX-T30	7314150241033	1	84
SB6709TORX-T40	7314150241040	1	84
SB6709TORX-T8	7314150241057	1	84
SB6709TORX-T9	7314150241064	1	84
SB6950	7314150104987	1	85
SB6950RN	7314150104994	1	85
SB6954	7314150250158	10	82
SB6956	7314150241071	1	82
SB6958-6	7314150500833	1	82
SB6960	7314150104925	1	82
SB6961	7314150104932	1	82
SB6962	7314150104949	1	82
SB6962L	7314150254743	1	82
SB6963	7314150241088	1	82
SB6966	7314150241095	1	82
SB6973A	7314150507214	1	83
SB6M-10-11	7314150105731	1	48
SB6M-12-13	7314150105762	1	48
SB6M-14-15	7314150105823	1	48
SB6M-16-17	7314150105847	1	48
SB6M-17-19	7314150189830	1	48
SB6M-18-19	7314150105878	1	48
SB6M-20-22	7314150105915	1	48
SB6M-21-23	7314150105922	1	48
SB6M-22-24	7314150105946	1	48
SB6M-24-26	7314150105953	1	48
SB6M-24-27	7314150105960	1	48
SB6M-25-28	7314150189847	1	48
SB6M-27-29	7314150189854	1	48
SB6M-30-32	7314150106011	1	48
SB6M-4-5	7314150106042	1	48
SB6M-6-7	7314150106073	1	48
SB6M-8-9	7314150106103	1	48
SB705.1/4.125	7314150283231	1	216
SB7400SM-10	7314150241101	1	86
SB7400SM-11	7314150241118	1	86
SB7400SM-12	7314150241125	1	86
SB7400SM-13	7314150241132	1	86
SB7400SM-14	7314150241149	1	86
SB7400SM-15	7314150241156	1	86
SB7400SM-16	7314150241170	1	86
SB7400SM-17	7314150241187	1	86
SB7400SM-18	7314150241194	1	86
SB7400SM-19	7314150241200	1	86
SB7400SM-20	7314150241217	1	86
SB7400SM-21	7314150241224	1	86
SB7400SM-22	7314150241231	1	86
SB7400SM-6	7314150241248	1	86
SB7400SM-7	7314150241255	1	86
SB7400SM-8	7314150241262	1	86
SB7400SM-9	7314150241279	1	86
SB7400TORX-E10	7314150241286	1	88
SB7400TORX-E11	7314150241293	1	88
SB7400TORX-E12	7314150241309	1	88
SB7400TORX-E14	7314150241316	1	88
SB7400TORX-E16	7314150241323	1	88
SB7400TORX-E18	7314150241330	1	88
SB7400TORX-E8	7314150241347	1	88
SB7409BH-10	7314150241354	1	91
SB7409BH-4	7314150241361	1	91
SB7409BH-5	7314150241378	1	91
SB7409BH-6	7314150241385	1	91
SB7409BH-8	7314150241392	1	91
SB7409F-10	7314150241408	1	90
SB7409F-6.5	7314150241415	1	90
SB7409F-8	7314150241422	1	90
SB7409M-10	7314150241439	1	91
SB7409M-3	7314150241446	1	91
SB7409M-4	7314150241453	1	91
SB7409M-5	7314150241460	1	91
SB7409M-6	7314150241477	1	91
SB7409M-7	7314150241484	1	91
SB7409M-8	7314150241491	1	91
SB7409PH-1	7314150241507	1	91
SB7409PH-2	7314150241514	1	91
SB7409PH-3	7314150241521	1	91
SB7409TORX-R-T27	7314150241538	1	91
SB7409TORX-R-T30	7314150241545	1	91
SB7409TORX-R-T40	7314150241552	1	91
SB7409TORX-R-T45	7314150241569	1	91
SB7409TORX-R-T50	7314150241576	1	91
SB7409TORX-T20	7314150241583	1	91



SB7409TORX-T25	7314150241590	1	91
SB7409TORX-T25-L	7314150241606	1	91
SB7409TORX-T27	7314150241613	1	91
SB7409TORX-T30	7314150241620	1	91
SB7409TORX-T30-L	7314150241637	1	91
SB7409TORX-T40	7314150241644	1	91
SB7409TORX-T40-L	7314150241651	1	91
SB7409TORX-T45	7314150241668	1	91
SB7409TORX-T45-L	7314150241675	1	91
SB7409TORX-T50	7314150241682	1	91
SB7409TORX-T50-L	7314150241699	1	91
SB7750	7314150187850	1	90
SB7750RN	7314153003966	1	90
SB7754	7314150250165	1	88
SB7755-3/8	7314153010100	1	90
SB7756	7314150489176	1	88
SB7759	7314150254859	1	89
SB7760	7314153003980	1	88
SB7761	7314150241705	1	88
SB7762	7314153004000	1	88
SB7764	7314150241729	1	89
SB7765	7314150241736	1	89
SB7766	7314150241743	1	83
SB7767	7314150254897	1	83
SB7800DM-10	7314150104451	1	93
SB7800DM-11	7314150104468	1	93
SB7800DM-12	7314150104475	1	93
SB7800DM-13	7314150104482	1	93
SB7800DM-14	7314150104499	1	93
SB7800DM-15	7314150104505	1	93
SB7800DM-16	7314150104512	1	93
SB7800DM-17	7314150104529	1	93
SB7800DM-18	7314150104536	1	93
SB7800DM-19	7314150104543	1	93
SB7800DM-20	7314150104550	1	93
SB7800DM-21	7314150104567	1	93
SB7800DM-22	7314150104574	1	93
SB7800DM-23	7314150104581	1	93
SB7800DM-24	7314150104598	1	93
SB7800DM-25	7314150104604	1	93
SB7800DM-26	7314150104611	1	93
SB7800DM-27	7314150104628	1	93
SB7800DM-28	7314150104635	1	93
SB7800DM-29	7314150104642	1	93
SB7800DM-30	7314150104659	1	93
SB7800DM-31	7314150471171	1	93
SB7800DM-32	7314150104666	1	93
SB7800DM-33	7314150240319	1	93
SB7800DM-34	7314150327607	1	93
SB7800DM-36	7314150104673	1	93
SB7800DM-8	7314150104437	1	93
SB7800DM-9	7314150104444	1	93
SB7800DZ-1	7314150234912	1	94
SB7800DZ-1.1/16	7314150240326	1	94
SB7800DZ-1.1/4	7314150240333	1	94
SB7800DZ-1.1/8	7314150240340	1	94
SB7800DZ-1.3/16	7314150240357	1	94
SB7800DZ-1.5/16	7314150240364	1	94
SB7800DZ-1/2	7314150234899	1	94
SB7800DZ-11/16	7314150234929	1	94
SB7800DZ-13/16	7314150234936	1	94
SB7800DZ-15/16	7314150234943	1	94
SB7800DZ-19/32	7314150240371	1	94
SB7800DZ-25/32	7314150240388	1	94
SB7800DZ-3/4	7314150234950	1	94
SB7800DZ-3/8	7314150234967	1	94
SB7800DZ-5/8	7314150234974	1	94
SB7800DZ-7/16	7314150234981	1	94
SB7800DZ-7/8	7314150234998	1	94
SB7800DZ-9/16	7314150235001	1	94
SB7800SM-10	7314150104703	1	93
SB7800SM-11	7314150104710	1	93
SB7800SM-12	7314150104727	1	93
SB7800SM-13	7314150104734	1	93
SB7800SM-14	7314150104741	1	93
SB7800SM-15	7314150104758	1	93
SB7800SM-16	7314150104765	1	93
SB7800SM-17	7314150104772	1	93
SB7800SM-18	7314150104789	1	93
SB7800SM-19	7314150104796	1	93
SB7800SM-20	7314150240395	1	93
SB7800SM-21	7314150104819	1	93
SB7800SM-22	7314150104826	1	93
SB7800SM-23	7314150104833	1	93
SB7800SM-24	7314150104840	1	93
SB7800SM-25	7314150104857	1	93
SB7800SM-26	7314150104864	1	93
SB7800SM-27	7314150104871	1	93
SB7800SM-28	7314150104888	1	93



SB7800SM-29	7314150240401	1	93
SB7800SM-30	7314150104895	1	93
SB7800SM-32	7314150104901	1	93
SB7800SM-33	7314150240418	1	93
SB7800SM-34	7314150235018	1	93
SB7800SM-36	7314150235025	1	93
SB7800SM-8	7314150104680	1	93
SB7800SM-9	7314150104697	1	93
SB7800TORX-E10	7314150240104	1	94
SB7800TORX-E11	7314150240111	1	94
SB7800TORX-E12	7314150240128	1	94
SB7800TORX-E14	7314150240135	1	94
SB7800TORX-E16	7314150240142	1	94
SB7800TORX-E18	7314150240159	1	94
SB7800TORX-E20	7314150240166	1	94
SB7800TORX-E24	7314150240173	1	94
SB7800TORX-E8	7314150240180	1	94
SB7805DM-10	7314150234851	1	94
SB7805DM-12	7314150234868	1	94
SB7805DM-13	7314150235032	1	94
SB7805DM-14	7314150235049	1	94
SB7805DM-15	7314150235056	1	94
SB7805DM-16	7314150235063	1	94
SB7805DM-17	7314150235070	1	94
SB7805DM-18	7314150235087	1	94
SB7805DM-19	7314150235094	1	94
SB7805DM-21	7314150235100	1	94
SB7805DM-22	7314150235117	1	94
SB7805DM-23	7314150327614	1	94
SB7805DM-24	7314150235124	1	94
SB7805DM-26	7314150240197	1	94
SB7805DM-27	7314150235131	1	94
SB7805DM-30	7314150235148	1	94
SB7805DM-32	7314150240203	1	94
SB7805SM-10	7314150235155	1	93
SB7805SM-12	7314150235162	1	93
SB7805SM-13	7314150235179	1	93
SB7805SM-14	7314150235193	1	93
SB7805SM-15	7314150235216	1	93
SB7805SM-16	7314150240210	1	93
SB7805SM-17	7314150235223	1	93
SB7805SM-18	7314150235230	1	93
SB7805SM-19	7314150235247	1	93
SB7805SM-20	7314150240227	1	93
SB7805SM-21	7314150235254	1	93
SB7805SM-22	7314150235261	1	93
SB7805SM-23	7314150240234	1	93
SB7805SM-24	7314150235278	1	93
SB7805SM-25	7314150240241	1	93
SB7805SM-26	7314150240258	1	93
SB7805SM-27	7314150235285	1	93
SB7805SM-28	7314150240265	1	93
SB7805SM-29	7314150240272	1	93
SB7805SM-30	7314150235292	1	93
SB7805SM-32	7314150235308	1	93
SB7805SM-34	7314150498284	1	93
SB7807H	7314150467297	1	177
SB7808H	7314150467303	1	177
SB7809H	7314150467341	1	177
SB7809M-10	7314153004185	1	97
SB7809M-10-140	7314153004192	1	98
SB7809M-12	7314153004208	1	97
SB7809M-14	7314153004215	1	97
SB7809M-17	7314153004222	1	97
SB7809M-19	7314153004239	1	97
SB7809M-4	7314150313952	1	97
SB7809M-5	7314153004109	1	97
SB7809M-5-100	7314150313969	1	98
SB7809M-5-180	7314153004116	1	98
SB7809M-6	7314153004123	1	97
SB7809M-6-100	7314150313976	1	98
SB7809M-6-140	7314153013231	1	98
SB7809M-7	7314153004130	1	97
SB7809M-7-100	7314153004147	1	98
SB7809M-8	7314153004154	1	97
SB7809M-8-120	7314153004161	1	98
SB7809M-9	7314153004178	1	97
SB7809TORX-T20	7314153004017	1	97
SB7809TORX-T25	7314153004024	1	97
SB7809TORX-T27	7314153004031	1	97
SB7809TORX-T30	7314153004048	1	97
SB7809TORX-T40	7314153004055	1	97
SB7809TORX-T45	7314153004062	1	97
SB7809TORX-T50	7314153004079	1	97
SB7809TORX-T55	7314153004086	1	97
SB7809TORX-T60	7314153004093	1	97
SB8150-1/2	7314150105014	1	98
SB8150RN-1/2	7314150105007	1	98
SB8154-11	7314150472178	1	95



SB8157-10	7314150474073	1	95
SB8157-15	7314150472468	1	95
SB8157-24	7314150474080	1	95
SB8157-36	7314150474097	1	95
SB8158-10	7314150488780	1	95
SB8158-15	7314150488797	1	95
SB8160-10	7314150472185	1	95
SB8160-3	7314150472192	1	95
SB8160-5	7314150472208	1	95
SB8166	7314150472154	1	95
SB8171	7314150479016	1	96
SB8172	7314150479023	1	96
SBA6700DM-10	7314150235575	1	81
SBA6700DM-11	7314150241750	1	81
SBA6700DM-12	7314150241767	1	81
SBA6700DM-13	7314150241774	1	81
SBA6700DM-14	7314150241781	1	81
SBA6700DM-5	7314150255054	1	80
SBA6700DM-5.5	7314150241798	1	80
SBA6700DM-6	7314150241804	1	80
SBA6700DM-7	7314150241811	1	80
SBA6700DM-8	7314150241828	1	80
SBA6700DM-9	7314150241835	1	81
SBA6700DZ-1/2	7314150241842	1	81
SBA6700DZ-1/4	7314150241859	1	81
SBA6700DZ-11/32	7314150241866	1	81
SBA6700DZ-3/16	7314150241873	1	81
SBA6700DZ-3/8	7314150241880	1	81
SBA6700DZ-5/16	7314150241897	1	81
SBA6700DZ-7/16	7314150241903	1	81
SBA6700DZ-7/32	7314150241910	1	81
SBA6700DZ-9/16	7314150241927	1	81
SBA6700DZ-9/32	7314150241934	1	81
SBA6709M-2.5	7314150254835	1	85
SBA6709M-3	7314150254828	1	85
SBA6709M-4	7314150254811	1	85
SBA6709M-5	7314150254804	1	85
SBA6709M-6	7314150254798	1	85
SBA6709Z-1/8	7314150254781	1	85
SBA6709Z-3/16	7314150254774	1	85
SBA6709Z-5/32	7314150254767	1	85
SBA6709Z-9/64	7314150254750	1	85
SBA6800DM-10	7314150250172	1	81
SBA6800DM-11	7314150250189	1	81
SBA6800DM-12	7314150250196	1	81
SBA6800DM-13	7314150250202	1	81
SBA6800DM-14	7314150250219	1	81
SBA6800DM-4	7314150250226	1	81
SBA6800DM-5	7314150250233	1	81
SBA6800DM-5.5	7314150250240	1	81
SBA6800DM-6	7314150250257	1	81
SBA6800DM-7	7314150250264	1	81
SBA6800DM-8	7314150250271	1	81
SBA6800DM-9	7314150250288	1	81
SBA6800DZ-1/2	7314150250295	1	81
SBA6800DZ-1/4	7314150250301	1	81
SBA6800DZ-11/32	7314150250318	1	81
SBA6800DZ-3/16	7314150250325	1	81
SBA6800DZ-3/8	7314150250332	1	81
SBA6800DZ-5/16	7314150250349	1	81
SBA6800DZ-7/16	7314150250356	1	81
SBA6800DZ-7/32	7314150250363	1	81
SBA6800DZ-9/16	7314150250370	1	81
SBA6800DZ-9/32	7314150250387	1	81
SBA7400DM-10	7314150241941	1	87
SBA7400DM-11	7314150241958	1	87
SBA7400DM-12	7314150241965	1	87
SBA7400DM-13	7314150241972	1	87
SBA7400DM-14	7314150241989	1	87
SBA7400DM-15	7314150241996	1	87
SBA7400DM-16	7314150242009	1	87
SBA7400DM-17	7314150242016	1	87
SBA7400DM-18	7314150242023	1	87
SBA7400DM-19	7314150242030	1	87
SBA7400DM-20	7314150242047	1	87
SBA7400DM-21	7314150242054	1	87
SBA7400DM-22	7314150242061	1	87
SBA7400DM-6	7314150242078	1	87
SBA7400DM-7	7314150242085	1	87
SBA7400DM-8	7314150242092	1	87
SBA7400DM-9	7314150242108	1	87
SBA7400DZ-1/2	7314150254705	1	87
SBA7400DZ-1/4	7314150242115	1	87
SBA7400DZ-11/16	7314150242122	1	87
SBA7400DZ-13/16	7314150242139	1	87
SBA7400DZ-17/32	7314150242146	1	87
SBA7400DZ-19/32	7314150242153	1	87
SBA7400DZ-3/4	7314150242160	1	87
SBA7400DZ-3/8	7314150242177	1	87



SBA7400DZ-5/16



SBA7400DZ-5/16	7314150242184	1	87
SBA7400DZ-5/8	7314150242191	1	87
SBA7400DZ-7/16	7314150242207	1	87
SBA7400DZ-7/8	7314150242214	1	87
SBA7400DZ-9/16	7314150242221	1	87
SBA7402DM-10	7314150250394	1	87
SBA7402DM-11	7314150250400	1	87
SBA7402DM-12	7314150250417	1	87
SBA7402DM-13	7314150250424	1	87
SBA7402DM-14	7314150250431	1	87
SBA7402DM-15	7314150250448	1	87
SBA7402DM-16	7314150250455	1	87
SBA7402DM-17	7314150250462	1	87
SBA7402DM-18	7314150250479	1	87
SBA7402DM-19	7314150250486	1	87
SBA7402DM-7	7314150250493	1	87
SBA7402DM-8	7314150250509	1	87
SBA7402DM-9	7314150250516	1	87
SBA7402DZ-1/2	7314150250523	1	88
SBA7402DZ-1/4	7314150250530	1	88
SBA7402DZ-11/16	7314150250547	1	88
SBA7402DZ-13/16	7314150250554	1	88
SBA7402DZ-19/32	7314150250561	1	88
SBA7402DZ-3/4	7314150250578	1	88
SBA7402DZ-3/8	7314150250585	1	88
SBA7402DZ-5/16	7314150250592	1	88
SBA7402DZ-5/8	7314150250608	1	88
SBA7402DZ-7/16	7314150250615	1	88
SBA7402DZ-7/8	7314150250622	1	88
SBA7402DZ-9/16	7314150250639	1	88
SBC110-65	7314150456246	1	587
SBE-8135TB	7314150320424	1	198
SBE-8145TB	7314150320431	1	198
SBE-8150TB	7314150320448	1	198
SBE-8155TB	7314150320455	1	198
SBE-8610TB	7314150320493	1	199
SBE-8620TB	7314150320509	1	199
SBE-8810TB	7314150320530	1	199
SBE-8820TB	7314150320547	1	199
SBE-8915TB	7314150320585	1	199
SBE-8920TB	7314150320592	1	199
SBE-8925TB	7314150320608	1	199
SBE-8930TB	7314150320622	1	199
SBE-8940TB	7314150320639	1	199
SBK6701M-10	7314150445233	1	173
SBK6701M-11	7314150445240	1	173
SBK6701M-12	7314150445264	1	173
SBK6701M-13	7314150445271	1	173
SBK6701M-14	7314150445288	1	173
SBK6701M-6	7314150445196	1	172
SBK6701M-7	7314150445202	1	172
SBK6701M-8	7314150445219	1	172
SBK6701M-9	7314150445226	1	173
SBK7401M-10	7314150445325	1	173
SBK7401M-11	7314150445332	1	173
SBK7401M-12	7314150445349	1	173
SBK7401M-13	7314150445356	1	173
SBK7401M-14	7314150445363	1	173
SBK7401M-15	7314150445370	1	173
SBK7401M-16	7314150445387	1	173
SBK7401M-17	7314150445394	1	173
SBK7401M-18	7314150445400	1	173
SBK7401M-19	7314150445417	1	173
SBK7401M-20	7314150445424	1	173
SBK7401M-21	7314150445431	1	173
SBK7401M-22	7314150445448	1	173
SBK7401M-24	7314150445455	1	173
SBK7401M-7	7314150445295	1	173
SBK7401M-8	7314150445301	1	173
SBK7401M-9	7314150445318	1	173
SBK7764D	7314150447800	1	177
SBK7801M-10	7314150445486	1	175
SBK7801M-11	7314150445493	1	175
SBK7801M-12	7314150445509	1	175
SBK7801M-13	7314150445516	1	175
SBK7801M-14	7314150445523	1	175
SBK7801M-15	7314150445530	1	175
SBK7801M-16	7314150445547	1	175
SBK7801M-17	7314150445554	1	175
SBK7801M-18	7314150445561	1	175
SBK7801M-19	7314150445578	1	175
SBK7801M-20	7314150445585	1	175
SBK7801M-21	7314150445592	1	175
SBK7801M-22	7314150445608	1	175
SBK7801M-23	7314150445615	1	175
SBK7801M-24	7314150445622	1	175
SBK7801M-25	7314150445639	1	175
SBK7801M-26	7314150445646	1	175
SBK7801M-27	7314150445653	1	175



SBK7801M-28	7314150450763	1	175
SBK7801M-29	7314150450770	1	175
SBK7801M-30	7314150445660	1	175
SBK7801M-32	7314150445677	1	175
SBK7801M-34	7314150445684	1	175
SBK7801M-36	7314150445691	1	175
SBK7801M-8	7314150445462	1	175
SBK7801M-9	7314150445479	1	175
SBK7801Z-1	7314150448036	1	176
SBK7801Z-1.1/16	7314150448142	1	176
SBK7801Z-1.1/2	7314150448203	1	176
SBK7801Z-1.1/4	7314150448166	1	176
SBK7801Z-1.1/8	7314150448159	1	176
SBK7801Z-1.3/8	7314150448180	1	176
SBK7801Z-1.5/16	7314150448173	1	176
SBK7801Z-1.7/16	7314150448197	1	176
SBK7801Z-1/2	7314150448067	1	176
SBK7801Z-11/16	7314150448098	1	176
SBK7801Z-13/16	7314150448111	1	176
SBK7801Z-15/16	7314150448135	1	176
SBK7801Z-3/4	7314150448104	1	176
SBK7801Z-3/8	7314150448043	1	176
SBK7801Z-5/8	7314150448081	1	176
SBK7801Z-7/16	7314150448050	1	176
SBK7801Z-7/8	7314150448128	1	176
SBK7801Z-9/16	7314150448074	1	176
SBK7806M-10	7314150447831	1	176
SBK7806M-11	7314150447862	1	176
SBK7806M-12	7314150447879	1	176
SBK7806M-13	7314150447886	1	176
SBK7806M-14	7314150447893	1	176
SBK7806M-15	7314150447909	1	176
SBK7806M-16	7314150447916	1	176
SBK7806M-17	7314150447923	1	176
SBK7806M-18	7314150447930	1	176
SBK7806M-19	7314150447947	1	176
SBK7806M-21	7314150447954	1	176
SBK7806M-22	7314150447961	1	176
SBK7806M-23	7314150447978	1	176
SBK7806M-24	7314150447985	1	176
SBK7806M-27	7314150447992	1	176
SBK7806M-30	7314150448005	1	176
SBK7806M-32	7314150448012	1	176
SBK7806M-36	7314150448029	1	176
SBK7806Z-1	7314150448401	1	176
SBK7806Z-1.1/16	7314150448418	1	176
SBK7806Z-1.1/2	7314150448470	1	176
SBK7806Z-1.1/4	7314150448432	1	176
SBK7806Z-1.1/8	7314150448425	5	176
SBK7806Z-1.3/8	7314150448456	5	176
SBK7806Z-1.5/16	7314150448449	1	176
SBK7806Z-1.7/16	7314150448463	5	176
SBK7806Z-1/2	7314150448326	10	176
SBK7806Z-11/16	7314150448357	1	176
SBK7806Z-13/16	7314150448371	1	176
SBK7806Z-15/16	7314150448395	1	176
SBK7806Z-3/4	7314150448364	1	176
SBK7806Z-3/8	7314150448302	10	176
SBK7806Z-5/8	7314150448340	5	176
SBK7806Z-7/16	7314150448319	10	176
SBK7806Z-7/8	7314150448388	1	176
SBK7806Z-9/16	7314150448333	10	176
SBK8160D-1	7314150447770	1	177
SBK8160D-2	7314150447787	1	177
SBK8160D-3	7314150447794	1	177
SBK8901M-17	7314150448487	1	179
SBK8901M-18	7314150448494	1	179
SBK8901M-19	7314150448500	1	179
SBK8901M-21	7314150448517	1	179
SBK8901M-22	7314150448524	1	179
SBK8901M-23	7314150448531	1	179
SBK8901M-24	7314150448548	1	179
SBK8901M-27	7314150448555	1	179
SBK8901M-28	7314150448562	1	179
SBK8901M-29	7314150448579	1	179
SBK8901M-30	7314150448586	1	179
SBK8901M-32	7314150448593	1	179
SBK8901M-33	7314150448609	1	179
SBK8901M-34	7314150448616	1	179
SBK8901M-36	7314150448623	1	179
SBK8901M-38	7314150448630	1	179
SBK8901M-41	7314150448647	1	179
SBK8901M-46	7314150448654	1	179
SBK8901M-50	7314150448661	1	179
SBK8901M-55	7314150448678	1	179
SBK8901M-60	7314150448685	1	179
SBK8964D	7314150447817	1	179
SBS19-TH10	7314150190072	1	92
SBS19-TH11	7314150190089	1	92

SBS19-TH12	7314150190096	1	92
SBS19-TH13	7314150190102	1	92
SBS19-TH14	7314150190119	1	92
SBS19-TH15	7314150190126	1	92
SBS19-TH16	7314150190133	1	92
SBS19-TH17	7314150190140	1	92
SBS19-TH18	7314150190157	1	92
SBS19-TH19	7314150190164	1	92
SBS19-TH21	7314150190256	1	92
SBS19-TH22	7314150190188	1	92
SBS19-TH24	7314150190195	1	92
SBS20-11	7314153009159	1	41
SBS20-12	7314153009166	1	41
SBS20-13	7314153009173	1	41
SBS20-14	7314153009180	1	41
SBS20-15	7314153009197	1	41
SBS20-16	7314153009203	1	41
SBS20-20	7314153009241	1	41
SBS20-22	7314153009265	1	41
SBS20-24	7314153009272	1	41
SBS20-7	7314153009111	1	41
SBS20-8	7314153009128	1	41
SBS20-9	7314153009135	1	41
SBS61	7314153009661	1	85
SBS61S	7314150179886	1	85
SBS705	7314153012968	1	88
SBS750	7314153012883	10	90
SBS780	7314150125197	1	89
SBS81	7314153009937	5	99
SBSL25	7314153015853	5	64
SC127	7314150121984	10	593
SC127S	7314150121991	10	593
SC127V	7314150121847	5	513
SC140	7314150122004	10	593
SC140C	7314150122011	10	593
SC150NG	7314150122028	10	593
SC150NGV	7314150121854	5	513
SC2RM-13-17	7314150265350	10	104
SC2RM-15-17	7314150265367	10	104
SC2RM-19-22	7314150181384	10	104
SC2RM-27-30	7314150265343	1	104
SC335M-17	7314150344314	1	51
SC335M-19	7314150344321	1	51
SC335M-22	7314150344338	1	51
SC335M-24	7314150344345	1	51
SC335M-27	7314150344352	1	51
SC335M-30	7314150344369	1	51
SC335M-32	7314150344376	1	51
SC335M-36	7314150344383	1	51
SC335M-41	7314150344390	1	51
SC335M-46	7314150344406	1	51
SCB140	7314150297351	10	593
SCB140G	7314150297368	10	593
SCRAPER-SET2	7311518228613	1	562
SE-15-24	7311518029838	5	647
SE-15-30	7311518029821	5	647
SE-15-30-23	7311518029845	5	647
SE-15-32	7311518249168	5	647
SE-15-36	7311518141202	5	647
SE-15-36-23	7311518258276	5	647
SE-16-21	7311518029807	5	647
SE-16-21-23	7311518273934	5	647
SH-407	7314150389827	1	610
SH-427-700	7314150349074	10	610
SH-428-700	7314150349081	10	610
SH-485W	7314150358021	1	608
SH-485W-PLATES	7314150358038	1	608
SH-486-493-495	7314150349098	10	610
SH-486F493F495F	7314150349104	10	610
SH-486W	7314150358014	1	609
SH-488-2000	7314150346912	10	610
SH-488-34	7314150349036	10	610
SH-488-56	7314150349043	10	610
SH-488F-2000	7314150346950	10	610
SH-488F-34	7314150349050	1	610
SH-488F-56	7314150349067	1	610
SH-491-34	7314150374298	12	610
SH-491-56	7314150374304	12	610
SH-FCP-860	7311518324421	1	615
SH-FCS-810	7311518140540	1	615
SH-FCS-860	7311518140557	1	615
SH-FGS-1.8-810	7311518327828	1	615
SH-FGS-600	7311518140649	1	615
SH-FGS-700	7311518140656	12	615
SH-FGS-800	7311518140663	1	615
SH-HFGPS-400FG	7311518282301	1	615
SH-HGPS-360	7311518140618	12	615
SH-HGPS-380	7311518140625	1	615
SH-HGPS-400	7311518207618	1	615

SH-HUS-380	7311518140502	1	615
SH-HUS-500	7311518140519	1	615
SH-HUS-650	7311518140526	1	615
SH-MCS-800	7311518140595	1	615
SH-MES-900	7311518140601	12	615
SH-MES-900FG	7311518282318	12	615
SH-MES-F-900	7311518141554	12	615
SH-PAGS-900	7311518327866	1	615
SH-PAGS-900FG	7311518326944	1	615
SH-SUS-800	7311518140809	12	615
SHARP-INS	7314150197897	100	580
SHARP-X	7311518264895	10	651
SHARP-X-DISP	7311518264901	1	651
SL24	7314150128389	1	64
SL25	7314153013422	24	64
SL25AF	7314150180141	1	64
SL25L	7314150256570	10	64
SL34	7314150409181	6	70
SL65	7314150444137	6	64
SL79	7314150444144	4	63
SL91	7314150444151	4	63
SLX 17	7314153015785	1	78
SLX 17AF	7314150137558	1	78
SLX17-CASE	7314150321254	1	104
SP120	7314150312474	1	96
SP120XL	7314150313594	1	96
SPAR-CASE-A4	7314150263523	1	104
SPAR-CASE-A6	7314150263547	1	104
SPAR-CASE-A7	7314150263554	1	104
SQZ-MINI	7314150186280	24	596
SQZ-MINI-BLADE	7314150190348	1	597
SQZ150003	7314153013477	6	594
SQZ150003-HSBL	7314153015389	6	595
SQZ150003-SBL	7314153015372	1	595
SR1000-E	7314150302918	20	558
SR1000-MM	7314150302857	20	557
SR150-E	7314150302864	12	558
SR150-MM	7314150302819	12	557
SR200-E	7314150302871	12	558
SR200-MM	7314150302826	12	557
SR300-E	7314150302888	12	558
SR300-MM	7314150302833	12	557
SR600-E	7314150302901	20	558
SR600-MM	7314150302840	20	557
SS001-100	7314150404384	1	538
SS001-150	7314150404377	1	538
SS001-200	7314150404391	1	538
SS001-250	7314150404407	1	538
SS001-300	7314150404414	1	538
SS001-375	7314150404421	1	538
SS001-450	7314150404438	1	538
SS001-600	7314150404445	1	538
SS002-10	7314150404483	1	538
SS002-11	7314150404490	1	538
SS002-12	7314150404506	1	538
SS002-13	7314150404513	1	538
SS002-14	7314150404520	1	538
SS002-15	7314150404537	1	538
SS002-16	7314150404551	1	538
SS002-17	7314150404568	1	538
SS002-19	7314150404575	1	538
SS002-21	7314150404582	1	538
SS002-22	7314150404599	1	538
SS002-24	7314150404605	1	538
SS002-27	7314150404612	1	538
SS002-32	7314150404629	1	538
SS002-6	7314150404469	1	538
SS002-6-2	7314150407903	1	538
SS002-8	7314150404476	1	538
SS002-9-2	7314150407910	1	538
SS003-10	7314150404643	1	538
SS003-11	7314150404650	1	538
SS003-12	7314150404667	1	538
SS003-14	7314150404681	1	538
SS003-16	7314150404704	1	538
SS003-18	7314150404711	1	538
SS003-20	7314150404728	1	538
SS003-22	7314150404735	1	538
SS003-24	7314150404742	1	538
SS003-25	7314150404759	1	538
SS003-26	7314150404766	1	538
SS003-28	7314150404773	1	538
SS003-30	7314150404780	1	538
SS003-8	7314150404636	1	538
SS011-0507	7314150404797	1	538
SS011-0607	7314150404803	1	538
SS011-0809	7314150404810	1	538
SS011-0810	7314150404827	1	538
SS011-0911	7314150404834	1	538





SS011-1012	7314150404858	1	538
SS011-11-3	7314150419142	1	539
SS011-1214	7314150404865	1	538
SS011-1417	7314150404872	1	538
SS011-1618	7314150404889	1	538
SS011-1719	7314150404896	1	538
SS011-1722	7314150404902	1	538
SS011-2224	7314150404919	1	538
SS011-2427	7314150404926	1	538
SS011-2430	7314150404940	1	538
SS011-3032	7314150404957	1	538
SS011-9-3	7314150419135	1	539
SS210-10	7314150405343	1	539
SS210-11	7314150405350	1	539
SS210-12	7314150405367	1	539
SS210-13	7314150405374	1	539
SS210-14	7314150405381	1	539
SS210-4	7314150405268	1	539
SS210-4.5	7314150405275	1	539
SS210-5	7314150405282	1	539
SS210-5.5	7314150405299	1	539
SS210-6	7314150405305	1	539
SS210-7	7314150405312	1	539
SS210-8	7314150405329	1	539
SS210-9	7314150405336	1	539
SS220-10	7314150404995	1	539
SS220-11	7314150405008	1	539
SS220-12	7314150405022	1	539
SS220-13	7314150405039	1	539
SS220-14	7314150405053	1	539
SS220-15	7314150405060	1	539
SS220-16	7314150405077	1	539
SS220-17	7314150405084	1	539
SS220-18	7314150405091	1	539
SS220-19	7314150405114	1	539
SS220-20	7314150405121	1	539
SS220-21	7314150405138	1	539
SS220-22	7314150405145	1	539
SS220-23	7314150405152	1	539
SS220-24	7314150405176	1	539
SS220-25	7314150405183	1	539
SS220-26	7314150405190	1	539
SS220-27	7314150405206	1	539
SS220-28	7314150405213	1	539
SS220-29	7314150405220	1	539
SS220-30	7314150405237	1	539
SS220-31	7314150405244	1	539
SS220-32	7314150405251	1	539
SS220-8	7314150404964	1	539
SS220-9	7314150404988	1	539
SS224-17	7314150405398	1	539
SS224-19	7314150405404	1	539
SS224-22	7314150405411	1	539
SS224-24	7314150405428	1	539
SS224-27	7314150405435	1	539
SS224-30	7314150405442	1	539
SS224-32	7314150405459	1	539
SS224-34	7314150405466	1	539
SS224-36	7314150405473	1	539
SS224-41	7314150405480	1	539
SS224-46	7314150405497	1	539
SS224-50	7314150405503	1	539
SS224-55	7314150405510	1	539
SS224-60	7314150405527	1	539
SS224-65	7314150405534	1	539
SS234-16-100	7314150405572	1	539
SS234-16-200	7314150405589	1	539
SS234-16-250	7314150405602	1	539
SS234-24-100	7314150405619	1	539
SS234-24-200	7314150405626	1	539
SS234-24-250	7314150405633	1	539
SS236-08-80	7314150405718	1	539
SS236-16-80	7314150405701	1	539
SS236-24-110	7314150405725	1	539
SS238-08-250	7314150405657	1	540
SS238-16-250	7314150405640	1	540
SS238-24-350	7314150405664	1	540
SS242-08-200	7314150405558	1	540
SS242-16-245	7314150405541	1	540
SS242-24-320	7314150405565	1	540
SS243-08	7314150405688	1	540
SS243-16	7314150405671	1	540
SS243-24	7314150405695	1	540
SS324-1.5	7314150405732	2	541
SS324-10	7314150405824	1	541
SS324-2	7314150405749	2	541
SS324-2.5	7314150405756	2	541
SS324-3	7314150405763	1	541
SS324-4	7314150405770	1	541



SS324-5	7314150405787	1	541
SS324-6	7314150405794	1	541
SS324-8	7314150405817	1	541
SS325-10	7314150405886	1	541
SS325-12	7314150405879	1	541
SS325-2.5	7314150405909	2	541
SS325-3	7314150405862	2	541
SS325-3.5	7314150405923	2	541
SS325-4	7314150405848	1	541
SS325-4.5	7314150405930	1	541
SS325-5	7314150405893	1	541
SS325-6	7314150405855	1	541
SS325-7	7314150405916	1	541
SS325-8	7314150405831	1	541
SS400-160	7314150405978	1	542
SS400-180	7314150405985	1	542
SS400-200	7314150405992	1	542
SS402-160	7314150406005	1	542
SS402-200	7314150406012	1	542
SS406-160	7314150406029	1	542
SS406-200	7314150406036	1	542
SS410-250	7314150406043	1	542
SS410-300	7314150406050	1	542
SS412-200	7314150406067	1	542
SS415-225	7314150406074	1	542
SS502-1000-FB	7314150406081	1	542
SS502-1500-FB	7314150406098	1	542
SS502-2000-FB	7314150406104	1	542
SS502-2500-FB	7314150406111	1	542
SS502-3000-FB	7314150406128	1	542
SS502-3600-FB	7314150406135	1	542
SS506-1100-FB	7314150406197	1	542
SS506-200-FB	7314150406142	1	542
SS506-300-FB	7314150406159	1	542
SS506-500-FB	7314150406166	1	542
SS506-700-FB	7314150406173	1	542
SS506-900-FB	7314150406180	1	542
SS603-15-500	7314150406203	1	542
SS603-19-500	7314150406210	1	542
SS603-20-500	7314150406227	1	542
SS603-23-500	7314150406234	1	542
SS603-23-800	7314150406258	1	542
SS603-25-600	7314150406241	1	542
SS603-30-1000	7314150406265	1	542
SS610-16-160	7314150406272	1	542
SS610-18-200	7314150406289	1	542
SS610-24-300	7314150406296	1	542
SS610-25-400	7314150406302	1	542
SS610-30-500	7314150406319	1	542
SUC-0.7-450	7314150342082	4	615
SUC-0.9-600	7314150342105	4	615
SUC-1.0-710	7314150342068	4	615
SUC-1.7-800	7314150342051	4	615
SUP-20-LAM	7311518258351	4	577
SUS-2.0-800	7311518123451	4	614
SW65	7314150442898	6	64
SW79	7314150442904	4	63
SW91	7314150442942	4	63
TAH08-10	7314150305087	1	485
TAH08-11	7314150305094	1	485
TAH08-12	7314150305100	1	485
TAH08-13	7314150305117	1	485
TAH08-5.5	7314150305032	1	485
TAH08-6	7314150305049	1	485
TAH08-7	7314150305056	1	485
TAH08-8	7314150305063	1	485
TAH08-9	7314150305070	1	485
TAH08-H3	7314150305124	1	486
TAH08-H4	7314150305131	1	486
TAH08-H5	7314150305148	1	486
TAH08-H6	7314150305155	1	486
TAH08-H8	7314150305162	1	486
TAH08-PH1	7314150305179	1	486
TAH08-PH2	7314150305186	1	486
TAH08-PH3	7314150305193	1	486
TAH08-T10	7314150305223	1	486
TAH08-T15	7314150305230	1	486
TAH08-T20	7314150305247	1	486
TAH08-T25	7314150305254	1	486
TAH08-T27	7314150305261	1	486
TAH08-T30	7314150305278	1	486
TAH08-T40	7314150305285	1	486
TAH08-T8	7314150305209	1	486
TAH08-T9	7314150305216	1	486
TAH1-100-06-2-4	7314150307531	1	493
TAH1-110-08-1-2	7314150437825	1	493
TAH1-143-12-1-2	7314150307548	1	493
TAH1-160-08-1-2	7314150437818	1	494
TAH1-170-08-1-2	7314150437801	1	494



TAH1-210-06-2-2	7314150307555	1	494
TAH1-210-08-1-2	7314150437795	1	494
TAH1-230-06-2-2	7314150307562	1	494
TAH1-230-08-1-2	7314150437788	1	494
TAH111M-10	7314150308538	1	483
TAH111M-11	7314150308545	1	483
TAH111M-12	7314150308552	1	483
TAH111M-13	7314150308569	1	483
TAH111M-14	7314150308576	1	483
TAH111M-15	7314150308583	1	483
TAH111M-16	7314150308590	1	483
TAH111M-17	7314150308606	1	483
TAH111M-18	7314150308613	1	483
TAH111M-19	7314150308620	1	483
TAH111M-20	7314150308637	1	483
TAH111M-21	7314150308644	1	483
TAH111M-22	7314150308651	1	483
TAH111M-23	7314150308668	1	483
TAH111M-24	7314150308675	1	483
TAH111M-25	7314150308682	1	483
TAH111M-27	7314150308699	1	483
TAH111M-30	7314150308706	1	483
TAH111M-32	7314150308712	1	483
TAH111M-34	7314150308729	1	483
TAH111M-36	7314150308736	1	483
TAH111M-41	7314150308743	1	483
TAH111M-46	7314150308750	1	483
TAH111M-50	7314150411573	1	483
TAH111M-55	7314150308491	1	483
TAH111M-6	7314150308507	1	483
TAH111M-7	7314150308514	1	483
TAH111M-8	7314150362356	1	483
TAH111M-85	7314150308521	1	483
TAH111M-9	7314150343362	1	484
TAH111Z-1	7314150343379	1	484
TAH111Z-1.1/16	7314150431830	1	484
TAH111Z-1.1/2	7314150343386	1	484
TAH111Z-1.1/4	7314150343393	1	484
TAH111Z-1.1/8	7314150431854	1	484
TAH111Z-1.11/16	7314150431878	1	484
TAH111Z-1.13/16	7314150431861	1	484
TAH111Z-1.3/4	7314150431816	1	484
TAH111Z-1.3/8	7314150343409	1	484
TAH111Z-1.5/16	7314150431847	1	484
TAH111Z-1.5/8	7314150431823	1	484
TAH111Z-1.7/16	7314150431885	1	484
TAH111Z-1.7/8	7314150343461	1	484
TAH111Z-1/2	7314150343508	1	484
TAH111Z-1/4	7314150343522	1	484
TAH111Z-11/16	7314150343539	1	484
TAH111Z-13/16	7314150343546	1	484
TAH111Z-15/16	7314150431892	1	484
TAH111Z-2	7314150431915	1	484
TAH111Z-2.1/2	7314150431908	1	484
TAH111Z-2.1/4	7314150431946	1	484
TAH111Z-2.1/8	7314150413959	1	484
TAH111Z-2.3/4	7314150431939	1	484
TAH111Z-2.3/8	7314150431953	1	484
TAH111Z-2.5/8	7314150431960	1	484
TAH111Z-2.7/8	7314150343553	1	484
TAH111Z-3	7314150343560	1	484
TAH111Z-3/4	7314150343591	1	484
TAH111Z-3/8	7314150343607	1	484
TAH111Z-5/16	7314150343614	1	484
TAH111Z-5/8	7314150343621	1	484
TAH111Z-7/16	7314150343638	1	484
TAH111Z-7/8	7314150307760	1	497
TAH1150-1/2H/P	7314150307777	1	497
TAH1177-SCRIBER	7314150344475	1	485
TAH140	7314150339433	1	485
TAH141	7314150344543	1	485
TAH1410	7314150339440	1	485
TAH142	7314150344550	1	485
TAH143	7314150344482	1	485
TAH1544	7314150307746	1	497
TAH16-H10	7314150306176	1	487
TAH16-H12	7314150306183	1	487
TAH16-H14	7314150306190	1	487
TAH16-H17	7314150306206	1	487
TAH16-H19	7314150306213	1	487
TAH16-H4	7314150306121	1	487
TAH16-H5	7314150306138	1	487
TAH16-H6	7314150306145	1	487
TAH16-H7	7314150306152	1	487
TAH16-H8	7314150306169	1	487
TAH16-T30	7314150306220	1	487
TAH16-T40	7314150306237	1	487



TAH16-T45	7314150306244	1	487
TAH16-T50	7314150306251	1	487
TAH16-T55	7314150306268	1	487
TAH16-T60	7314150306275	1	487
TAH16B-1	7314150306077	1	487
TAH16B-1.1/16	7314150306084	1	487
TAH16B-1.1/4	7314150306107	1	487
TAH16B-1.1/8	7314150306114	1	487
TAH16B-1/2	7314150305995	1	486
TAH16B-10	7314150305629	1	486
TAH16B-11	7314150305636	1	486
TAH16B-11/16	7314150306022	1	487
TAH16B-12	7314150305643	1	486
TAH16B-13	7314150305650	1	486
TAH16B-13/16	7314150306046	1	487
TAH16B-14	7314150305667	1	486
TAH16B-15	7314150305674	1	486
TAH16B-15/16	7314150306060	1	487
TAH16B-16	7314150305698	1	486
TAH16B-17	7314150305704	1	486
TAH16B-18	7314150305711	1	486
TAH16B-19	7314150305728	1	486
TAH16B-21	7314150305735	1	486
TAH16B-22	7314150305742	1	486
TAH16B-24	7314150305759	1	486
TAH16B-25	7314150305766	1	486
TAH16B-27	7314150305773	1	486
TAH16B-3/4	7314150306039	1	487
TAH16B-30	7314150305780	1	486
TAH16B-32	7314150305797	1	486
TAH16B-5/8	7314150306015	1	487
TAH16B-7/8	7314150306053	1	487
TAH16B-8	7314150305612	1	486
TAH16B-9/16	7314150306008	1	486
TAH16BM/22	7314150422357	1	488
TAH16BZ/17	7314150422340	1	488
TAH16H-1/2	7314150306329	1	487
TAH16H-1/4	7314150306282	1	487
TAH16H-3/8	7314150306305	1	487
TAH16H-5/16	7314150306299	1	487
TAH16H-5/8	7314150306343	1	487
TAH16H-7/16	7314150306312	1	487
TAH16H-9/16	7314150306336	1	487
TAH1949M-10-11	7314150308866	1	484
TAH1949M-12-14	7314150308873	1	484
TAH1949M-14-17	7314150308880	1	484
TAH1949M-19-22	7314150308897	1	484
TAH1949M-24-27	7314150308903	1	484
TAH1949M-8-9	7314150308859	1	484
TAH1995M-10	7314150432219	1	490
TAH1995M-12	7314150432226	1	490
TAH1995M-8	7314150432202	1	490
TAH1995Z-1/2	7314150415007	1	490
TAH1RM-10	7314150414338	1	484
TAH1RM-11	7314150424306	1	484
TAH1RM-12	7314150424313	1	484
TAH1RM-13	7314150414345	1	484
TAH1RM-14	7314150424320	1	484
TAH1RM-15	7314150424337	1	484
TAH1RM-16	7314150414352	1	484
TAH1RM-17	7314150352210	1	484
TAH1RM-18	7314150414369	1	484
TAH1RM-19	7314150352227	1	484
TAH1RM-21	7314150424344	1	484
TAH1RM-22	7314150424351	1	484
TAH1RM-24	7314150352234	1	484
TAH1RM-27	7314150424368	1	484
TAH1RM-30	7314150352241	1	484
TAH1RM-32	7314150424375	1	484
TAH1RM-6	7314150424269	1	484
TAH1RM-7	7314150424276	1	484
TAH1RM-8	7314150424283	1	484
TAH1RM-9	7314150424290	1	484
TAH2047-0.8-4	7314150308088	1	491
TAH2047PR-1-2	7314150308095	1	491
TAH2101G-125	7314150344581	1	491
TAH2101G-125C	7314150344598	1	491
TAH2101G-140	7314150307869	1	491
TAH2101G-140C	7314150344611	1	491
TAH2101G-160	7314150307876	1	491
TAH2101G-160C	7314150344635	1	491
TAH2101G-180	7314150345106	1	491
TAH2101G-180C	7314150344666	1	491
TAH21HDG-200	7314150345649	1	491
TAH21HDG-200C	7314150345656	1	491
TAH2223G-150	7314150411597	1	492
TAH225-PLUS	7314150319978	1	493
TAH2427G-200	7314150307883	1	492
TAH2430G-160	7314150413942	1	491



TAH2430G-200



TAH2430G-200	7314150307906	1	491
TAH2484-30	7314150307968	1	496
TAH2487	7314150320028	1	498
TAH24B-27	7314150309306	1	488
TAH24B-30	7314150309313	1	488
TAH24B-32	7314150309320	1	488
TAH24B-36	7314150309337	1	488
TAH24B-38	7314150309344	1	488
TAH24B-41	7314150309351	1	488
TAH24B-46	7314150309368	1	488
TAH24B-50	7314150309375	1	488
TAH2509	7314150307753	1	498
TAH2535F2	7314150307784	1	498
TAH2628G-160	7314150307913	1	491
TAH2628G-180	7314150307920	1	491
TAH2628G-200	7314150432363	1	491
TAH2633/S4	7314150415014	1	498
TAH2800-150	7314150519330	1	492
TAH2800-180	7314150424559	1	492
TAH2820EF2	7314150307708	1	494
TAH2855	7314150307937	1	493
TAH2900-180	7314150424566	1	492
TAH2951-250	7314150432400	1	492
TAH2953-140	7314150415731	1	492
TAH2953-300	7314150415748	1	492
TAH2958-200	7314150320219	1	492
TAH2958-250	7314150307944	1	492
TAH2970G-200	7314150343331	1	491
TAH29M-10	7314150414413	1	485
TAH29M-11	7314150414420	1	485
TAH29M-12	7314150424382	1	485
TAH29M-13	7314150414437	1	485
TAH29M-14	7314150424399	1	485
TAH29M-15	7314150424405	1	485
TAH29M-16	7314150424412	1	485
TAH29M-17	7314150414444	1	485
TAH29M-18	7314150424429	1	485
TAH29M-19	7314150424436	1	485
TAH29M-20	7314150424443	1	485
TAH29M-21	7314150414451	1	485
TAH29M-22	7314150424450	1	485
TAH29M-23	7314150424467	1	485
TAH29M-24	7314150424474	1	485
TAH29M-25	7314150424481	1	485
TAH29M-26	7314150424498	1	485
TAH29M-27	7314150424504	1	485
TAH29M-28	7314150424511	1	485
TAH29M-29	7314150424528	1	485
TAH29M-30	7314150424535	1	485
TAH29M-32	7314150424542	1	485
TAH29M-6	7314150414376	1	485
TAH29M-7	7314150414383	1	485
TAH29M-8	7314150414390	1	485
TAH29M-9	7314150414406	1	485
TAH2M-10-11	7314150427772	1	484
TAH2M-12-13	7314150427789	1	484
TAH2M-14-15	7314150427796	1	484
TAH2M-16-17	7314150427802	1	484
TAH2M-18-19	7314150427819	1	484
TAH2M-6-7	7314150427758	1	484
TAH2M-8-9	7314150427765	1	484
TAH317	7314150319985	1	493
TAH320	7314150319992	1	493
TAH325	7314150320004	1	493
TAH3625PU-50	7314150307579	1	494
TAH3625W-35	7314150307609	1	495
TAH3640-250-C	7314150307975	1	496
TAH3681-11	7314150415038	1	496
TAH3681-16	7314150415045	1	496
TAH3681-20	7314150415052	1	496
TAH3683	7314150352258	1	496
TAH3734BM-10	7314150308057	1	496
TAH3734BM-2	7314150343348	1	496
TAH3734BM-3	7314150307982	1	496
TAH3734BM-4	7314150308019	1	496
TAH3734BM-5	7314150308026	1	496
TAH3734BM-6	7314150308033	1	496
TAH3734BM-8	7314150308040	1	496
TAH3739-300	7314150373925	1	496
TAH3755BM-4	7314150308064	1	496
TAH380-10	7314150307845	1	485
TAH380-14	7314150320172	1	485
TAH380-18	7314150307852	1	485
TAH380-24	7314150343317	1	485
TAH396-JT	7314150373932	1	493
TAH420SH-80-160	7314150411610	1	498
TAH466-250	7314150307791	1	497
TAH479-16	7314150307586	1	495
TAH479-32	7314150307593	1	495



TAH481-300	7314150307616	1	495
TAH484-1000	7314150373918	1	495
TAH484-1500	7314150307623	1	495
TAH484-2000	7314150319916	1	495
TAH485	7314150459902	1	495
TAH486F-700	7314150370658	1	495
TAH487-5200	7314150307630	1	495
TAH489-1100	7314150307647	1	495
TAH489-1800	7314150343294	1	495
TAH489-2700	7314150319923	1	495
TAH489-3600	7314150307654	1	495
TAH489-4500	7314150427567	1	495
TAH489-5400	7314150319930	1	495
TAH489-6300	7314150427581	1	495
TAH490-1100	7314150427475	1	495
TAH490-700	7314150427529	1	495
TAH490-900	7314150427536	1	495
TAH52	7314150339730	1	494
TAH6950	7314150309054	1	486
TAH6956-1	7314150309061	1	486
TAH6958B-1	7314150309078	1	485
TAH6960	7314150305315	1	486
TAH6961	7314150305322	1	486
TAH6962	7314150305339	1	486
TAH6962L	7314150305346	1	486
TAH6966	7314150305353	1	486
TAH6M-10-11	7314150370665	1	484
TAH6M-12-13	7314150370672	1	484
TAH6M-14-15	7314150400393	1	484
TAH6M-16-17	7314150400409	1	484
TAH6M-17-19	7314150370689	1	484
TAH6M-18-19	7314150400416	1	484
TAH6M-20-22	7314150400423	1	484
TAH6M-24-27	7314150400430	1	484
TAH6M-30-32	7314150400447	1	484
TAH6M-6-7	7314150427741	1	484
TAH6M-8-9	7314150400386	1	484
TAH700-1.5-50	7314150432301	1	490
TAH700-1.8-50	7314150432318	1	490
TAH700-2.5-50	7314150432325	1	490
TAH700-3-100	7314150432332	1	490
TAH701-0-50	7314150432349	1	490
TAH701-00-50	7314150432356	1	490
TAH703-10-50	7314150432288	1	490
TAH703-15-75	7314150432295	1	490
TAH703-6-50	7314150432240	1	490
TAH703-7-50	7314150432257	1	490
TAH703-8-50	7314150432264	1	490
TAH703-9-50	7314150432271	1	490
TAH73R-100	7314150503810	1	497
TAH73R-200	7314150503834	1	497
TAH73R-300	7314150503858	1	497
TAH7444SG-M-36	7314150308934	1	484
TAH7444SG-M-41	7314150308941	1	484
TAH7444SG-M-46	7314150308958	1	484
TAH7444SG-M-50	7314150308965	1	484
TAH7444SG-M-55	7314150308972	1	484
TAH7445-100A-1	7314150327546	1	497
TAH7452-2	7314150302543	1	498
TAH7455-300-1	7314150309412	1	498
TAH74W9-100	7314150519354	1	498
TAH782-U	7314150339747	1	494
TAH7852-1	7314150302550	1	498
TAH8069	7314150383603	1	483
TAH8069C	7314150383610	1	483
TAH8070	7314150347025	1	483
TAH8070C	7314150383627	1	483
TAH8071	7314150347032	1	483
TAH8071C	7314150383634	1	483
TAH8072	7314150307487	1	483
TAH8072C	7314150383641	1	483
TAH8073	7314150319831	1	483
TAH8073C	7314150383658	1	483
TAH8074	7314150319848	1	483
TAH8074C	7314150383665	1	483
TAH8075	7314150307500	1	483
TAH8075C	7314150383672	1	483
TAH8150-1/2	7314150309283	1	487
TAH8158B-1	7314150309290	1	487
TAH8160	7314150306367	1	487
TAH8162	7314150306374	1	487
TAH8166	7314150306381	1	487
TAH8224	7314150307951	1	492
TAH84-PODGER	7314150312221	1	483
TAH868700000	7314150374571	1	494
TAH8950N/A	7314150309382	1	488
TAH8953	7314150309399	1	488
TAH8961	7314150309405	1	488
TAH9045-B-250	7314150411634	1	497



TAH9048-250	7314150411627	1	497
TAH9070	7314150307517	1	483
TAH9072	7314150307524	1	483
TAHBE-8020L	7314150308101	1	488
TAHBE-8030	7314150308118	1	488
TAHBE-8040	7314150308125	1	488
TAHBE-8040S	7314150308132	1	489
TAHBE-8050S	7314150308149	1	489
TAHBE-8155	7314150308156	1	488
TAHBE-8220S	7314150308163	1	489
TAHBE-8241	7314150308217	1	488
TAHBE-8252	7314150308224	1	488
TAHBE-8255S	7314150320226	1	489
TAHBE-8257	7314150308231	1	488
TAHBE-8258	7314150308248	1	488
TAHBE-8260	7314150308255	1	489
TAHBE-8350	7314150308262	1	489
TAHBE-8602	7314150308279	1	489
TAHBE-8610	7314150308286	1	489
TAHBE-8610S	7314150308293	1	490
TAHBE-8611	7314150308309	1	489
TAHBE-8620	7314150308316	1	489
TAHBE-8620L	7314150308323	1	489
TAHBE-8620S	7314150308330	1	490
TAHBE-8623	7314150308347	1	489
TAHBE-8624	7314150308354	1	489
TAHBE-8630	7314150308361	1	489
TAHBE-8630S	7314150320233	1	490
TAHBE-8640S	7314150320240	1	490
TAHBE-8810	7314150308378	1	489
TAHBE-8820	7314150308385	1	489
TAHBE-8820SL	7314150347827	1	490
TAHBE-8830	7314150308392	1	489
TAHBE-8880	7314150432196	1	489
TAHBE-8910	7314150343713	1	489
TAHBE-8910S	7314150343799	1	490
TAHBE-8915	7314150343744	1	489
TAHBE-8915S	7314150343805	1	490
TAHBE-8920	7314150343751	1	489
TAHBE-8920S	7314150343812	1	490
TAHBE-8925	7314150343768	1	489
TAHBE-8925S	7314150343829	1	490
TAHBE-8930	7314150343775	1	489
TAHBE-8930S	7314150343836	1	490
TAHBE-9776	7314150432233	1	490
TAHBE-9777B	7314150307685	1	491
TAHBE-9787	7314150307692	1	491
TAHBE64520	7314150307821	1	499
TAHBFRL11	7314150307739	1	499
TAHBOD5400	7314150339457	1	499
TAHBOD5450	7314150339464	1	499
TAHCRW01	7314150432370	1	492
TAHCS300	7314150411603	1	497
TAHLTS-30	7314150432387	1	496
TAHMK5	7314150411580	1	485
TAHPINRELEASER	7314150307838	1	488
TAHSC2RM-13-17	7314150339792	1	485
TAHSC2RM-15-17	7314150339785	1	485
TAHSC2RM-19-22	7314150339761	1	485
TAHSC2RM-27-30	7314150339778	1	485
TAHSCB140G	7314150308071	1	494
TAHSR300-MM	7314150415021	1	497
TAHWBB600	7314150440429	1	496
TAHWBB700	7314150440436	1	496
TAM12135	7314150215331	1	117
TAM12200	7314150215348	1	117
TAM12340	7314150215355	1	117
TAM1430	7314150215317	1	117
TAM38135	7314150215324	1	117
TAS14H007	7314150423187	1	113
TAS14H09	7314150423200	1	113
TAS14S007	7314150423194	1	113
TAS14S09	7314150423217	1	113
TASMB14H007	7314150489664	1	113
TASMB14H09	7314150489671	1	113
TAW12340	7314150274963	1	107
TAW1412M	7314150423156	1	107
TAW1430M	7314150422289	1	107
TAW14340	7314150340842	1	107
TAW24800	7314150368297	1	107
TAW34800	7314150285471	1	107
TAW38135	7314150274956	1	107
TAW38135M	7314150502295	1	107
TAW912M	7314150423163	1	107
TAW9135	7314150340859	1	107
TAW9135M	7314150502288	1	107
TAW930M	7314150422319	1	107
TAWM12340	7314150274925	1	106
TAWM1412M	7314150423149	1	106



TAWM1430M	7314150422265	1	106
TAWM14340	7314150340835	1	106
TAWM24800	7314150368280	1	106
TAWM34800	7314150274932	1	106
TAWM38135	7314150274918	1	106
TAWM38135M	7314150502264	1	106
TAWM912M	7314150423132	1	106
TAWM9135	7314150340828	1	106
TAWM9135M	7314150502271	1	106
TAWM930M	7314150422241	1	106
TAWMB14340	7314150489626	1	106
TAWMB24650	7314150490103	1	106
TAWMB24800	7314150489633	1	106
TAWMB9135M	7314150490110	1	106
TAWMB930M	7314150489640	1	106
TEA003	7314150422180	1	116
TEA010	7314150422197	1	116
TEA030	7314150465781	1	116
TEA065	7314150472246	1	116
TEA1100	7314150423170	1	116
TEA2100	7314150465972	1	116
TEA350	7314150422210	1	116
TJS003	7314150522477	1	116
TJS010	7314150522484	1	116
TJS030	7314150522491	1	116
TR0325M03X-50	7314150501632	5	148
TR0636M06X-65	7314150501663	5	148
TR0650M06X-80	7314150501694	5	148
TR0860M08X-110	7314150507269	5	148
TR4.530M06X-90	7314150501755	5	148
TSS120	7314150347063	1	114
TSS600	7314150346414	1	114
W-S-1.5	7311518140816	4	616
W-S-2.0	7311518140823	4	616
W-S-2.5	7311518140830	4	616
W-T-2.0	7311518140847	4	616
WBB1000	7314150431502	4	626
WBB1200	7314150431519	4	626
WBB1500	7314150431526	1	626
WBB400	7314150315215	10	626
WBB500	7314150315222	10	626
WBB600	7314150315239	10	626
WBB700	7314150315246	6	626
WBB800	7314150340972	6	626
WBF380	7314150315253	12	626
WBMF190	7314150315260	24	627
WBMF190IP	7314150457960	15	627
WBP-3P-30MF	7314150444335	1	627
WBP-3P-963	7314150444328	1	627
WBP300	7314150315161	20	626
WBP500	7314150315178	12	626
WBP625	7314150315185	12	626
WBP710	7314150315192	10	626
WBP900	7314150315208	6	626
WC-HOL	7314150333158	1	587
WPH 2-50	7314150520428	1	623
WPH 3-20	8412814125435	1	623
WPH 3-30	8412814125442	1	623
WR1	7314150167425	50	557
WR1-MM	7314150220069	50	557
WR2	7314150167432	25	557
WR2-12	7314150185627	25	557
WR2-MM	7314150220038	25	557
XLARGE	7314150437412	1	435
XXL	7314150504152	1	434
ZHVIDEOBAT	8414909180244	1	362
ZHVIDEOCHA	8414909180237	1	362



KONTAKTUPPGIFTER

Argentina

A.M. de Justo 1750 3° A
C1107AFJ - Capital Federal
Buenos Aires
Tel: +54 (11) 4313-1004
Fax: +54 (11) 4893-3553

Australia

3 Cooper Street, Smithfield,
NSW 2164
Tel: +61 (0) 2 8787 5700
Fax: +61 (0) 2 9756 6130

Беларусь

ЗАО "Эс-Эн-Эй Европа Индастриз Бисов"
220075 СЭЗ "Минск"
ул. Селицкого, д. 8А
Телефон +375 (17) 389 79 50
info.by@snaeurope.com

Belgium

Branch of SNA Europe (Benelux) BV
De Kleetlaan 12А Pegasus Park
1831 DIEGEM
Tel: +32 (0)2 726 03 03
info.be@bahco.com

Chile

Av. Americo Vesputio 2760-D
Conchali - Santiago - Chile
Tel: + 56 2 623 0203
Fax: + 56 2 623 5395

Česká republika

SNA Europe s.r.o.
Holadnská 2/4
639 00 Brno
Tel: +420 537 022 520
Fax: +420 537 022 200

Danmark

Vallensbækvej 40,
2605 Brøndby
Tel: +45 4363 0330
Fax: +45 4396 2456

Deutschland

Willetstraße 10
40822 Mettmann
Tel: +49 (0) 2104 833 83 0
Fax: +49 (0) 2104 833 83 7999

España

c/ Hilanderas, 1
(P.O. Box / Ardo de Correos nº 5)
C.P. 20303 Irún
Tel: +34 902 235 100 / +34 943 649 111
Fax: +34 943 649 120

Ελλάδα

Λ. Βουλιαγμένης 604Γ
167 77 Ελληνικό, Αθήνα
Τηλ: +30 210 9914263
Fax: +30 210 9914587

Export

Antigua Carretera de Altube Km 5,5
P.O.Box 307
01080 VITORIA (Spain)
Tel: +34 945269711
Fax: +34 945165040

France

ZAC de l'Hoirie
20 rue Charles Lacretelle
CS 60101
49072 Beaucouzé cedex
Tél: +33 (0) 2 41 22 98 40
Fax: +33 (0) 2 41 22 98 50

Italia

SNA EUROPE Italia S.p.A.
Via Georges Bizet, 13/15
20092 Cinisello Balsamo MI - Italia
Tel. +39 02 3024161
info.it@snaeurope.com

Казахстан

050000, Алматы,
ул.Шевченко 1656/72г, оф.217
Тел/факс +7 727323 63 39

Nederland

Vossenbeemd 113
5705 CL Helmond
Tel: +31 (0) 492 58 23 82
info.nl@bahco.com

New Zealand

Unit 3/25 Highbrook Drive
East Tamaki
Auckland
Tel: +64 9-273 46 50
Fax: +64-9-273-2453

Norge

Box 800
1306 Sandvika
Tel: +47 40 49 66 00
Fax: +47 67 17 56 51

Österreich

Vienna, Nineteen, Mooslackengasse 17
A - 1190 Wien
Tel: +49 (0) 2104 8 33 83 0
Fax +49 (0) 2104 833 83 79 99

Polska

ul. Marynarska 15
02-674 Warszawa
Tel.: +48 (0) 22 6070510
Fax: +48 (0) 22 6070521

Россия

000 "Эс-Эн-Эй Юроп (РУС)"
141407 г. Химки
ул. Панфилова вл.21, стр.1
Телефон +7 (495) 221 58 51
info.ru@snaeurope.com

Portugal

SNA Europe [Industries] LDA
R. Maria Julia M. Ramos - Junqueira
4480-254 Vila Do Conde
Tel. +351 252 650 131
Fax. +351 252 650 160

Slovenská republika

SNA Europe s.r.o.
Karadžičova 8/A
821 08 Bratislava
Tel: +421 (0)2 5939 6124
Fax: +421 (0)2 5939 6217

SRBIJA

Vermax-alati doo
Ul. Drage Spasić 35
11000 Beograd
Tel: +381 11 2360 500
Tel: +381 11 2360 900
Fax: +381 11 2361 147
e-mail: office@vermax.rs

Suomi

SNA Europe Oy
PL 6580
00002 Helsinki
Finland
Tel: +358 207 433 510
Fax: +358 207 433 525

Sverige

SNA Europe Industries AB
Box 83
SE-745 22 Enköping
Tel: +46 (0) 171-47 82 00
Fax: +46 (0) 171-47 82 38

Schweiz / Suisse

Willetstraße 10
40822 Mettmann
Tel: +49 (0) 2104 833 83 0
Fax: +49 (0) 2104 833 83 7999

Türkiye

Girne Mah. Maltepe Küçük San. Sitesi
F Blok No:19 Maltepe
Istanbul
Tel: +90 (0) 216 367 10 21
Fax: +90 (0) 216 367 11 71

Украина

«Бахко Бисов Свенска Акциеболаг»
SNA Europe [Ukraine & Moldova]
Телефон +38 067 441 16 09
офис 555, улица Армянская, 6А
Киев, Украина

United Kingdom

Moorhead Way, Bramley,
Rotherham, South Yorkshire S66 1YY
Tel: +44 (0) 1709 731731
Fax: +44 (0) 1709 731741

GARANTI

Information om garantin hittar du på din lokala webbplats www.bahco.com



Denna katalog innehåller vårt aktuella produktsortiment. Ändringar i sortimentet, liksom form, design och modellbeteckningar, sker fortlöpande. Särskild information om sådana ändringar lämnas inte.

Illustrationer och teckningar har återgivits så exakt som möjligt. Avvikelse kan emellertid förekomma. Detta gäller även tekniska specifikationer.

Viktangivelser är ungefärliga och tjänar i första hand till att underlätta beräkningar av frakt- och portokostnader.

Denna katalog ersätter samtliga tidigare specifikationer och sortimentskataloger.

Katalogen är SNA Europes egendom. Utdrag, eftertryck och kopior av innehållet får göras med tillstånd från oss.

2023



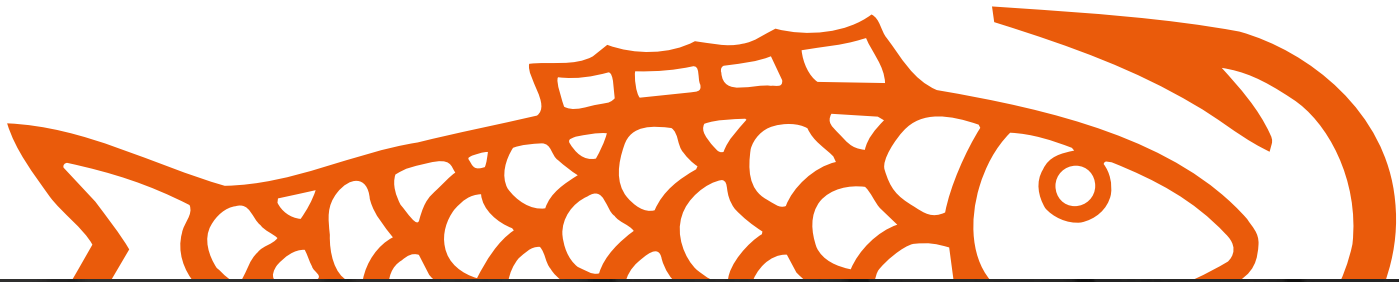

www.bahco.com

M-039-CAT-23



7 314150 534869 >