

UK

WRKPRO

Professional work lighting by Diesella



CONTENT

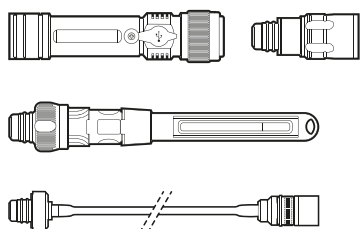

WORK LIGHT

03

Professional Work lights for the Work shop, the control room and general Work lighting

PRODUCT OVERVIEW 10-11

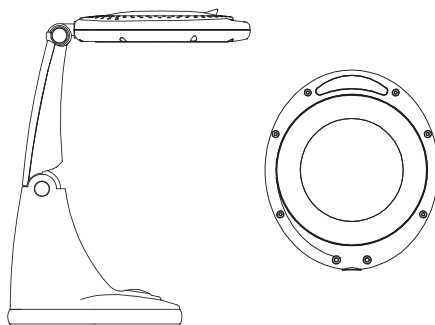

MAGNIFYING LAMPS

14

Strong LED magnifying lamps for testing and inspection

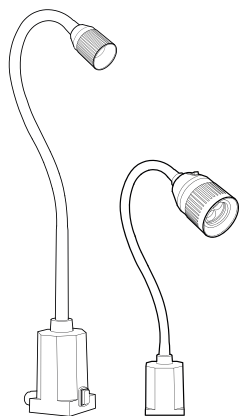

MACHINE LIGHT

17

Strong LED light and accessories for machine lighting on small machines, Work stations and similar

PRODUCT OVERVIEW 30-33

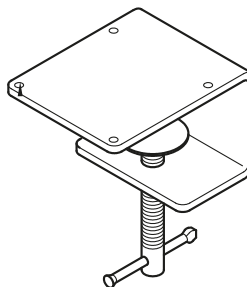

ACC. MACHINE LIGHT

28

Mounts, universal mounts and table mounts

WRKPRO SLIM X6
ART. 50616130



WORK LIGHT

Professional Work lights for the Work shop, the control room and/or general Work lighting

**LED Work lights • Portable/ handheld • Mounting
Magnetic base • Flashlight • Rechargeable**

WRKPRO

WORK LIGHT



WRKPRO LIGHT M1

ART. 50618410

Handheld Work lamp With CREE XPG LED With 2 adjustable brightnesses, flexible arm and focus/zoom-function for a quick and easy light source adjustment. Magnetic base and a rechargeable Li-Ion battery.



WRKPRO LIGHT SLIM X1

ART. 50616050

IP54 mini hand lamp With very powerful OSRAM LED With 2 adjustable brightnesses and flashlight. Rechargeable Li-Ion battery, hook/clip function and magnetic base.



WRKPRO LIGHT M3

ART. 50618420

IP65 Work lamp With powerful magnetic base and tiltable COB LED light source Which makes it extremely easy to adapt the light to the task. Built-in hook function for hanging on various surfaces or Wires. Rechargeable Li-Ion battery.



WRKPRO LIGHT H1/H2/H3

H1: ART. 50617210
H2: ART. 50617220
H3: ART. 50617230

Hand lamp With COB LED, 2 adjustable brightnesses, flashlight and a strong magnet inside the base. Tilttable stand. Rechargeable Li-Ion battery With battery indicator, hook and clips for hanging.
Note: H1 only has one belt clip.



SPECS

Item no.	Name	Battery	Max output	Min. output	IP class	Size mm	Weight	Run time
50618410	M1	3.7V 2200 mAh	250 lumen	125 lumen	IP54	30 × 20 × 650	286 g	4 - 9 hours
50616050	X1	3.7V 1500 mAh	500 lumen	60 lumen	IP54	106.5 × 42 × 25	86 g	4 - 10 hours
50618420	M3	3.7V 2600 mAh	600 lumen	300 lumen	IP65	78 × 76 × 72	225 g	2 - 3.5 hours
50617210	H1	3.7V 750 mAh	150 lumen	50 lumen	IP54	158 × 30 × 23	84 g	2 - 4 hours
50617220	H2	3.7V 2200 mAh	240 lumen	50 lumen	IP54	173 × 54 × 34	195 g	3 - 13 hours
50617230	H3	3.7V 4400 mAh	420 lumen	50 lumen	IP54	190 × 60 × 32	264 g	3 - 8 hours

F1

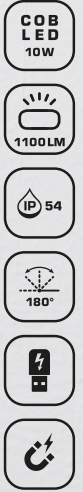

WRKPRO LIGHT F1

ART. 50615100

Compact, portable Work lamp With 10W COB LED, rechargeable and removable Li-Ion battery With LED flash light, USB input and a powerful, tiltable stand With strong magnet.



SPECS

Item no.	Name	Battery	Max output	Min. output	IP class	Size mm	Weight	Run time
50615100	F1	3.7V 4400 mAh	1100 lumen	400 lumen	IP54	186 × 165 × 46	730 g	3 - 6 hours

WORK LIGHT



1 BASE
 Battery: 3.7V 2200 mAh
 IP class: IP54
 Size: 138 x 33 mm
 Weight: 170 g

2 FLASHLIGHT
 Max. output: 280 Lm
 Size: 34 x 60 mm
 Light distance: 150 m
 Weight: 68 g

3 WORK LAMP
 Max. output: 350 Lm
 Size: 35 x 230 mm
 Weight: 87 g

4 FLEXIBLE 360°
 Max. output: 200 Lm
 Size: 19 x 433 mm
 Weight: 103 g



WORK LIGHT SET MX5 IN PORTABLE SUITCASE

ART. 50618450

3-in-1 Work lamp in anodized aluminium With 2 adjustable brightnesses and zoom-function. The set consists of **1:** Magnetic base and rechargeable Li-Ion battery. **2:** Flashlight With CREE LED and focus function. **3:** 180° tiltable COB LED light. **4:** 360° flexible lamp With CREE LED and focus function.

Portable suitcase included.

SPECS

Item no.	Name	Battery	Max output	Min. output	IP class	Size mm	Weight	Run time
50618450	MX5	3.7V 2200 mAh	350 lumen	180 lumen	IP54	See description	238-273 g	6 hours



SLIM X4

BESTSELLER

WRKPRO LIGHT SLIM X4

ART. 50616110

Compact, foldable Work lamp With powerful COB LED With 2 adjustable brightnesses and SMD LED flashlight. The COB light can be rotated 180° horizontally and vertically. Rechargeable Li-Ion battery. Strong magnet at the bottom incl. hook function.



180°

180°



WRKPRO LIGHT SLIM X5

ART. 50616120

Compact Work lamp With powerful COB LED, 2 adjustable brightnesses and SMD LED flashlight. Flexible swan neck light head that can be rotated/bent 360° horizontally and vertically. Rechargeable Li-Ion battery. Strong magnet at the bottom incl. hook function.

SPECS

Item no.	Name	Battery	Max output	Min. output	IP class	Size mm	Weight	Run time
50616110	X4	3.7V 2600 mAh	700 lumen	60 lumen	IP54	66 × 45 × 423	290 g	2 - 16 hours
50616120	X5	3.7V 2600 mAh	500 lumen	50 lumen	IP54	423 × 66 × 45	290 g	2 - 16 hours

WRKPRO

Professional work lighting by Diesella



WORK LIGHT



WRKPRO FLASHLIGHT N1

ART. 50619110

Flashlight in a simple, elegant but powerful design that is resistant to harsh shocks. The flashlight has an ideal size for all types of tasks. The lamp has focus control with single-hand sliding operation, XP-G2 Cree White LED and 5 light functions. Turbo (up to 450Lm), high (300Lm), medium (150Lm), low (20Lm) and 8Hz flash.



WRKPRO FLASHLIGHT N2

ART. 50619160

Rechargeable flashlight in a simple, elegant but powerful design resistant to harsh shocks. The flashlight has an ideal size for all types of tasks. The flashlight has focus control with single-hand sliding operation, XP-L Cree White LED and 5 light functions. Turbo (up to 450Lm), high (300Lm), medium (150Lm), low (20Lm) and 8Hz flash.



WRKPRO HEADLIGHT Q1

ART. 50620250

Headlight in a simple, clean but powerful design to resist harsh shocks and is suitable for both everyday use and for work. The headlight has dual lights LED and 6 lighting modes. White LED with adjustable brightness; High (up to 230Lm), Medium (100Lm), Low (20lm), 3Hz Flashing and Nightvision red LED with SOS-Flashing.



WRKPRO HEADLIGHT Q2











ART. 50620280

Headlight in a simple, clean but powerful design to resist harsh shocks and is suitable for both everyday use and for work. The headlight has XP-G2 Cree White LED - High (up to 320Lm), Medium (145Lm), Low (18Lm) and 2Hz flash. Focus control by twisting lens ring and intelligent motion sensor remote control. Lumen can be controlled remotely from 100%-5%.

SPECS





Item no.	Name	Battery	Max output	Min. output	IP class	Size mm	Weight	Run time
50619110	N1	4 x 1.5V AAA	450 lumen	20 lumen	IP66	Ø38 x 129	172 g	1 - 45 hours
50619160	N2	1 x 3.7 Li-ion battery	450 lumen	20 lumen	IP66	Ø29 x 141	166 g	4 - 50 hours
50620250	Q1	3 x 1.5V AAA	230 lumen	5 lumen	IP64	62 x 46 x 40	90 g	5 - 100 hours
50620280	Q2	3 x AAA or rechargeable	320 lumen	18 lumen	IP64	67 x 46 x 45	108 g	5.5 - 60 hours

PRODUCT OVERVIEW

Product	Item no.	Name	IP class	Battery	Max. output	Min. output	LED source
	50615100	F1	IP54	3,7V 4400 mAh Li-Ion	1100 lumen	400 lumen	COB 10W
	50617210	H1	IP54	3,7V 4400 mAh Li-Ion	300 lumen	20 lumen	SMD LED
	50617220	H2	IP54	3,7V 2000 mAh Li-Ion	500 lumen	100 lumen	COB LED
	50617230	H3	IP44	7,4V 4000 mAh Li-Ion	2000 lumen	50 lumen	COB 20W
	50618420	M3	IP54	3,7V 2600 mAh Li-Ion	700 lumen	60 lumen	COB LED
	50616050	SLIM X1	IP54	3,7V 2600 mAh Li-Ion	500 lumen	50 lumen	COB LED
	50618410	M1	IP54	3,7V 2600 mAh Li-Ion	700 lumen	60 lumen	COB LED
	50618450	MX5	IP54	3,7V 2200 mAh Li-Ion	350 lumen	180 lumen	COB/SMD LED
	50616110	SLIM X4	IP54	3,7V 2600 mAh Li-Ion	700 lumen	60 lumen	COB LED
	50616120	SLIM X5	IP54	3,7V 2600 mAh Li-Ion	500 lumen	50 lumen	COB LED

Run time	Magnetic	Brightness levels	Drop resistance	Charging time	Product size	Weight
3-6 hours	Yes	2	-	6 hours	186 × 165 × 46 mm	730 g
8 - 15 hours	Yes	4	-	5 hours	89.5 × 85 × 83.5 mm	329 g
2 - 4 hours	Yes	2	1 m	3 hours	148 × 55 × 21 mm	188 mm
1 - 24 hours	Yes	5	1 m	4,5 hours	233 × 230 × 62 mm	1.565 kg
2 - 16 hours	Yes	2 + flashlight	2 m	4 hours	66 × 45 × 423 mm	290 g
2 - 16 hours	Yes	2 + flashlight	2 m	4 hours	423 × 66 × 45 mm	290 g
1.5 - 16 hours	Yes	-	2 m	4 hours	384 × 45 × 40 mm	250 g
6 hours	Yes	2 + zoom	-	6 hours	∅33 × 133 + ∅34 × 60/ ∅35 × 230 + ∅19 × 430 mm	238 - 273 g
2 - 16 hours	Yes	2 + flashlight	2 m	4 hours	66 × 45 × 423 mm	290 g
2 - 16 hours	Yes	2 + flashlight	2 m	4 hours	423 × 66 × 45 mm	290 g

PRODUCT OVERVIEW

Product	Item no.	Name	IP class	Battery	Max. output	Min. output	LED source
	50619110	N1	IP66	4 × 1,5V AAA Alkaline	450 lumen	20 lumen	CREE LED
	50619160	N2	IP66	3,7V 2600 mAh Li-Ion	1000 lumen	50 lumen	CREE LED
	50620250	Q1	IP64	3 × 1,5V AAA Alkaline	230 lumen	20 lumen	Luxeon TX LED
	50620280	Q2	IP64	3 × 1,5V AAA Alkaline/ 3,7V 800 mAh Li-Polymer	320 lumen	18 lumen	XP-G2 CREE

Run time	Magnetic	Brightness levels	Drop resistance	Charging time	Product size	Weight
1-45 hours	No	5 + focus	2 m	-	Ø38 × 129 mm	172 g
4-50 hours	No	5 + focus	2 m	4 hours	Ø29 × 141 mm	166 g
5-100 hours	No	5 + SOS	2 m	-	62 × 46 × 40 mm	90 g
5,5-60 hours	No	4 + focus	2 m	-	67 × 46 × 45 mm	108 g



WRKPRO ELECTRO

ART. 15406565



ESD APPROVED

ELECTRO and *SCORPIO* are ESD-safe which prevents static charging.

QUICK-CHANGE

A new system which makes it fast and easy to change the magnification to your needs. *You'll only need one lamp for all tasks.*

MAGNIFYING LAMPS

Strong LED magnifying lamps for testing and inspection

**3D/5D dioptrre • 5D dioptrre • Chick Change • ESD Approved
Loose/ integrated dust flap • Table mount**

WRKPRO

COSMO

NEW IN!



COSMO



ART. 15406410 - Ø127 mm
ART. 15406445 - Ø178 mm

QUICK-CHANGE

LENSES FOR COSMO



Ø127 mm

ART. 15406825 - 3D
ART. 15406830 - 5D
ART. 15406835 - 8D

Ø178 mm

ART. 15406840 - 3D
ART. 15406845 - 5D



LED MAGNIFYING LAMP WITH 3D + 5D LENSES

Magnifying lamp with a 3D lens pre-installed (1.75X) and an extra 5D lens (2.25X) which can be replaced. AC 230V power supply. With 1.5 m cord incl. plug.

Ø127 mm: 60 pcs. Super Bright SMD LEDs/1200 Lm
Ø178 mm: 80 pcs. Super Bright SMD LEDs/1600 Lm

Color: White. Arm length: 410+410 mm. CE certified.
Delivered with a robust table clamp.

QUICK CHANGE LENSES

Lenses suitable for COSMO. Easily replaced using the smart **Quick-Change** system. A new system that makes it easy and quick to change the magnification according to work task and needs.

Note: 8D lens can be purchased for 15406410.

SPECS

Item no.	Name	Lens size	External diameter	Dioptre	Power consumption	Lumen	Height / Weight
15406410	COSMO	Ø127 mm	Ø217 mm	3D (1.75X)+5D (2.25X)	12 W	1200 Lm	820 cm / 3.90 kg
15406825	LENS	Ø127 mm	Ø217 mm	3D (1.75X)	-	-	0.42 kg
15406830	LENS	Ø127 mm	Ø217 mm	5D (2.25X)	-	-	0.56 kg
15406835	LENS	Ø127 mm	Ø217 mm	8D (3.00X)	-	-	0.68 kg
15406445	COSMO	Ø178 mm	Ø272 mm	3D (1.75X)+5D (2.25X)	16 W	1600 Lm	820 cm / 5.80 kg
15406840	LENS	Ø178 mm	Ø272 mm	3D (1.75X)	-	-	1.08 kg
15406845	LENS	Ø178 mm	Ø272 mm	5D (2.25X)	-	-	1.40 kg

SCORPIO

NEW IN!



ESD APPROVED

SCORPIO



ART. 15406510 - Ø127 mm
ART. 15406540 - Ø178 mm



ESD APPROVED

QUICK-CHANGE

LENSES FOR SCORPIO



Ø127 mm

ART. 15406860 - 3D
ART. 15406865 - 5D
ART. 15406870 - 8D

Ø178 mm

ART. 15406875 - 3D
ART. 15406880 - 5D



ESD LED MAGNIFYING LAMP WITH 3D+5D LENSES

Magnifying lamp made of special ESD-conducting material that prevents static charging. With pre-installed 3D lens (1.75X) and an additional 5D lens (2.25X), which can be replaced. AC 230V power supply. With 1.5 m cord incl. plug.

Ø127 mm: 60 pcs. Super Bright SMD LEDs / 1200 Lm
Ø178 mm: 80 pcs. Super Bright SMD LEDs / 1600 Lm

Colour: Black. Arm length: 410 + 410 mm. CE certified.
Deliveres with robust table clamp.



QUICK CHANGE LENSES

Lenses suitable for SCORPIO. Easily replaced using the smart Quick-Change system. A new system that makes it easy and quick to change the magnification according to work task and needs.

Note: 8D lens can be purchased for 15406510.

SPECS

Item no.	Name	Lens size	External diameter	Dioptre	Power consumption	Lumen	Height / Weight
15406510	SCORPIO	Ø127 mm	Ø217 mm	3D (1.75X)+5D (2.25X)	12 W	1200 Lm	820 cm / 3.90 kg
15406860	LENS	Ø127 mm	Ø217 mm	3D (1.75X)	-	-	0.42 kg
15406865	LENS	Ø127 mm	Ø217 mm	5D (2.25X)	-	-	0.56 kg
15406870	LENS	Ø127 mm	Ø217 mm	8D (3.00X)	-	-	0.68 kg
15406540	SCORPIO	Ø178 mm	Ø272 mm	3D (1.75X)+5D (2.25X)	16 W	1600 Lm	820 cm / 5.80 kg
15406875	LENS	Ø178 mm	Ø272 mm	3D (1.75X)	-	-	1.08 kg
15406880	LENS	Ø178 mm	Ø272 mm	5D (2.25X)	-	-	1.40 kg

ELECTRO

NEW IN!



ESD APPROVED

ELECTRO 

ART. 15406565 - 3D
ART. 15406575 - 5D



ESD APPROVED

LENSES FOR ELECTRO 

ART. 15406885 - 3D
ART. 15406890 - 5D



ESD LED MAGNIFYING LAMP

Magnifying lamp with an extra large retangulated field of view. The lamp is made of ESD conductive material, which prevents static charging. The flexible arm of 820 mm with 3 links provides a large working radius. With 1.5m cord incl. plug.

Color: Black. Arm length: 410+410mm. CE certified.
Delivered with a robust table clamp.



LENSES

3D and 5D lenses for ELECTRO.

SPECS

Item no.	Name	Lens size	External diameter	Dioptre	Power consumption	Lumen	Height / Weight
15406565	ELECTRO	189 × 157 mm	300 × 215 mm	3D	12 W	1200 Lm	820 mm / 3.50 kg
15406885	LENS	189 × 157 mm	300 × 215 mm	3D	-	-	1.08 kg
15406575	ELECTRO	189 × 157 mm	300 × 215 mm	5D	12 W	1200 Lm	820 mm / 4.00 kg
15406890	LENS	189 × 157 mm	300 × 215 mm	5D	-	-	1.40 kg

MAGNIFYING LAMPS

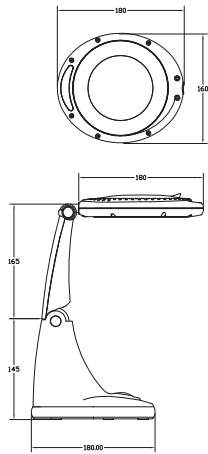

FLUX CE

ART. 15406085

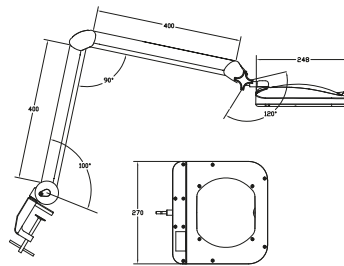

SIRIUS CE

ART. 15406195 - 3D
ART. 15406200 - 5D

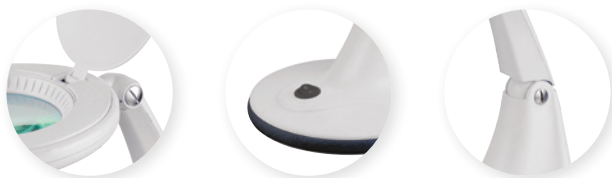

LED MAGNIFYING LAMP TABLE MODEL WITH Ø9 LENS

Magnifying lamp table model. With Ø9cm lens, 6W power and 30×SMD LED light source. On and off button on the base. Integrated dust flap. 3D dioptre (= 1.75X magnification) and 220V~240V power connection. **Colour:** White. **Height:** 35 cm. **Weight:** 1.1 kg. **Lumen:** 570Lm. **RA value:** >80. CE certified.



LED MAGNIFYING LAMP WITH 19×16 CM LENS

Magnifying lamp with 19×16 cm lens, 10W power and 60×SMD LED light source. On and off button on the head. Integrated dust flap. Available with 3D dioptre (= 1.75X magnification) og 5D dioptre (=2.25X magnification). 220V~240V power connection. 1.5 m cable incl. plug. **Colour:** White. **Height:** 80 cm. **Weight:** 3.9 kg. **Lumen:** 950Lm. **RA value:** >80. CE certified.
Table mount included.

SPECS

Item no.	Name	Lens size	External diameter	Dioptre	Power consumption	Lumen	Height /weight
15406085	FLUX	Ø9cm	155 × 180mm	3D (=1.75X)	6W	570Lm	35 cm / 1.1 kg
15406195	SIRIUS	19 × 16 cm	270 × 250mm	3D (=1.75X)	10W	950Lm	80 cm / 3.9kg
15406200	SIRIUS	19 × 16 cm	270 × 250mm	5D (=2.25X)	10W	950Lm	80 cm / 3.9kg



WRKPRO LYRA
ART. 50530230

MACHINE LIGHT

Strong LED light and accessories for machine lighting on
small machines, Work stations and similar

**LED machine light • Fixed/flexible arm • Adjustable brightness
Fixed mounting • Magnetic mounts**

WRKPRO

LED MACHINE LIGHT

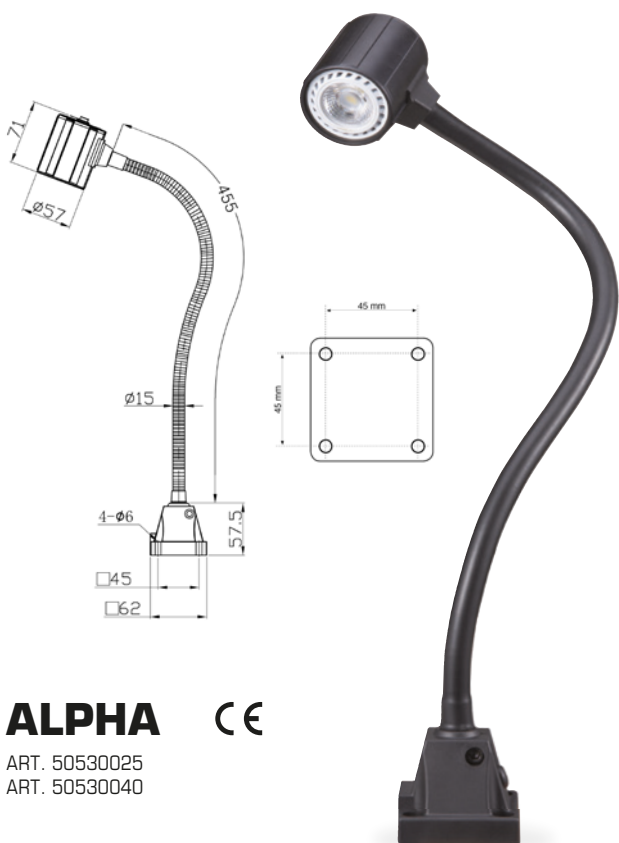

ALPHA

ART. 50530025
ART. 50530040

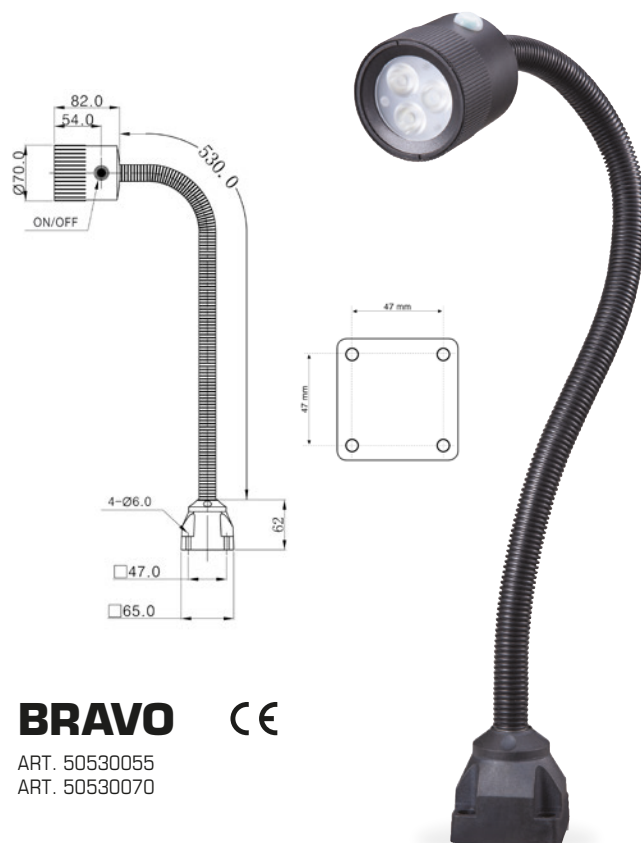

BRAVO

ART. 50530055
ART. 50530070



IP30 MACHINE LIGHT WITH FLEXIBLE ARM

1 pcs. LED bulb mounted at 90° flexible arm. The arm measures 455mm and is protected by nitrile rubber. Hole pitch 45x45mm. Lamp head of black anodised aluminium with long life - approx. 50,000 hours, and minimum heat in the lamp. This ensures the lamp glass is not discoloured by burnt oil or similar. On and off button behind the head. 320 lumen. CE certified.

IP65 MACHINE LIGHT 4.5W

For lighting on small machines, Work stations and similar. Lamp head with 3 pcs. LED bulbs mounted on a 530mm flexible arm, which is protected by a plastic cover. Lamp head of black anodised aluminium with long life - approx. 50,000 hours and minimum heat in the lamp. This ensures the lamp glass is not discoloured by burnt oil or similar. On and off button on the head. 320 lumen. CE certified.

See further specifications at page 32 – 35

See further specifications at page 32 – 35

SPECS

Item no.	Volts	Density	Arm length	Lumen	Spread	Power consumption	LED quantity	Hole pitch
50530025	AC/DC 24V	IP30	455mm	320Lm	45°	5W	1 pcs.	45 × 45mm
50530040	230V AC	IP30	455mm	320Lm	45°	5W	1 pcs.	45 × 45mm
50530055	AC/DC 24V	IP65	530mm	320Lm	60°	4.5W	3 pcs.	47 × 47mm
50530070	230V AC	IP65	530mm	320Lm	60°	4.5W	3 pcs.	47 × 47mm

LED MACHINE LIGHT



DELTA

ART. 50531210
ART. 50531220

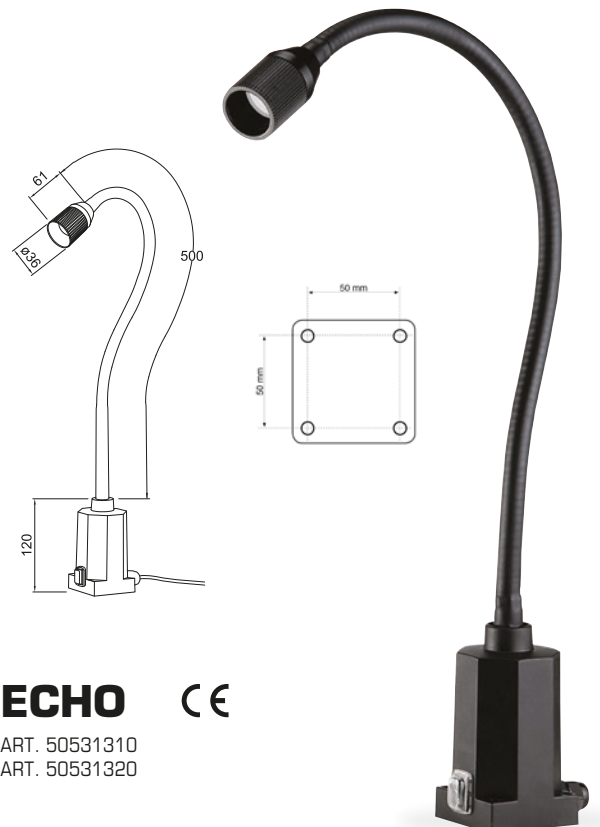

ECHO

ART. 50531310
ART. 50531320



IP20 LED MACHINE LIGHT WITH SWAN NECK AND TILTABLE HEAD

Lamp With tiltable head ideal for Workshop or office. Very low heat. Plastic lamp head With 3 pcs. LED bulbs mounted on a 455 mm swan arm, Which is protected by nitrile rubber. On and off button on the head. 510 lumen. CE certified.



IP65 LED MACHINE LIGHT WITH 500 MM FLEXIBLE ARM

Lamp With fixed focus and 1 pcs. LED light source in aluminum housing. High intensity and low energy consumption. Very low heat. The arm is 500 mm and protected by nitrile rubber. On and off button on the base. 220 lumen. CE certified.

See further specifications at page 32 – 35

See further specifications at page 32 – 35

SPECS

Item no.	Volts	Density	Arm length	Lumen	Spread	Power consumption	LED quantity	Hole pitch
50531210	AC/DC 24V	IP20	455mm	510Lm	30°	6W	3 pcs.	60 × 60mm
50531220	AC 100V-240V	IP20	455mm	510Lm	30°	6W	3 pcs.	60 × 60mm
50531310	AC/DC 24V	IP65	500mm	220Lm	40°	3W	1 pcs.	50 × 50mm
50531320	AC 100V-240V	IP65	500mm	220Lm	40°	3W	1 pcs.	50 × 50mm

LED MACHINE LIGHT



HELA CE

ART. 50531410
ART. 50531420



IP65 LED MACHINE LIGHT WITH FLEXIBLE SWAN NECK

Lamp With tiltable head ideal for Workshop or office. Very low heat. Aluminium lamp housing With plastic cover and hand grip. Consists of 3 pcs. LED bulbs. The arm is 500mm and black anodised. On and off button behind the head. 510 lumen. CE certified.

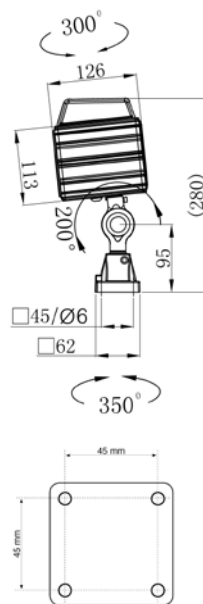

LEO CE

ART. 50530110
ART. 50530120



IP65 LED MCH. LIGHT WITH SHORT ARM

Strong LED lamp supplied With 8 pcs. LED bulbs, With very long life - approx. 50.000 hours and minimum heat in the lamp. The lamp head is made of hard anodised aluminium. Total height: 280mm. On and off button under the head. Working temperature: -20 to +45°C. 830 lumen. CE certified.

See further specifications at page 32 – 35

See further specifications at page 32 – 35

SPECS

Item no.	Volts	Density	Arm length	Lumen	Spread	Power consumption	LED quantity	Hole pitch
50531410	AC/DC 24V	IP65	500mm	510Lm	30°	6W	3 pcs.	60 × 60mm
50531420	AC 100V-240V	IP65	500mm	510Lm	30°	6W	3 pcs.	60 × 60mm
50530110	AC/DC 24V	IP65	Total højde: 280mm	830Lm	45°	9,5W	8 pcs.	45 × 45mm
50530120	AC 100V-240V	IP65	Total højde: 280mm	830Lm	45°	9,5W	8 pcs.	45 × 45mm

LED MACHINE LIGHT

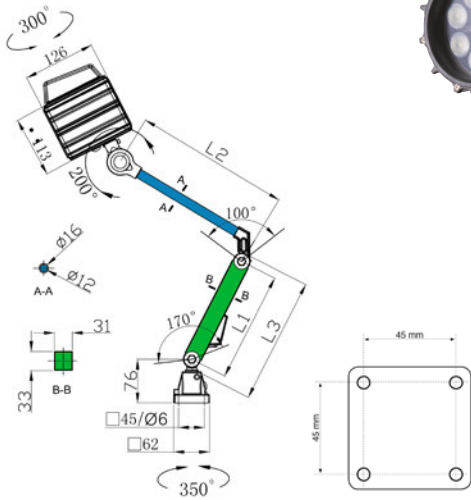

LYRA

ART. 50530230
ART. 50530240

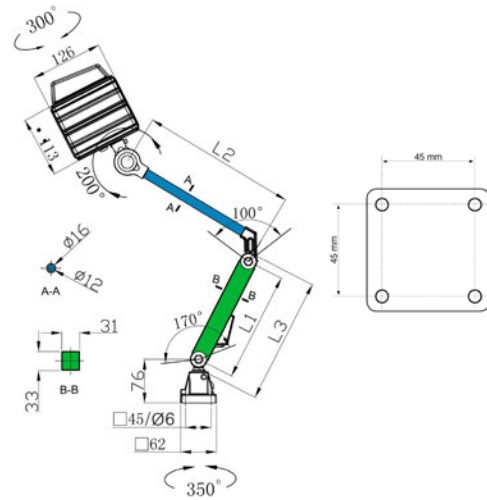

LIMA

ART. 50530255
ART. 50530265

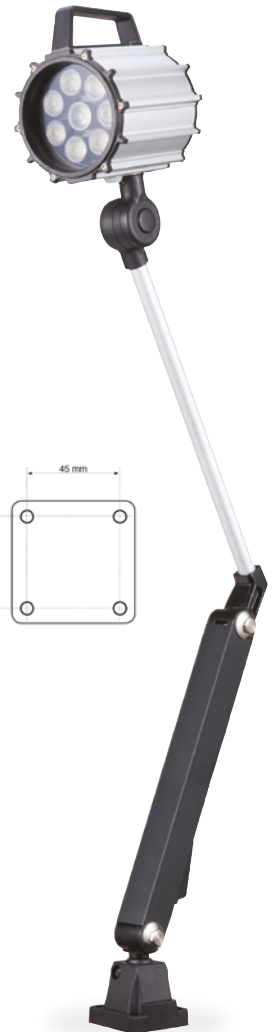

IP65 LED MCH. LIGHT WITH LONG ARM

Strong LED lamp supplied With 8 pcs. LED bulbs, With very long life - approx. 50.000 hours and minimum heat in the lamp. The lamp head and arms are made of hard anodised aluminium With joints, Which can be tightened. Arm length: 190+270mm. On and off button under the head. Working temperature: -20 to +45°C. 830 lumen. CE certified.



IP65 LED MACHINE LIGHT WITH EXTRA LONG ARM

Strong Work lamp With 400+400mm arm. Supplied With 8 pcs. LED bulbs With very long life - approx. 50.000 hours and minimum heat in the lamp. The lamp head and arms are made of hard anodised aluminium With joints, Which can be tightened. On and off button under the head. Working temperature: -20 to +45°C. 830 lumen. CE certified.

See further specifications at page 32 – 35

See further specifications at page 32 – 35

SPECS

Item no.	Volts	Density	Arm length	Lumen	Spread	Power consumption	LED quantity	Hole pitch
50530230	AC/DC 24V	IP65	190×270mm	830Lm	45°	9,5 W	8 pcs.	45×45mm
50530240	AC 100V-240V	IP65	190×270mm	830Lm	45°	9,5 W	8 pcs.	45×45mm
50530255	AC/DC 24V	IP65	400×400mm	830Lm	45°	9,5 W	8 pcs.	45×45mm
50530265	AC 100V-240V	IP65	400×400mm	830Lm	45°	9,5 W	8 pcs.	45×45mm

LED MACHINE LIGHT

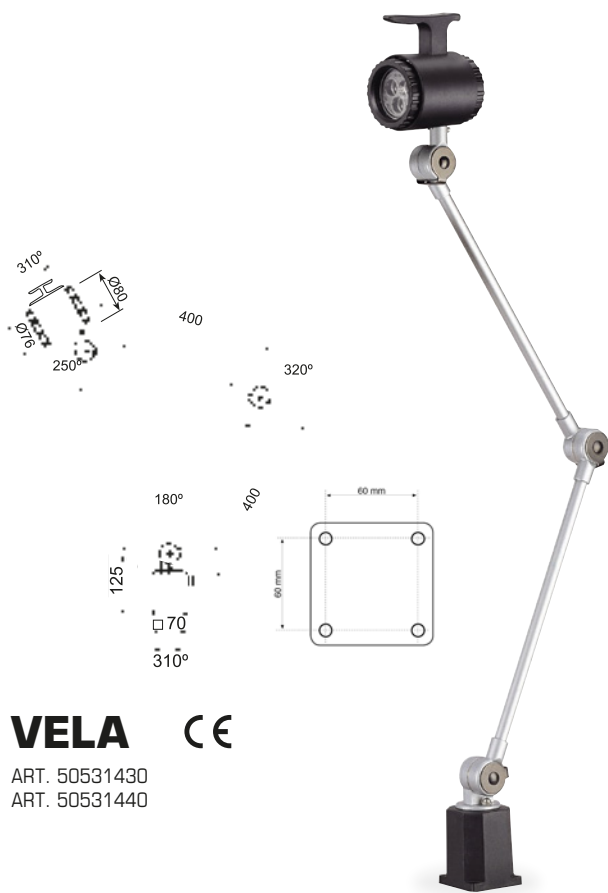

VELA

ART. 50531430
ART. 50531440



IP65 LED MACHINE LIGHT WITH 400+400 MM ARM

Ideal lamp With tiltable head and a long range. Consists of 3 pcs. LED bulbs in aluminium housing With plastic cover and hand grip. Lacquered aluminium arm 400+400 mm in length. On and off button behind the head. 510 lumen. CE certified.

See further specifications at page 32 – 35

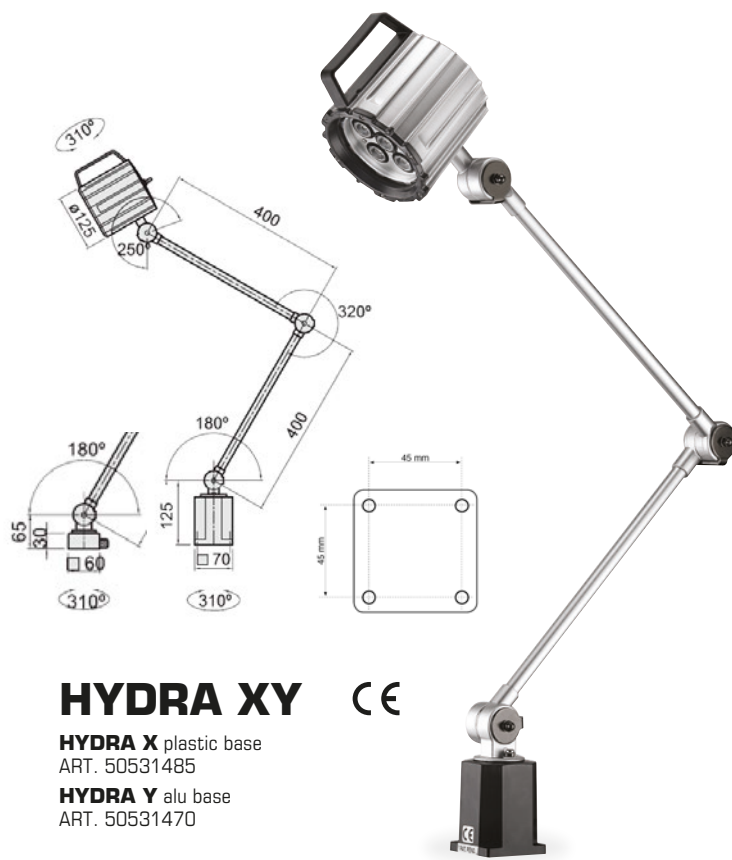

HYDRA XY

HYDRA X plastic base
ART. 50531485
HYDRA Y alu base
ART. 50531470



STRONG 12W LED IP65 MACHINE LIGHT

For the professional Workshop. IP65 classification, large lamp With 6 pcs. LED bulbs mounted on a strong 400x400 mm lacquered aluminium arm. Note: Strong ABS plastic base With 4xM6 screw holes With hole pitch of 60x60 mm on model 50531485 and aluminium base With hole pitch of 45x45 mm on model 50531470. On and off button behind the head. 1020 lumen. CE certified.

See further specifications at page 32 – 35

SPECS

Item no.	Volts	Density	Arm length	Lumen	Spread	Power consumption	LED quantity	Hole pitch
50531430	AC/DC 24V	IP65	400x400mm	510Lm	30°	6W	3 pcs.	60x60mm
50531440	AC 100V-240V	IP65	400x400mm	510Lm	30°	6W	3 pcs.	60x60mm
50531470	AC/DC 24V	IP65	400x400mm	1.020Lm	60°	12W	6 pcs.	45x45mm
50531485	AC 100V-240V	IP65	400x400mm	1.020Lm	60°	12W	6 pcs.	60x60mm

LED MACHINE LIGHT

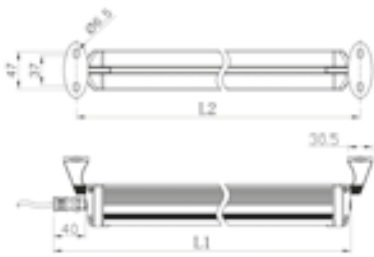

Model	L1	L2
50530325 / 50530340	474mm	400-450mm
50530355 / 50530370	674mm	590-650mm

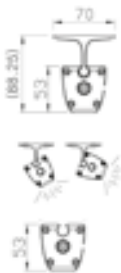

QUEBEC

ART. 50530325 / 50530340
ART. 50530355 / 50530370

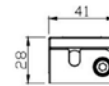
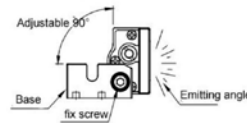
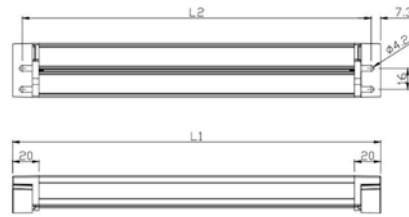

ORION

ART. 50530420
ART. 50530465

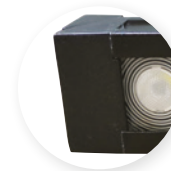
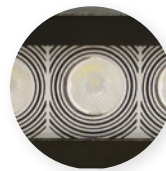
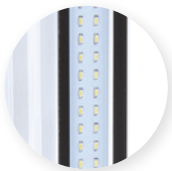

IP65 LED RECESSED LIGHT - OVAL

For fixed mounting With horizontal/ vertical mounts on processing machines, on Work and assembly sites and so on. The lamp housing is mounted in hardened glass and produced in hard anodised aluminium, ensuring a long life. The mounts can be tightened to secure the lamp at a suitable angle of 0-180 degrees, for perfect lighting. Working temperature: -20 to +45°C. CE certified.

See further specifications at page 32 – 35

IP65 MACHINE LIGHT/ RECESSED LIGHT - FLAT

Machine lighting for fixed mounting. Particularly suitable for machines With limited space. Finished in hard anodised aluminium With integrated heating for long life. The metal mounts can be tightened to secure the lamp at a suitable angle of 0-120 degrees for perfect lighting. Working temperature: -20 to +45°C. CE certified.

See further specifications at page 32 – 35

SPECS

Item no.	Volts	Density	Length	Lumen	Spread	Power consumption	Kelvin	Hole pitch
50530325	AC/DC 24V	IP65	400mm	1.080 Lm	120°	12 W	4.000-4.500	37-47mm
50530340	AC 100V-240V	IP65	400mm	1.080 Lm	120°	12 W	4.000-4.500	37-47mm
50530355	AC/DC 24V	IP65	600mm	1.440 Lm	120°	16 W	4.000-4.500	37-47mm
50530370	AC 100V-240V	IP65	600mm	1.440 Lm	120°	16 W	4.000-4.500	37-47mm
50530420	AC/DC 24V	IP65	280mm	635 Lm	60°	8 W	4.000-4.500	255-265 mm
50530465	AC/DC 24V	IP65	580mm	1.500 Lm	60°	20 W	4.000-4.500	555-565 mm

LED MACHINE LIGHT

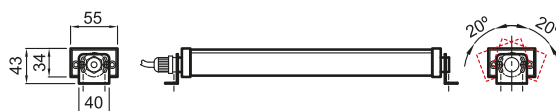
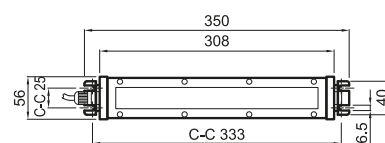
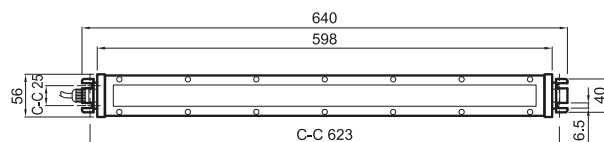
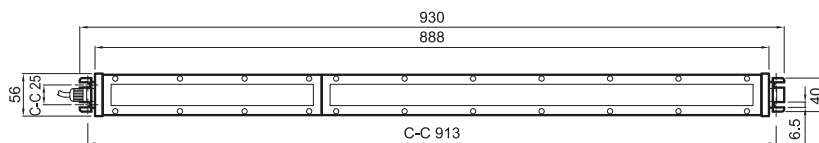

VEGA

ART. 50532710
ART. 50532720
ART. 50532730

ULTRA THIN IP67 LED MACHINE LIGHT – FLAT FORM

Ultra thin recessed LED machine light With aluminium housing. The perfect choice for mounting and installation. Available in 3 different length (350mm/14W, 640mm/28W, 930mm/42W). IP67 level of protection. The lamp housing is produced in hard anodised aluminium With unbreakable glass, ensuing a long life - up to 40.000 hours. Free from infrared rays and ultraviolet radiation. Supplied With 1.8 m cable With no plug. DC24V power connection. Working temperature: -30 to +50°C. CE certified.

See further specifications at page 32 – 35

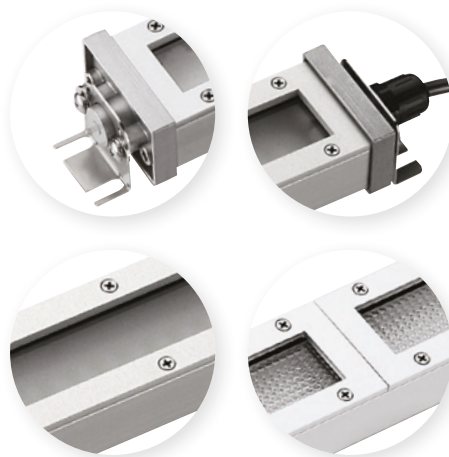

SPECS

Item no.	Volts	Density	Length	Lumen	Spread	Power consumption	Kelvin
50532710	DC 24V	IP67	350mm	1.870Lm	120°	14 W	5.700 Kelvin
50532720	DC 24V	IP67	640mm	3.740Lm	120°	28 W	5.700 Kelvin
50532730	DC 24V	IP67	930mm	5.610Lm	120°	42 W	5.700 Kelvin

LED MACHINE LIGHT

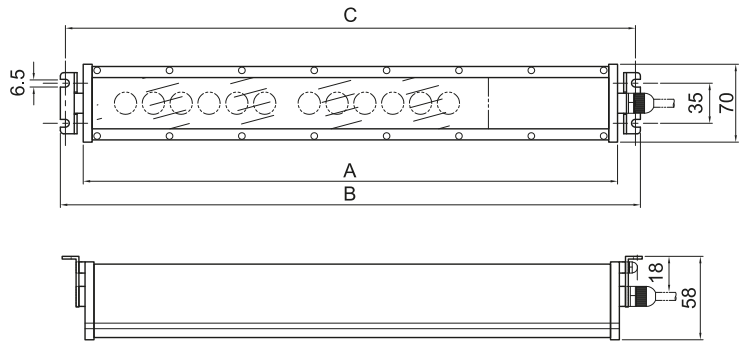

Model	A	B	C
50532610 / 50532620	480mm	522mm	516mm
50532630 / 50532640	835mm	877mm	871mm

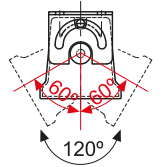

VICTOR CE

ART. 50532610 / 50532620
ART. 50532630 / 50532640

NARROW IP67 LED MACHINE LIGHT – OVAL FORM

Strong recessed LED machine light With aluminium housing. The lamp housing is produced in hard anodised aluminium ensuring a long life - up to 40.000 hours. Each LED bulb is 2W. Available in two different lengths: 515mm/24W and 870mm/40W. High efficiency and strong light - model 50532630 and 50532640 supplies 3040 lumen. A 1.8 m cable is supplied With all models and plugs With models With AC 100V-240V power connection. CE certified.



See further specifications at page 32 – 35

SPECS

Item no.	Volts	Density	Length	Lumen	Spread	Power consumption	LED quantity
50532610	AC/DC 24V	IP67	515mm	2.040Lm	80°	24W	12 pcs.
50532620	AC 100V-240V	IP67	515mm	2.040Lm	80°	24W	12 pcs.
50532630	AC/DC 24V	IP67	870mm	3.040Lm	80°	40W	20 pcs.
50532640	AC 100V-240V	IP67	870mm	3.040Lm	80°	40W	20 pcs.

LED WORK LAMPS



FOXTROT CE

ART. 50531610



X-RAY CE

ART. 50531625



IP50 LED WORK LAMP WITH FLEXIBLE LAMP HEAD

Strong Work lamp for the Workshop, control room and/or general Work lighting, Where there is a particular need for flexibility regarding positioning and light strength. 378 mm rotatable lamp head With 14W LED light tube, supplying 1440 lumen. The light strength can be adjusted from 10-100% on the arm. Lamp head in anodised aluminium With lacquered aluminium arms. On and off button on the arm. CE certified.

See further specifications at page 32 – 35



IP50 LED WORK LAMP WITH 628 MM LAMP HEAD

Strong Work lamp for the Workshop, control room and/or general Work lighting, Where there is a particular need for flexibility regarding positioning and light strength. 628 mm rotatable lamp head With 28W LED light tubes, supplying 2880 lumen. The light strength can be adjusted from 10-100% on the arm. Lamp head in anodised aluminium With lacquered aluminium arms. On and off button on the arm. CE certified.

See further specifications at page 32 – 35

SPECS

Item no.	Volts	Density	Arm length	Lumen	Spread	Power consumption	Lamp head	Hole pitch
50531610	AC 100V-240V	IP50	400 × 430 mm	1.440 Lm	120°	14 W	378 mm	45 × 45 mm
50531625	AC 100V-240V	IP50	400 × 430 mm	2.880 Lm	120°	28 W	628 mm	45 × 45 mm

LED WORK LAMPS

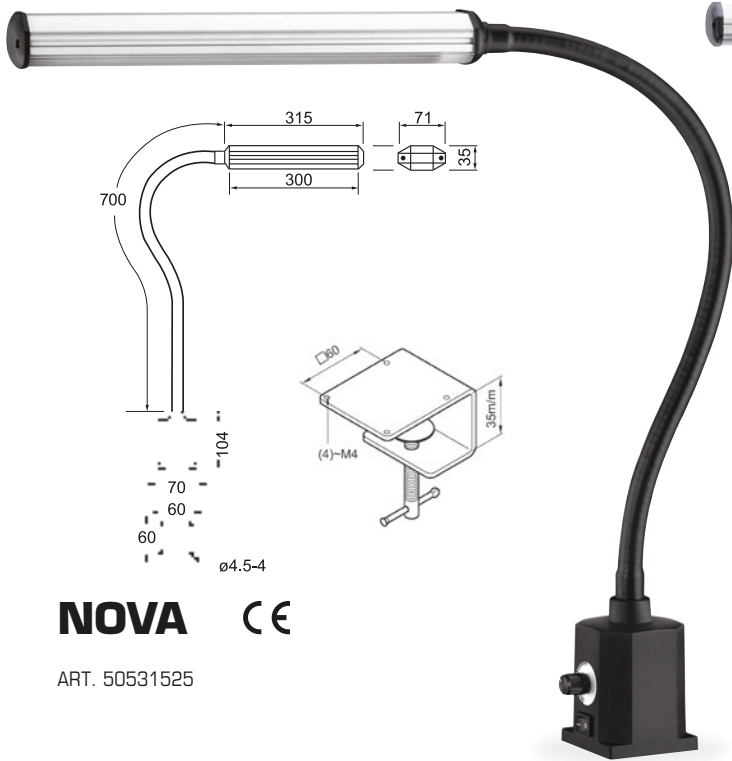

NOVA CE

ART. 50531525

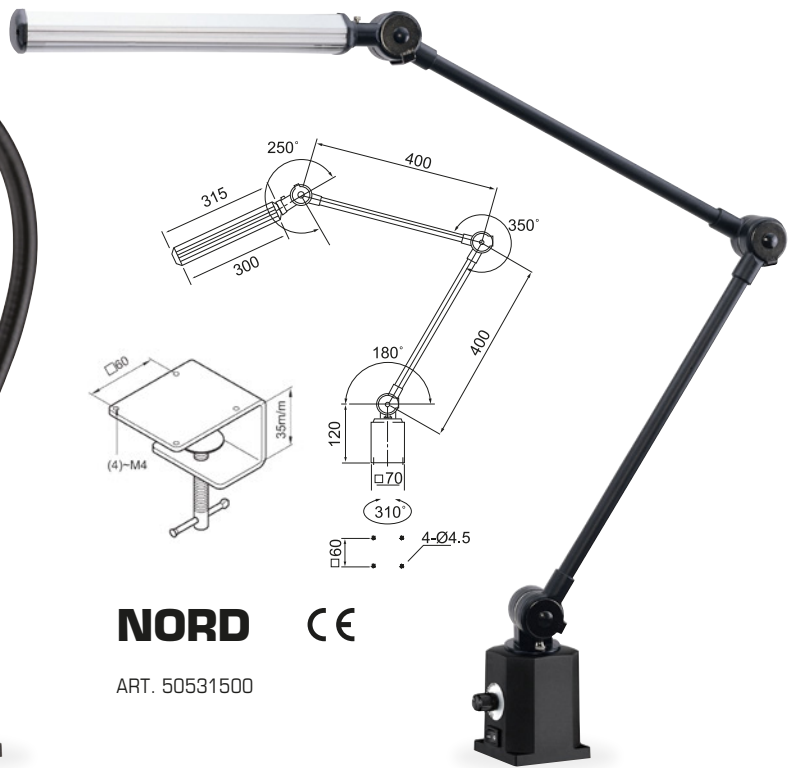

NORD CE

ART. 50531500



IP50 LED WORK LAMP 700 MM FLEXIBLE ARM AND DIMMABLE LIGHT SOURCE

Practical Work lamp With adjustable light strength from 10-100%. Lamp head in aluminium With nitrile rubber cover on the arm. The long flexible arm allows you to position the light at the exact angle you need. Table clamp included. On and off button on the base. 1870 lumen. CE certified.



IP50 LED WORK LAMP WITH DIMMABLE LIGHT SOURCE

Ideal for precision Work tasks in the Workshop, in production or in the office. Strong 400x400 mm arm in black lacquered aluminium With 300 mm light fitting. The light strength can be adjusted from 10-100%. Very low heat. On and off button on the base. 1820 lumen. CE certified.

See further specifications at page 32 – 35

See further specifications at page 32 – 35

SPECS

Item no.	Volts	Density	Arm length	Lumen	Spread	Power consumption	Kelvin	Hole pitch
50531525	AC 100V-240V	IP50	700mm	1.870Lm	120°	14 W	5.700	60 × 60 mm
50531500	AC 100V-240V	IP50	400 × 400 mm	1.820 Lm	120°	14 W	5.700	60 × 60 mm

MOUNTS

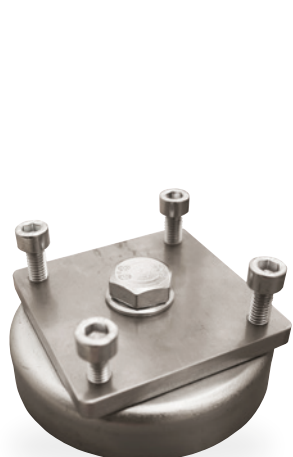

ART. 50530490
ART. 50530495

MAGNETIC MOUNT FOR MACHINE LIGHT

Magnetic mount Ø80 mm for 45 × 45 mm or 47 × 47 mm mounting.



ART. 50531912

MAGNETIC MOUNT

Magnetic mount Ø102 mm With hole pitch 50 × 50 mm.



ART. 50531910

MAGNETIC MOUNT

Magnetic mount Ø102 mm With hole pitch 60 × 60 mm.

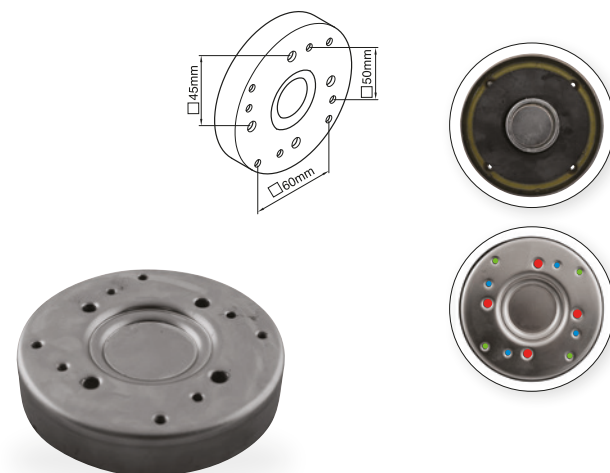

UNIVERSAL MAGNETIC MOUNT ART. 50531914

Universal magnetic mount Ø102 mm With 3 different hole pitches. Hole pitch: 45 × 45 mm / 50 × 50 mm / 60 × 60 mm.

SPECS

Item no.	Size	Type	Mounting	Suitable for machine light type
50530490	Ø80 mm	Magnetic mount	45 × 45 mm	ALPHA / LEO / LYRA / LIMA / HYDRA / FOXTROT / X-RAY
50530495	Ø80 mm	Magnetic mount	47 × 47 mm	BRAVO
50531910	Ø102 mm	Magnetic mount	60 × 60 mm	DELTA / HELA / VELA / HYDRA X / NORD / NOVA
50531912	Ø102 mm	Magnetic mount	50 × 50 mm	ECHO
50531914	Ø102 mm	Universal magnetic mount	45 × 45 mm 50 × 50 mm 60 × 60 mm	ALPHA / LEO / LYRA / LIMA / HYDRA / FOXTROT / X-RAY ECHO / DELTA / HELA / VELA / HYDRA X / NORD / NOVA

MOUNTS

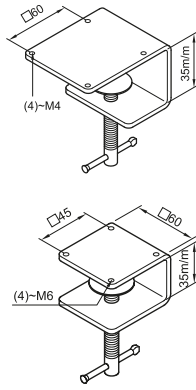

ART. 50531920 - 60 × 60 mm
 ART. 50531922 - 50 × 50 mm
 ART. 50531924 - 45 × 45 mm

TABLE MOUNTS FOR MACHINE LIGHT

Table mounts for machine lights. Available With hole pitch of 60 × 60 mm / 50 × 50 mm / 45 × 45 mm.

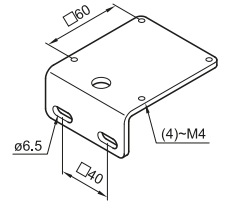

ART. 50531930











WALL MOUNTS FOR MACHINE LIGHTS

Wall mounts for machine lights With hole pitch of 60 × 60 mm.

SPECS

Item no.	Size	Type	Mounting	Suitable for machine light type
50531920	-	Table mounts	60 × 60 mm	DELTA / HELA / VELA / HYDRA X / NORD / NOVA
50531922	-	Table mounts	50 × 50 mm	ECHO
50531924	-	Table mounts	45 × 45 mm	ALPHA / LEO / LYRA / LIMA / HYDRA / FOXTROT / X-RAY
50531930	-	Wall mounts	60 × 60 mm	DELTA / HELA / VELA / HYDRA X / NORD / NOVA

PRODUCT OVERVIEW

Product	Item no.	Name	IP density	Power connection	Power consumption	Light spread	Lumen
	50530025	ALPHA	IP30	AC/DC 24V	5W	45°	320Lm
	50530040	ALPHA	IP30	AC 100V-240V	5W	45°	320Lm
	50530055	BRAVO	IP65	AC/DC 24V	4.5W	60°	320Lm
	50530070	BRAVO	IP65	AC 100V-240V	4.5W	60°	320Lm
	50531210	DELTA	IP20	AC/DC 24V	6W	30°	510Lm
	50531220	DELTA	IP20	AC 100V-240V	3W	30°	510Lm
	50531310	ECHO	IP65	AC/DC 24V	3W	40°	220Lm
	50531320	ECHO	IP65	AC 100V-240V	6W	40°	220Lm
	50531410	HELA	IP65	AC/DC 24V	6W	30°	510Lm
	50531420	HELA	IP65	AC 100V-240V	6W	30°	510Lm
	50530110	LEO	IP65	AC/DC 24V	9.5W	45°	830Lm
	50530120	LEO	IP65	AC 100V-240V	9.5W	45°	830Lm
	50530230	LYRA	IP65	AC/DC 24V	9.5W	45°	830Lm
	50530240	LYRA	IP65	AC 100V-240V	9.5W	45°	830Lm
	50530255	LIMA	IP65	AC/DC 24V	9.5W	45°	830Lm
	50530265	LIMA	IP65	AC 100V-240V	9.5W	45°	830Lm
	50531430	VELA	IP65	AC/DC 24V	6W	30°	510Lm
	50531440	VELA	IP65	AC 100V-240V	6W	30°	510Lm
	50531470	HYDRA Y <i>alu base</i>	IP65	AC/DC 24V	12W	60°	1.020Lm
	50531485	HYDRA X <i>plastic base</i>	IP65	AC 100V-240V	12W	60°	1.020Lm

RA VALUE

The RA value indicates how well the light reflects colour. Daylight has an RA value of 100, an incandescent light bulb has 99. The RA value of LED bulbs is typically between 80 and 97.

**FIND THE RIGHT
LED BULB**



Kelvin	LED quantity	RA value	Fastening holes	Hole pitch	Cable length	Length
4.000-4.500	1 pcs.	>80	4 × M6	45 × 45 mm	1.8 m (no plug)	455 mm
4.000-4.500	1 pcs.	>70	4 × M6	45 × 45 mm	2.0 m (incl. EU plug)	455 mm
4.000-4.500	3 pcs.	>70	4 × M6	47 × 47 mm	2.0 m (no plug)	530 mm
4.000-4.500	3 pcs.	>70	4 × M6	47 × 47 mm	2.0 m (incl. EU plug)	530 mm
5.700	3 pcs.	>80	4 × M4	60 × 60 mm	1.8 m (no plug)	455 mm
5.700	3 pcs.	>80	4 × M4	60 × 60 mm	1.8 m (incl. EU plug)	455 mm
5.700	1 pcs.	>80	4 × M4	50 × 50 mm	1.8 m (no plug)	500 mm
5.700	1 pcs.	>80	4 × M4	50 × 50 mm	1.8 m (incl. EU plug)	500 mm
5.700	3 pcs.	>80	4 × M4	60 × 60 mm	1.8 m (no plug)	500 mm
5.700	3 pcs.	>80	4 × M4	60 × 60 mm	1.8 m (incl. EU plug)	500 mm
4.000-4.500	8 pcs.	>70	4 × M6	45 × 45 mm	2.0 m (no plug)	Total height: 280 mm
4.000-4.500	8 pcs.	>70	4 × M6	45 × 45 mm	2.0 m (incl. EU plug)	Total height: 280 mm
4.000-4.500	8 pcs.	>70	4 × M6	45 × 45 mm	2.0 m (no plug)	190 × 270 mm
4.000-4.500	8 pcs.	>70	4 × M6	45 × 45 mm	2.0 m (incl. EU plug)	190 × 270 mm
4.000-4.500	8 pcs.	>70	4 × M6	45 × 45 mm	2.0 m (no plug)	400 × 400 mm
4.000-4.500	8 pcs.	>70	4 × M6	45 × 45 mm	2.0 m (incl. EU plug)	400 × 400 mm
5.700	3 pcs.	>80	4 × M4	60 × 60 mm	1.8 m (no plug)	400 × 400 mm
5.700	3 pcs.	>80	4 × M4	60 × 60 mm	1.8 m (incl. EU plug)	400 × 400 mm
5.700	6 pcs.	>80	4 × M4	45 × 45 mm	1.8 m (no plug)	400 × 400 mm
5.700	6 pcs.	>80	4 × M4	60 × 60 mm	1.8 m (incl. EU plug)	400 × 400 mm









LUMEN

Lumen refers to the amount of light a bulb gives off. If you need to use something that is equivalent to the old 40-Watt light bulb, you should choose a bulb that emits 470 lumen.

KELVIN

A Warm light has 2400-2900 Kelvin, Which is equivalent to an incandescent light bulb. The higher the number, the Whiter and more bluish the light appears. The lower the number, the more red and yellow is in the colour of the light. LED = 2000 to 8000K.

PRODUCT OVERVIEW

Product	Item no.	Name	IP density	Power connection	Power consumption	Light spread	Lumen
	50531525	NOVA	IP50	AC 100V-240V	14 W	120°	1.870Lm
	50531500	NORD	IP50	AC 100V-240V	14 W	120°	1.820 Lm
	50531610	FOXTROT	IP50	AC 100V-240V	14 W	120°	1.440Lm
	50531625	X-RAY	IP50	AC 100V-240V	28 W	120°	2.880 Lm
	50530325	QUEBEC	IP65	AC/DC 24V	12 W	120°	1.080Lm
	50530340	QUEBEC	IP65	AC 100V-240V	16 W	120°	1.080 Lm
	50530355	QUEBEC	IP65	AC/DC 24V	16 W	120°	1.440Lm
	50530370	QUEBEC	IP65	AC 100V-240V	16 W	120°	1.440 Lm
	50530420	ORION	IP65	AC/DC 24V	8 W	60°	635Lm
	50530465	ORION	IP65	AC/DC 24V	20 W	60°	1.500 Lm
	50532710	VEGA	IP67	DC 24V	14 W	120°	1.870Lm
	50532720	VEGA	IP67	DC 24V	28 W	120°	3.740 Lm
	50532730	VEGA	IP67	DC 24V	42 W	120°	5.610Lm
	50532610	VICTOR	IP67	AC/DC 24V	24 W	80°	2.040 Lm
	50532620	VICTOR	IP67	AC 100V-240V	24 W	80°	2.040Lm
	50532630	VICTOR	IP67	AC/DC 24V	40 W	80°	3.040 Lm
	50532640	VICTOR	IP67	AC 100V-240V	40 W	80°	3.040Lm

RA VALUE

The RA value indicates how well the light reflects colour. Daylight has an RA value of 100, an incandescent light bulb has 99. The RA value of LED bulbs is typically between 80 and 97.

FIND THE RIGHT LED BULB



Kelvin	LED quantity	RA value	Fastening holes	Hole pitch	Cable length	Length
5.700 Dimmable 10-100%	-	>80	4 × M4	60 × 60 mm	1.8 m cable With plug and table mount	700 mm flex. arm
5.700 Dimmable 10-100%	-	>80	4 × M4	60 × 60 mm	1.8 m cable With plug and table mount	400 × 400 mm
5.700	-	>80	4 × M6	45 × 45 mm	1.8 m (incl. EU plug)	400 × 430 mm
5.700	-	>80	4 × M6	45 × 45 mm	1.8 m (incl. EU plug)	400 × 430 mm
4.000-4.500	-	>80	4 × M6	37-47 mm	2.0 m (no plug)	400 mm
4.000-4.500	-	>80	4 × M6	37-47 mm	2.0 m (incl. EU plug)	400 mm
4.000-4.500	-	>80	4 × M6	37-47 mm	2.0 m (no plug)	600 mm
4.000-4.500	-	>80	4 × M6	37-47 mm	2.0 m (incl. EU plug)	600 mm
4.000-4.500	8 pcs.	>80	4 × M4	255-265 mm	1.0 m (no EU plug)	280 mm
4.000-4.500	18 pcs.	>80	4 × M4	555-565 mm	1.0 m (no EU plug)	580 mm
5.700	-	>80	4 × M6	25 mm	1.8 m (no plug)	350 mm
5.700	-	>80	4 × M6	25 mm	1.8 m (no plug)	640 mm
5.700	-	>80	4 × M6	25 mm	1.8 m (no plug)	930 mm
5.700	12 pcs.	>80	4 × M6	35 mm	1.8 m (no plug)	515 mm
5.700	12 pcs.	>80	4 × M6	35 mm	1.8 m (incl. EU plug)	515 mm
5.700	20 pcs.	>80	4 × M6	35 mm	1.8 m (no plug)	870 mm
5.700	20 pcs.	>80	4 × M6	35 mm	1.8 m (incl. EU plug)	870 mm

LUMEN

Lumen refers to the amount of light a bulb gives off. If you need to use something that is equivalent to the old 40-Watt light bulb, you should choose a bulb that emits 470 lumen.

KELVIN

A Warm light has 2400-2900 Kelvin, Which is equivalent to an incandescent light bulb. The higher the number, the Whiter and more bluish the light appears. The lower the number, the more red and yellow is in the colour of the light. LED = 2000 to 8000K.

WRKPRO

Professional work lighting by Diesella